

3-INPUT 2-OUTPUT VIDEO SWITCH

■ GENERAL DESCRIPTION

The NJM2279 is 3-input 2-output video switch that can be used in a single or dual power supply. It includes 6dB amplifier, 75ohm driver circuit and independent 2-Output mute.

■ FEATURES

- Operating Voltage (Dual) $\pm 4.0V$ to $\pm 7.0V$ (Single) $+8.0V$ to $+14V$
- 3-input 2-output Video Switch
- Internal 6dB Amplifier
- Internal 75 Ω Driver Circuit
- Independent 2-Output Mute
- Bipolar Technology
- Package Outline DIP14, DMP14

■ RECOMMENDED OPERATING CONDITION

- Supply Voltage (Dual) $\pm 4.0V$ to $\pm 7.0V$ (Single) $+8.0V$ to $+14V$

■ BLOCK DIAGRAM

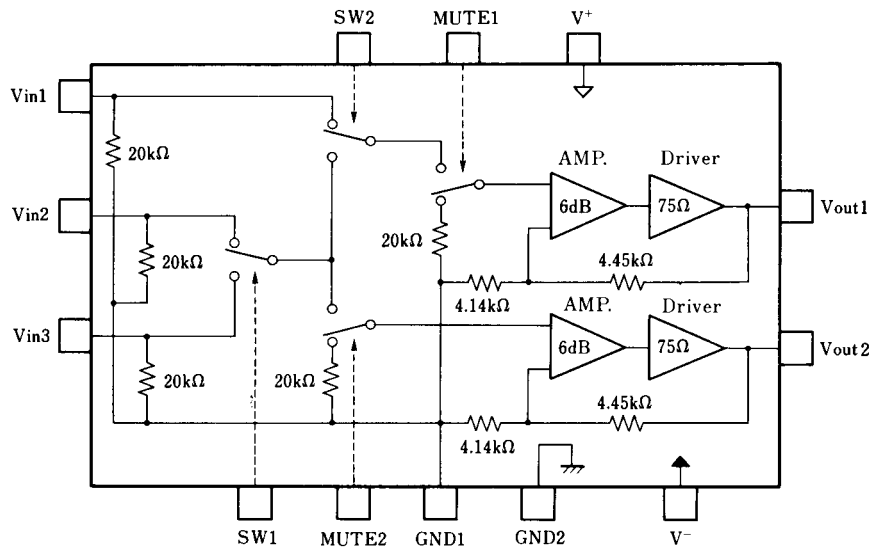

■ PIN CONFIGURATION

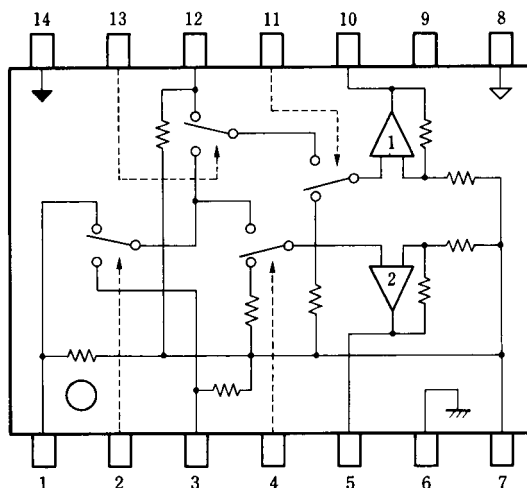

PIN FUNCTION

1. Vin3	8. V ⁺
2. SW1	9. N.C.
3. Vin2	10. Vout1
4. MUTE2	11. MUTE1
5. Vout2	12. Vin1
6. GND2	13. SW2
7. GND1	14. V ⁻

■ PACKAGE OUTLINE

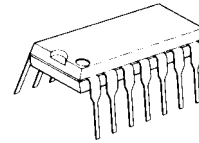

NJM2279D

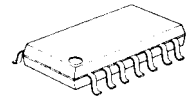

NJM2279M

NJM2279

■ ABSOLUTE MAXIMUM RATINGS

($T_a = 25^\circ\text{C}$)

PARAMETER	SYMBOL	RATINGS	UNIT
Supply Voltage	V^+ / V	± 7.5	V
Power Dissipation	P_D	(DIP14) 700 (DMP14) 300	mW mW
Operating Temperature Range	T_{opr}	-20 to +75	$^\circ\text{C}$
Storage Temperature Range	T_{stg}	-40 to +125	$^\circ\text{C}$

■ ELECTRICAL CHARACTERISTICS

($V^+ / V = \pm 5\text{V}$, $R_L = 150\Omega$, $T_a = 25^\circ\text{C}$)

PARAMETER	SYMBOL	TEST CONDITION	MIN.	TYP.	MAX.	UNIT
Operating Current	I_{CC}	No signal	10.0	17.3	24.6	mA
	I_{EE}	No signal	-24.6	-17.3	-10.0	mA
Voltage Gain	G_V	$V_{IN} = 100\text{kHz} / 1.0V_{P-P}$	6.0	6.3	6.8	dB
Frequency Characteristic	G_f	5MHz / 100kHz, 1.0V _{P-P}	-1.0	0.0	+1.0	dB
Differential Gain	DG	$V_{IN} = 1.0V_{P-P}$, Stair wave	-	0.2	-	%
Differential Phase	DP	$V_{IN} = 1.0V_{P-P}$, Stair wave	-	0.2	-	deg
Offset output Voltage 1	V_{OS1}	$V_{in2} - V_{in3}$: no signal	-40	0	+40	mV
Offset output Voltage 2	V_{OS2}	$V_{in1} - V_{in2} / V_{in3}$: no signal	-60	0	+60	mV
Input / Output Crosstalk	CT	$V_{IN} = 4.43\text{MHz} / 1.0V_{P-P}$, V_O / V_{IN}	-	-70	-	dB
MUTE Crosstalk	CT_M	$V_{IN} = 4.43\text{MHz} / 1.0V_{P-P}$, V_O / V_{IN}	-	-60	-	dB
Switch Change Voltage	V_{CH}		2.5	-	V^+	V
	V_{CL}		0.0	-	1.0	V
Total Harmonic Distortion	THD	$V_{IN} = 1\text{kHz} 1.25V_{P-P}$	-	0.1	-	%
Input Impedance	R_{in}		-	20	-	k Ω

■ CONTROL SIGNAL-OUTPUT SIGNAL

($L = V_{CL}$, $H = V_{CH}$, $X = L$ or H)

CONTROL SIGNAL				OUTPUT	
SW1 (2 pin)	SW2 (13 pin)	MUTE 1 (11 pin)	MUTE 2 (4 pin)	Vout 1 (10 pin)	Vout 2 (5 pin)
X	X	L	L	GND	GND
X	X	L	H	GND	OUT PUT
X	X	H	L	OUT PUT	GND
L	L	H	H	V_{IN1}	V_{IN2}
L	H	H	H	V_{IN2}	V_{IN2}
H	L	H	H	V_{IN1}	V_{IN3}
H	H	H	H	V_{IN3}	V_{IN3}

■ TERMINAL FUNCTION

PIN No.	PIN NAME	INSIDE EQUIVALENT CIRCUIT	NOTE
1 3 12	V _{IN3} V _{IN2} V _{IN1}		Video signal input terminal The bias is done with 20kΩ by the voltage of the terminal GND1. 1Vp-p input (0.0V = GND1)
7	GND1		GND terminal When a single power supply is used, the bias is done to 1/2V+.
2 13	SW1 SW2		Switch control terminal for input signal selection (0.0V = GND2, Uncontrolled)
4 11	MUTE2 MUTE1		Mute control terminal The output is GND1 voltage at the mute. (0.0V = GND2, Uncontrolled)
6	GND2	GND terminal Please connect it with GND regardless of dual power supplies or single power supplies.	
5 10	V _{out2} V _{out1}		Video signal input terminal The output signal level becomes 1VP-P at 75Ω terminal.
8	V ⁺	-	Power supply terminal
14	V	-	Power supply terminal When a single power supply is used, it becomes GND.

NJM2279

TEST CIRCUIT

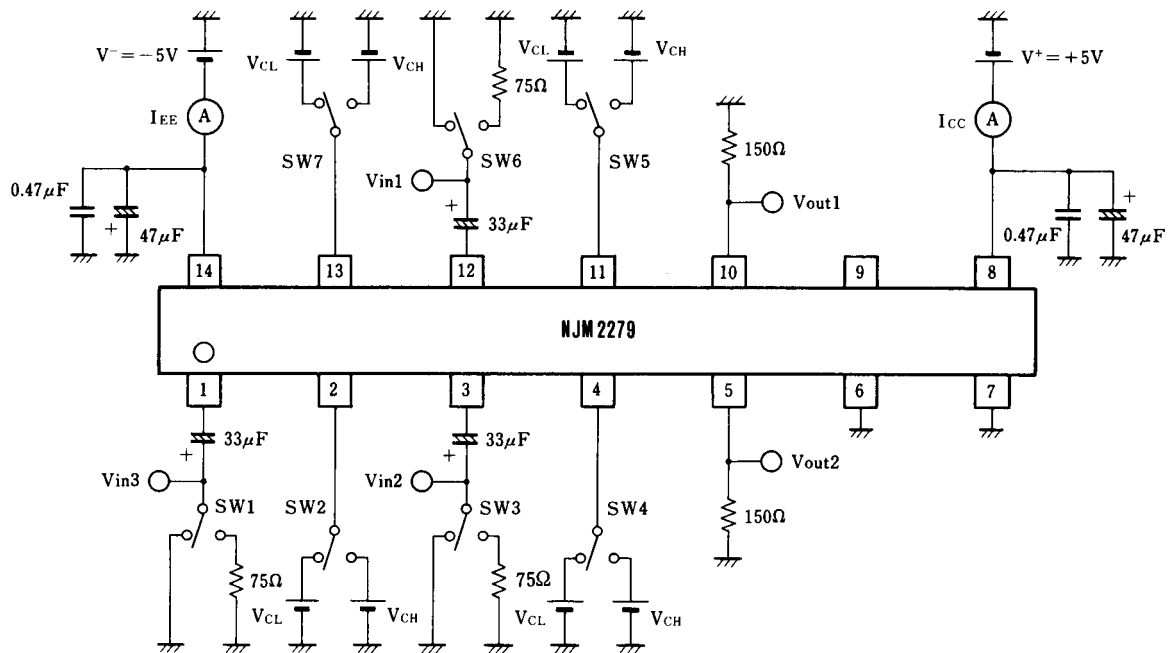

PARAMETER	SYMBOL	UNIT	INPUT TERMINAL	TEST TERMINAL	TEST CONDITION
Operating Current	I_{CC}	mA	-	8 pin	V_{in1} to 3 = 0V, SW1/2·MUTE1/2 = V_{CL}
	I_{EE}	mA	-	14 pin	V_{in1} to 3 = 0V, SW1/2·MUTE1/2 = V_{CL}
Voltage Gain	G_V	dB	1, 3, 12 pin	5, 10 pin	MUTE1/2 = V_{CL}
Frequency Characteristic	G_f	dB	1, 3, 12 pin	5, 10 pin	MUTE1/2 = V_{CL}
Differential Gain	DG	%	1, 3, 12 pin	5, 10 pin	MUTE1/2 = V_{CL}
Differential Phase	DP	deg	1, 3, 12 pin	5, 10 pin	MUTE1/2 = V_{CL}
Offset output Voltage 1	V_{OS1}	mV	1, 3, 12 pin	5, 10 pin	V_{in1} to 3 = 0V
Offset output Voltage 2	V_{OS2}	mV	-	5, 10 pin	V_{in1} to 3 = 0V
Input / Output Crosstalk	CT	dB	-	5, 10 pin	MUTE1/2 = V_{CL}
MUTE Crosstalk	CT_M	dB	1, 3, 12 pin	5, 10 pin	MUTE1/2 = V_{CL}
Switch Change Voltage	V_{CH}	V	1, 3, 12 pin	5, 10 pin	
	V_{CL}	V	-	-	
Total Harmonic Distortion	THD	%	1, 3, 12 pin	5, 10 pin	

APPLICATION CIRCUIT (Dual Power Supply)

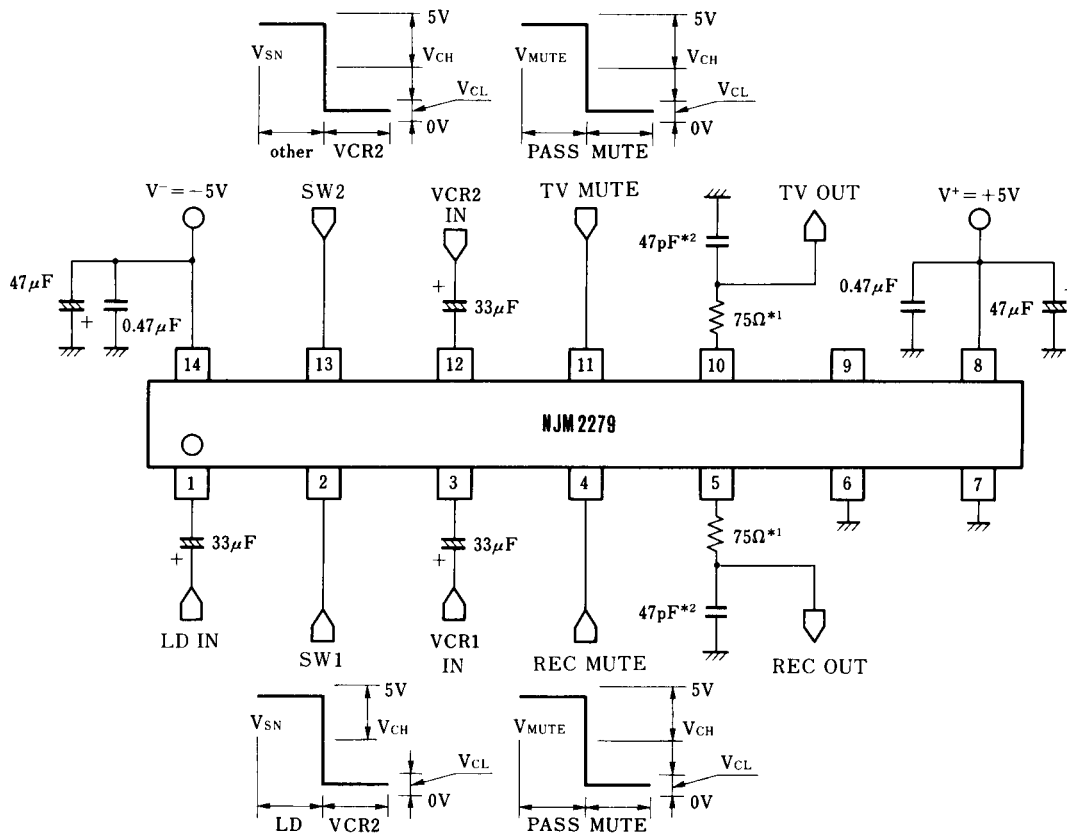

(Note) Terminal connection at single power supply

7pin : 1/2V+ bias

14Pin : GND

■ TYPICAL CHARACTERISTICS

Operating Current vs. Temperature

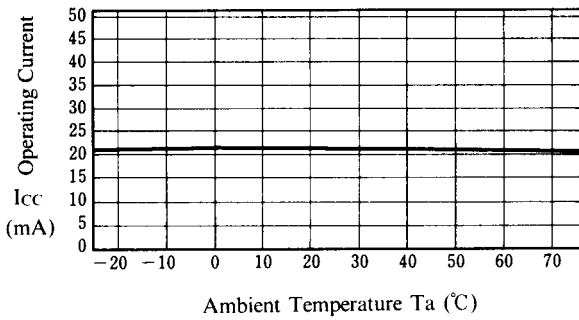

Voltage Gain vs. Temperature

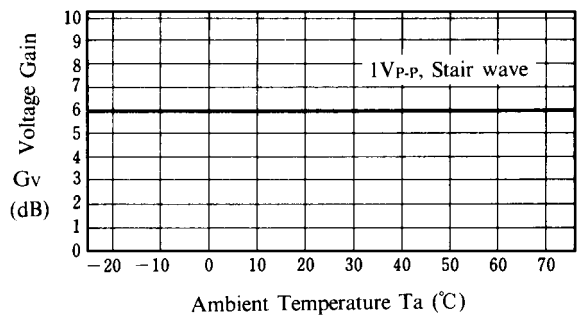

Differential Gain vs. Temperature

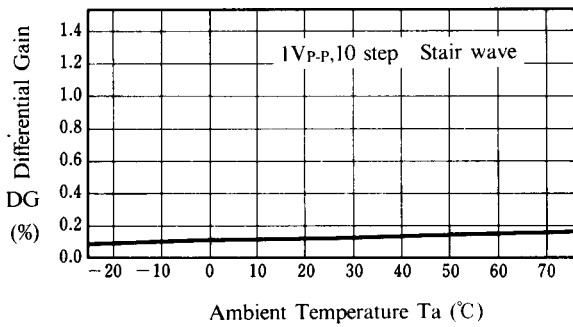

Differential Phase vs. Temperature

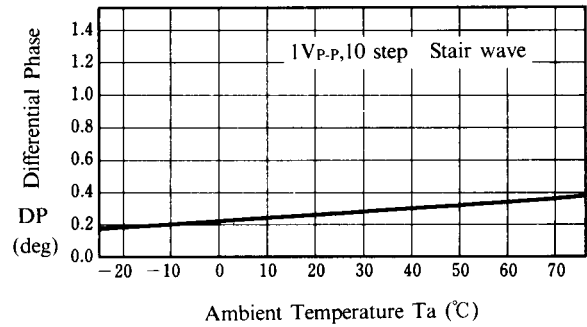

Crosstalk 1 vs. Temperature

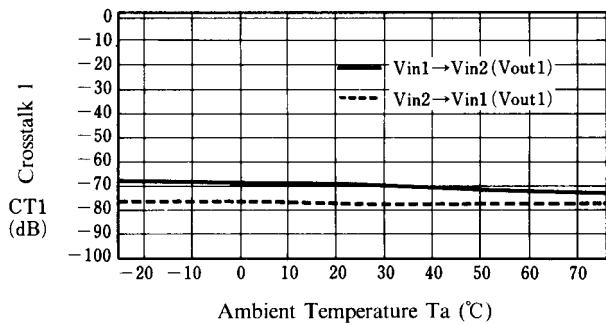

Crosstalk 2 vs. Temperature

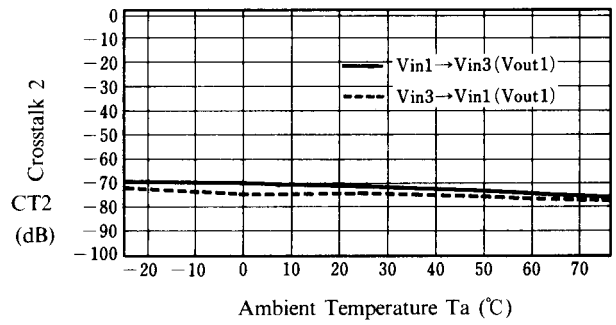

■ TYPICAL CHARACTERISTICS

Crosstalk 3 vs. Temperature

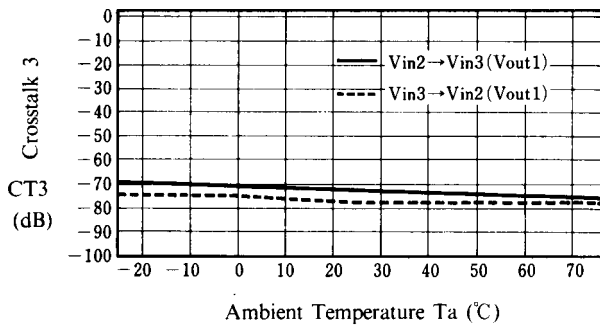

Crosstalk 4 vs. Temperature

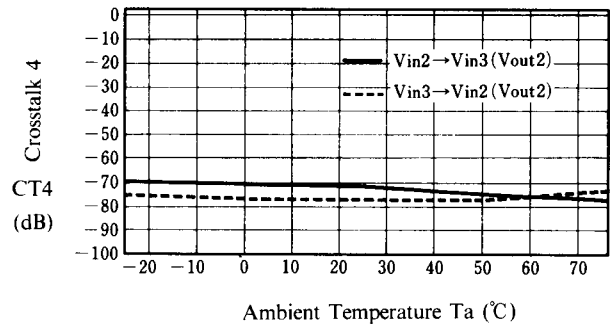

MUTE Crosstalk vs. Temperature

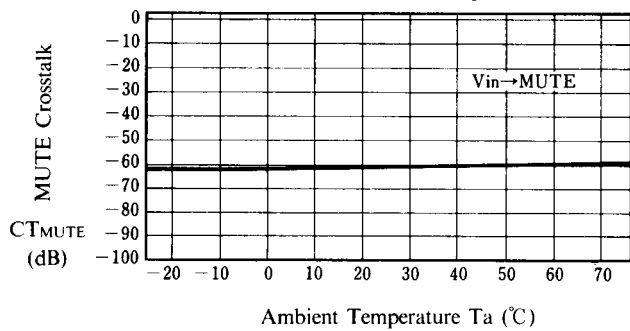

MUTE offset Voltage vs. Temperature

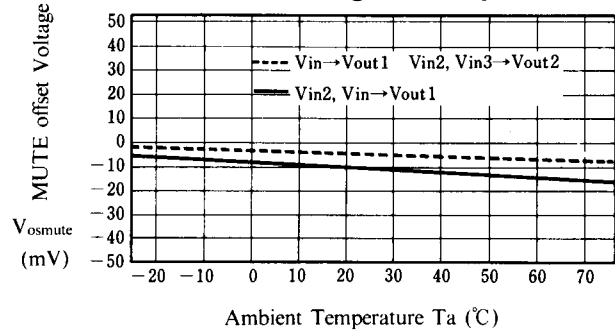

Channel offset Voltage vs. Temperature

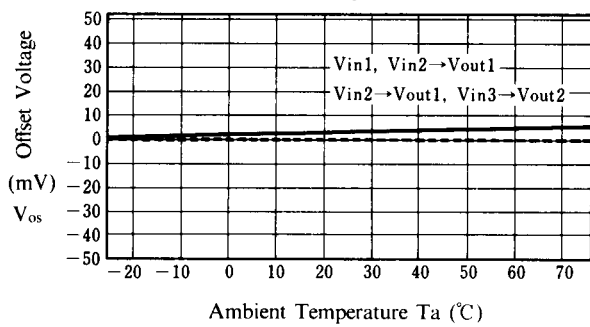

Total Harmonic Distortion vs. Temperature

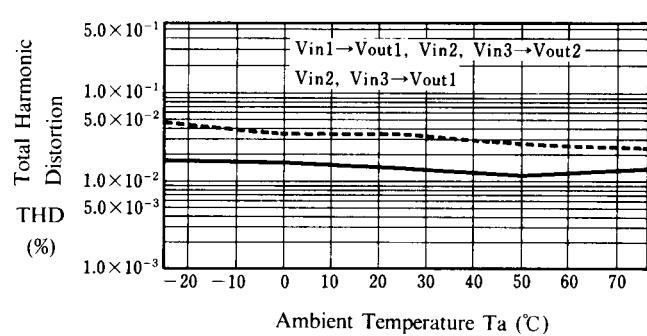

■ TYPICAL CHARACTERISTICS

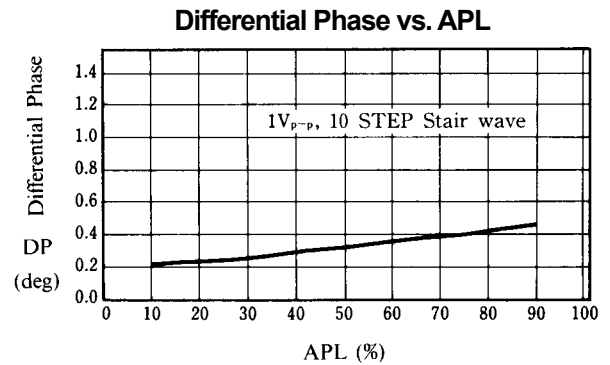
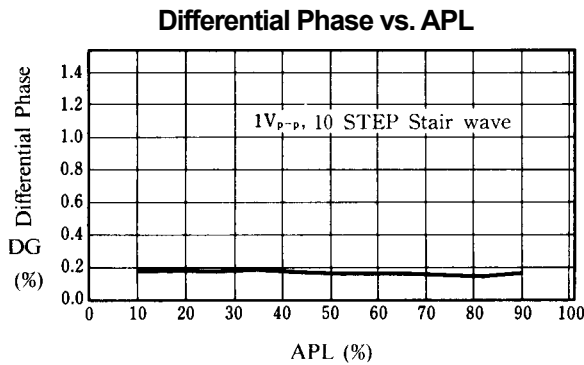
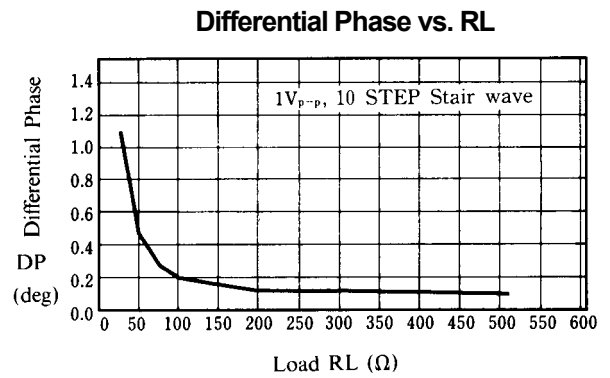
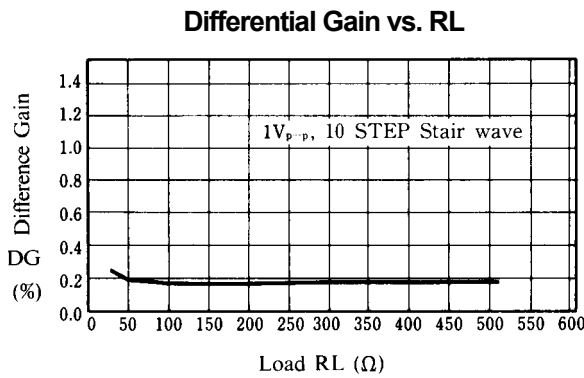
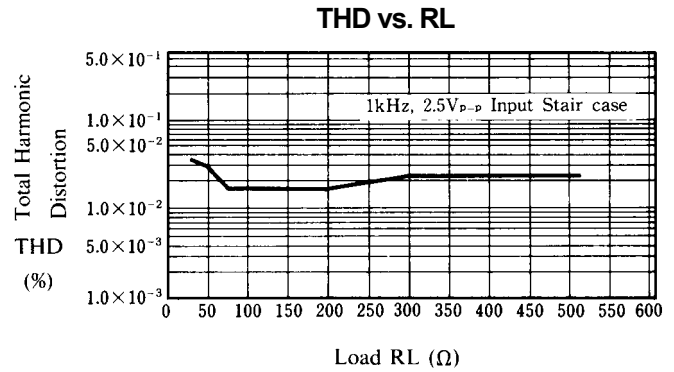
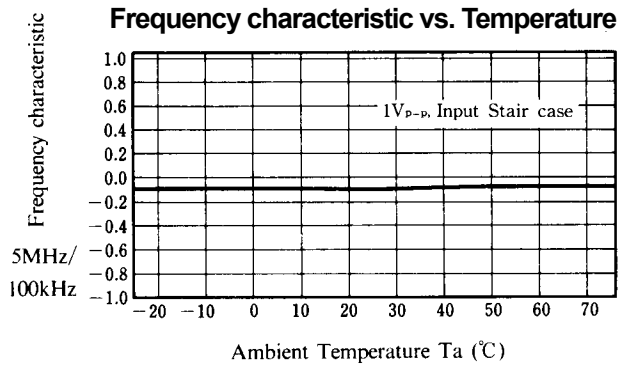

■ TYPICAL CHARACTERISTICS

Operating Current vs. Operating Voltage

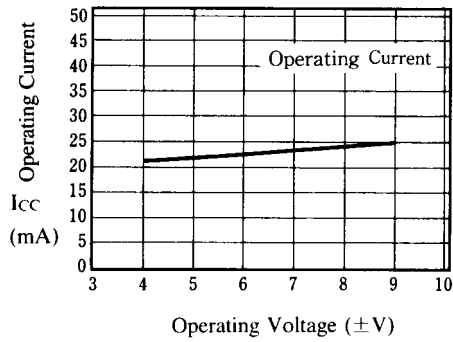

THD vs. Operating Voltage

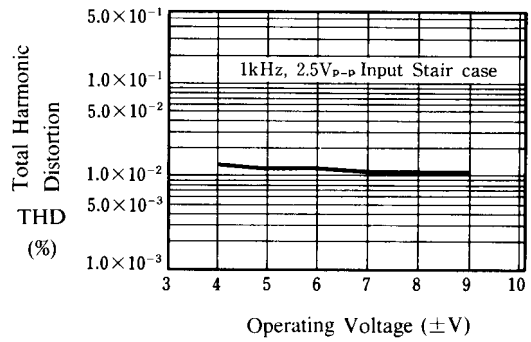

Different Gain vs. Operating Voltage

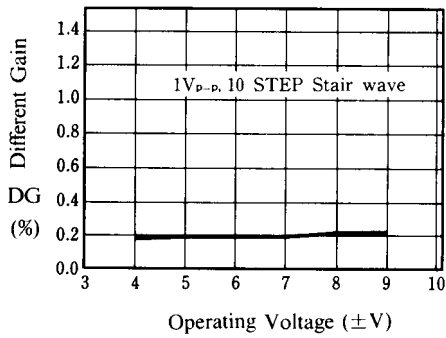

Differential Phase vs. Operating Voltage

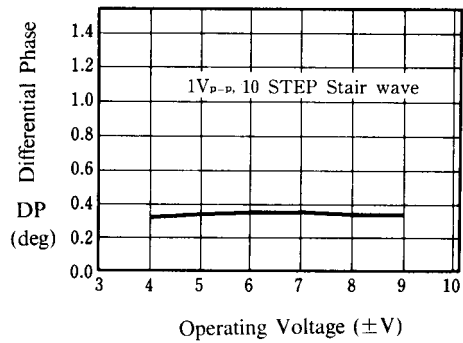

Voltage Gain vs. Frequency

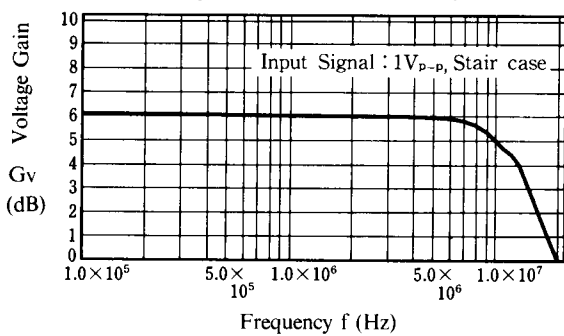

Switching Voltage vs. Operating Voltage

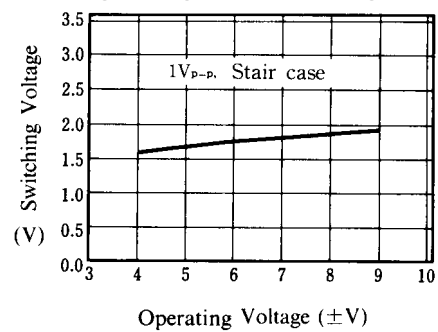

■ TYPICAL CHARACTERISTICS

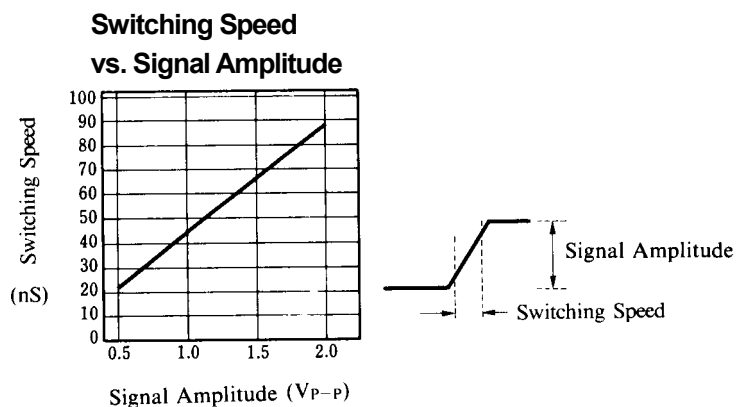

[CAUTION]

The specifications on this databook are only given for information, without any guarantee as regards either mistakes or omissions. The application circuits in this databook are described only to show representative usages of the product and not intended for the guarantee or permission of any right including the industrial rights.