



UCSP, 1.8V, Nanopower, Beyond-the-Rails Comparators With/Without Reference

General Description

The MAX9025–MAX9028 nanopower comparators in space-saving chip-scale (UCSP™) packages feature Beyond-the-Rails™ inputs and are guaranteed to operate down to +1.8V. The MAX9025/MAX9026 feature an on-board 1.236V ±1% reference and draw an ultra-low supply current of only 1µA, while the MAX9027/MAX9028 (without reference) require just 0.6µA of supply current. These features make the MAX9025–MAX9028 family of comparators ideal for all 2-cell battery-monitoring/management applications.

The unique design of the output stage limits supply-current surges while switching, virtually eliminating the supply glitches typical of many other comparators. This design also minimizes overall power consumption under dynamic conditions. The MAX9025/MAX9027 have a push-pull output stage that sinks and sources current. Large internal-output drivers allow rail-to-rail output swing with loads up to 5mA. The MAX9026/MAX9028 have an open-drain output stage that makes them suitable for mixed-voltage system design. All devices are available in the miniature 6-bump UCSP packages.

Refer to the MAX9117 data sheet for similar comparators in 5-pin SC70 packages and the MAX9017 data sheet for similar dual comparators in 8-pin SOT23 packages.

Applications

2-Cell Battery Monitoring/Management
Ultra-Low-Power Systems
Mobile Communications
Notebooks and PDAs
Sensing at Ground or Supply Line
Telemetry and Remote Systems
Medical Instruments

Selector Guide

PART	INTERNAL REFERENCE	OUTPUT TYPE	SUPPLY CURRENT (µA)
MAX9025	Yes	Push-Pull	1.0
MAX9026	Yes	Open-Drain	1.0
MAX9027	No	Push-Pull	0.6
MAX9028	No	Open-Drain	0.6

Typical Application Circuit appears at end of data sheet.

Beyond-the-Rails and UCSP are trademarks of Maxim Integrated Products, Inc.

Features

- ◆ Space-Saving UCSP Package (1mm x 1.52mm)
- ◆ Ultra-Low Supply Current
0.6µA (MAX9027/MAX9028)
1µA with Reference (MAX9025/MAX9026)
- ◆ Guaranteed to Operate Down to +1.8V
- ◆ Internal 1.236V ±1% Reference (MAX9025/MAX9026)
- ◆ Input Voltage Range Extends 200mV Beyond-the-Rails
- ◆ CMOS Push-Pull Output with ±5mA Drive Capability (MAX9025/MAX9027)
- ◆ Open-Drain Output Versions Available (MAX9026/MAX9028)
- ◆ Crowbar-Current-Free Switching
- ◆ Internal Hysteresis for Clean Switching
- ◆ No Phase Reversal for Overdriven Inputs

Ordering Information

PART	TEMP RANGE	BUMP-PACKAGE	TOP MARK
MAX9025EBT-T	-40°C to +85°C	6 UCSP-6	ADB
MAX9026EBT-T	-40°C to +85°C	6 UCSP-6	ADC
MAX9027EBT-T	-40°C to +85°C	6 UCSP-6	ADD
MAX9028EBT-T	-40°C to +85°C	6 UCSP-6	ADE

Pin Configurations

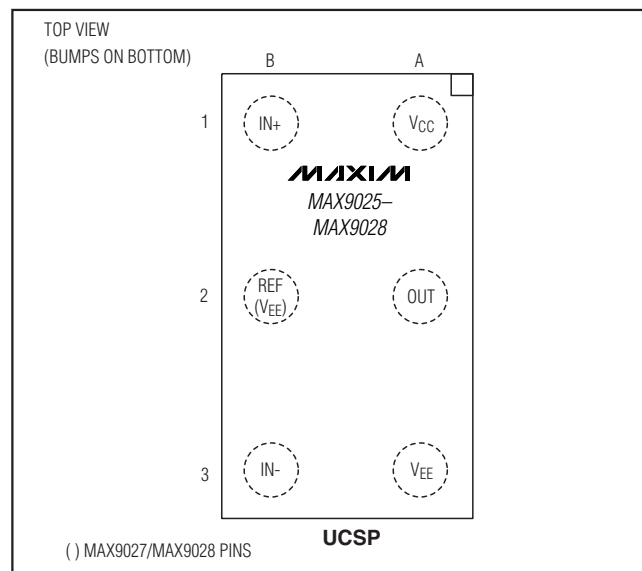

MAX9025-MAX9028



Maxim Integrated Products 1

For pricing, delivery, and ordering information, please contact Maxim/Dallas Direct! at 1-888-629-4642, or visit Maxim's website at www.maxim-ic.com.

UCSP, 1.8V, Nanopower, Beyond-the-Rails Comparators With/Without Reference

ABSOLUTE MAXIMUM RATINGS

Supply Voltage (V_{CC} to V_{EE}).....	+6V	Output Short-Circuit Duration	10s
Voltage Inputs (IN+, IN-, REF)	($V_{EE} - 0.3V$) to ($V_{CC} + 0.3V$)	Continuous Power Dissipation ($T_A = +70^\circ C$).....	6-Bump UCSP (derate 3.9mW/ $^\circ C$ above $+70^\circ C$).....
Output Voltage			308mW
MAX9025/MAX9027	($V_{EE} - 0.3V$) to ($V_{CC} + 0.3V$)	Operating Temperature Range	-40 $^\circ C$ to +85 $^\circ C$
MAX9026/MAX9028	($V_{EE} - 0.3V$) to +6V	Junction Temperature	+150 $^\circ C$
Current into Input Pins20mA	Storage Temperature Range	-65 $^\circ C$ to +150 $^\circ C$
Output Current.....	$\pm 50mA$	Bump Temperature (soldering) Reflow.....	+235 $^\circ C$

Stresses beyond those listed under "Absolute Maximum Ratings" may cause permanent damage to the device. These are stress ratings only, and functional operation of the device at these or any other conditions beyond those indicated in the operational sections of the specifications is not implied. Exposure to absolute maximum rating conditions for extended periods may affect device reliability.

ELECTRICAL CHARACTERISTICS—MAX9025/MAX9026 (WITH REF)

($V_{CC} = +5V$, $V_{EE} = 0V$, $V_{IN+} = V_{REF}$, $T_A = -40^\circ C$ to $+85^\circ C$, unless otherwise noted. Typical values are at $T_A = +25^\circ C$.) (Note 1)

PARAMETER	SYMBOL	CONDITIONS		MIN	TYP	MAX	UNITS
Supply Voltage Range	V_{CC}	Inferred from the PSRR test		1.8		5.5	V
Supply Current	I_{CC}	$V_{CC} = 1.8V$			0.8	1.5	μA
		$V_{CC} = 5V$	$T_A = +25^\circ C$		1.0	1.7	
			$T_A = T_{MIN}$ to T_{MAX}			2.2	
IN+ Voltage Range	V_{IN+}	Inferred from output swing test		$V_{EE} - 0.2$		$V_{CC} + 0.2$	V
Input Offset Voltage	V_{OS}	(Note 2)	$T_A = +25^\circ C$		0.3	5	mV
			$T_A = T_{MIN}$ to T_{MAX}			10	
Input-Referred Hysteresis	V_{HB}	(Note 3)			4		mV
Input Bias Current	I_B	$T_A = +25^\circ C$			0.15	1	nA
		$T_A = T_{MIN}$ to T_{MAX}				2	
Power-Supply Rejection Ratio	PSRR	$V_{CC} = 1.8V$ to $5.5V$			0.1	1	mV/V
Output Voltage Swing High	$V_{CC} - V_{OH}$	MAX9025, $V_{CC} = 5V$, $I_{SOURCE} = 6mA$	$T_A = +25^\circ C$		250	350	mV
			$T_A = T_{MIN}$ to T_{MAX}			450	
		MAX9025, $V_{CC} = 1.8V$, $I_{SOURCE} = 1mA$	$T_A = +25^\circ C$		56	200	
			$T_A = T_{MIN}$ to T_{MAX}			300	
Output Voltage Swing Low	V_{OL}	$V_{CC} = 5V$, $I_{SINK} = 6mA$	$T_A = +25^\circ C$		250	350	mV
			$T_A = T_{MIN}$ to T_{MAX}			450	
		$V_{CC} = 1.8V$, $I_{SINK} = 1mA$	$T_A = +25^\circ C$		57	200	
			$T_A = T_{MIN}$ to T_{MAX}			300	
Output Leakage Current	I_{LEAK}	MAX9026 only, $V_O = 5.5V$			0.001	1	μA
Output Short-Circuit Current	I_{SC}	Sourcing, $V_O = V_{EE}$	$V_{CC} = 5V$		35		mA
			$V_{CC} = 1.8V$		3		
		Sinking, $V_O = V_{CC}$	$V_{CC} = 5V$		33		
			$V_{CC} = 1.8V$		3		
High-to-Low Propagation Delay (Note 4)	t_{PD-}	$V_{CC} = 1.8V$			7		μs
		$V_{CC} = 5V$			6		

UCSP, 1.8V, Nanopower, Beyond-the-Rails Comparators With/Without Reference

MAX9025-MAX9028

ELECTRICAL CHARACTERISTICS—MAX9025/MAX9026 (WITH REF) (continued)

($V_{CC} = +5V$, $V_{EE} = 0V$, $V_{IN+} = V_{REF}$, $T_A = -40^{\circ}C$ to $+85^{\circ}C$, unless otherwise noted. Typical values are at $T_A = +25^{\circ}C$.) (Note 1)

PARAMETER	SYMBOL	CONDITIONS		MIN	TYP	MAX	UNITS
Low-to-High Propagation Delay (Note 4)	t_{PD+}	MAX9025 only	$V_{CC} = 1.8V$		11		μs
			$V_{CC} = 5V$		28		
		MAX9026 only, $R_{PULLUP} = 100k\Omega$	$V_{CC} = 1.8V$		12		
			$V_{CC} = 5V$		31		
Rise Time	t_{RISE}	MAX9025 only, $C_L = 15pF$			1.6		μs
Fall Time	t_{FALL}	$C_L = 15pF$			0.2		μs
Power-Up Time	t_{ON}				1.2		ms
Reference Voltage	V_{REF}	$T_A = +25^{\circ}C$		1.224	1.236	1.248	V
		$T_A = T_{MIN}$ to T_{MAX}		1.205		1.267	
Reference Voltage Temperature Coefficient	TC_{REF}				40		ppm/ $^{\circ}C$
Reference Output Voltage Noise	E_N	$C_{REF} = 1nF$	$BW = 10Hz$ to $100kHz$		29		μV_{RMS}
			$BW = 10Hz$ to $6kHz$		60		
Reference Line Regulation	$\frac{\Delta V_{REF}}{\Delta V_{CC}}$	$V_{CC} = 1.8V$ to $5.5V$			0.5		mV/V
Reference Load Regulation	$\frac{\Delta V_{REF}}{\Delta I_{OUT}}$	$\Delta I_{OUT} = 0nA$ to $100nA$			0.03		mV/ nA

ELECTRICAL CHARACTERISTICS—MAX9027/MAX9028 (WITHOUT REF)

($V_{CC} = +5V$, $V_{EE} = 0V$, $V_{CM} = 0V$, $T_A = -40^{\circ}C$ to $+85^{\circ}C$, unless otherwise noted. Typical values are at $T_A = +25^{\circ}C$.) (Note 1)

PARAMETER	SYMBOL	CONDITIONS		MIN	TYP	MAX	UNITS
Supply Voltage Range	V_{CC}	Inferred from the PSRR test		1.8		5.5	V
Supply Current	I_{CC}	$V_{CC} = 1.8V$			0.45	0.75	μA
		$V_{CC} = 5V$	$T_A = +25^{\circ}C$		0.6	1.0	
			$T_A = T_{MIN}$ to T_{MAX}			1.25	
Input Common-Mode Voltage Range	V_{CM}	Inferred from the CMRR test		$V_{EE} - 0.2$		$V_{CC} + 0.2$	V
Input Offset Voltage	V_{OS}	$-0.2V \leq V_{CM} \leq (V_{CC} + 0.2V)$ (Note 2)	$T_A = +25^{\circ}C$		0.3	5	mV
			$T_A = T_{MIN}$ to T_{MAX}			10	
Input-Referred Hysteresis	V_{HB}	$-0.2V \leq V_{CM} \leq (V_{CC} + 0.2V)$ (Note 3)			4		mV
Input Bias Current	I_B	$T_A = +25^{\circ}C$			0.15	1	nA
		$T_A = T_{MIN}$ to T_{MAX}				2	
Power-Supply Rejection Ratio	PSRR	$V_{CC} = 1.8V$ to $5.5V$			0.1	1	mV/V
Common-Mode Rejection Ratio	CMRR	$(V_{EE} - 0.2V) \leq V_{CM} \leq (V_{CC} + 0.2V)$			0.5	3	mV/V

UCSP, 1.8V, Nanopower, Beyond-the-Rails Comparators With/Without Reference

ELECTRICAL CHARACTERISTICS—MAX9027/MAX9028 (WITHOUT REF) (continued)

($V_{CC} = +5V$, $V_{EE} = 0V$, $V_{CM} = 0V$, $T_A = -40^{\circ}C$ to $+85^{\circ}C$, unless otherwise noted. Typical values are at $T_A = +25^{\circ}C$.) (Note 1)

PARAMETER	SYMBOL	CONDITIONS	MIN	TYP	MAX	UNITS
Output Voltage Swing High	$V_{CC} - V_{OH}$	MAX9027 only, $V_{CC} = 5V$, $I_{SOURCE} = 5mA$	$T_A = +25^{\circ}C$	191	400	mV
			$T_A = T_{MIN}$ to T_{MAX}		500	
		MAX9028 only, $V_{CC} = 1.8V$, $I_{SOURCE} = 1mA$	$T_A = +25^{\circ}C$	58	200	
			$T_A = T_{MIN}$ to T_{MAX}		300	
Output Voltage Swing Low	V_{OL}	$V_{CC} = 5V$, $I_{SINK} = 5mA$	$T_A = +25^{\circ}C$	191	400	mV
			$T_A = T_{MIN}$ to T_{MAX}		500	
		$V_{CC} = 1.8V$, $I_{SINK} = 1mA$	$T_A = +25^{\circ}C$	56	200	
			$T_A = T_{MIN}$ to T_{MAX}		300	
Output Leakage Current	I_{LEAK}	MAX9028 only, $V_O = 5.5V$		0.001	1	μA
Output Short-Circuit Current	I_{SC}	Sourcing, $V_O = V_{EE}$	$V_{CC} = 5V$	35		mA
			$V_{CC} = 1.8V$	3		
		Sourcing, $V_O = V_{CC}$	$V_{CC} = 5V$	33		
			$V_{CC} = 1.8V$	3		
High-to-Low Propagation Delay (Note 4)	t_{PD-}		$V_{CC} = 1.8V$	16		μs
			$V_{CC} = 5V$	14		
Low-to-High Propagation Delay (Note 4)	t_{PD+}	MAX9027 only	$V_{CC} = 1.8V$	15		μs
			$V_{CC} = 5V$	40		
		MAX9028 only	$V_{CC} = 1.8V$, $R_{PULLUP} = 100k\Omega$	16		
			$V_{CC} = 5V$, $R_{PULLUP} = 100k\Omega$	45		
Rise Time	t_{RISE}	MAX9027 only, $C_L = 15pF$		1.6		μs
Fall Time	t_{FALL}	$C_L = 15pF$		0.2		μs
Power-Up Time	t_{ON}			1.2		ms

Note 1: All specifications are 100% tested at $T_A = +25^{\circ}C$. Specification limits over temperature ($T_A = T_{MIN}$ to T_{MAX}) are guaranteed by design, not production tested.

Note 2: V_{OS} is defined as the center of the hysteresis band at the input.

Note 3: The hysteresis-related trip points are defined as the edges of the hysteresis band, measured with respect to the center of the band (i.e., V_{OS}) (Figure 2).

Note 4: Specified with an input overdrive ($V_{OVERDRIVE}$) of 100mV, and load capacitance of $C_L = 15pF$. $V_{OVERDRIVE}$ is defined above and beyond the offset voltage and hysteresis of the comparator input. For the MAX9025/MAX9026, reference voltage error should also be added.

UCSP, 1.8V, Nanopower, Beyond-the-Rails Comparators With/Without Reference

Typical Operating Characteristics

($V_{CC} = +5V$, $V_{EE} = 0V$, $C_L = 15pF$, $V_{OVERDRIVE} = 100mV$, $T_A = +25^\circ C$, unless otherwise noted.)

MAX9025-MAX9028

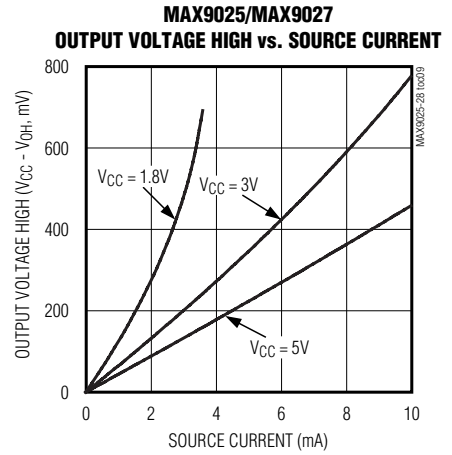
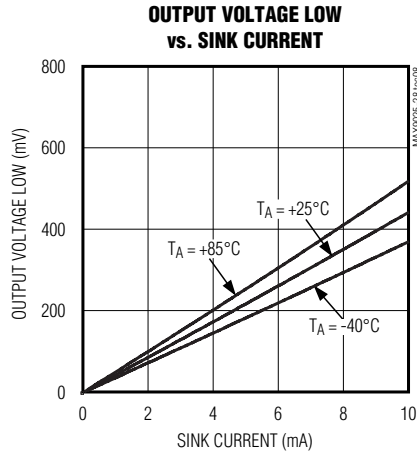
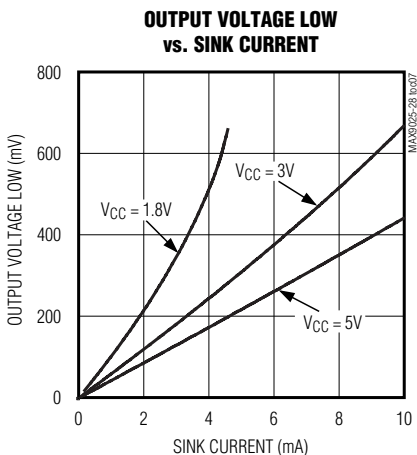
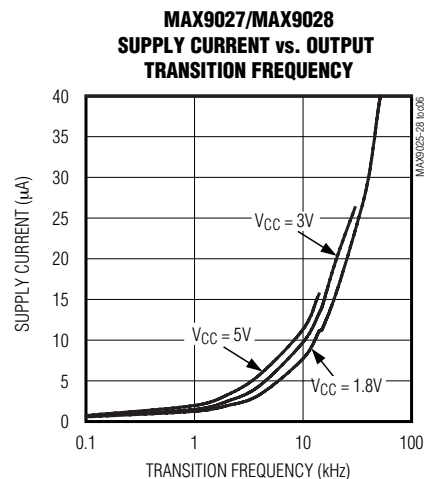
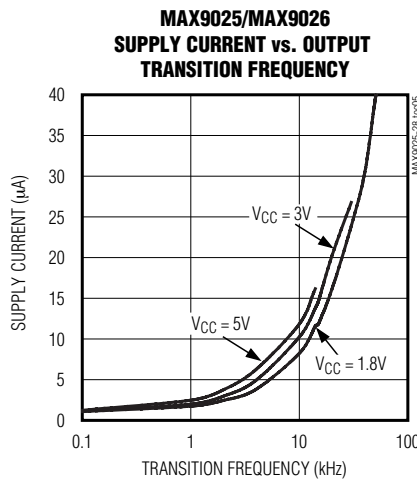
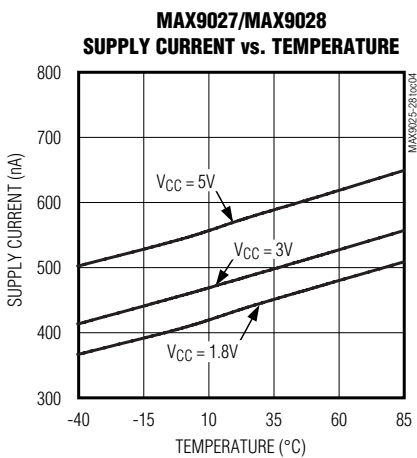
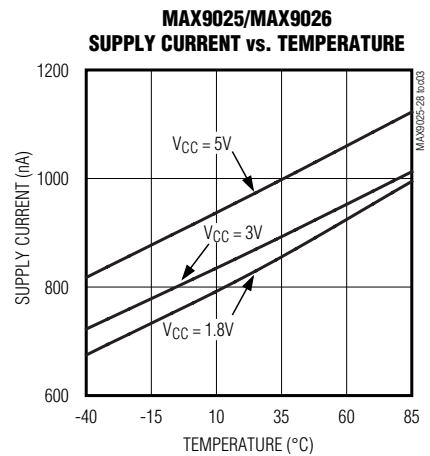
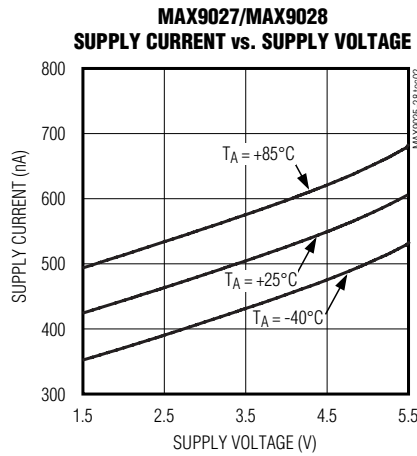
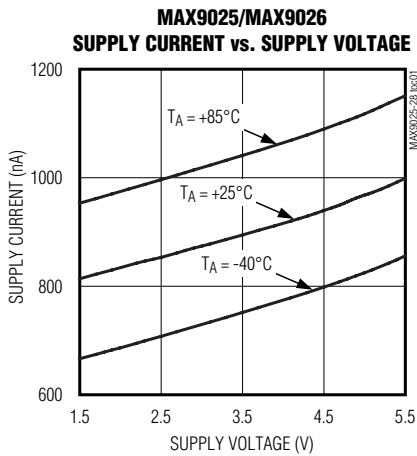

UCSP, 1.8V, Nanopower, Beyond-the-Rails Comparators With/Without Reference

Typical Operating Characteristics (continued)

($V_{CC} = +5V$, $V_{EE} = 0V$, $C_L = 15pF$, $V_{OVERDRIVE} = 100mV$, $T_A = +25^\circ C$, unless otherwise noted.)

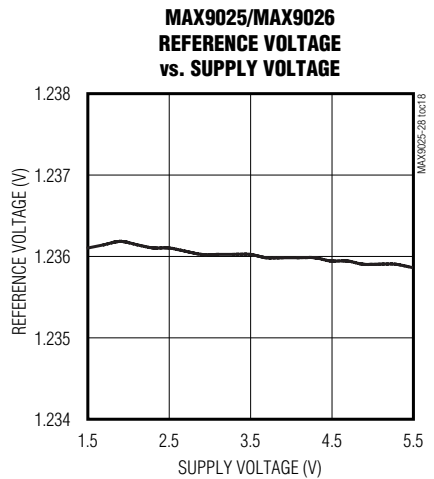
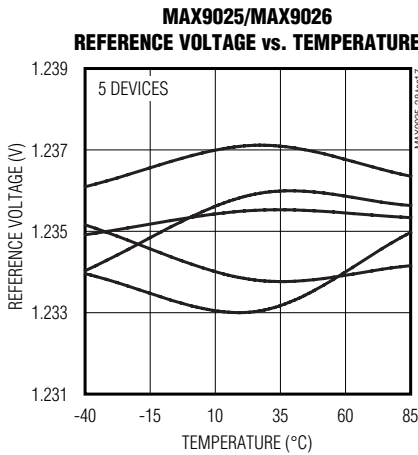
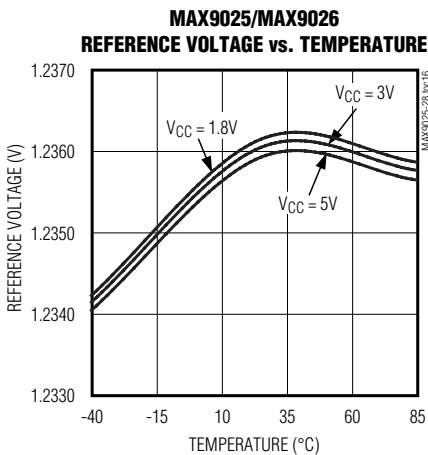
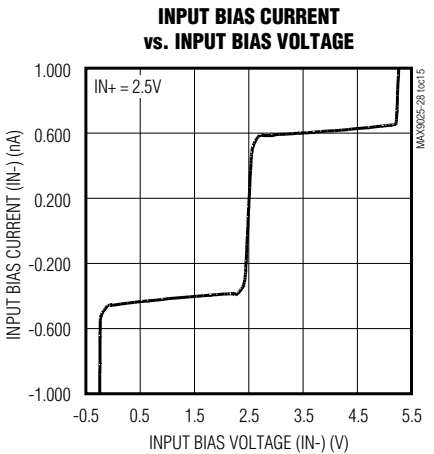
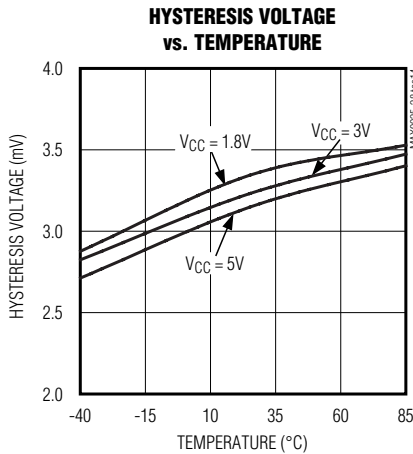
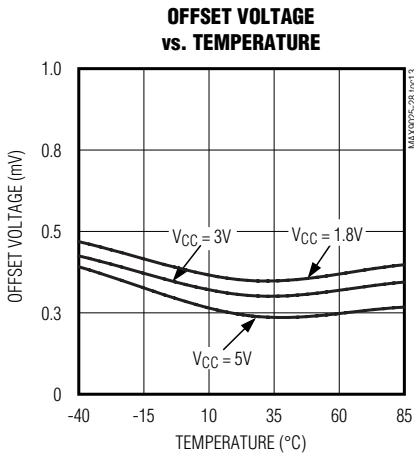
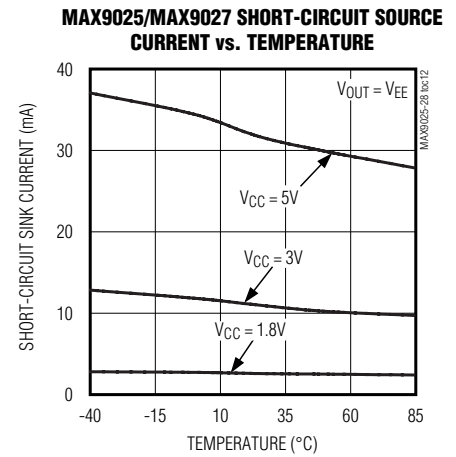
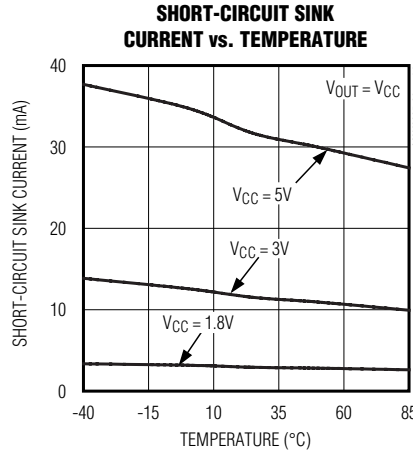
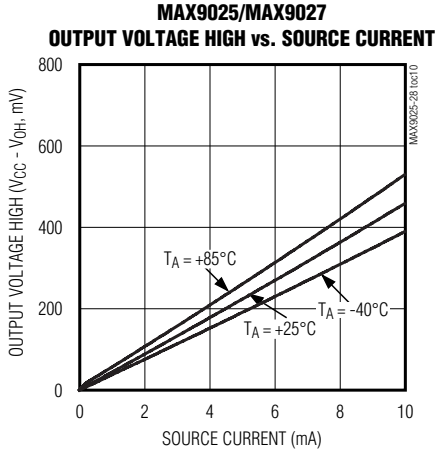

UCSP, 1.8V, Nanopower, Beyond-the-Rails Comparators With/Without Reference

Typical Operating Characteristics (continued)

($V_{CC} = +5V$, $V_{EE} = 0V$, $C_L = 15pF$, $V_{OVERDRIVE} = 100mV$, $T_A = +25^{\circ}C$, unless otherwise noted.)

MAX9025-MAX9028

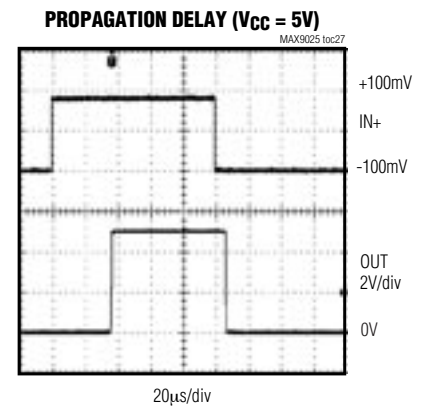
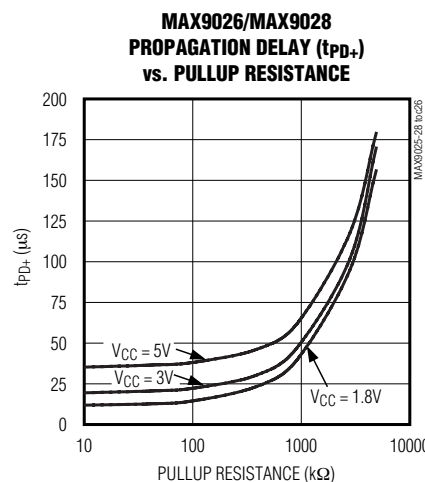
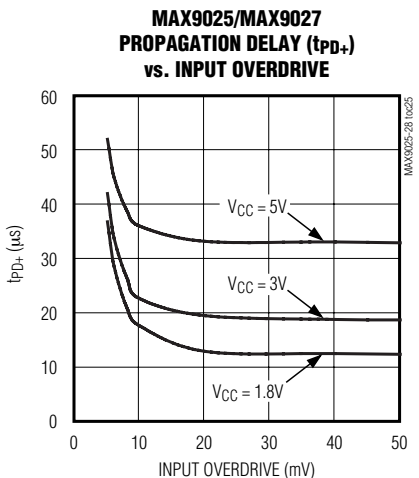
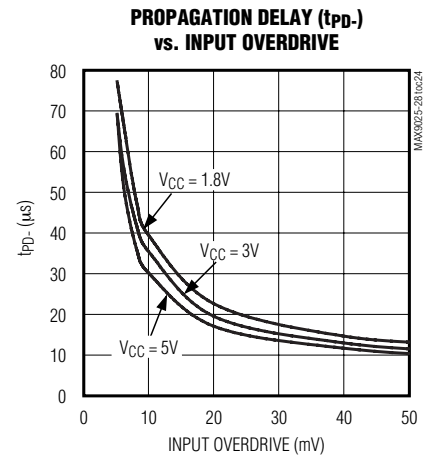
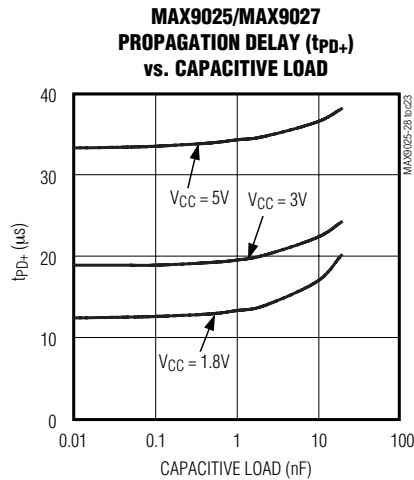
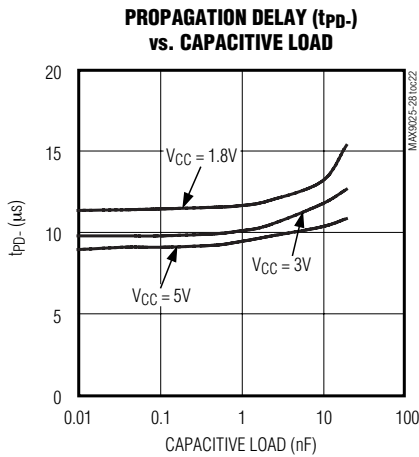
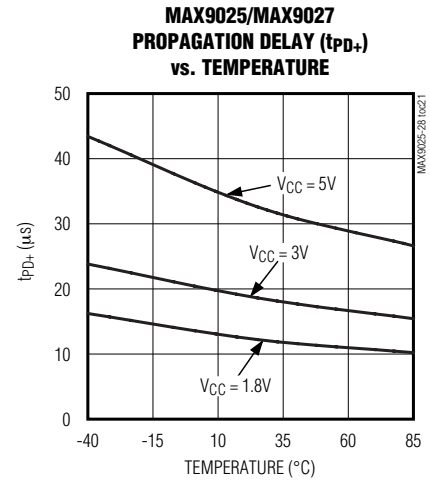
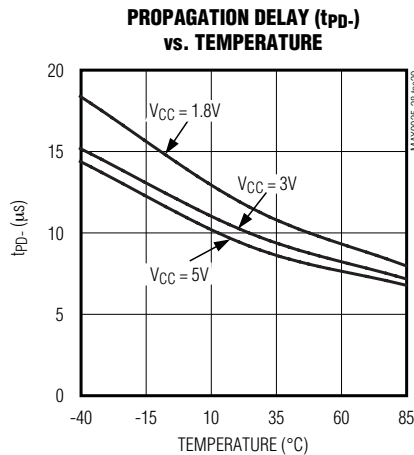
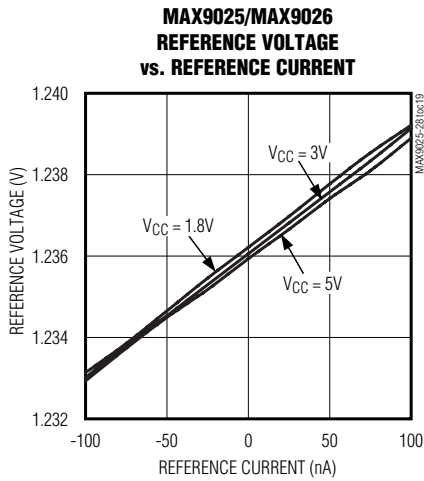

UCSP, 1.8V, Nanopower, Beyond-the-Rails Comparators With/Without Reference

Typical Operating Characteristics (continued)

($V_{CC} = +5V$, $V_{EE} = 0V$, $C_L = 15pF$, $V_{OVERDRIVE} = 100mV$, $T_A = +25^\circ C$, unless otherwise noted.)

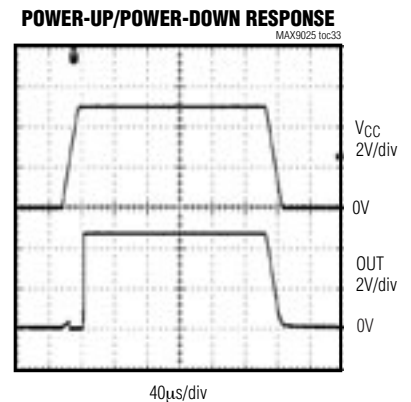
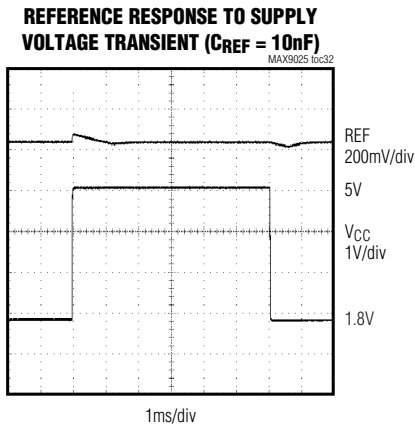
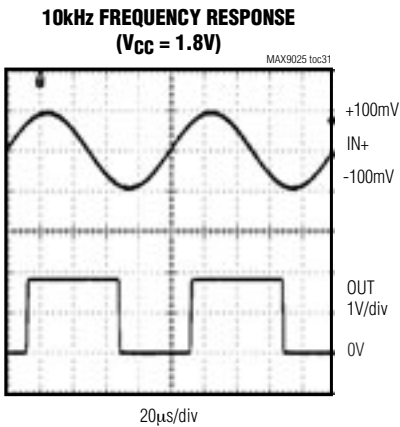
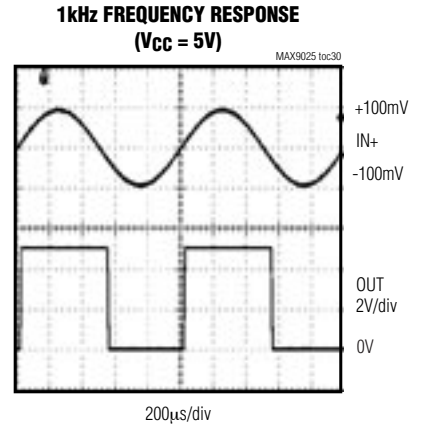
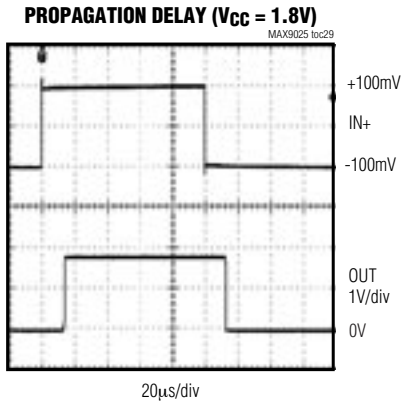
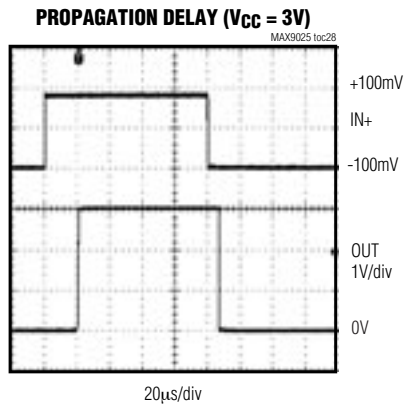

UCSP, 1.8V, Nanopower, Beyond-the-Rails Comparators With/Without Reference

Functional Diagrams

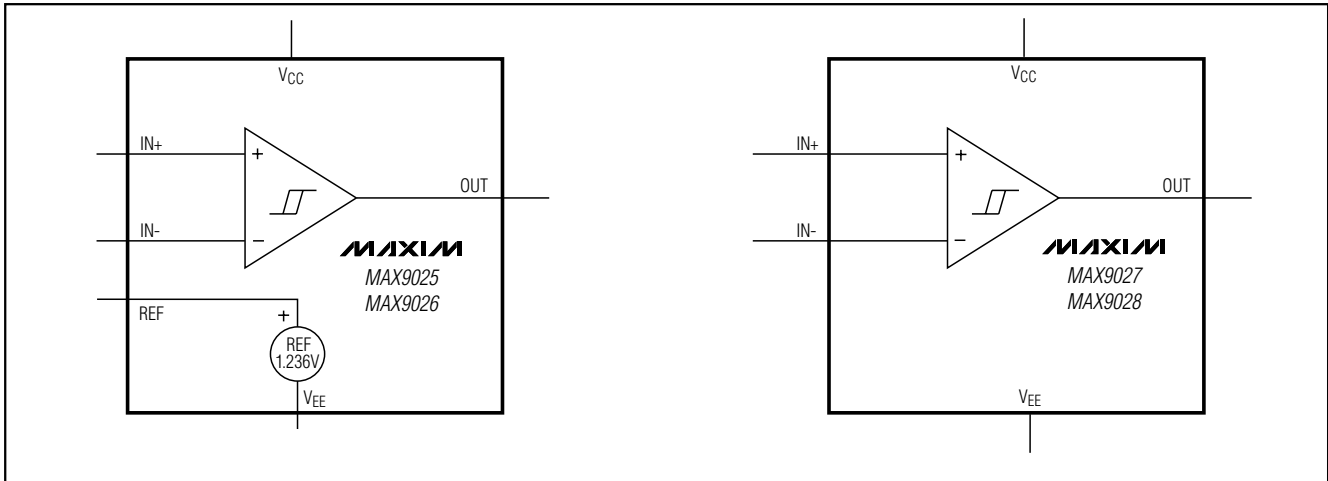

MAX9025-MAX9028

Pin Description

PIN		NAME	FUNCTION
MAX9025/ MAX9026	MAX9027/ MAX9028		
A2	A2	OUT	Comparator Output
A3	A3, B2	VEE	Negative Supply Voltage
B1	B1	IN+	Comparator Noninverting Input
B2	—	REF	1.236V Reference Output
A1	A1	VCC	Positive Supply Voltage
B3	B3	IN-	Comparator Inverting Input

Detailed Description

The MAX9025/MAX9026 feature an on-board 1.236V $\pm 1\%$ reference, yet draw an ultra-low supply current of 1.0 μ A. The MAX9027/MAX9028 (without reference) consume just 0.6 μ A of supply current. All four devices are guaranteed to operate down to +1.8V. Their common-mode input voltage range extends 200mV beyond-the-rails. Internal hysteresis ensures clean output switching, even with slow-moving input signals. Large internal output drivers allow rail-to-rail output swing with up to ± 5 mA loads.

The output stage employs a unique design that minimizes supply-current surges while switching, virtually eliminating the supply glitches typical of many other comparators. The MAX9025/MAX9027 have a push-pull output stage that sinks as well as sources current. The

MAX9026/MAX9028 have an open-drain output stage that can be pulled beyond V_{CC} to a maximum of 5.5V above V_{EE} . These open-drain versions are ideal for implementing wire-OR output logic functions.

Input Stage Circuitry

The input common-mode voltage range extends from $V_{EE} - 0.2$ V to $V_{CC} + 0.2$ V. These comparators operate at any differential input voltage within these limits. Input bias current is typically ± 0.15 nA if the input voltage is between the supply rails. Comparator inputs are protected from overvoltage by internal ESD protection diodes connected to the supply rails. As the input voltage exceeds the supply rails, these ESD protection diodes become forward biased and begin to conduct.

Output Stage Circuitry

The MAX9025-MAX9028 contain a unique break-before-make output stage capable of rail-to-rail operation with up to ± 5 mA loads. Many comparators consume orders of magnitude more current during switching than during steady-state operation. However, with this family of comparators, the supply-current change during an output transition is extremely small. In the *Typical Operating Characteristics*, the Supply Current vs. Output Transition Frequency graphs show the minimal supply-current increase as the output switching frequency approaches 1kHz. This characteristic reduces the need for power-supply filter capacitors to reduce glitches created by comparator switching currents. In battery-powered applications, this characteristic results in a substantial increase in battery life.

UCSP, 1.8V, Nanopower, Beyond-the-Rails Comparators With/Without Reference

Reference (MAX9025/MAX9026)

The MAX9025–MAX9028s' internal +1.236V reference has a typical temperature coefficient of 40ppm/°C over the full -40°C to +85°C temperature range. The reference is a very-low-power bandgap cell, with a typical 35kΩ output impedance. REF can source and sink up to 100nA to external circuitry. For applications needing increased drive, buffer REF with a low input-bias current op amp such as the MAX4162. Most applications require no REF bypass capacitor. For noisy environments or fast VCC transients, connect a 1nF to 10nF ceramic capacitor from REF to GND.

Applications Information

Low-Voltage, Low-Power Operation

The MAX9025–MAX9028 are ideally suited for use with most battery-powered systems. Table 1 lists a variety of battery types, capacities, and approximate operating times for the MAX9025–MAX9028, assuming nominal conditions.

Internal Hysteresis

Many comparators oscillate in the linear region of operation because of noise or undesired parasitic feedback. This tends to occur when the voltage on one input is equal or very close to the voltage on the other input. The MAX9025–MAX9028 have internal 4mV hysteresis to counter parasitic effects and noise.

The hysteresis in a comparator creates two trip points: one for the rising input voltage (V_{THR}) and one for the falling input voltage (V_{THF}) (Figure 2). The difference between the trip points is the hysteresis (V_{HB}). When the comparator's input voltages are equal, the hysteresis effectively causes one comparator input to move

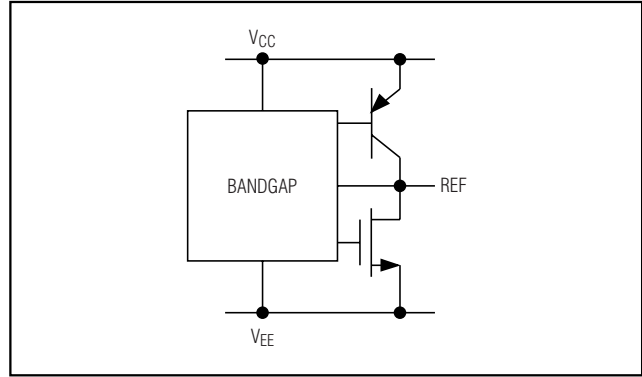

Figure 1. MAX9025/MAX9026 Voltage Reference Output Equivalent Circuit

quickly past the other, thus taking the input out of the region where oscillation occurs. Figure 2 illustrates the case in which IN- has a fixed voltage applied, and IN+ is varied. If the inputs were reversed, the figure would be the same, except with an inverted output.

Adding External Hysteresis

In applications requiring more than the internal 4mV hysteresis of the MAX9025–MAX9028, additional hysteresis can be added with external components. Because the MAX9025–MAX9028 are intended for very low-power systems, care should be taken to minimize power dissipation in the additional circuitry.

Regardless of which approach is taken, the external hysteresis will be V_{CC} dependent. Over the full discharge range of battery-powered systems, the hysteresis can change as much as 40%. This must be considered during design.

Table 1. Battery Applications Using MAX9025–MAX9028

BATTERY TYPE	RECHARGEABLE	V _{FRESH} (V)	V _{END-OF-LIFE} (V)	CAPACITY, AA SIZE (mA-H)	MAX9025/MAX9026 OPERATING TIME (hr)	MAX9027/MAX9028 OPERATING TIME (hr)
Alkaline (2 Cells)	No	3.0	1.8	2000	1.8 x 10 ⁶	2.8 x 10 ⁶
Nickel-Cadmium (2 Cells)	Yes	2.4	1.8	750	680,000	1.07 x 10 ⁶
Lithium-Ion (1 Cell)	Yes	3.5	2.7	1000	0.9 x 10 ⁶	1.4 x 10 ⁶
Nickel-Metal-Hydride (2 Cells)	Yes	2.4	1.8	1000	0.9 x 10 ⁶	1.4 x 10 ⁶

UCSP, 1.8V, Nanopower, Beyond-the-Rails Comparators With/Without Reference

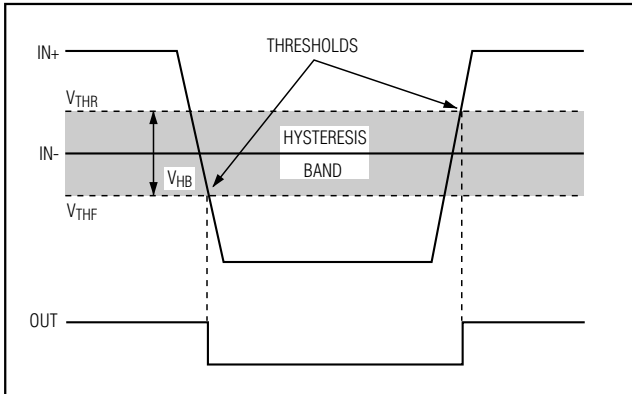

Figure 2. Threshold Hysteresis Band

Simplest Circuit

The simplest circuit for adding external hysteresis is shown in Figure 3. In this example, the hysteresis is defined by:

$$\text{Hysteresis} = \frac{R_S}{R_{FB}} \times V_{CC}$$

where R_S is the source resistance and R_{FB} is the feedback resistance. Because the comparison threshold is $1/2 V_{CC}$, the MAX9027 was chosen for its push-pull output and lack of reference. This provides symmetrical hysteresis around the threshold.

Output Considerations

In most cases, the push-pull outputs of the MAX9025/MAX9027 are best for external hysteresis. The open-drain output of the MAX9026/MAX9028 can be used, but the effect of the feedback network on the actual output high voltage must be considered.

Component Selection

Because the MAX9025–MAX9028 are intended for very low power-supply systems, the highest impedance circuits should be used wherever possible. The offset error due to input-bias current is proportional to the total impedance seen at the input. For example, selecting components for Figure 3, with a target of 50mV hysteresis, a 5V supply, and choosing an R_{FB} of $10M\Omega$ gives R_S as $100k\Omega$. The total impedance seen at $IN+$ is therefore $10M\Omega \parallel 100k\Omega$, or $99k\Omega$. The maximum I_B of the MAX9025–MAX9028 is 2nA; therefore, the error due to source impedance is less than $400\mu V$.

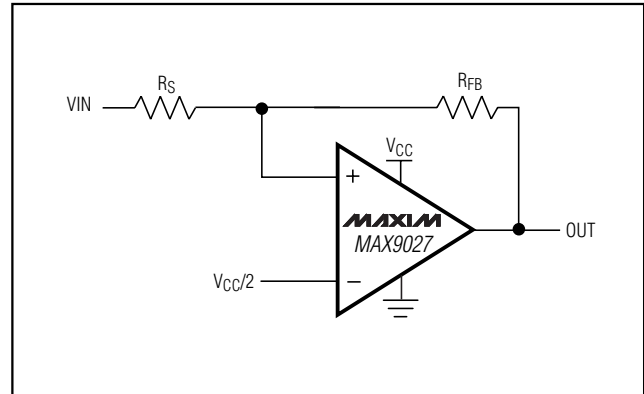

Figure 3. MAX9025/MAX9027 External Hysteresis

Asymmetrical Hysteresis

When the input threshold is not set at $1/2 V_{CC}$, the hysteresis added to the input threshold will not be symmetrical. This is typical of the MAX9025/MAX9026 where the internal reference is usually used as the threshold. If the asymmetry is unacceptable, it can be corrected by adding resistors to the circuit.

Board Layout and Bypassing

Power-supply bypass capacitors are not typically needed, but use 100nF bypass capacitors close to the device's supply pins when supply impedance is high, supply leads are long, or excessive noise is expected on the supply lines. Minimize signal trace lengths to reduce stray capacitance. A ground plane and surface-mount components are recommended. If the REF pin is decoupled, use a new low-leakage capacitor.

Zero-Crossing Detector

Figure 4 shows a zero-crossing detector application. The MAX9027's inverting input is connected to ground, and its noninverting input is connected to a 100mV_{P-P} signal source. As the signal at the noninverting input crosses 0V, the comparator's output changes state.

Logic-Level Translator

The *Typical Application Circuit* shows an application that converts 5V logic to 3V logic levels. The MAX9028 is powered by the +5V supply voltage, and the pullup resistor for the MAX9028's open-drain output is connected to the +3V supply voltage. This configuration allows the full 5V logic swing without creating overvoltage on the 3V logic inputs. For 3V to 5V logic-level translations, simply connect the +3V supply voltage to V_{CC} and the +5V supply voltage to the pullup resistor.

UCSP, 1.8V, Nanopower, Beyond-the-Rails Comparators With/Without Reference

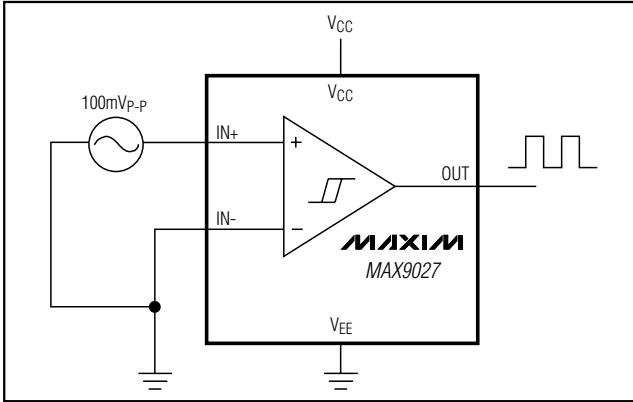
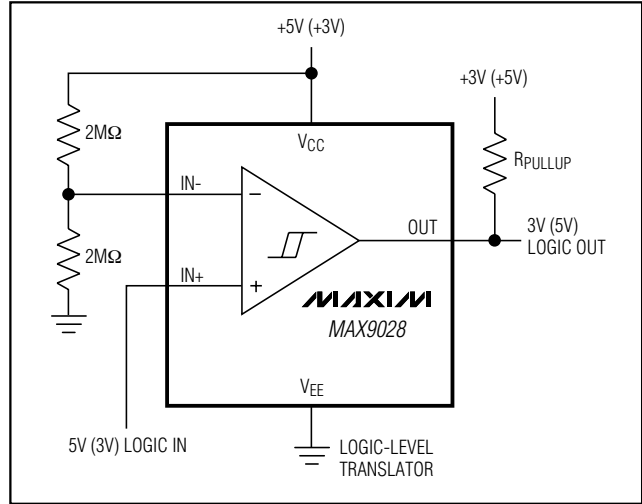

Figure 4. Zero-Crossing Detector

UCSP Applications Information

For the latest application details on UCSP construction, dimensions, tape carrier information, printed circuit board techniques, bump-pad layout, and recommended reflow temperature profiles, as well as the latest information on reliability testing results, go to Maxim's web site at www.maxim-ic.com/ucsp to find the Application Note: UCSP—A Wafer-Level Chip-Scale Package.

Typical Application Circuit



Chip Information

TRANSISTOR COUNT: 209
PROCESS: BiCMOS

UCSP, 1.8V, Nanopower, Beyond-the-Rails Comparators With/Without Reference

Package Information

(The package drawing(s) in this data sheet may not reflect the most current specifications. For the latest package outline information go to www.maxim-ic.com/packages.)

MAX9025-MAX9028

TOP VIEW

COMMON DIMENSIONS	
A	0.62±0.05-0.08
A1	0.29±0.02
A2	0.33 REF.
b	∅0.35±0.03
D1	0.50 BASIC
E1	1.00 BASIC
e	0.50 BASIC
SD	0.25 BASIC
SE	0.00 BASIC

PKG. CODE	VARIABLE DIMENSIONS		DEPOPULATED SOLDER BALLS
	D	E	
B6-1	1.00±0.05	1.52±0.05	NONE
B6-2	1.00±0.05	1.52±0.05	B2
B6-3	1.05±0.05	1.57±0.05	NONE
B6-4	1.05±0.05	1.57±0.05	B2
B6-5	0.97±0.05	1.46±0.05	NONE
B6-6	1.16±0.05	1.57±0.05	NONE

NOTES:

- ALL DIMENSIONS ARE IN MILLIMETERS.
- PRODUCT MARKING: NUMBER OF CHARACTERS AND LINES VARY PER PRODUCT.

BOTTOM VIEW

SIDE VIEW

PROPRIETARY INFORMATION
TITLE: PACKAGE OUTLINE, 3x2 UCSP
APPROVAL: _____ DOCUMENT CONTROL NO. 21-0097 REV: G 1/1

Note: The MAX9025EBT-MAX9028EBT use Package Code B6-1.

Maxim cannot assume responsibility for use of any circuitry other than circuitry entirely embodied in a Maxim product. No circuit patent licenses are implied. Maxim reserves the right to change the circuitry and specifications without notice at any time.

Maxim Integrated Products, 120 San Gabriel Drive, Sunnyvale, CA 94086 408-737-7600 _____ 13