

## FEATURES

- Gain-Bandwidth Product: 50MHz
- Unity-Gain Stable
- Slew Rate: 165V/ $\mu$ s
- Output Current:  $\pm$ 20mA
- Low Supply Current: 12mA
- High Open-Loop Gain: 7.5V/mV
- Low Cost
- Single Supply 5V Operation
- Industry Standard Pinout
- Output Shutdown

## APPLICATIONS

- Video Cable Drivers
- Video Signal Processing
- Fast Peak Detectors
- Fast Integrators
- Video Cable Drivers
- Pulse Amplifiers

## DESCRIPTION

The LT<sup>®</sup>1195 is a video operational amplifier optimized for operation on single 5V and  $\pm$ 5V supplies. Unlike many high speed amplifiers, the LT1195 features high open-loop gain, over 75dB, and the ability to drive heavy loads to a full power bandwidth of 8.5 MHz at 6V<sub>P-P</sub>. The LT1195 has a unity-gain stable bandwidth of 50MHz, a 60° phase margin and consumes only 12mA of supply current, making it extremely easy to use.

Because the LT1195 is a true operational amplifier, it is an ideal choice for wideband signal conditioning, fast integrators, peak detectors, active filters, and applications requiring speed, accuracy, and low cost.

The LT1195 is a low power version of the popular LT1190, and is available in 8-pin miniDIPs and SO packages with standard pinouts. The normally unused Pin 5 is used for a shutdown feature that shuts off the output and reduces power dissipation to a mere 15mW.

 , LTC and LT are registered trademarks of Linear Technology Corporation

## TYPICAL APPLICATION

Fast Pulse Detector

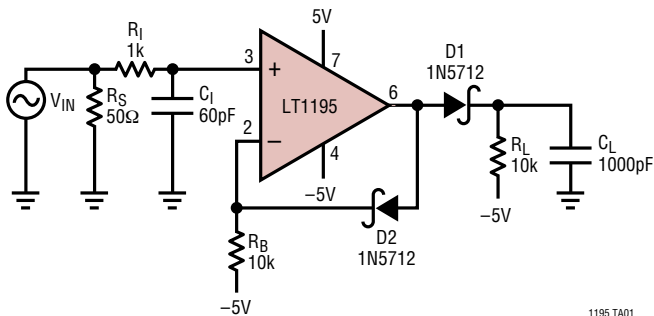

Pulse Detector Response

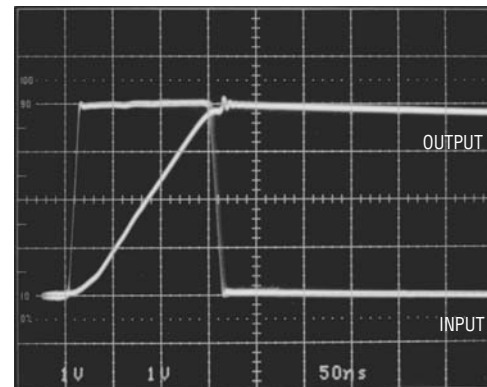

## ABSOLUTE MAXIMUM RATINGS

(Note 1)

Total Supply Voltage ( $V^+$ to $V^-$ ) .....	18V
Differential Input Voltage .....	$\pm 6V$
Input Voltage .....	$\pm V_S$
Output Short-Circuit Duration (Note 2) .....	Continuous
Operating Temperature Range	
LT1195M ( <b>OBSOLETE</b> ) .....	$-55^\circ\text{C}$ to $125^\circ\text{C}$
LT1195C .....	$0^\circ\text{C}$ to $70^\circ\text{C}$
Junction Temperature (Note 3)	
Plastic Package (CN8, CS8) .....	$150^\circ\text{C}$
Ceramic Package (CJ8, MJ8) ( <b>OBSOLETE</b> ) .....	$175^\circ\text{C}$
Storage Temperature Range .....	$-65^\circ\text{C}$ to $150^\circ\text{C}$
Lead Temperature (Soldering, 10 sec) .....	$300^\circ\text{C}$

## PACKAGE/ORDER INFORMATION

<p>N8 PACKAGE 8-LEAD PDIP</p> <p>S8 PACKAGE 8-LEAD PLASTIC SO</p> <p><math>T_{JMAX} = 150^\circ\text{C}</math>, <math>\theta_{JA} = 100^\circ\text{C/W}</math> (N8) <math>T_{JMAX} = 150^\circ\text{C}</math>, <math>\theta_{JA} = 150^\circ\text{C/W}</math> (S8)</p> <p>J8 PACKAGE 8-LEAD CERDIP</p> <p><math>T_{JMAX} = 150^\circ\text{C}</math>, <math>\theta_{JA} = 100^\circ\text{C/W}</math> (J8)</p> <p><b>OBSOLETE PACKAGE</b> Consider the N8 or S8 Package for Alternate Source</p>	ORDER PART NUMBER
	LT1195CN8 LT1195CS8
	S8 PART MARKING
	1195
	ORDER PART NUMBER
	LT1195MJ8 LT1195CJ8

Consult LTC Marketing for parts specified with wider operating temperature ranges.

## $\pm 5V$ ELECTRICAL CHARACTERISTICS

$T_A = 25^\circ\text{C}$

$V_S = \pm 5V$ ,  $C_L \leq 10pF$ , Pin 5 open circuit, unless otherwise noted.

SYMBOL	PARAMETER	CONDITIONS	LT1195M/C			UNITS
			MIN	TYP	MAX	
$V_{OS}$	Input Offset Voltage	J8, N8 Package		3.0	8.0	mV
		S8 Package		3.0	10.0	mV
$I_{OS}$	Input Offset Current			0.2	1.0	$\mu\text{A}$
$I_B$	Input Bias Current			$\pm 0.5$	$\pm 2.0$	$\mu\text{A}$
$e_n$	Input Noise Voltage	$f_0 = 10\text{kHz}$		70		$\text{nV}/\sqrt{\text{Hz}}$
$i_n$	Input Noise Current	$f_0 = 10\text{kHz}$		2		$\text{pA}/\sqrt{\text{Hz}}$
$R_{IN}$	Input Resistance	Differential Mode		230		$\text{k}\Omega$
		Common Mode		20		$\text{M}\Omega$
$C_{IN}$	Input Capacitance	$A_V = 1$		2.2		$\text{pF}$
	Input Voltage Range	(Note 4)	-2.5		3.5	V
CMRR	Common Mode Rejection Ratio	$V_{CM} = -2.5$ to $3.5V$	60	85		dB
PSRR	Power Supply Rejection Ratio	$V_S = \pm 2.375V$ to $\pm 8V$	60	85		dB
$A_{VOL}$	Large-Signal Voltage Gain	$R_L = 1k$ , $V_{OUT} = \pm 3V$	2.0	7.5		$\text{V}/\text{mV}$
		$R_L = 150\Omega$ , $V_{OUT} = \pm 3V$	0.5	1.5		$\text{V}/\text{mV}$
		$V_S = \pm 8V$ , $R_L = 1k$ , $V_{OUT} = \pm 5V$		11.0		$\text{V}/\text{mV}$
$V_{OUT}$	Output Voltage Swing	$V_S = \pm 5V$ , $R_L = 1k$	$\pm 3.8$	$\pm 4.0$		V
		$V_S = \pm 8V$ , $R_L = 1k$	$\pm 6.7$	$\pm 7.0$		V
SR	Slew Rate	$A_V = -1$ , $R_L = 1k$ (Note 5, 10)	110	165		$\text{V}/\mu\text{s}$
FPBW	Full Power Bandwidth	$V_{OUT} = 6V_{P-P}$ (Note 6)		8.75		MHz
GBW	Gain-Bandwidth Product			50		MHz
$t_{r1}$ , $t_{f1}$	Rise Time, Fall Time	$A_V = 50$ , $V_{OUT} = \pm 1.5V$ , 20% to 80% (Note 10)	125	170	285	ns
$t_{r2}$ , $t_{f2}$	Rise Time, Fall Time	$A_V = 1$ , $V_{OUT} = \pm 125\text{mV}$ , 10% to 90%		3.4		ns
$t_{PD}$	Propagation Delay	$A_V = 1$ , $V_{OUT} = \pm 125\text{mV}$ , 50% to 50%		2.5		ns
	Overshoot	$A_V = 1$ , $V_{OUT} = \pm 125\text{mV}$		22		%
$t_S$	Settling Time	3V Step, 0.1% (Note 7)		220		ns
Diff $A_V$	Differential Gain	$R_L = 150\Omega$ , $A_V = 2$ (Note 8)		1.25		%
Diff Ph	Differential Phase	$R_L = 150\Omega$ , $A_V = 2$ (Note 8)		0.86		$\text{DEG}_{P-P}$

1195fa

### ±5V ELECTRICAL CHARACTERISTICS $T_A = 25^\circ\text{C}$

$V_S = \pm 5\text{V}$ ,  $C_L \leq 10\text{pF}$ , Pin 5 open circuit, unless otherwise noted.

SYMBOL	PARAMETER	CONDITIONS	LT1195M/C			UNITS
			MIN	TYP	MAX	
$I_S$	Supply Current			12	16	mA
	Shutdown Supply Current	Pin 5 at $V^-$		0.8	1.5	mA
$I_{S/D}$	Shutdown Pin Current	Pin 5 at $V^-$		5	25	$\mu\text{A}$
$t_{ON}$	Turn-On Time	Pin 5 from $V^-$ to Ground, $R_L = 1\text{k}$		160		ns
$t_{OFF}$	Turn-Off Time	Pin 5 from Ground to $V^-$ , $R_L = 1\text{k}$		700		ns

### 5V ELECTRICAL CHARACTERISTICS $T_A = 25^\circ\text{C}$

$V_S^+ = 5\text{V}$ ,  $V_S^- = 0\text{V}$ ,  $V_{CM} = 2.5\text{V}$ ,  $C_L \leq 10\text{pF}$ , Pin 5 open circuit, unless otherwise noted.

SYMBOL	PARAMETER	CONDITIONS	LT1195M/C			UNITS
			MIN	TYP	MAX	
$V_{OS}$	Input Offset Voltage	J8, N8 Package		3.0	9.0	mV
		S8 Package		3.0	11.0	mV
$I_{OS}$	Input Offset Current			0.2	1.0	$\mu\text{A}$
$I_B$	Input Bias Current			$\pm 0.5$	$\pm 2.0$	$\mu\text{A}$
	Input Voltage Range	(Note 4)	2.0		3.5	V
CMRR	Common Mode Rejection Ratio	$V_{CM} = 2\text{V}$ to $3.5\text{V}$	60	85		dB
$A_{VOL}$	Large-Signal Voltage Gain	$R_L = 150\Omega$ to Ground, $V_{OUT} = 1\text{V}$ to $3\text{V}$	0.5	3.0		V/mV
$V_{OUT}$	Output Voltage Swing	$R_L = 150\Omega$ to Ground	$V_{OUT}$ High	3.5	3.8	V
			$V_{OUT}$ Low		0.25	0.4
SR	Slew Rate	$A_V = -1$ , $V_{OUT} = 1\text{V}$ to $3\text{V}$		140		V/ $\mu\text{s}$
GBW	Gain-Bandwidth Product			45		MHz
$I_S$	Supply Current			11	15	mA
	Shutdown Supply Current	Pin 5 at $V^-$		0.8	1.5	mA
$I_{S/D}$	Shutdown Pin Current	Pin 5 at $V^-$		5	25	$\mu\text{A}$

### ±5V ELECTRICAL CHARACTERISTICS $-55^\circ\text{C} \leq T_A \leq 125^\circ\text{C}$ , (Note 11)

$V_S = \pm 5\text{V}$ , Pin 5 open circuit, unless otherwise noted.

SYMBOL	PARAMETER	CONDITIONS	LT1195M			UNITS
			MIN	TYP	MAX	
$V_{OS}$	Input Offset Voltage			3.0	15.0	mV
$\Delta V_{OS}/\Delta T$	Input $V_{OS}$ Drift			17		$\mu\text{V}/^\circ\text{C}$
$I_{OS}$	Input Offset Current			0.2	2.0	$\mu\text{A}$
$I_B$	Input Bias Current			$\pm 0.5$	$\pm 2.5$	$\mu\text{A}$
CMRR	Common Mode Rejection Ratio	$V_{CM} = -2.5\text{V}$ to $3.5\text{V}$	55	85		dB
PSRR	Power Supply Rejection Ratio	$V_S = \pm 2.375\text{V}$ to $\pm 8\text{V}$	55	80		dB
$A_{VOL}$	Large-Signal Voltage Gain	$R_L = 1\text{k}$ , $V_{OUT} = \pm 3\text{V}$	1.50	5.0		V/mV
		$R_L = 150\Omega$ , $V_{OUT} = \pm 3\text{V}$	0.25	0.8		V/mV
$V_{OUT}$	Output Voltage Swing	$R_L = 1\text{k}$	$\pm 3.7$	$\pm 3.9$		V
$I_S$	Supply Current			12	18	mA
	Shutdown Supply Current	Pin 5 at $V^-$ , (Note 9)		0.8	2.5	mA
$I_{S/D}$	Shutdown Pin Current	Pin 5 at $V^-$		5	25	$\mu\text{A}$

**±5V ELECTRICAL CHARACTERISTICS**  $0^{\circ}\text{C} \leq T_A \leq 70^{\circ}\text{C}$

$V_S = \pm 5\text{V}$ , Pin 5 open circuit, unless otherwise noted.

SYMBOL	PARAMETER	CONDITIONS	LT1195C			UNITS
			MIN	TYP	MAX	
$V_{OS}$	Input Offset Voltage	J8, N8 Package		3.0	10.0	mV
		S8 Package		3.0	15.0	mV
$\Delta V_{OS}/\Delta T$	Input $V_{OS}$ Drift			12		$\mu\text{V}/^{\circ}\text{C}$
$I_{OS}$	Input Offset Current			0.2	1.7	$\mu\text{A}$
$I_B$	Input Bias Current			$\pm 0.5$	$\pm 2.5$	$\mu\text{A}$
CMRR	Common Mode Rejection Ratio	$V_{CM} = -2.5\text{V}$ to $3.5\text{V}$	60	85		dB
PSRR	Power Supply Rejection Ratio	$V_S = \pm 2.375\text{V}$ to $\pm 5\text{V}$	60	90		dB
$A_{VOL}$	Large-Signal Voltage Gain	$R_L = 1\text{k}$ , $V_{OUT} = \pm 3\text{V}$	2.0	7.5		V/mV
		$R_L = 150\Omega$ , $V_{OUT} = \pm 3\text{V}$	0.3	1.5		V/mV
$V_{OUT}$	Output Voltage Swing	$R_L = 1\text{k}$	$\pm 3.7$	$\pm 3.9$		V
$I_S$	Supply Current			12	17	mA
	Shutdown Supply Current	Pin 5 at $V^-$ (Note 9)		0.9	2.0	mA
$I_{S/D}$	Shutdown Pin Current	Pin 5 at $V^-$		5	25	$\mu\text{A}$

**5V ELECTRICAL CHARACTERISTICS**  $0^{\circ}\text{C} \leq T_A \leq 70^{\circ}\text{C}$

$V_S^+ = 5\text{V}$ ,  $V_S^- = 0\text{V}$ , Pin 5 open circuit, unless otherwise noted.

SYMBOL	PARAMETER	CONDITIONS	LT1195C			UNITS
			MIN	TYP	MAX	
$V_{OS}$	Input Offset Voltage	J8, N8 Package		1.0	10.0	mV
		S8 Package		1.0	15.0	mV
$\Delta V_{OS}/\Delta T$	Input $V_{OS}$ Drift			15		$\mu\text{V}/^{\circ}\text{C}$
$I_{OS}$	Input Offset Current			0.2	1.7	$\mu\text{A}$
$I_B$	Input Bias Current			$\pm 0.5$	$\pm 2.5$	$\mu\text{A}$
	Input Voltage Range	(Note 4)	2.0		3.5	V
CMRR	Common Mode Rejection Ratio	$V_{CM} = 2\text{V}$ to $3.5\text{V}$	60	85		dB
$V_{OUT}$	Output Voltage Swing	$R_L = 150\Omega$ to Ground	$V_{OUT}$ High	3.5	3.75	V
			$V_{OUT}$ Low		0.15	0.4
$I_S$	Supply Current			12	16	mA
	Shutdown Supply Current	Pin 5 at $V^-$ (Note 9)		0.9	2.0	mA
$I_{S/D}$	Shutdown Pin Current	Pin 5 at $V^-$		5	25	$\mu\text{A}$

**Note 1:** Absolute Maximum Ratings are those values beyond which the life of a device may be impaired.

**Note 2:** A heat sink may be required to keep the junction temperature below absolute maximum when the output is shorted continuously.

**Note 3:**  $T_J$  is calculated from the ambient temperature  $T_A$  and power dissipation  $P_D$  according to the following formats:

LT1195MJ8/LT1195CJ8:  $T_J = T_A + (P_D \cdot 100^{\circ}\text{C}/\text{W})$   
 LT1195N:  $T_J = T_A + (P_D \cdot 100^{\circ}\text{C}/\text{W})$   
 LT1195CS:  $T_J = T_A + (P_D \cdot 150^{\circ}\text{C}/\text{W})$

**Note 4:** Exceeding the input common mode range may cause the output to invert.

**Note 5:** Slew rate is measured between  $\pm 1\text{V}$  on the output, with  $\pm 3\text{V}$  input step.

**Note 6:** Full power bandwidth is calculated from the slew rate measurement:  $\text{FPBW} = \text{SR}/2\pi V_P$ .

**Note 7:** Settling time measurement techniques are shown in "Take the Guesswork Out of Settling Time Measurements," EDN, September 19, 1985.

**Note 8:** NTSC (3.58MHz). For  $R_L = 1\text{k}$ , Diff  $A_V = 0.3\%$ , Diff  $\text{Ph} = 0.35^{\circ}$ .

**Note 9:** See Applications Information section for shutdown at elevated temperatures. Do not operate the shutdown above  $T_J > 125^{\circ}\text{C}$ .

**Note 10:** AC parameters are 100% tested on the ceramic and plastic DIP packaged parts (J8 and N8 suffix) and are sample tested on every lot of the SO packaged parts (S8 suffix).

**Note 11:** Do not operate at  $A_V < 2$  for  $T_A < 0^{\circ}\text{C}$ .

# TYPICAL PERFORMANCE CHARACTERISTICS

**Input Bias Current vs Common Mode Voltage**

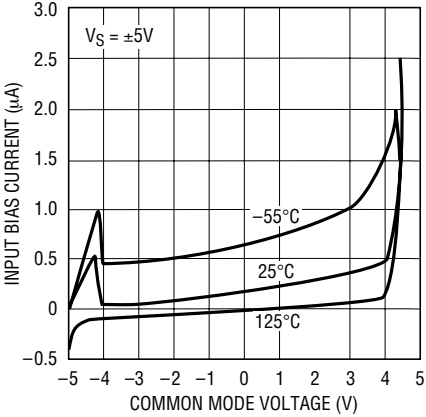

1195 G01

**Input Bias Current vs Temperature**

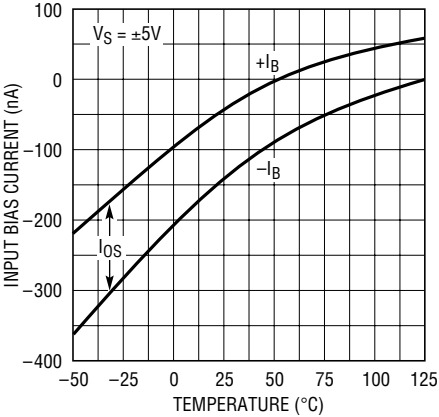

1195 G02

**Common Mode Voltage vs Temperature**

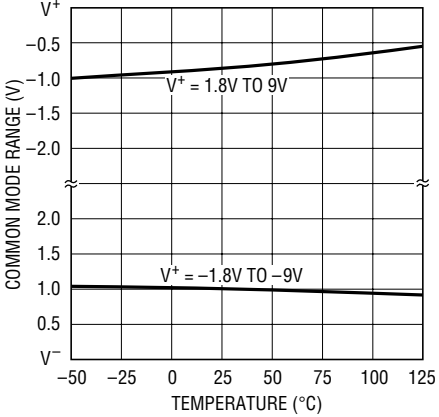

1195 G03

**Equivalent Input Noise Voltage vs Frequency**

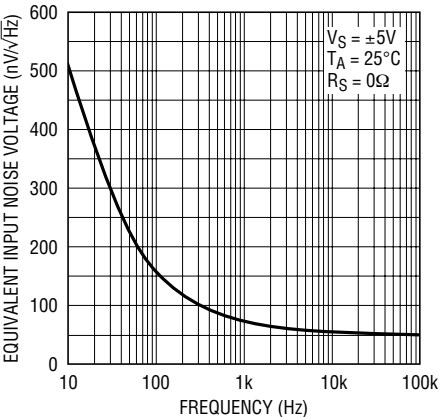

1195 G04

**Equivalent Input Noise Current vs Frequency**

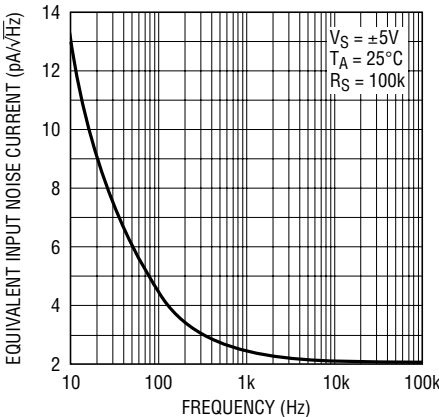

1195 G05

**Supply Current vs Supply Voltage**

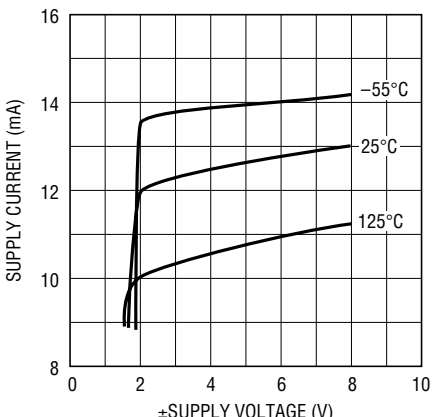

1195 G06

**Shutdown Supply Current vs Temperature**

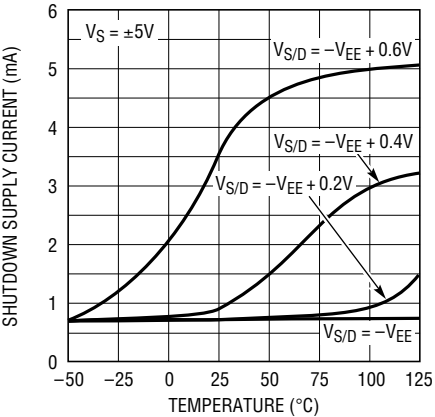

1195 G07

**Output Voltage Swing vs Load Resistance**

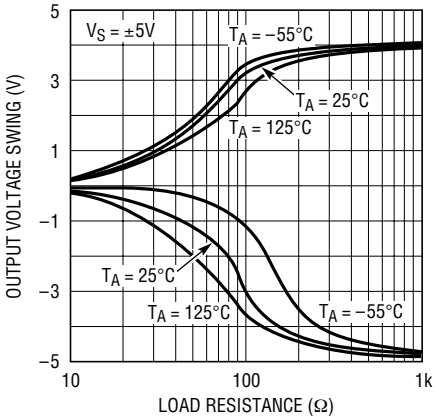

1195 G08

**Open-Loop Gain vs Temperature**

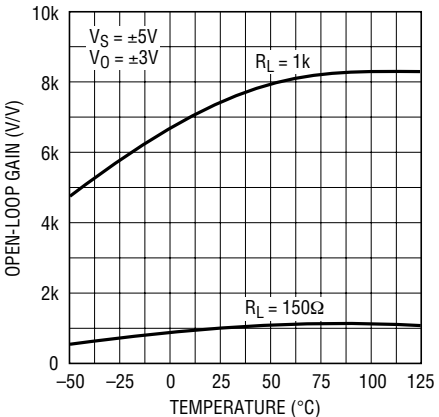

1195 G09

# TYPICAL PERFORMANCE CHARACTERISTICS

Gain and Phase vs Frequency

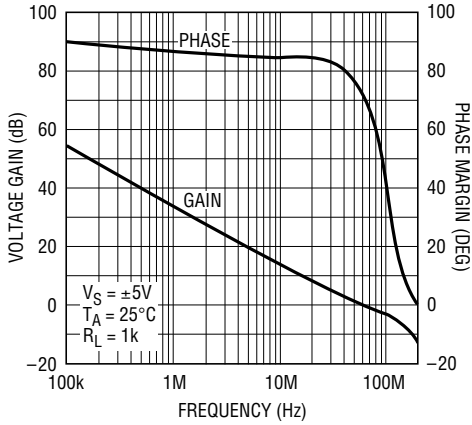

1195 G10

Open-Loop Voltage Gain vs Load Resistance

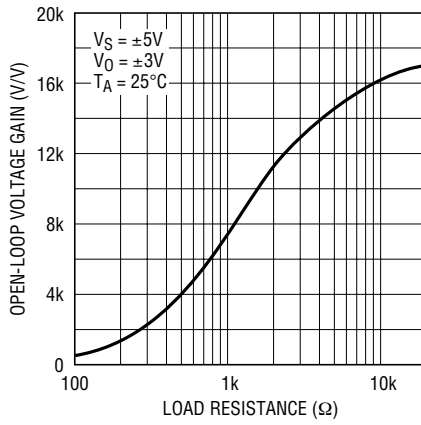

1195 G11

Gain-Bandwidth Product vs Supply Voltage

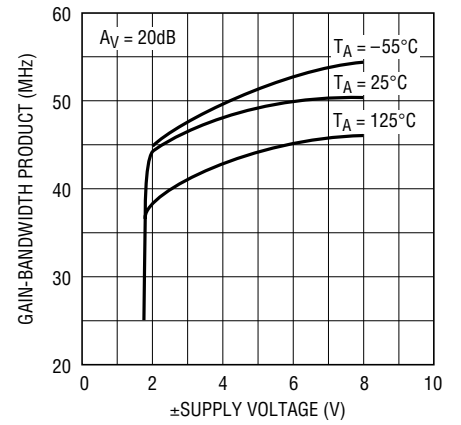

1195 G12

Unity-Gain Frequency and Phase Margin vs Temperature

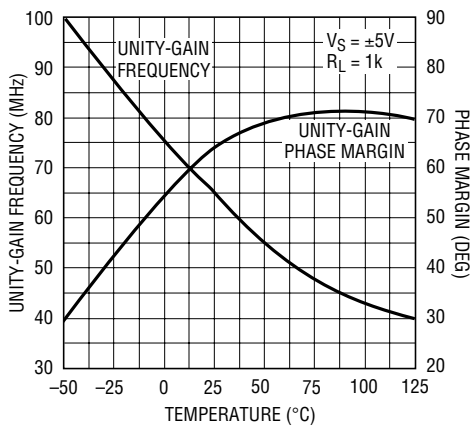

1195 G13

Output Impedance vs Frequency

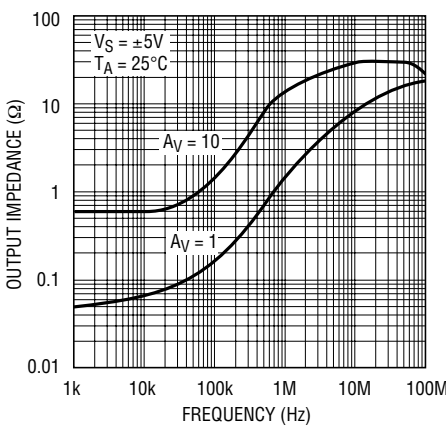

1195 G14

Common Mode Rejection Ratio vs Frequency

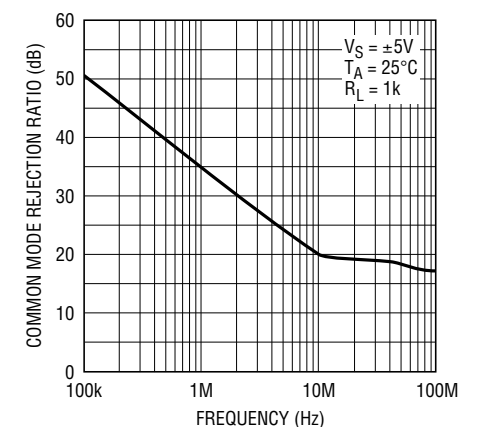

1195 G15

Power Supply Rejection Ratio vs Frequency

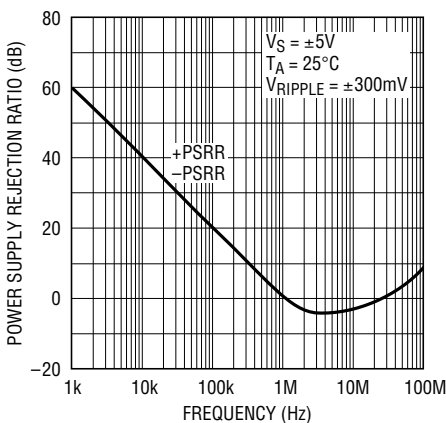

1195 G16

Output Short-Circuit Current vs Temperature

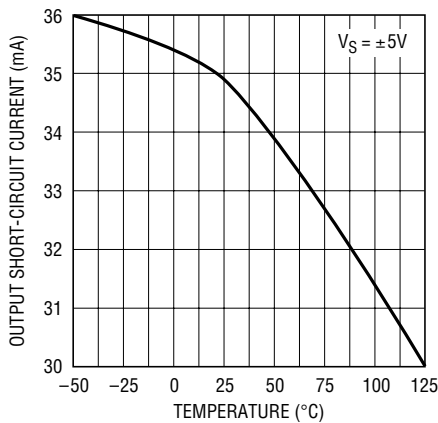

1195 G17

±Output Swing vs Supply Voltage

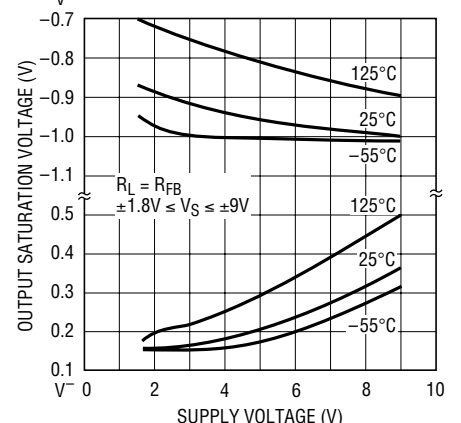

1195 G18

1195fa

# TYPICAL PERFORMANCE CHARACTERISTICS

### Slew Rate vs Temperature

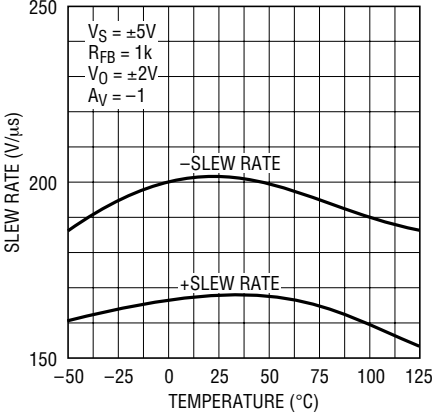

1195 G19

### Output Voltage Step vs Settling Time, $A_V = -1$

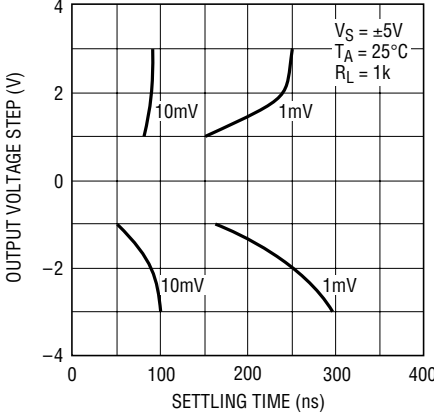

1195 G20

### Output Voltage Step vs Settling Time, $A_V = 1$

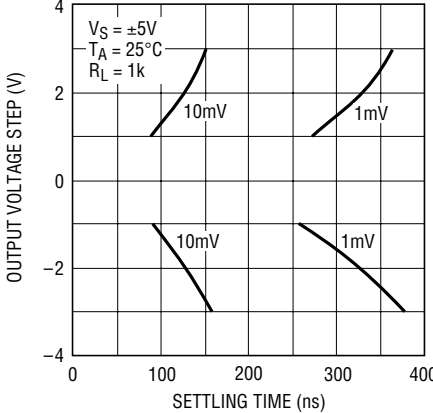

1195 G21

### Large-Signal Transient Response

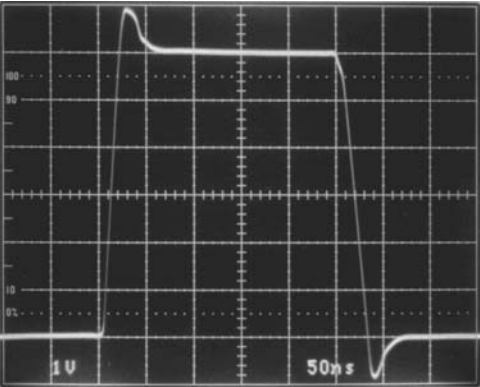

$A_V = 1, R_L = 1k$

1195 G22

### Large-Signal Transient Response

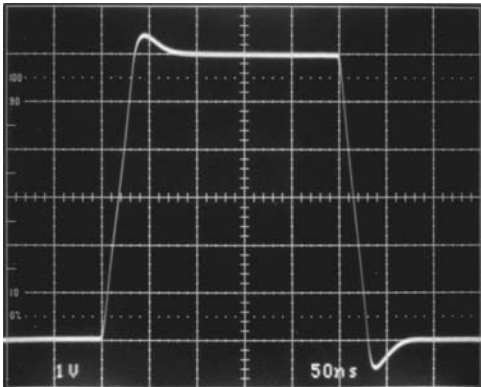

$A_V = -1, R_L = 1k$

1195 G23

### Overload Recovery

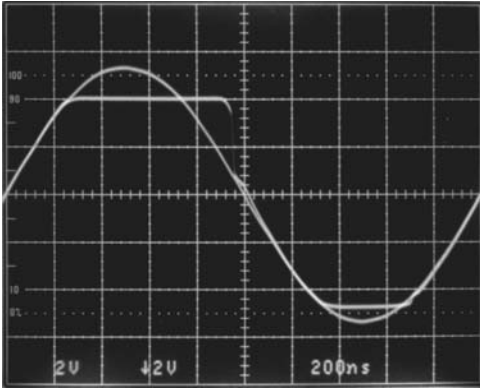

$A_V = 1, V_{IN} = 11V_{p-p}$

1195 G24

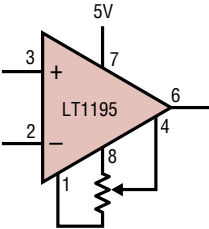

INPUT OFFSET VOLTAGE CAN BE ADJUSTED OVER A  $\pm 150mV$  RANGE WITH A 1k to 10k POTENTIOMETER.

1195 G25

## APPLICATIONS INFORMATION

### Power Supply Bypassing

The LT1195 is quite tolerant of power supply bypassing. In some applications a 0.1 $\mu$ F ceramic disc capacitor placed 0.5 inches from the amplifier is all that is required. In applications requiring good settling time, it is important to use multiple bypass capacitors. A 0.1 $\mu$ F ceramic disc in parallel with a 4.7 $\mu$ F tantalum is recommended.

### Cable Terminations

The LT1195 operational amplifier has been optimized as a low cost video cable driver. The  $\pm 20$ mA guaranteed output current enables the LT1195 to easily deliver 6V<sub>P-P</sub> into 150 $\Omega$ , while operating on  $\pm 5$ V supplies.

Double-Terminated Cable Driver

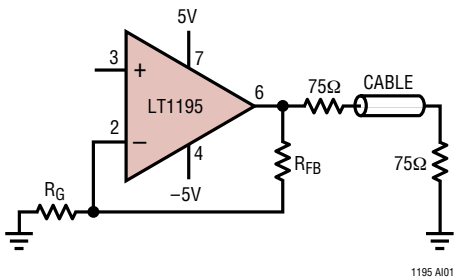

1195 AI01

Cable Driver Voltage Gain vs Frequency

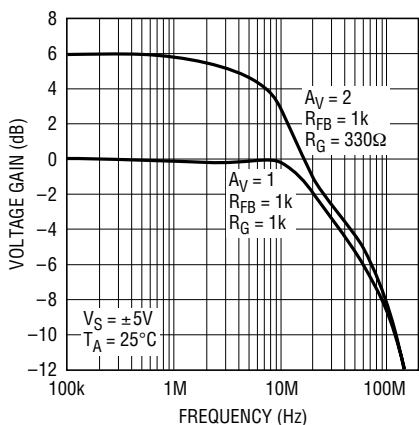

1195 AI02

When driving a cable it is important to terminate the cable to avoid unwanted reflections. This can be done in one of two ways: single termination or double termination. With single termination, the cable must be terminated at the

receiving end (75 $\Omega$  to ground) to absorb unwanted energy. The best performance can be obtained by double termination (75 $\Omega$  in series with the output of the amplifier, and 75 $\Omega$  to ground at the other end of the cable). This termination is preferred because reflected energy is absorbed at each end of the cable. When using the double termination technique it is important to note that the signal is attenuated by a factor of 2, or 6dB. This can be compensated for by taking a gain of 2, or 6dB in the amplifier.

### Using the Shutdown Feature

The LT1195 has a unique feature that allows the amplifier to be shut down for conserving power, or for multiplexing several amplifiers onto a common cable. The amplifier will shutdown by taking Pin 5 to  $V^-$ . In shutdown, the amplifier dissipates 15mW while maintaining a true high impedance output state of 15k in parallel with the feedback resistors. The amplifiers must be used in a noninverting configuration for MUX applications. In inverting configurations the input signal is fed to the output through the feedback components. The following scope photos show that with very high  $R_L$ , the output is truly high impedance; the output slowly decays toward ground. Additionally, when the output is loaded with as little as 1k the amplifier shuts off in 700ns. This shutoff can be under the control of HC CMOS operating between 0V and  $-5$ V.

Output Shutdown

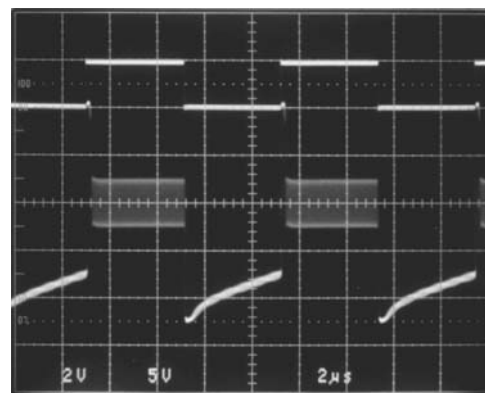

1MHz SINE WAVE GATED OFF WITH SHUTDOWN PIN  
 $A_V = 1$ ,  $R_L =$  SCOPE PROBE

1195 AI03



APPLICATIONS INFORMATION

Output Shutdown

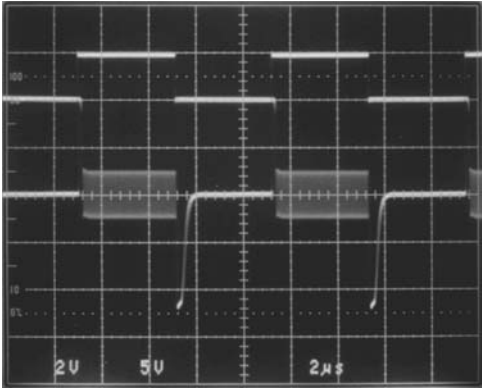

1MHz SINE WAVE GATED OFF WITH SHUTDOWN PIN  
 $A_v = 1, R_L = 1k$

1195 AI04

Detecting Pulses

The front page shows a circuit for detecting very fast pulses. In this open-loop design, the detector diode is D1 and a level shifting or compensating diode is D2. A load resistor  $R_L$  is connected to  $-5V$ , and an identical bias resistor  $R_B$  is used to bias the compensating diode. Equal value resistors ensure that the diode drops are equal. A very fast pulse will exceed the amplifier slew rate and cause a long overload recovery time. Some amount of  $dV/dt$  limiting on the input can help this overload condition, however too much will delay the response. Also shown is the response to a  $4V_{p-p}$  input that is  $150ns$  wide. The maximum output slew rate in the photo is  $30V/\mu s$ . This rate is set by the  $30mA$  current limit driving  $1000pF$ .

Operation on Single 5V Supply

The LT1195 has been optimized for a single 5V supply. This circuit amplifies standard composite video ( $1V_{p-p}$  including sync) by 2 and drives a double-terminated  $75\Omega$  cable. Resistors R1 and R2 bias the amplifier at 2V, allowing the sync pulses to stay within the common mode range of the amplifier. Large coupling capacitors are required to pass the low frequency sidebands of the composite signal. A multiburst response and vector plot standard color burst are shown.

Single 5V Video Amplifier

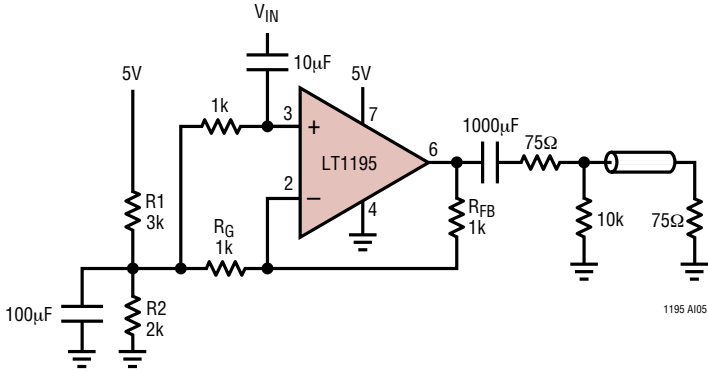

1195 AI05

Video Multiburst at Pin 6 of Amplifier

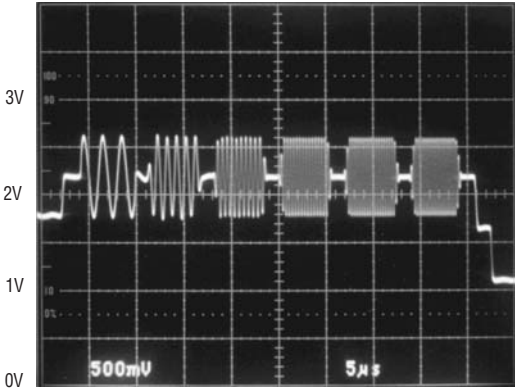

1195 AI06

Vector Plot of Standard Color Burst

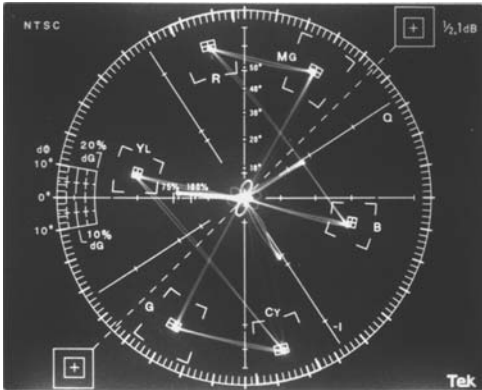

1195 AI07

## APPLICATIONS INFORMATION

### Send Color Video Over Twisted-Pair

With an LT1195 it is possible to send and receive color composite video signals more than 1000 feet on a low cost twisted-pair. A bidirectional "video bus" consists of the LT1195 op amp and the LT1187 video difference amplifier. A pair of LT1195s at TRANSMIT 1, is used to generate differential signals to drive the line which is back-terminated in its characteristic impedance. The LT1187 twisted-pair receiver, converts signals from differential to single-ended. Topology of the LT1187 provides for cable compensation at the amplifier's feedback node as shown. In this case, 1000 feet of twisted-pair is compensated with 1000pF and 50Ω to boost the 3dB bandwidth of the system from 750kHz to 4MHz. This bandwidth is adequate to pass a 3.58MHz chrome subcarrier and the 4.5MHz sound subcarrier. Attenuation in the cable can be compensated by lowering the gain set resistor  $R_G$ . At TRANSMIT 2, another pair of LT1195s serve the dual function to provide cable termination via low output impedance and generate differential signals for TRANSMIT 2. Cable termination is made up of 15Ω and 33Ω attenuators to reduce the differential input signal to the LT1187. Maximum input signal for the LT1187 is 760mV<sub>P-P</sub>.

**1.5MHz Square Wave Input and Unequalized Response Through 1000 Feet of Twisted-Pair**

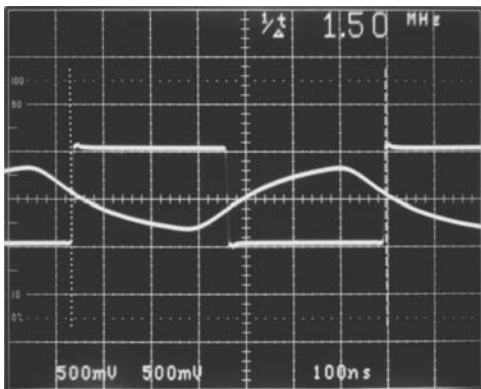

1195 A108

**1.5MHz Square Wave Input and Equalized Response Through 1000 Feet of Twisted-Pair**

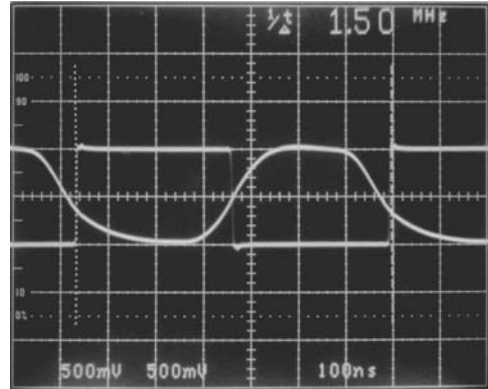

1195 A109

**Multiburst Pattern Passed Through 1000 Feet of Twisted-Pair**

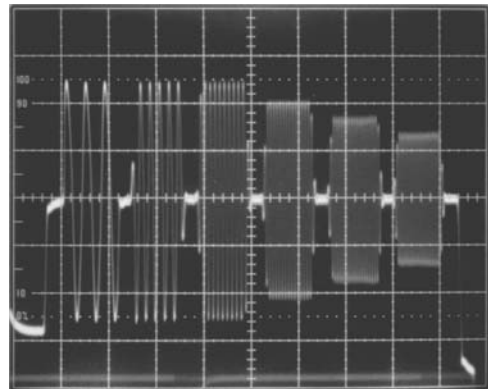

1195 A110

**Vector Plot of Standard Color Burst Through 1000 Feet of Twisted-Pair**

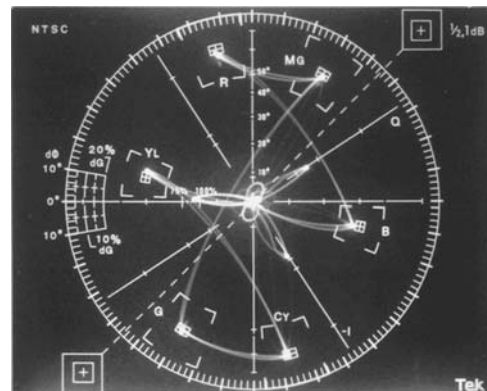

1195 A111

# APPLICATIONS INFORMATION

## Bidirectional Video Bus

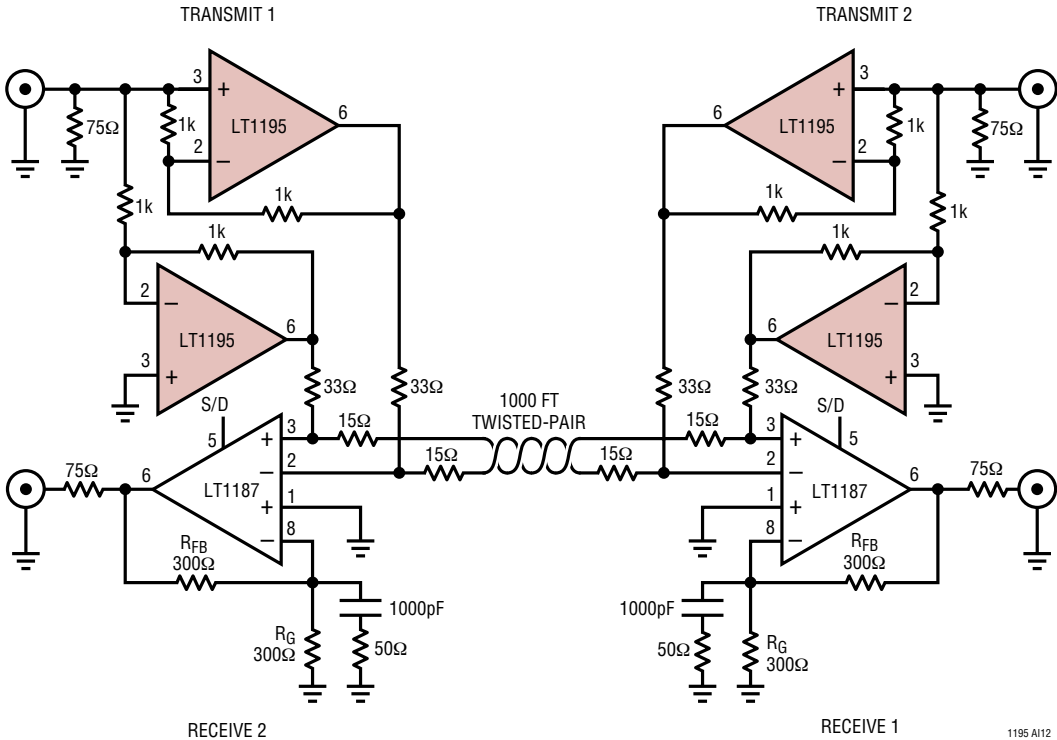

1195 AI12

# SIMPLIFIED SCHEMATIC

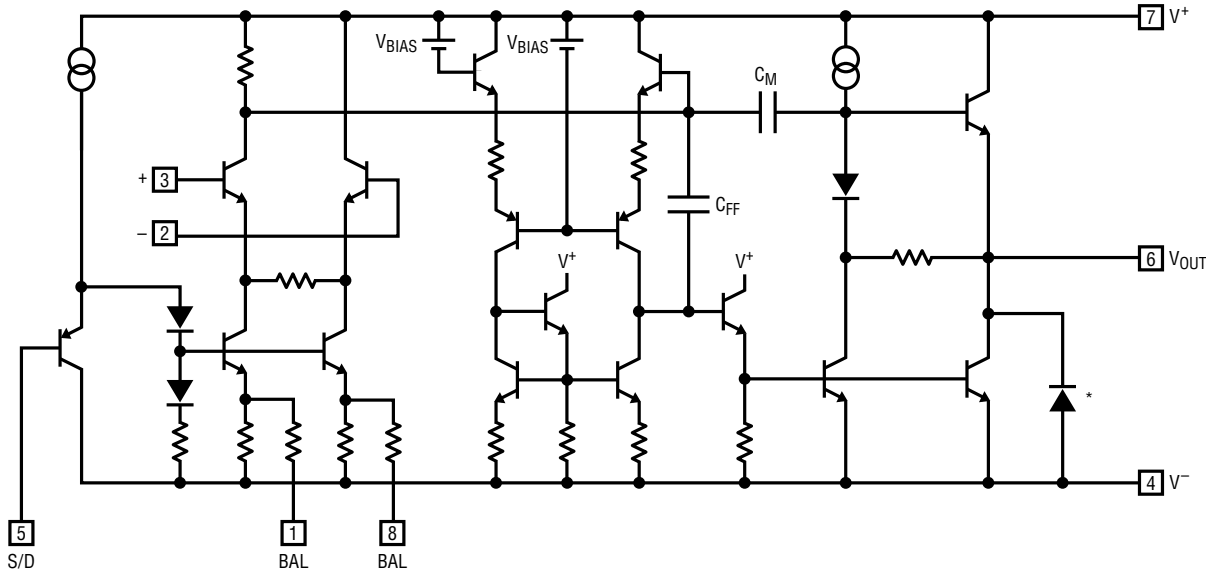

\* SUBSTRATE DIODE, DO NOT FORWARD BIAS

1195 SS

# PACKAGE DESCRIPTION

