

LM4682 Boomer® Audio Power Amplifier Series

10 Watt Stereo CLASS D Audio Power Amplifier with Stereo Headphone Amplifier and DC Volume Control

General Description

The LM4682 is a fully integrated single supply, high efficiency audio power amplifier solution. The LM4682 utilizes a proprietary balanced pulse-width modulation technique that lowers output noise and THD and improves PSRR when compared to conventional pulse width modulators.

The LM4682 also features a stereo headphone amplifier that delivers 60mW into a 32Ω headset with less than 0.5% THD.

The LM4682's DC volume control has a +30dB to -48dB range when speakers are driven and a range of +13dB to -65dB when headphones are connected. All amplifiers are protected by thermal shutdown. Additionally, all amplifiers incorporate output current limiting function to protect their outputs from short circuit.

The LM4682 features a low-power consumption shutdown mode. And its efficiency reaches 85% for a 10W output power with an 8Ω load. External heatsink is not required when playing music. The IC features click and pop reduction circuitry that minimizes audible popping during device turn-on and turn-off. The LM4682 is available in a 48-lead LLP package, ideal for portable and desktop computer applications.

Key Specifications

- P_O at THD+N = 10%, $V_{DD} = 14V$ 10W (typ)
- THD+N at 1kHz at 6W into 8Ω (Power Amp) 0.2% (typ)
- Efficiency at 7W into 8Ω 84% (typ)
- Total quiescent power supply current 52mA (typ)
- Total shutdown power supply current 0.1mA (typ)
- THD+N 1kHz, 20mW, 32Ω (Headphone) 0.02% (typ)
- Single supply range 8.5V to 15V

Features

- Pulse-width modulator.
- DC Volume Control
- Stereo headphone amplifier.
- "Click and pop" suppression circuitry.
- Micropower shutdown mode.
- 48 lead LLP package (No heatsink required).

Applications

- Flat Panel Displays
- Televisions
- Multimedia Monitors

Block Diagram

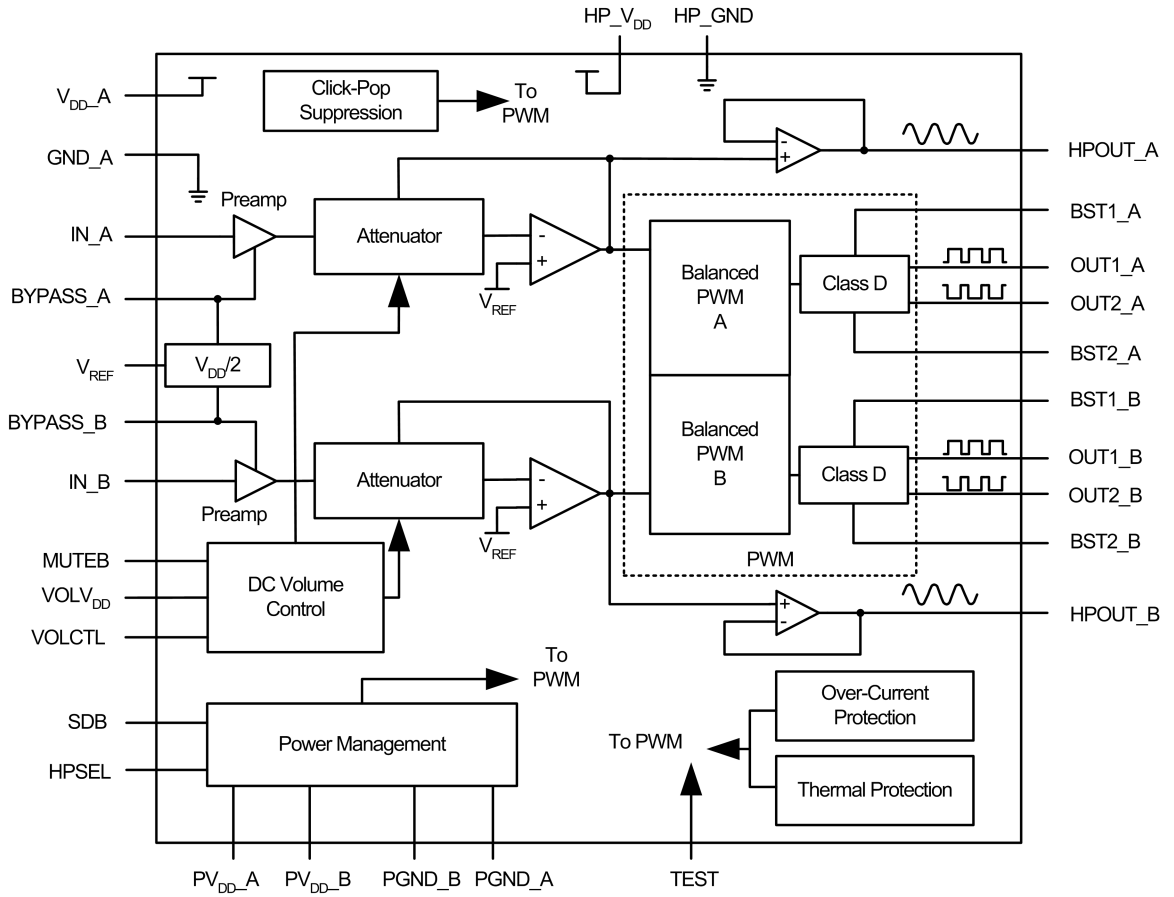

Block Diagram for LM4682

20119622

Connection Diagram

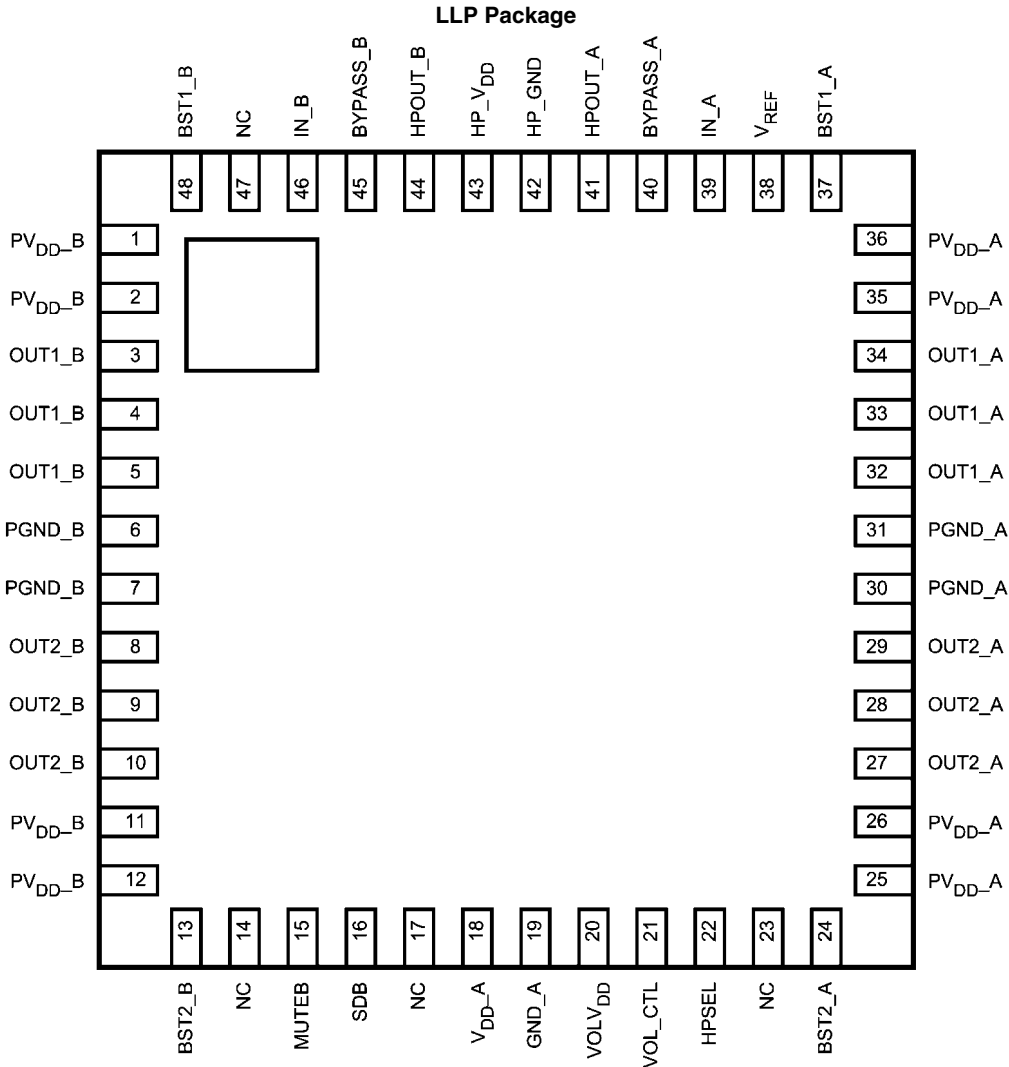

20119618

Top View
Order Number LM4682SQ
See NS Package Number SQA48A
(LLP Package)

Typical Application

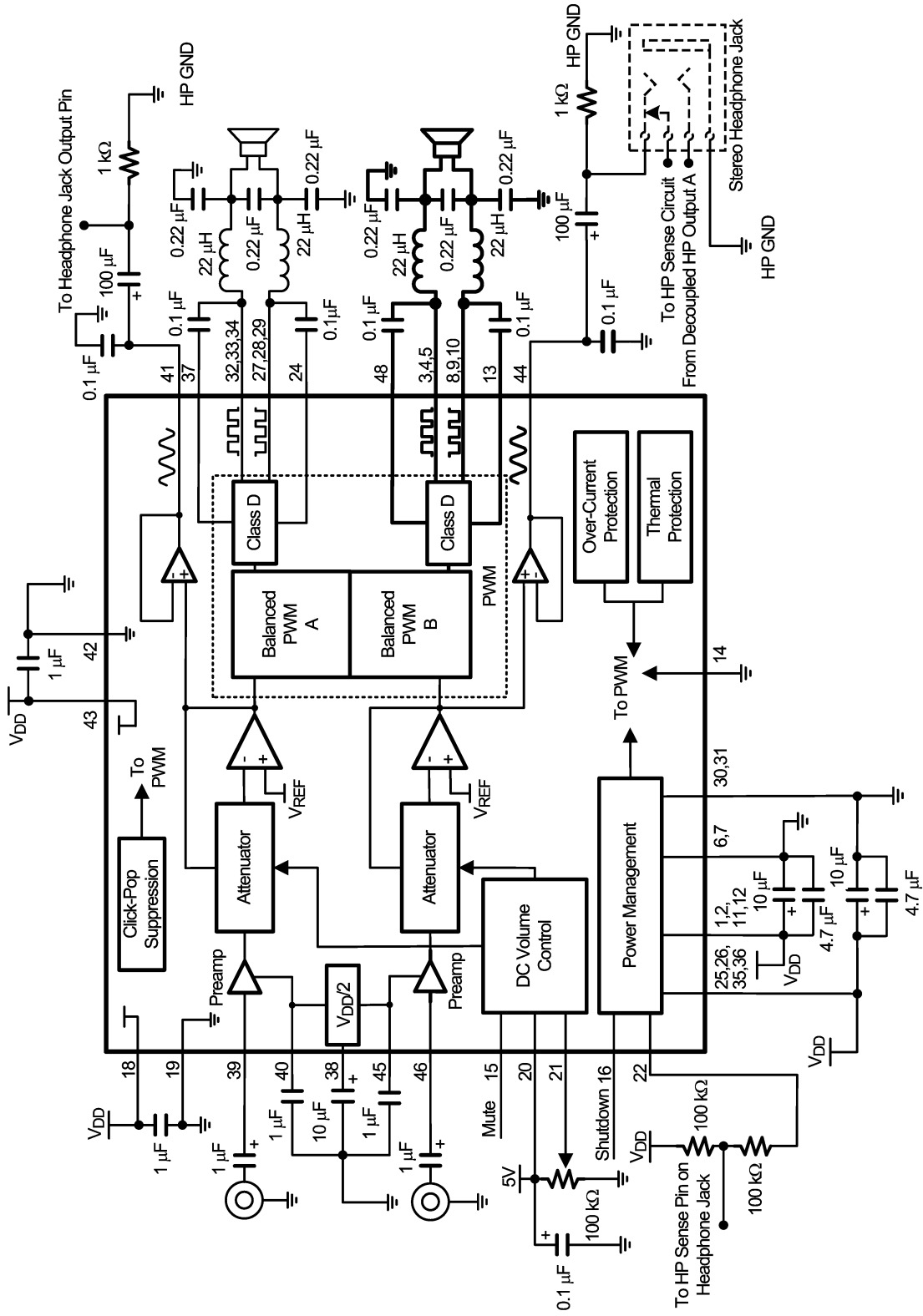

FIGURE 1. Typical Stereo Audio Amplifier with Headphone Selection Circuit

20119630

Absolute Maximum Ratings (Note 2)

If Military/Aerospace specified devices are required, please contact the National Semiconductor Sales Office/Distributors for availability and specifications.

Supply Voltage	15.5V
Input Voltage	-0.3V to $V_{DD} + 0.3V$
Power Dissipation (Note 3)	Internally Limited
ESD Susceptibility (Note 4)	2000V
ESD Susceptibility (Note 5)	200V
Junction Temperature (Note 6)	150°C
Storage Temperature	$-65^{\circ}\text{C} \leq T_A \leq 150^{\circ}\text{C}$

Soldering Information
LLP Package

Vapor Phase (60 sec.) 215°C

Infrared (15 sec.) 220°C

See AN-450 "Surface Mounting and their Effects on Product Reliability" for other methods of soldering surface mount devices.

Operating Ratings (Notes 1, 2)

Temperature Range

$$T_{\text{MIN}} \leq T_A \leq T_{\text{MAX}} \quad -40^{\circ}\text{C} \leq T_A \leq +85^{\circ}\text{C}$$

Supply Voltage $8.5\text{V} \leq V_{DD} \leq 15\text{V}$

Thermal Resistance (LLP Package)

$$\theta_{JA} \quad 28^{\circ}\text{C/W}$$

$$\theta_{JC} \quad 20^{\circ}\text{C/W}$$

Electrical Characteristics (Notes 1, 2, 7)

The following specifications apply for $V_{DD} = 12\text{V}$, $V_{OLV_{DD}} = 5\text{V}$, $R_L = 8\Omega$, LC filter values as shown in Figure 1, unless otherwise specified.

Limits apply for $T_A = 25^{\circ}\text{C}$.

Symbol	Parameter	Conditions	LM4682			Units
			Typical	Max	Min	
V_{DD}	Operating Supply Voltage Range		12	15	8.5	V
I_S	Quiescent Power Supply Current, Class D Mode	$V_{IN} = 0V_{RMS}$, $V_{HPSEL} = 0V$	52	70		mA
	Quiescent Power Supply Current, Headphone Mode	$V_{IN} = 0V_{RMS}$, $V_{HPSEL} = 12V$	30	40		mA
I_{SD}	Quiescent Power Supply Current, Shutdown Mode	SDB = 0V	0.1			mA
R_{IN}	Input Resistance in Both Modes		8			k Ω
$V_{OLV_{DD}}$	DC Reference Supply Voltage			5.5	3	V
V_{IH}	Minimum Logic High Input Voltage	SDB, MUTEb pins			$0.7 \times V_{OLV_{DD}}$	V
V_{IL}	Maximum Logic Low Input Voltage			$0.3 \times V_{OLV_{DD}}$		V
V_{HPIH}	HP Sense High Input Voltage				$V_{DD} - 1$	V
V_{HPIL}	HP Sense Low Input Voltage			$V_{DD}/2$		V
Power Amplifiers						
P_{OR}	Output Power, Per Channel	THD+N $\leq 1\%$, $f_{IN} = 1\text{kHz}$	6.0		5.5	W
P_{D1}	Power Dissipation	$P_O = 7\text{W/Chan}$, $f_{IN} = 1\text{kHz}$	2.6			W
E_{FF1}	Efficiency	$P_O = 7\text{W/Chan}$, $f_{IN} = 1\text{kHz}$	84.4			%
THD+N	Harmonic Distortion + Noise	$P_O = 6\text{W/Chan}$, $f_{IN} = 1\text{kHz}$	0.2			%
V_{NOISE}	Output Noise Voltage, RMS. A-Weighted	$R_{SOURCE} = 50\Omega$, $C_{IN} = 1\mu\text{F}$, BW = 8Hz to 22kHz A-weighted, input referred	13			μV
PSRR	Power Supply Rejection Ratio	$V_{RIPPLE} = 200\text{mVpp}$, 1kHz, $V_{IN} = 0$, input referred				dB
		f = 50Hz	94			
		f = 60Hz	94			
		f = 100Hz	93			
		f = 120Hz	93			
		f = 1kHz	84			

Symbol	Parameter	Conditions	LM4682			Units
			Typical	Max	Min	
Headphone Amplifiers						
P_O	Power Out Per Channel	$THD+N \leq 1\%$, $R_L = 32\Omega$, $f_{IN} = 1kHz$	80		60	mW
THD+N	Distortion + Noise	$P_O = 20mW$, $R_L = 32\Omega$, $f_{IN} = 1kHz$	0.02			%
V_{NOISE}	Output Noise Voltage, RMS	$R_{IN} = 50\Omega$, $C_{IN} = 1\mu F$, BW = 20Hz to 20kHz A-weighted, input referred	9			μV
PSRR	Power Supply Rejection Ratio (Referred to Input)	200mV, 1kHz, $V_{IN} = 0$, $R_L = 32\Omega$	88			dB

Electrical Characteristics for Volume Control (Notes 1, 2)

The following specifications apply for $V_{DD} = 12V$. Limits apply for $T_A = 25^\circ C$.

Symbol	Parameter	Conditions	LM4682		Units (Limits)
			Typical (Note 8)	Limit (Note 7)	
C_{RANGE}	Gain Range	VOL_CTL voltage = $VOLV_{DD}$ voltage, No Load			
		Power Amplifier	30	29	dB (min)
		Headphone Amplifier	13	12	dB (min)
		VOL_CTL voltage = $0.069 \times VOLV_{DD}$ No Load			
A_M	Mute Gain	Power Amplifier	-48	-46	dB (min)
		Headphone Amplifier	-65	-63	dB (min)
		V_{MUTE} voltage = 0V, No Load			
		Power Amplifier	-80	-60	dB (max)
		Headphone Amplifier	-70	-60	dB (max)

Note 1: All voltages are measured with respect to the ground pin, unless otherwise specified.

Note 2: "Absolute Maximum Ratings" indicate limits beyond which damage to the device may occur. "Operating Ratings" indicate conditions for which the device is functional, but do not guarantee specific performance limits. "Electrical Characteristics" state DC and AC electrical specifications under particular test conditions which guarantee specific performance limits. This assumes that the device is within the Operating Ratings. Specifications are not guaranteed for parameters where no limit is given, however, the typical value is a good indication of device performance.

Note 3: For operating at case temperatures above $25^\circ C$, the device must be derated based on a $150^\circ C$ maximum junction temperature and a thermal resistance of $\theta_{JA} = 28^\circ C/W$ (junction to ambient).

Note 4: Human body model, 100pF discharged through a 1.5k Ω resistor. Device pin 16 has ESD HBM rating = 1500V.

Note 5: Machine Model 220pF–240pF discharged through all pins.

Note 6: The operating junction temperature maximum is $150^\circ C$.

Note 7: Limits are guaranteed to National's AOQL (Average Outgoing Quality Level).

Note 8: Typicals are measured at $25^\circ C$ and represent the parametric norm.

Typical Performance Characteristics (Power Amplifier)

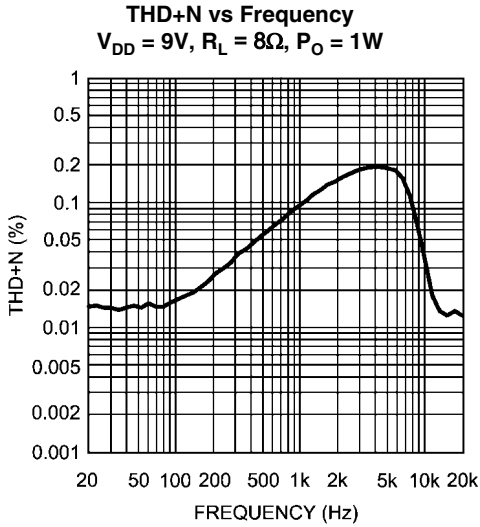

20119658

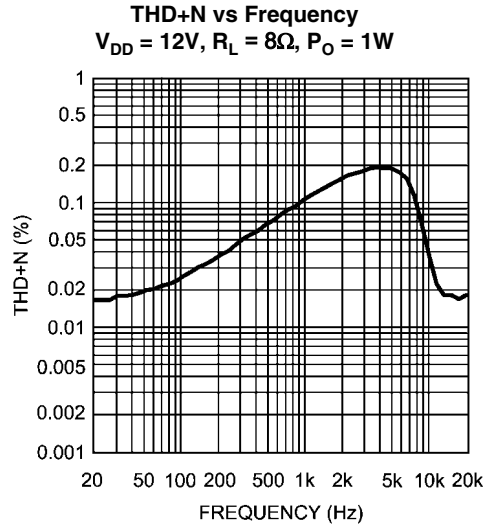

20119659

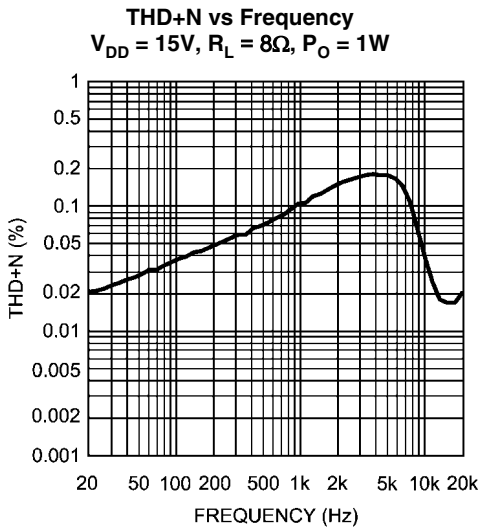

20119660

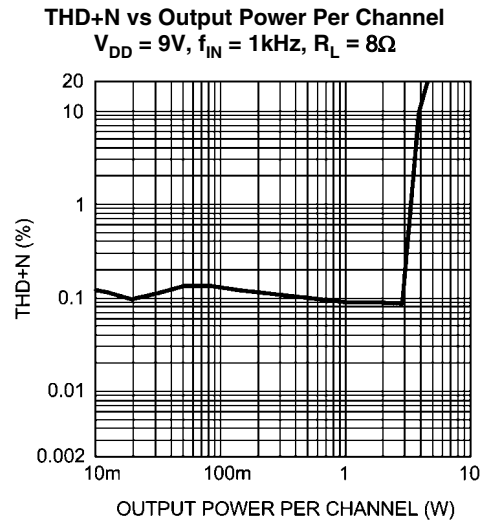

20119661

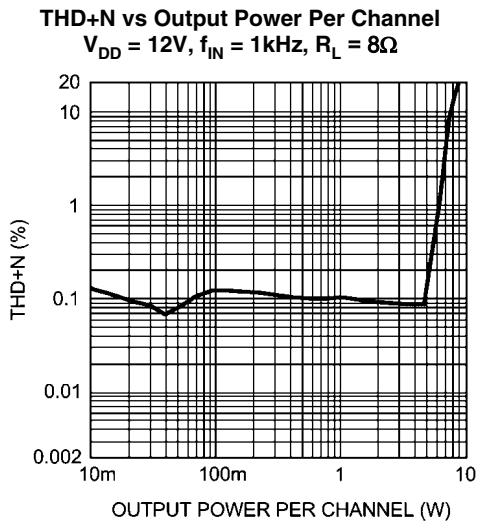

20119662

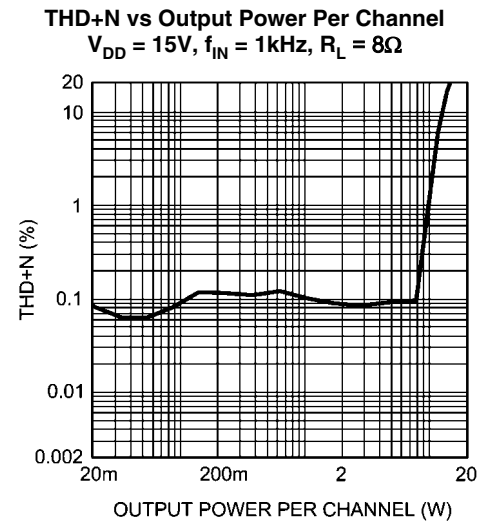

20119663

THD+N vs Output Power Per Channel
 $V_{DD} = 12V, f_{IN} = 10kHz, R_L = 8\Omega$

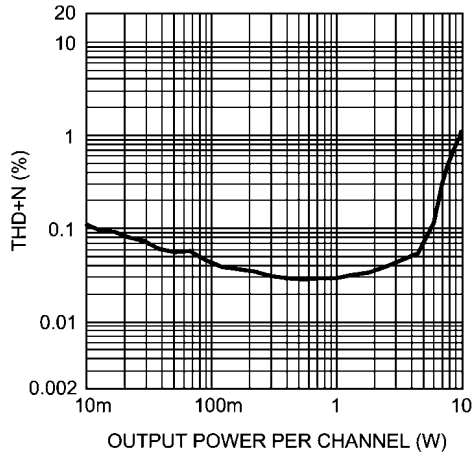

20119664

THD+N vs Output Power Per Channel
 $V_{DD} = 12V, f_{IN} = 20Hz, R_L = 8\Omega$

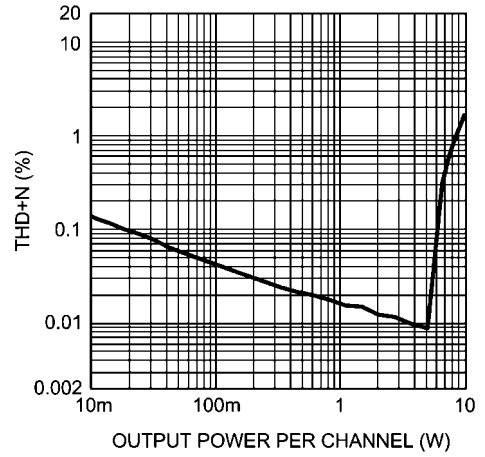

20119665

Output Power vs Supply Voltage
 $f_{IN} = 1kHz, R_L = 8\Omega$

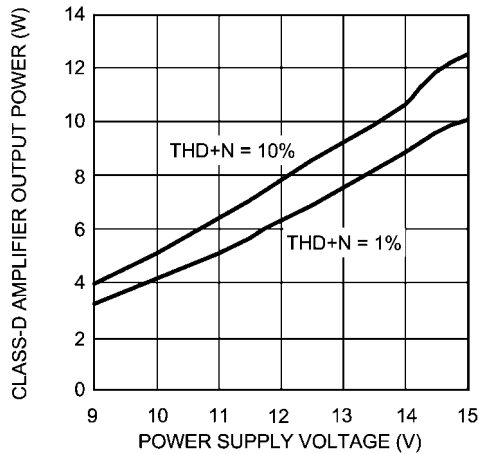

20119667

Amplifiers Gain vs Frequency
 $V_{DD} = 9V, R_L = 8\Omega, P_O = 1W$

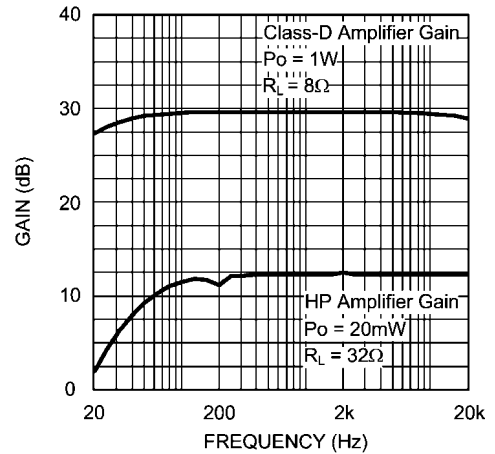

20119647

Amplifiers Gain vs Frequency
 $V_{DD} = 12V, R_L = 8\Omega, P_O = 1W$

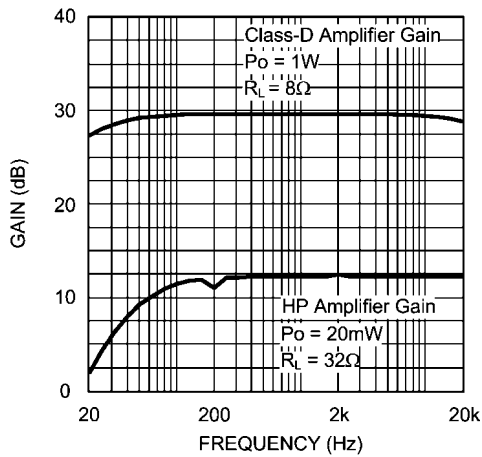

20119648

Amplifiers Gain vs Frequency
 $V_{DD} = 15V, R_L = 8\Omega, P_O = 1W$

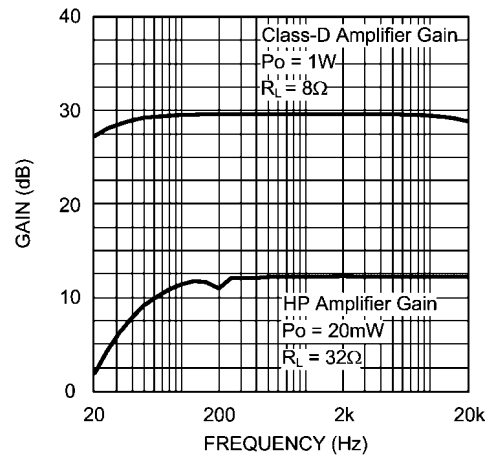

20119649

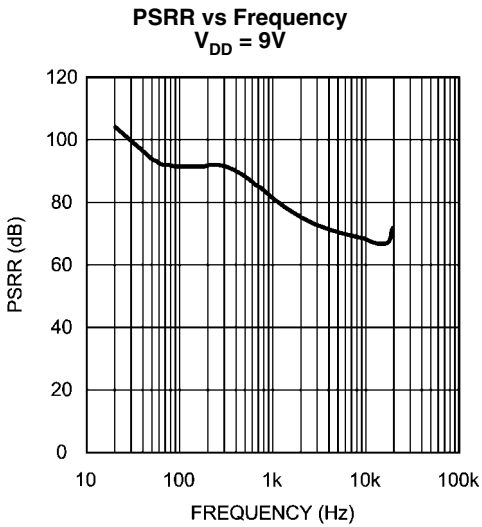

20119644

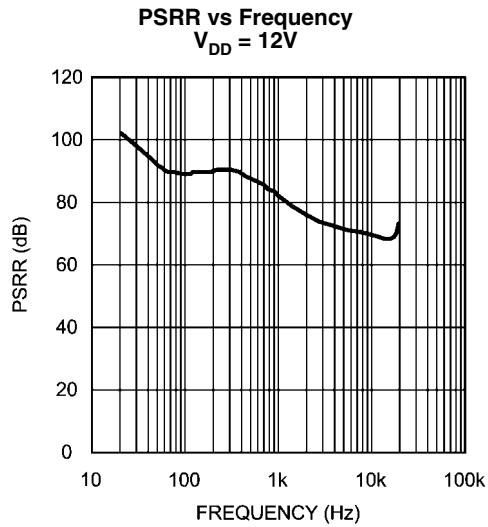

20119645

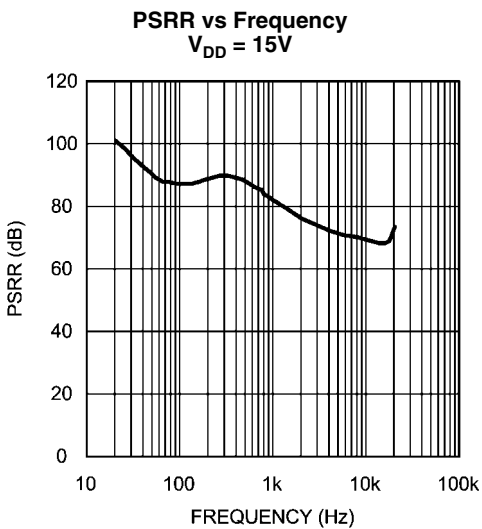

20119646

Class-D Amplifier Dissipation vs Load Dissipation
 Per Channel, $V_{DD} = 9V$, $R_L = 8\Omega$
 (both channels driven and measured)

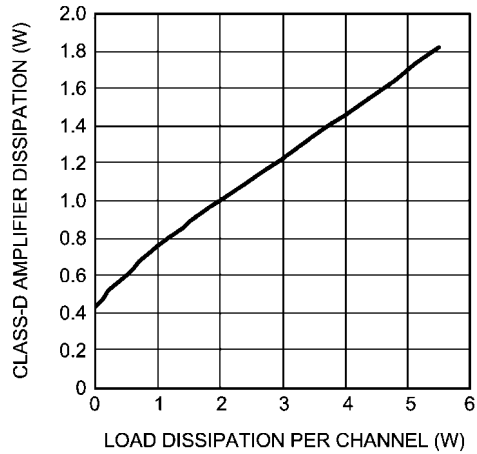

20119638

Class-D Amplifier Dissipation vs Load Dissipation
 Per Channel, $V_{DD} = 12V$, $R_L = 8\Omega$
 (both channels driven and measured)

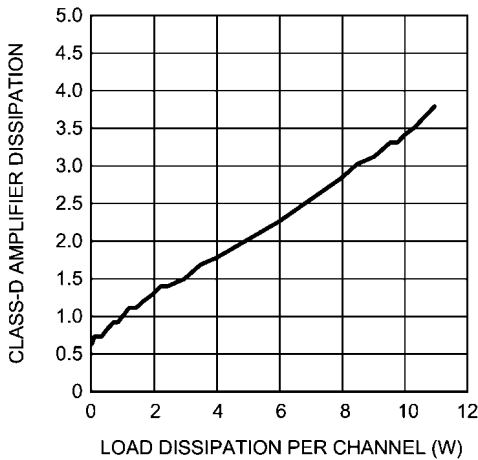

20119639

Class-D Amplifier Dissipation vs Load Dissipation
 Per Channel, $V_{DD} = 15V$, $R_L = 8\Omega$
 (both channels driven and measured)

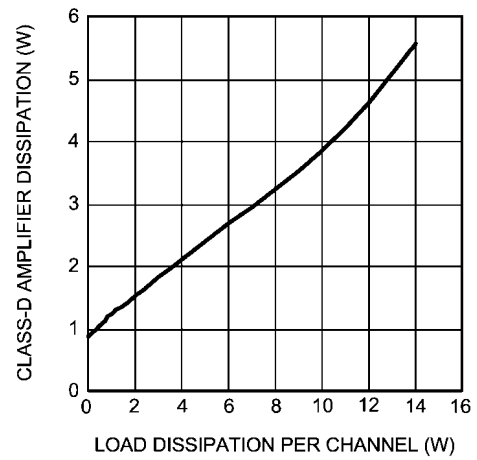

20119640

Efficiency vs Output Power
 $V_{DD} = 9V, R_L = 8\Omega$
 (both channels driven and measured)

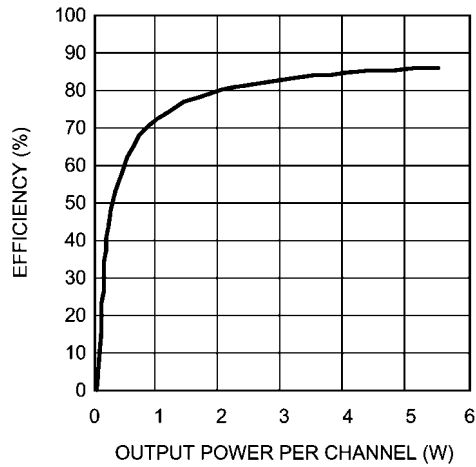

20119641

Efficiency vs Output Power
 $V_{DD} = 12V, R_L = 8\Omega$
 (both channels driven and measured)

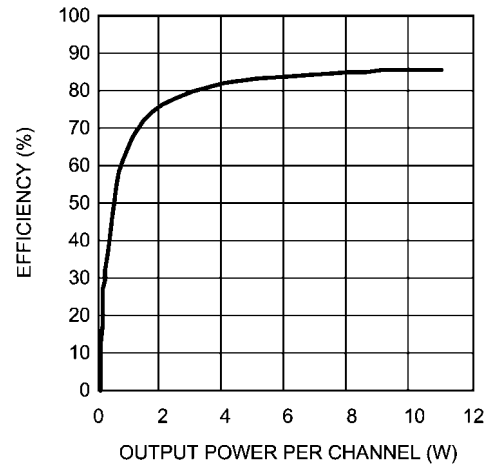

20119642

Efficiency vs Output Power
 $V_{DD} = 15V, R_L = 8\Omega$
 (both channels driven and measured)

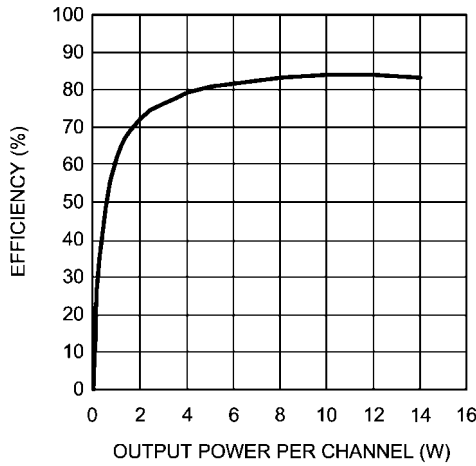

20119643

Output Power vs Load Resistance
 $V_{DD} = 9V, f_{IN} = 1kHz$
 (both channels driven and measured)

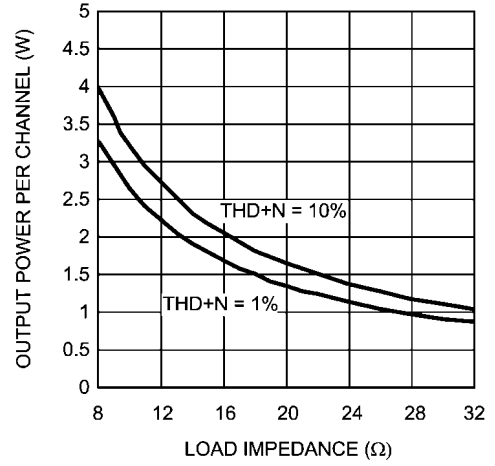

20119655

Output Power vs Load Resistance
 $V_{DD} = 12V, f_{IN} = 1kHz$
 (both channels driven and measured)

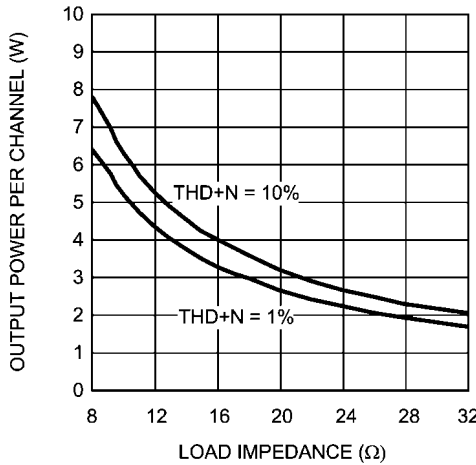

20119656

Output Power vs Load Resistance
 $V_{DD} = 15V, f_{IN} = 1kHz$
 (both channels driven and measured)

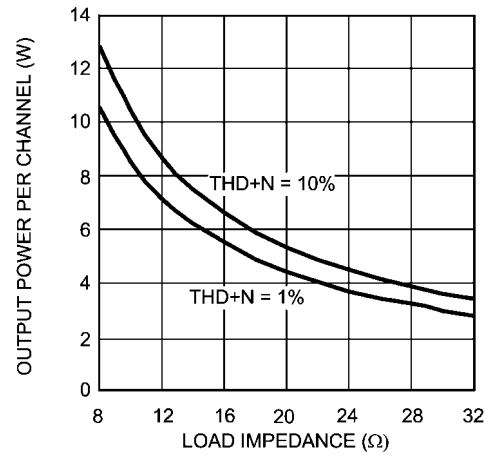

20119657

Power Supply Current vs Power Supply Voltage

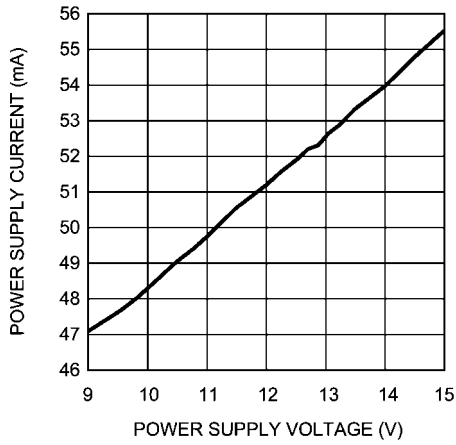

20119654

Class-D Amplifier Gain vs Volume Control Voltage
 $V_{DD} = 15V$

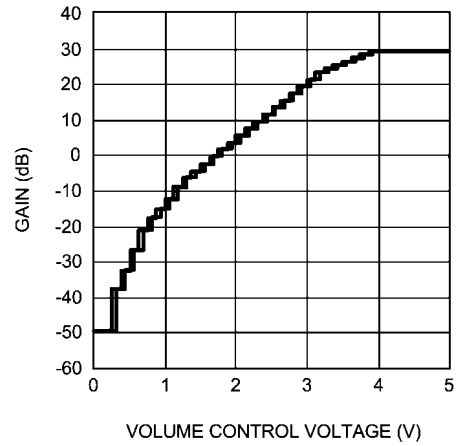

20119628

Typical Performance Characteristics (Headphone Amplifier)

THD+N vs Frequency
 $V_{DD} = 9V, R_L = 32\Omega, P_O = 20mW$

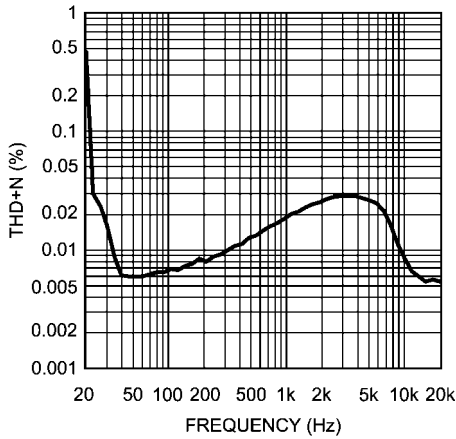

20119651

THD+N vs Frequency
 $V_{DD} = 12V, R_L = 32\Omega, P_O = 20mW$

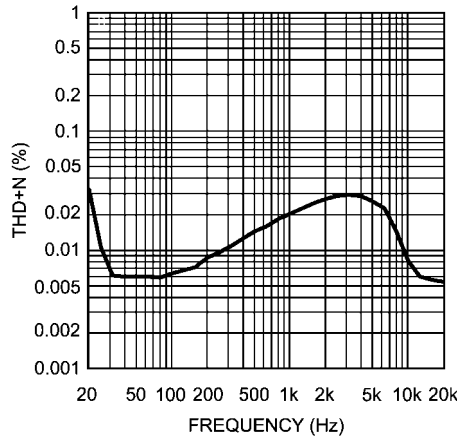

20119652

THD+N vs Frequency
 $V_{DD} = 15V, R_L = 32\Omega, P_O = 20mW$

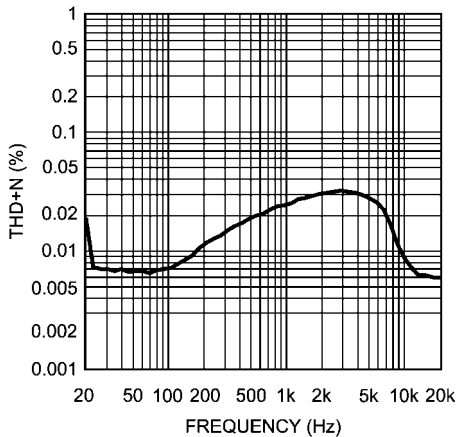

20119653

THD+N vs Output Power
 $V_{DD} = 9V, R_L = 32\Omega, f_{IN} = 1kHz$

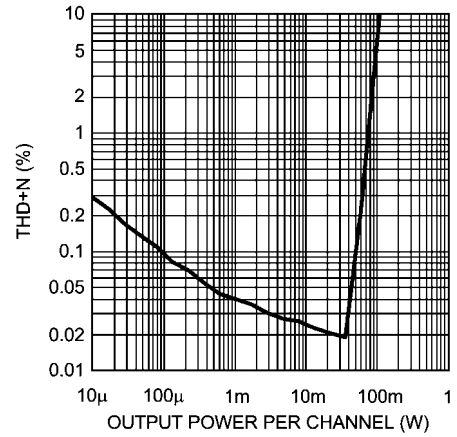

20119668

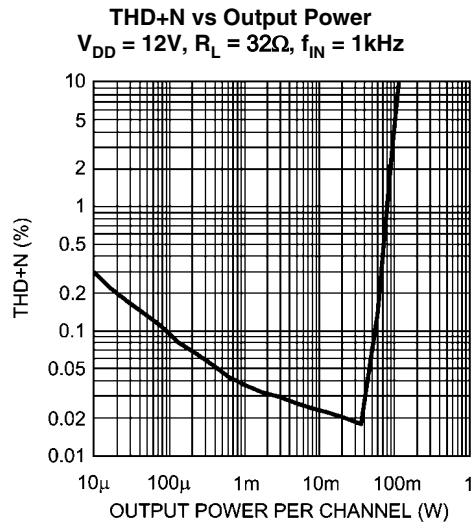

20119669

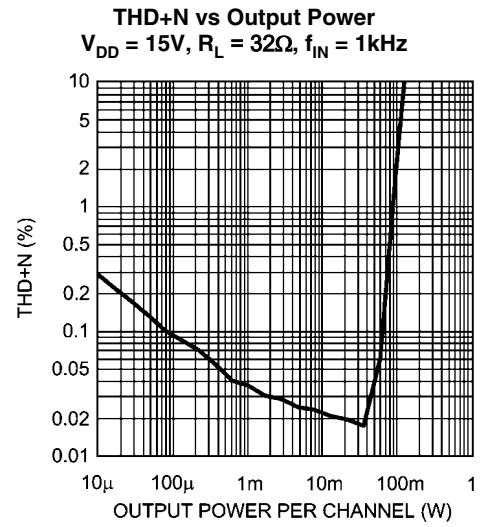

20119670

Output Power vs Supply Voltage Per Channel

$f_{IN} = 1kHz, R_L = 32\Omega$

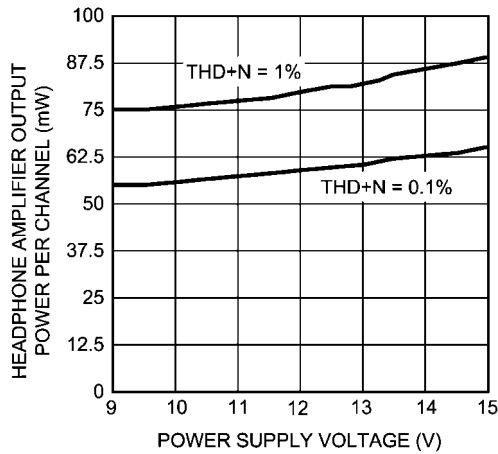

20119671

Power Supply Current vs Power Supply Voltage

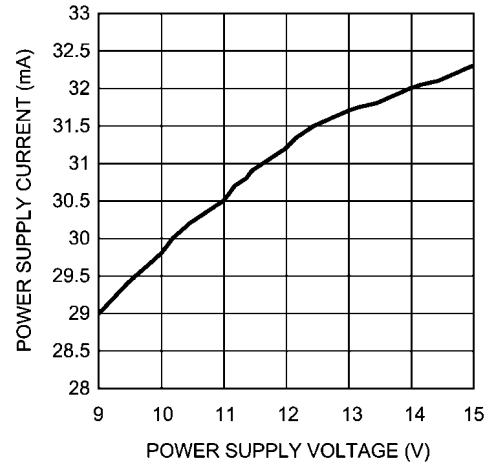

20119650

Headphone Amplifier Gain vs Volume Control Voltage

$V_{DD} = 15V$

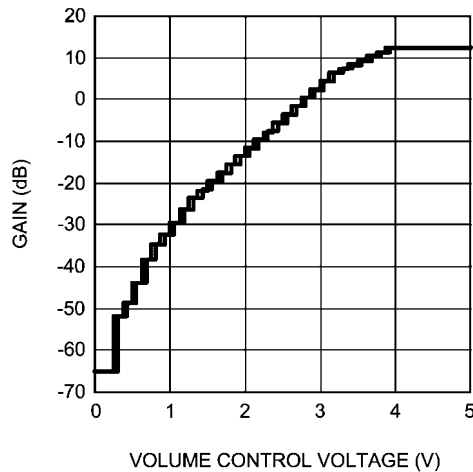

20119629

General Features

SYSTEM FUNCTIONAL INFORMATION

Modulation Technique

Unlike typical Class D amplifiers that use single-ended comparators to generate a pulse-width modulated switching waveform and RC timing circuits to set the switching frequency, the LM4682 uses a balanced differential floating modulator. Oscillation is a result of injecting complimentary currents onto the respective plates of a floating, on-die capacitor. The value of the floating capacitor and value of the components in the modulator's feedback network set the nominal switching frequency at 450kHz. Modulation results from imbalances in the injected currents. The amount of current imbalance is directly proportional to the applied input signal's magnitude and frequency.

Using a balanced, floating modulator produces a Class D amplifier that is immune to common mode noise sources such as substrate noise. This noise occurs because of the high frequency, high current switching in the amplifier's output stage. The LM4682 is immune to this type of noise because the modulator, the components that set its switching frequency, and even the load all float with respect to ground.

The balanced modulator's pulse width modulated output drives the gates of the LM4682's H-bridge configured output power MOSFETs. The pulse-train present at the power MOSFETs' output is applied to an LC low pass filter that removes the 450kHz energy component. The filter's output signal, which is applied to the driven load, is an amplified replica of the audio input signal.

Shutdown Function

The LM4682's active-low shutdown function allows the user to place the amplifier in a shutdown mode while the system power supply remains active. Activating shutdown stops the output switching waveform and minimizes the quiescent current. Applying logic "0" to SDB pin enables the shutdown function. Applying logic "1" to SDB pin disables the shutdown function and restores full amplifier operation.

Mute Function

The LM4682's active-low mute function allows the user to place the amplifier outputs in muted mode while the amplifier's analog input signals remain active. Activating mute internally removes the analog input signal from the Class D and headphone amplifier inputs. While muted the amplifier inputs and outputs retain in their $V_{DD}/2$ operational bias. Applying logic "0" to MUTE pin activates mute. Applying logic "1" to MUTE pin deactivates mute. The MUTE pin is pull-down internally to put both Class D and headphone amplifier outputs mute.

Stereo Headphone Amplifier

The LM4682's stereo headphone amplifier operates continuously, even while the Class D amplifiers are active. When using headphones to listen to program material, it is usually desirable to stop driving external speakers. This is easily achieved by using the active high HPSEL input. As shown in typical application schematic in Figure 1, with no headphones connected to the headphone jack, the input voltage applied to the HPSEL pin is a logic low. In this state, the Class D amplifiers are active and able to drive external speakers. When headphones are plugged into the headphone jack, the switch inside the jack is opened. This changes the voltage applied to the HPSEL pin to a logic high, shutting off the LM4682's

Class D amplifiers. The headphone control of the output configuration is shown in Table 1.

TABLE 1. Headphone Controls

HP Sense Pin, HPSEL	Output Stage Configuration
0	Class D Amps Active
1	Class D Amps Inactive

Under Voltage Protection

The under voltage protection disables the output driver section of the LM4682 while the supply voltage is below 8V. This condition may occur as power is first applied or during low line conditions, changes in load resistance, or when power supply sag occurs. The under voltage protection ensures that all of the LM4682's power MOSFETs are off. This action eliminates shoot-through current and minimizes output transients during turn-on and turn-off. The under voltage protection gives the digital logic time to stabilize into known states, further minimizing turn on output transients.

Power Supply Sequencing

In order to stabilize LM4682 before any operation, a power-up sequence for the power supplies is recommended. The Power V_{DD} should be applied first. Without deactivating the mute and shutdown function of the amplifiers, the $VOLV_{DD}$ is then applied. Prior to removing the two supply voltages, activate shutdown and mute.

Turn-On Time

The LM4682 has an internal timer that determines the amplifier's turn-on time. After power is first applied or the part returns from shutdown, the nominal turn-on time is 600ms. This delay allows all externally applied capacitors to charge to a final value of $V_{DD}/2$. Further, during turn-on, the outputs are muted. This minimizes output transients that may occur while the part settles into its quiescent operating mode.

Output Stage Current Limit and Fault Detection Protection

The output stage MOSFETs are protected against output conditions that could otherwise compromise their operational status. The first stage of protection is output current limiting. When conditions that require high currents to drive a load, the LM4682's current limit circuitry clamps the output current at a nominal value of 2.5A. The output waveform is present, but may be clipped or its amplitude reduced. The same 2.5A nominal current limit also occurs if the amplifier outputs are shorted together or either output is shorted to V_{DD} or GND.

The second stage of protection is an onboard fault detection circuit that continuously monitors the signal on each output MOSFET's gate and compares it against the respective drain voltage. When a condition is detected that violates a MOSFET's Safe Operating Area (SOA) and the drive signal is disconnected from the output MOSFETs' gates. The fault detect circuit maintains this protective condition for approximately 600ms, at which time the drive signal is reconnected. If the fault condition is no longer present, normal operation resumes. If the fault condition remains, however, the drive signal is again disconnected.

Thermal Protection

The LM4682 has thermal shutdown circuitry that monitors the die temperature. Once the LM4682 die temperature reaches 170°C, the LM4682 disables the output switching waveform and remains disabled until the die temperature falls below 140°C (typ).

Over-Modulation Protection

The LM4682's over-modulation protection is a result of the preamplifier's inability to produce signal magnitudes that equal the power supply voltages. Since the preamplifier's output magnitude will always be less than the supply voltage, the duty cycle of the amplifier's switching output will never reach zero. Peak modulation is limited to a nominal 95%.

DC Volume Control

The LM4682 has an internal stereo volume control whose setting is a function of the DC voltage applied to the volume control pin VOLCTL.

The LM4682 volume control consists of 31 steps, which are individually selected by a variable DC voltage level on the VOLCTL pin. A linear type 100k Ω potentiometer is used to adjust the VOLCTL voltage in the LM4682 demonstration board as shown in application circuit (see Figure 1). The resistance value of potentiometer fall in the range from 10k Ω to

100k Ω is recommended to be used with only small amount of current dissipation and large enough for the VOLCTL pin to function properly. The Volume Control Characteristics of LM4682 can be found in the Typical Performance Characteristics section. The gain range of Class D amplifiers are from -48dB to 30dB. The gain range of headphone amplifiers are from -65dB to 13dB. Each gain step corresponds to specific input voltage of both Class D amplifiers and headphone amplifiers are shown in Table 2.

To minimize the effect of noise on the volume control VOLCTL pin, which can affect the selected gain level, hysteresis has been implemented. The amount of hysteresis corresponds to half of the step width. For highest accuracy, the voltage shown in the "recommended voltage" column of the table is used to select a desired gain. The recommended voltage is exactly halfway between the two closest transitions to the next highest or next lowest gain levels.

TABLE 2. Volume Control Table

Step	Voltage Range (% of VOLVDD)			Voltage Range (V), VOLVDD = 5V			Gain (dB)	
	Low	High	Recommended	Low	High	Recommended	Class D Amplifier	Headphone Amplifier
1	77.50%	100.00%	100.000%	3.875	5.000	5.000	29.97	13.06
2	75.00%	78.50%	76.875%	3.750	3.925	3.844	28.97	12.07
3	72.50%	76.25%	74.375%	3.625	3.813	3.719	27.97	11.07
4	70.00%	73.75%	71.875%	3.500	3.688	3.594	26.96	10.06
5	67.50%	71.25%	69.375%	3.375	3.563	3.469	25.98	9.07
6	65.00%	68.75%	66.875%	3.250	3.438	3.344	24.97	8.07
7	62.50%	66.25%	64.375%	3.125	3.313	3.219	23.95	7.05
8	60.00%	63.75%	61.875%	3.000	3.188	3.094	21.98	5.08
9	57.50%	61.25%	59.375%	2.875	3.063	2.969	19.95	3.05
10	55.00%	58.75%	56.785%	2.750	2.983	2.844	17.96	1.06
11	52.50%	56.25%	54.375%	2.625	2.813	2.719	15.97	-0.93
12	50.00%	53.75%	51.875%	2.500	2.688	2.594	13.99	-2.91
13	47.50%	51.25%	49.375%	2.375	2.563	2.469	11.99	-4.91
14	45.00%	48.75%	46.875%	2.250	2.438	2.344	9.95	-6.96
15	42.50%	46.25%	44.375%	2.125	2.313	2.219	7.96	-8.94
16	40.00%	43.75%	41.875%	2.000	2.188	2.094	5.96	-10.95
17	37.50%	41.25%	39.375%	1.875	2.063	1.969	3.99	-12.91
18	35.00%	38.75%	36.875%	1.750	1.938	1.844	2.03	-14.87
19	32.50%	36.25%	34.375%	1.625	1.813	1.719	-0.02	-16.92
20	30.00%	33.75%	31.875%	1.500	1.688	1.594	-2.11	-19.02
21	27.50%	31.25%	29.375%	1.375	1.563	1.469	-4.16	-21.06
22	25.00%	28.75%	26.875%	1.250	1.438	1.344	-5.97	-22.87
23	22.50%	26.25%	24.375%	1.125	1.313	1.219	-8.77	-25.68
24	20.00%	23.75%	21.875%	1.000	1.188	1.094	-12.06	-28.96
25	17.50%	21.25%	19.375%	0.875	1.063	0.969	-14.84	-31.75
26	15.00%	18.75%	16.875%	0.750	0.938	0.844	-17.36	-34.26
27	12.50%	16.25%	14.375%	0.625	0.813	0.719	-20.89	-37.79
28	10.00%	13.75%	11.875%	0.500	0.688	0.594	-26.92	-43.83
29	7.50%	11.25%	9.375%	0.375	0.563	0.469	-32.95	-49.85
30	5.00%	8.75%	6.875%	0.250	0.438	0.344	-38.97	-55.88
31	0.00%	6.25%	0.000%	0.000	0.313	0.000	-48.03	-64.94

Application Hints

SUPPLY BYPASSING

The major source of noises to be taken care and applying bypassing technique in using LM4682 are those transients response coming from its output stage. During the switching operations of the output stage of LM4682, the switching frequencies vary when the internal modulator react to the input signals. This creates a band of switching transients giving back to the power supply terminals of LM4682. A single capacitor may not bypass those transients well. Two capacitors which values are closed to each other are used to bypass this range of frequencies to the ground. 10 μ F tantalum capacitors and 4.7 μ F ceramic capacitors are needed for this kind of decoupling of LM4682 switching operation. This results an improvement in terms of both stability and audio performance of LM4682. In addition, these capacitors should be placed as close as possible to each IC's supply pin(s) using leads as short as possible. Apart from the power supply de-coupling capacitors, the four bootstrapping capacitors (at pins BST1_A, BST2_A, BST1_B and BST2_B) should also be placed close to their corresponding pins. This could minimize the undesirable switching noise coupled to the supply rail.

The LM4682 has two different sets of V_{DD} pins: a set for power V_{DD} (P V_{DD_A} and P V_{DD_B}) and a set for signal V_{DD_A} and HP_ V_{DD} . The parallel combination of the low value ceramic (4.7 μ F) and high value tantalum (10 μ F) should be used to bypass the power V_{DD} pins. A small value (1 μ F) ceramic or tantalum can be used to bypass the signal V_{DD_A} and HP_ V_{DD} pin.

OUTPUT STAGE FILTERING

The LM4682 requires a low pass filter connected between the amplifier's bridge output and the load. Figure 1 shows the recommended LC filter. A minimum value of 22 μ H is recommended. As shown in Figure 1, using the values of the components connected between the amplifier BTL outputs and the load achieves a 2nd-order lowpass filter response which optimizes the amplifier's performance within the audio band.

THD+N MEASUREMENTS AND OUT OF AUDIO BAND NOISE

THD+N (Total Harmonic Distortion plus Noise) is a very important parameter by which all audio amplifiers are measured.

Often it is shown as a graph where either the output power or frequency is changed over the operating range. A very important variable in the measurement of THD+N is the bandwidth-limiting filter at the input of the test equipment. Class D amplifiers, by design, switch their output power devices at a much higher frequency than the accepted audio range (20Hz - 20kHz). Alternately switching the output voltage between V_{DD} and GND allows the LM4682 to operate at much higher efficiency than that achieved by traditional Class AB amplifiers. Switching the outputs at high frequency also increases the out-of-band noise. Under normal circumstances the output lowpass filter significantly reduces this out-of-band noise. If the low pass filter is not optimized for a given switching frequency, there can be significant increase in out-of-band noise. THD+N measurements can be significantly affected by out-of-band noise, resulting in a higher than expected THD+N measurement. To achieve a more accurate measurement of THD, the test equipment's input bandwidth of the must be limited. Some common upper filter points are 22kHz, 30kHz, and 80kHz. The input filter limits the noise component of the THD+N measurement to a smaller bandwidth resulting in a more real-world THD+N value.

RECOMMENDED PRINTED CIRCUIT BOARD LAYOUT

Figures 2 through 6 show the recommended four-layer PCB board layout that is optimized for the 48-pin LLP packaged LM4682 and associated external components. This circuit is designed for use with an external 12V supply and 8 Ω speakers (or load resistors). Apply 12V and ground to board's V_{DD} and GND terminals respectively. And apply 5V to the VOL V_{DD} (refer to power supply sequencing for details). Connect speakers (or load resistors) between the board's OUTA+ and OUTA-, and between the board's OUTB+ and OUTB-. Apply the stereo input signals to IN_A and IN_B. When designing the layout of the PCB layout, please pay attention to the output terminals of LM4682.

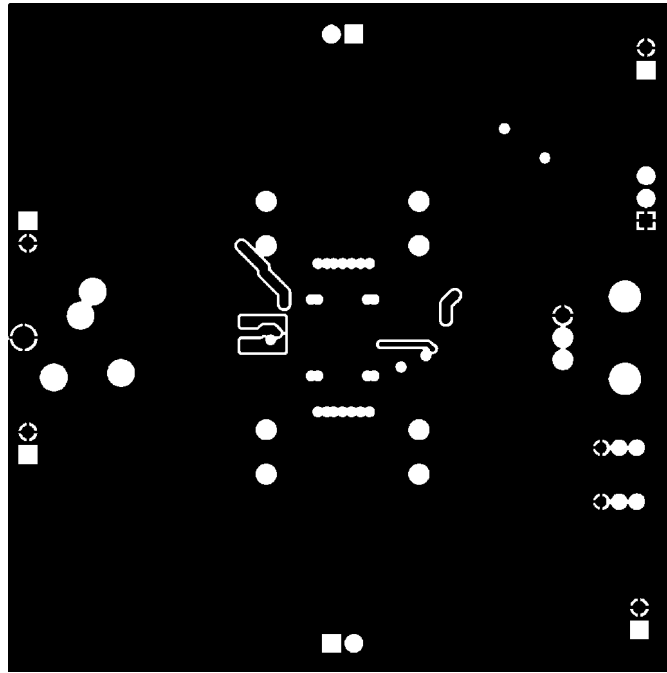

20119623

FIGURE 4. Upper Middle Layer

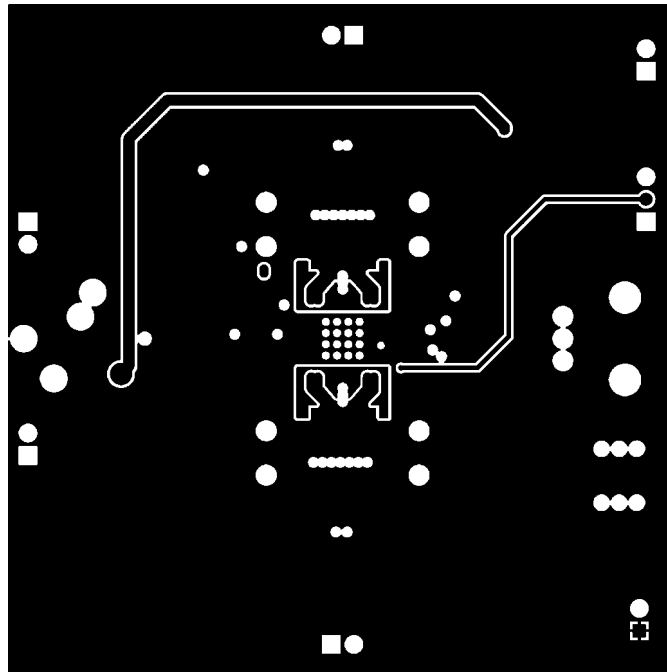

20119624

FIGURE 5. Lower Middle Layer

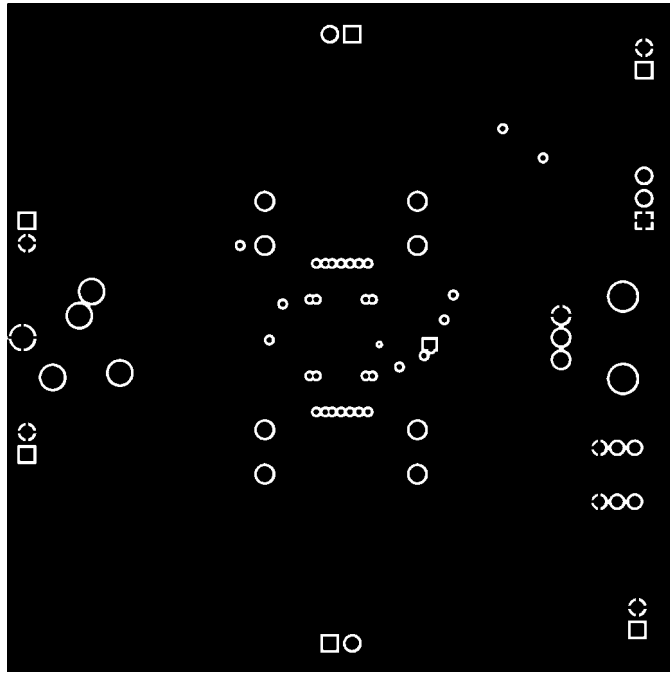

20119625

FIGURE 6. Bottom Layer

Revision History

Rev	Date	Description
1.0	02/22/06	Initial WEB release of the document.
1.1	02/24/06	Edited art 201196 71 (changed the y-axis unit from mA to mW.
1.2	03/08/06	Did few texts clean-up and re-released D/S to the WEB (per Kevin H.).
1.3	06/29/06	Added 2 columns on (Gain dB) Table 2 and re-released the D/S to the WEB (per Alex CK Wong).
1.4	04/09/08	Added volume control curves and input some text edits.
1.5	04/15/08	Changed the titles on curves 20119628 and 29.
1.6	04/21/08	Text edits.

Notes

For more National Semiconductor product information and proven design tools, visit the following Web sites at:

Products		Design Support	
Amplifiers	www.national.com/amplifiers	WEBENCH	www.national.com/webench
Audio	www.national.com/audio	Analog University	www.national.com/AU
Clock Conditioners	www.national.com/timing	App Notes	www.national.com/appnotes
Data Converters	www.national.com/adc	Distributors	www.national.com/contacts
Displays	www.national.com/displays	Green Compliance	www.national.com/quality/green
Ethernet	www.national.com/ethernet	Packaging	www.national.com/packaging
Interface	www.national.com/interface	Quality and Reliability	www.national.com/quality
LVDS	www.national.com/lvds	Reference Designs	www.national.com/refdesigns
Power Management	www.national.com/power	Feedback	www.national.com/feedback
Switching Regulators	www.national.com/switchers		
LDOs	www.national.com/ldo		
LED Lighting	www.national.com/led		
PowerWise	www.national.com/powerwise		
Serial Digital Interface (SDI)	www.national.com/sdi		
Temperature Sensors	www.national.com/tempsensors		
Wireless (PLL/VCO)	www.national.com/wireless		

THE CONTENTS OF THIS DOCUMENT ARE PROVIDED IN CONNECTION WITH NATIONAL SEMICONDUCTOR CORPORATION ("NATIONAL") PRODUCTS. NATIONAL MAKES NO REPRESENTATIONS OR WARRANTIES WITH RESPECT TO THE ACCURACY OR COMPLETENESS OF THE CONTENTS OF THIS PUBLICATION AND RESERVES THE RIGHT TO MAKE CHANGES TO SPECIFICATIONS AND PRODUCT DESCRIPTIONS AT ANY TIME WITHOUT NOTICE. NO LICENSE, WHETHER EXPRESS, IMPLIED, ARISING BY ESTOPPEL OR OTHERWISE, TO ANY INTELLECTUAL PROPERTY RIGHTS IS GRANTED BY THIS DOCUMENT.

TESTING AND OTHER QUALITY CONTROLS ARE USED TO THE EXTENT NATIONAL DEEMS NECESSARY TO SUPPORT NATIONAL'S PRODUCT WARRANTY. EXCEPT WHERE MANDATED BY GOVERNMENT REQUIREMENTS, TESTING OF ALL PARAMETERS OF EACH PRODUCT IS NOT NECESSARILY PERFORMED. NATIONAL ASSUMES NO LIABILITY FOR APPLICATIONS ASSISTANCE OR BUYER PRODUCT DESIGN. BUYERS ARE RESPONSIBLE FOR THEIR PRODUCTS AND APPLICATIONS USING NATIONAL COMPONENTS. PRIOR TO USING OR DISTRIBUTING ANY PRODUCTS THAT INCLUDE NATIONAL COMPONENTS, BUYERS SHOULD PROVIDE ADEQUATE DESIGN, TESTING AND OPERATING SAFEGUARDS.

EXCEPT AS PROVIDED IN NATIONAL'S TERMS AND CONDITIONS OF SALE FOR SUCH PRODUCTS, NATIONAL ASSUMES NO LIABILITY WHATSOEVER, AND NATIONAL DISCLAIMS ANY EXPRESS OR IMPLIED WARRANTY RELATING TO THE SALE AND/OR USE OF NATIONAL PRODUCTS INCLUDING LIABILITY OR WARRANTIES RELATING TO FITNESS FOR A PARTICULAR PURPOSE, MERCHANTABILITY, OR INFRINGEMENT OF ANY PATENT, COPYRIGHT OR OTHER INTELLECTUAL PROPERTY RIGHT.

LIFE SUPPORT POLICY

NATIONAL'S PRODUCTS ARE NOT AUTHORIZED FOR USE AS CRITICAL COMPONENTS IN LIFE SUPPORT DEVICES OR SYSTEMS WITHOUT THE EXPRESS PRIOR WRITTEN APPROVAL OF THE CHIEF EXECUTIVE OFFICER AND GENERAL COUNSEL OF NATIONAL SEMICONDUCTOR CORPORATION. As used herein:

Life support devices or systems are devices which (a) are intended for surgical implant into the body, or (b) support or sustain life and whose failure to perform when properly used in accordance with instructions for use provided in the labeling can be reasonably expected to result in a significant injury to the user. A critical component is any component in a life support device or system whose failure to perform can be reasonably expected to cause the failure of the life support device or system or to affect its safety or effectiveness.

National Semiconductor and the National Semiconductor logo are registered trademarks of National Semiconductor Corporation. All other brand or product names may be trademarks or registered trademarks of their respective holders.

Copyright© 2008 National Semiconductor Corporation

For the most current product information visit us at www.national.com



**National Semiconductor
Americas Technical
Support Center**
Email:
new.feedback@nsc.com
Tel: 1-800-272-9959

**National Semiconductor Europe
Technical Support Center**
Email: europe.support@nsc.com
German Tel: +49 (0) 180 5010 771
English Tel: +44 (0) 870 850 4288

**National Semiconductor Asia
Pacific Technical Support Center**
Email: ap.support@nsc.com

**National Semiconductor Japan
Technical Support Center**
Email: jpn.feedback@nsc.com