

LM4888 Boomer® Audio Power Amplifier Series

Dual 2.1W Audio Amplifier Plus Stereo Headphone & 3D Enhancement

General Description

The LM4888 is a dual bridge-connected audio power amplifier which, when connected to a 5V supply, will deliver 2.1W to a 4Ω load (Note 1) or 2.4W to a 3Ω load (Note 2) with less than 1.0% THD+N.

A user selectable “National 3D Enhancement” mode provides enhanced stereo imaging.

The LM4888SQ also has two separate HP (headphone) enable inputs, each having different logic level thresholds. Either HP enable input activates the single ended headphone mode and disables the BTL output mode. The HP Sense input is for use with a normal stereo headphone jack. The remaining input, HP Logic, accepts standard logic level thresholds.

Boomer audio power amplifiers were designed specifically to provide high quality output power from a surface mount package while requiring few external components. To simplify audio system design, the LM4888SQ combines dual bridge speaker amplifiers and stereo headphone amplifiers on one chip.

The LM4888SQ features a low-power consumption shutdown mode and thermal shutdown protection. It also utilizes circuitry to reduce “clicks and pops” during device turn-on.

Note 1: An LM4888SQ that has been properly mounted to a circuit board will deliver 2.1W into 4Ω. See the Application Information sections for further information concerning the LM4888SQ.

Note 2: An LM4888SQ that has been properly mounted to a circuit board and forced-air cooled will deliver 2.4W into 3Ω.

Key Specifications

■ P _O at 1% THD+N, V _{DD} = 5V	
R _L = 3Ω	2.4W (typ)
R _L = 4Ω	2.1W (typ)
R _L = 8Ω	1.3W (typ)
■ Single-ended mode THD+N at 75mW into 32Ω (5V, 1kHz)	0.01% (typ)
■ Shutdown current	0.04μA (typ)
■ Supply voltage range	2.7V to 5.5V
■ PSRR at 217Hz	85dB (typ)

Features

- National 3D Enhancement
- Selectable headphone enable modes
- Stereo headphone amplifier mode
- Improved “click and pop” suppression circuitry
- Thermal shutdown protection circuitry
- PCB area-saving SQ package
- Micro power shutdown mode

Applications

- Cell phones
- Multimedia monitors
- Portable and desktop computers
- Portable audio systems

Connection Diagrams

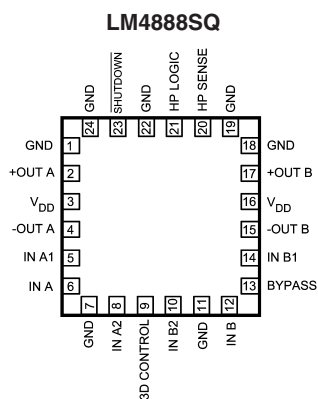

Top View
Order Number LM4888SQ
See NS Package Number SQA24A

LM4888SQ Top Mark

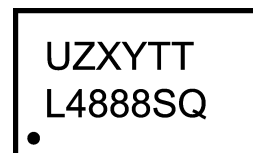

Top View
U = Fab Code
Z = Assembly Plant Code
XY = Date Code
TT = Die Traceability

Boomer® is a registered trademark of National Semiconductor Corporation.

Typical Application

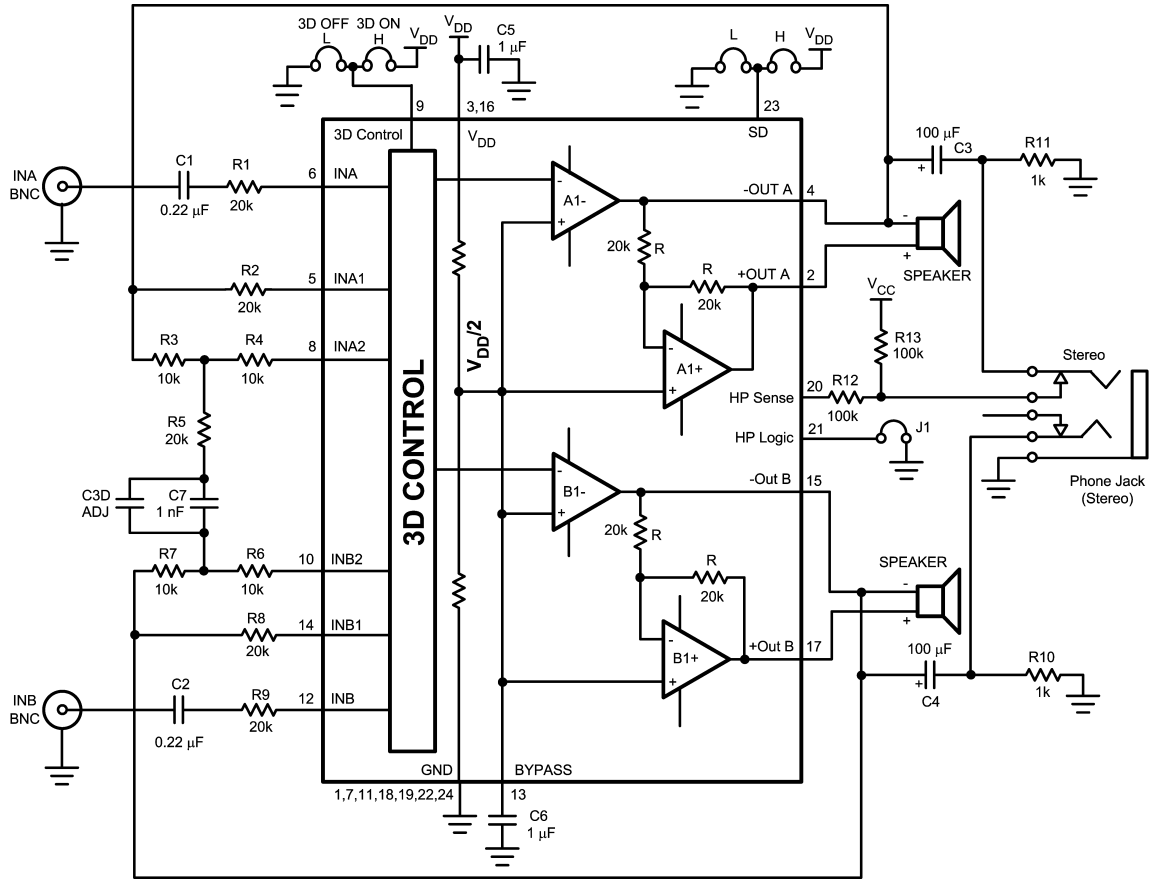

20111629

FIGURE 1. Typical Audio Amplifier Application Circuit

Absolute Maximum Ratings (Note 3)

If Military/Aerospace specified devices are required, please contact the National Semiconductor Sales Office/Distributors for availability and specifications.

Supply Voltage	6.0V
Storage Temperature	-65°C to +150°C
Input Voltage	-0.3V to $V_{DD} + 0.3V$
Power Dissipation (Note 4)	Internally limited
ESD Susceptibility (Note 5)	2000V
ESD Susceptibility (Note 6)	200V
Junction Temperature	150°C
Solder Information	

Small Outline Package

Vapor Phase (60 sec.)

215°C

Infrared (15 sec.)

220°C

Thermal Resistance

 θ_{JC} (typ)—SQA24B

3°C/W

 θ_{JA} (typ)—SQA24B

42°C/W

Operating Ratings

Temperature Range

 $T_{MIN} \leq T_A \leq T_{MAX}$ -40°C $\leq T_A \leq$ 85°C

Supply Voltage

2.7V $\leq V_{DD} \leq$ 5.5V**Electrical Characteristics (5V)** (Notes 3, 7, 13)The following specifications apply for $V_{DD} = 5V$ unless otherwise noted. Limits apply for $T_A = 25^\circ C$.

Symbol	Parameter	Conditions	LM4888		Units (Limits)
			Typical (Note 8)	Limit (Note 9)	
V_{DD}	Supply Voltage			2.7	V (min)
				5.5	V (max)
I_{DD}	Quiescent Power Supply Current	$V_{IN} = 0V, I_O = 0A$ (Note 10), BTL mode	6	10	mA (max)
		$V_{IN} = 0V, I_O = 0A$ (Note 10), SE mode	3.0	6	mA (max)
I_{SD}	Shutdown Current	GND applied to the SHUTDOWN pin	0.04	2	μA (max)
V_{IH}	Headphone Sense High Input Voltage		3.7	4	V (min)
V_{IL}	Headphone Sense Low Input Voltage		2.6	0.8	V (max)
V_{IHSD}	Shutdown, Headphone micro, 3D control High Input voltage		1.2	1.4	V (min)
V_{ILSD}	Shutdown, Headphone micro, 3D control Low Input voltage		1	0.4	V (max)
T_{WU}	Turn On Time	1 μF Bypass Cap (C6)	140		ms

Electrical Characteristics for Bridged-Mode Operation (5V) (Notes 3, 7, 13)The following specifications apply for $V_{DD} = 5V$ unless otherwise specified. Limits apply for $T_A = 25^\circ C$.

Symbol	Parameter	Conditions	LM4888		Units (Limits)	
			Typical (Note 8)	Limit (Note 9)		
V_{OS}	Output Offset Voltage	$V_{IN} = 0V$	5	25	mV (max)	
P_O	Output Power (Note 11)	THD+N = 1%, f = 1kHz (Note 12)				
		LM4888SQ, $R_L = 3\Omega$	2.4		W	
		LM4888SQ, $R_L = 4\Omega$	2.1		W	
		LM4888SQ, $R_L = 8\Omega$	1.3	1.0	W (min)	
		THD+N = 10%, f = 1kHz (Note 12)				
		LM4888SQ, $R_L = 3\Omega$	3.0		W	
	LM4888SQ, $R_L = 4\Omega$	2.5		W		
	LM4888SQ, $R_L = 8\Omega$	1.7		W		
THD+N	Total Harmonic Distortion+Noise	1kHz, $A_{VD} = 2$				
		LM4888SQ, $R_L = 4\Omega, P_O = 1W$	0.10		%	
		LM4888SQ, $R_L = 8\Omega, P_O = .4W$	0.06		%	

Electrical Characteristics for Bridged-Mode Operation (5V) (Notes 3, 7,

13) (Continued)

The following specifications apply for $V_{DD} = 5V$ unless otherwise specified. Limits apply for $T_A = 25^\circ C$.

Symbol	Parameter	Conditions	LM4888		Units (Limits)
			Typical (Note 8)	Limit (Note 9)	
PSRR	Power Supply Rejection Ratio	Input unterminated, 217Hz $V_{ripple} = 200mV_{p-p}$ $C_6 = 1\mu F, R_L = 8\Omega$	85		dB
		Input unterminated, 1kHz $V_{ripple} = 200mV_{p-p}$ $C_6 = 1\mu F, R_L = 8\Omega$	80		dB
		Input grounded, 217Hz $V_{ripple} = 200mV_{p-p}$ $C_6 = 1\mu F, R_L = 8\Omega$	65		dB
		Input grounded, 1kHz $V_{ripple} = 200mV_{p-p}$ $C_6 = 1\mu F, R_L = 8\Omega$	70		dB
X_{TALK}	Channel Separation	$f = 1kHz, C_6 = 1.0\mu F, 3D \text{ Control} = \text{Low}$	82		dB
V_{NO}	Output Noise Voltage	1kHz, A-weighted	21		μV

Electrical Characteristics for Single-Ended Operation (5V) (Notes 3, 7, 13)The following specifications apply for $V_{DD} = 5V$ unless otherwise specified. Limits apply for $T_A = 25^\circ C$.

Symbol	Parameter	Conditions	LM4888		Units (Limits)
			Typical (Note 8)	Limit (Note 9)	
P_O	Output Power	THD+N = 0.5%, $f = 1 \text{ kHz}, R_L = 32\Omega$	90	75	mW (min)
THD+N	Total Harmonic Distortion+Noise	$P_O = 20mW, 1kHz, R_L = 32\Omega$	0.015		%
PSRR	Power Supply Rejection Ratio	Input unterminated, 217Hz $V_{ripple} = 200mV_{p-p}$ $C_6 = 1\mu F, R_L = 32\Omega$	70		dB
		Input unterminated, 1kHz $V_{ripple} = 200mV_{p-p}$ $C_6 = 1\mu F, R_L = 32\Omega$	72		dB
		Input grounded, 217Hz $V_{ripple} = 200mV_{p-p}$ $C_6 = 1\mu F, R_L = 32\Omega$	65		dB
		Input grounded, 1kHz $V_{ripple} = 200mV_{p-p}$ $C_6 = 1\mu F, R_L = 32\Omega$	70		dB
X_{TALK}	Channel Separation	$f = 1kHz, C_6 = 1.0\mu F, 3D \text{ Control} = \text{Low}$	80		dB
V_{NO}	Output Noise Voltage	1kHz, A-weighted	11		μV

Electrical Characteristics (3V) (Notes 3, 7, 13)

The following specifications apply for $V_{DD} = 3V$ unless otherwise noted. Limits apply for $T_A = 25^\circ C$.

Symbol	Parameter	Conditions	LM4888		Units (Limits)
			Typical (Note 8)	Limit (Note 9)	
I_{DD}	Quiescent Power Supply Current	$V_{IN} = 0V, I_O = 0A$ (Note 10), BTL mode	4.5		mA
		$V_{IN} = 0V, I_O = 0A$ (Note 10), SE mode	2.5		mA
I_{SD}	Shutdown Current	GND applied to the SHUTDOWN pin	0.01		μA
V_{IH}	Headphone High Input Voltage		2.2		V
V_{IL}	Headphone Low Input Voltage		1.5		V
V_{IHSD}	Shutdown, Headphone micro, 3D Control High Input voltage		1	1.4	V (min)
V_{ILSD}	Shutdown, Headphone micro, 3D Control Low Input voltage		0.8	.4	V (max)
T_{WU}	Turn On Time	1 μF Bypass Cap (C6)	140		ms

Electrical Characteristics for Bridged-Mode Operation (3V) (Notes 3, 7, 13)

The following specifications apply for $V_{DD} = 3V$ unless otherwise specified. Limits apply for $T_A = 25^\circ C$.

Symbol	Parameter	Conditions	LM4888		Units (Limits)	
			Typical (Note 8)	Limit (Note 9)		
V_{OS}	Output Offset Voltage	$V_{IN} = 0V$	5		mV	
P_O	Output Power (Note 11)	THD+N = 1%, f = 1kHz (Note 12)				
		LM4888SQ, $R_L = 3\Omega$.82		W	
		LM4888SQ, $R_L = 4\Omega$.70		W	
		LM4888SQ, $R_L = 8\Omega$.43		W	
		THD+N = 10%, f = 1kHz (Note 12)				
		LM4888SQ, $R_L = 3\Omega$	1.0		W	
THD+N	Total Harmonic Distortion+Noise	1kHz				
		LM4888SQ, $R_L = 4\Omega, P_O = 280mW$	0.1		%	
		LM4888SQ, $R_L = 8\Omega, P_O = 200mW$	0.05		%	
PSRR	Power Supply Rejection Ratio	Input unterminated, 217Hz	90		dB	
		$V_{ripple} = 200mV_{p-p}$ $C_6 = 1\mu F, R_L = 8\Omega$				
		Input unterminated, 1kHz	80		dB	
		$V_{ripple} = 200mV_{p-p}$ $C_6 = 1\mu F, R_L = 8\Omega$				
PSRR	Power Supply Rejection Ratio	Input grounded, 217Hz	65		dB	
		$V_{ripple} = 200mV_{p-p}$ $C_6 = 1\mu F, R_L = 8\Omega$				
PSRR	Power Supply Rejection Ratio	Input grounded, 1kHz	73		dB	
		$V_{ripple} = 200mV_{p-p}$ $C_6 = 1\mu F, R_L = 8\Omega$				
X_{TALK}	Channel Separation	f = 1kHz, $C_6 = 1.0\mu F$, 3D Control = Low	85		dB	
V_{NO}	Output Noise Voltage	1kHz, A-weighted	21		μV	

Electrical Characteristics for Single-Ended Operation (3V) (Notes 3, 7, 13)

The following specifications apply for $V_{DD} = 3V$ unless otherwise specified. Limits apply for $T_A = 25^\circ C$.

Symbol	Parameter	Conditions	LM4888		Units (Limits)
			Typical (Note 8)	Limit (Note 9)	
P_O	Output Power	THD+N = 0.5%, $f = 1 \text{ kHz}$, $R_L = 32\Omega$	35		mW
THD+N	Total Harmonic Distortion+Noise	$P_O = 25\text{mW}$, 1kHz , $R_L = 32\Omega$.015		%
PSRR	Power Supply Rejection Ratio	Input unterminated, 217Hz $V_{\text{ripple}} = 200\text{mV}_{\text{p-p}}$ $C_6 = 1\mu\text{F}$, $R_L = 32\Omega$	71		dB
		Input unterminated, 1kHz $V_{\text{ripple}} = 200\text{mV}_{\text{p-p}}$ $C_6 = 1\mu\text{F}$, $R_L = 32\Omega$	79		dB
		Input grounded, 217Hz $V_{\text{ripple}} = 200\text{mV}_{\text{p-p}}$ $C_6 = 1\mu\text{F}$, $R_L = 32\Omega$	65		dB
		Input grounded, 1kHz $V_{\text{ripple}} = 200\text{mV}_{\text{p-p}}$ $C_6 = 1\mu\text{F}$, $R_L = 32\Omega$	72		dB
X_{TALK}	Channel Separation	$f = 1\text{kHz}$, $C_6 = 1.0\mu\text{F}$, 3D Control = Low	80		dB
V_{NO}	Output Noise Voltage	1kHz, A-weighted	11		μV

Note 3: Absolute Maximum Ratings indicate limits beyond which damage to the device may occur. Operating Ratings indicate conditions for which the device is functional, but do not guarantee specific performance limits. Electrical Characteristics state DC and AC electrical specifications under particular test conditions which guarantee specific performance limits. This assumes that the device operates within the Operating Ratings. Specifications are not guaranteed for parameters where no limit is given. The typical value however, is a good indication of device performance.

Note 4: The maximum power dissipation must be derated at elevated temperatures and is dictated by T_{JMAX} , θ_{JA} , and the ambient temperature T_A . The maximum allowable power dissipation is $P_{\text{DMAX}} = (T_{\text{JMAX}} - T_A)/\theta_{\text{JA}}$. For the LM4888SQ, $T_{\text{JMAX}} = 150^\circ C$.

Note 5: Human body model, 100pF discharged through a 1.5k Ω resistor.

Note 6: Machine model, 200pF–220pF discharged through all pins.

Note 7: All voltages are measured with respect to the ground (GND) pins, unless otherwise specified.

Note 8: Typicals are specified at 25 $^\circ C$ and represent the parametric norm.

Note 9: Datasheet min/max specification limits are guaranteed by design, test, or statistical analysis.

Note 10: The quiescent power supply current depends on the offset voltage when a practical load is connected to the amplifier.

Note 11: Output power is measured at the device terminals.

Note 12: When driving 3 Ω or 4 Ω loads and operating on a 5V supply, the LM4888SQ must be mounted to a circuit board that has a minimum of 2.5in² of exposed, uninterrupted copper area connected to the SQ package's exposed DAP.

Note 13: All measurements taken from Applications Diagram (Figure 1).

Typical Performance Characteristics

THD+N vs Output Power
5V, 8Ω, BTL at 1kHz

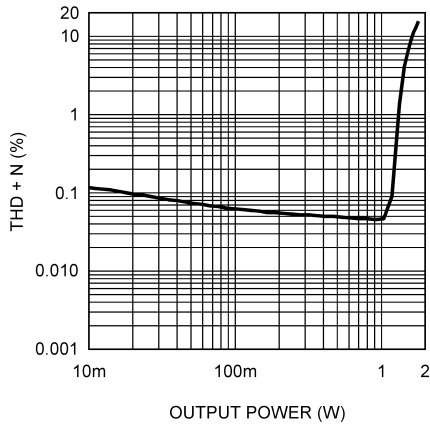

201116B6

THD+N vs Output Power
5V, 4Ω, BTL at 1kHz

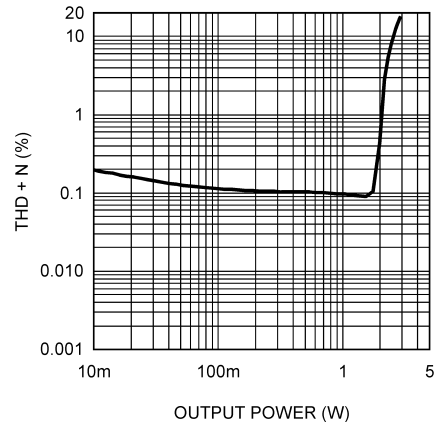

201116B5

THD+N vs Output Power
5V, 3Ω, BTL at 1kHz

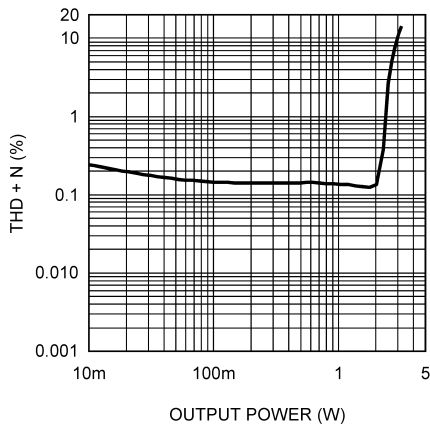

201116B4

THD+N vs Output Power
5V, 32Ω, BTL at 1kHz

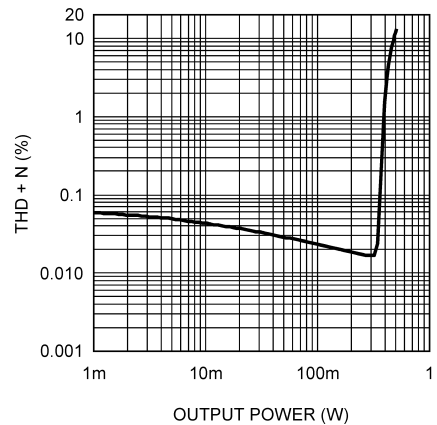

201116B8

THD+N vs Output Power
5V, 32Ω, SE at 1kHz

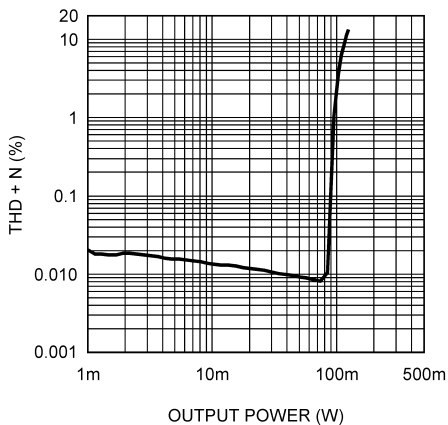

201116B9

THD+N vs Output Power
3V, 8Ω, BTL at 1kHz

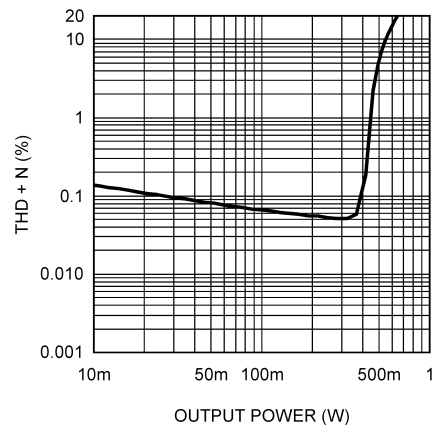

201116B0

Typical Performance Characteristics (Continued)

THD+N vs Output Power
3V, 4Ω, BTL at 1kHz

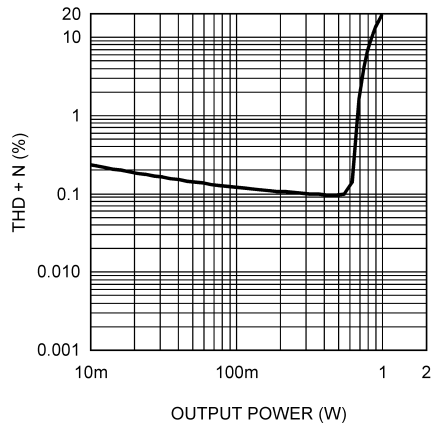

20111679

THD+N vs Output Power
3V, 3Ω, BTL at 1kHz

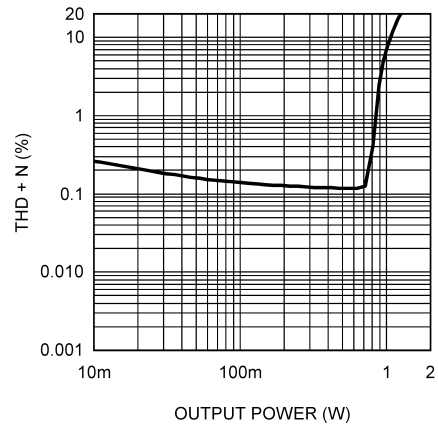

20111678

THD+N vs Output Power
3V, 32Ω, BTL at 1kHz

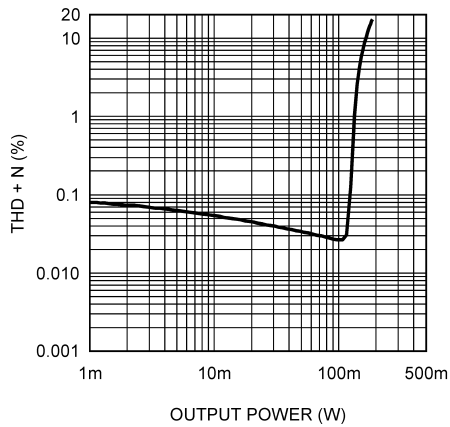

20111682

THD+N vs Output Power
3V, 32Ω, SE at 1kHz

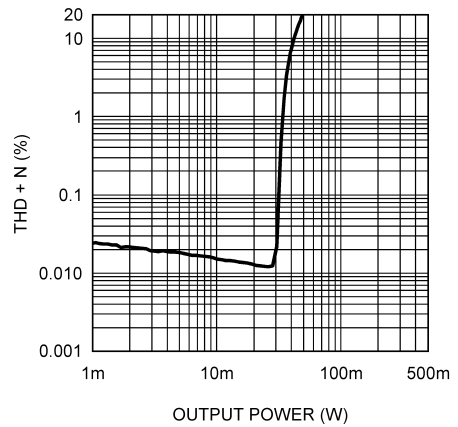

20111683

THD+N vs Frequency
5V, 8Ω, BTL at 400mW

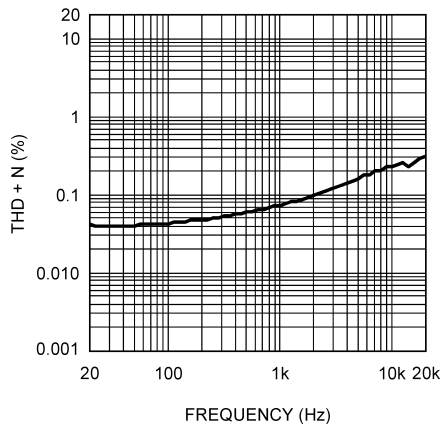

20111676

THD+N vs Frequency
5V, 4Ω, BTL at 1W

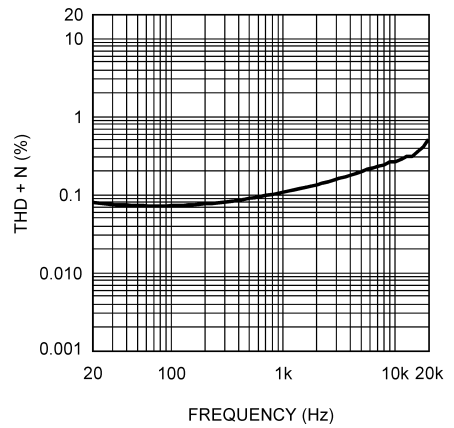

20111675

Typical Performance Characteristics (Continued)

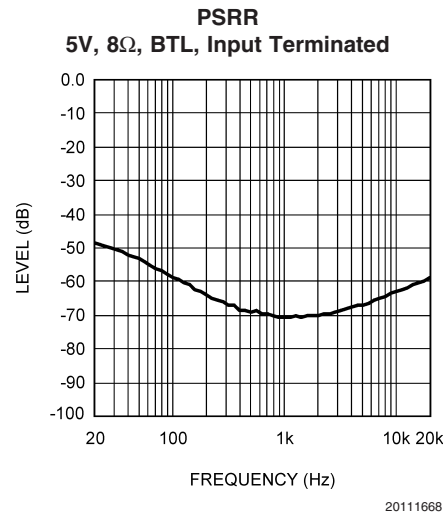
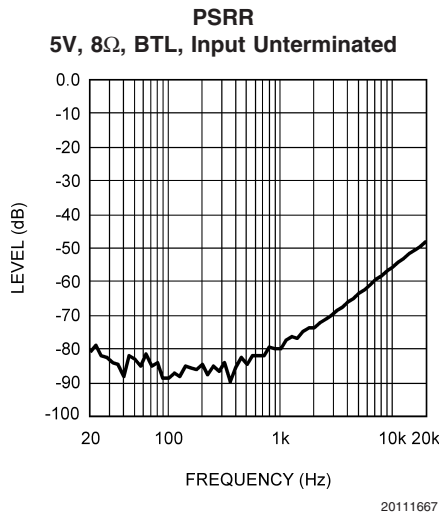
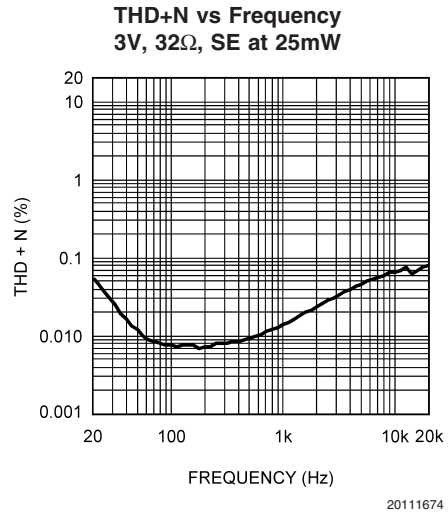
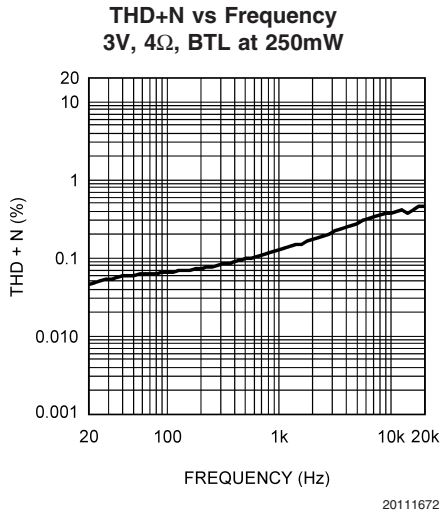
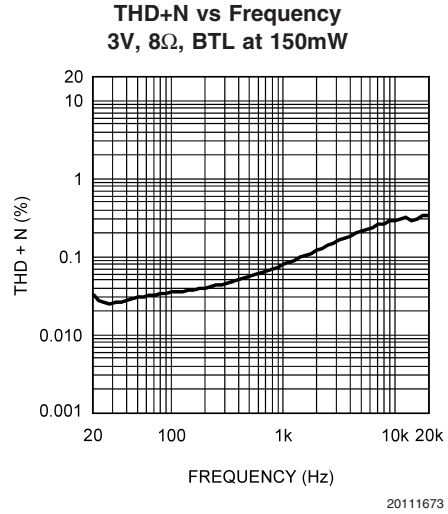
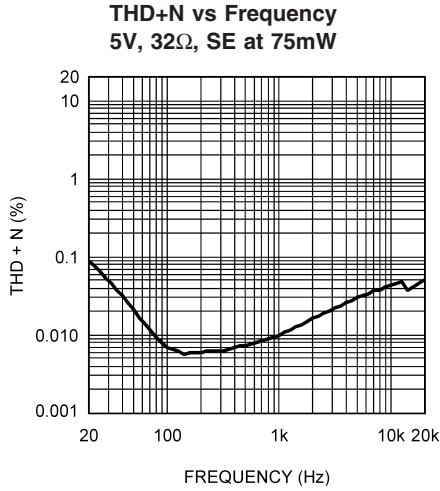

Typical Performance Characteristics (Continued)

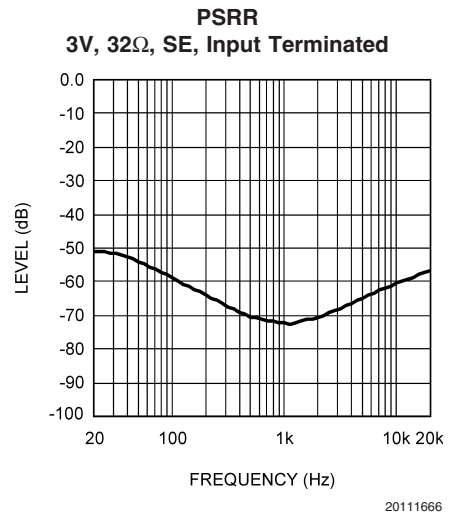
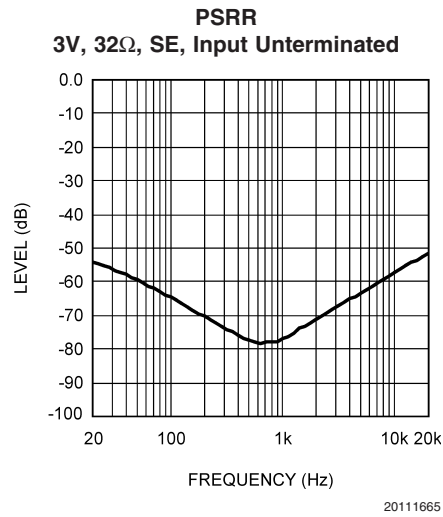
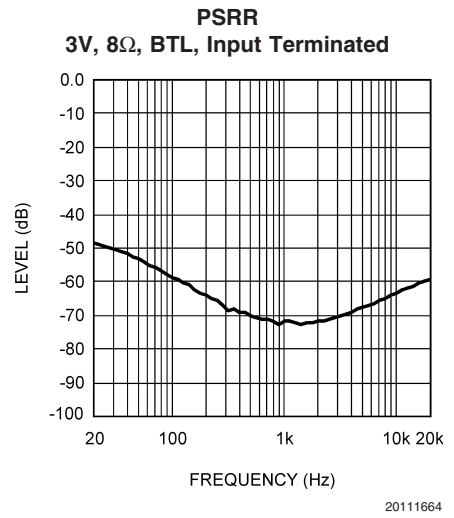
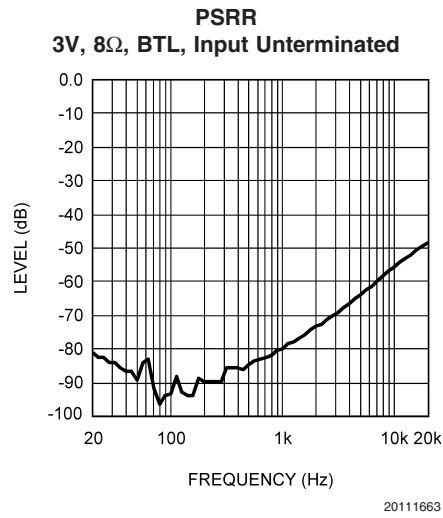
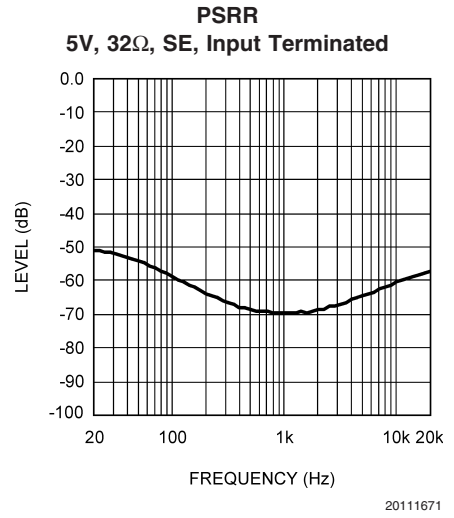
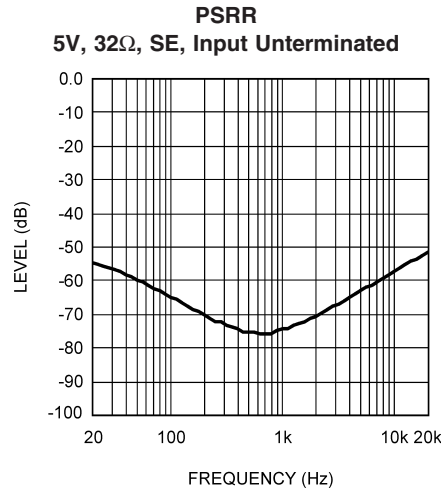

Typical Performance Characteristics (Continued)

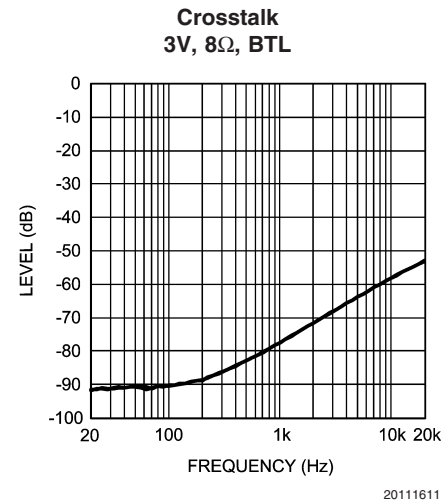
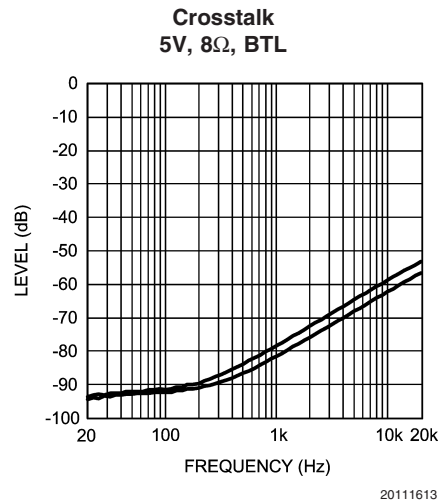
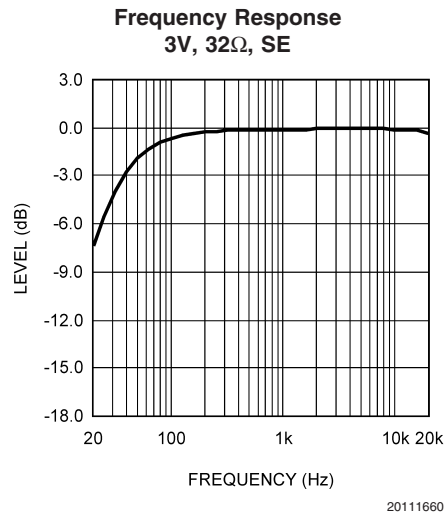
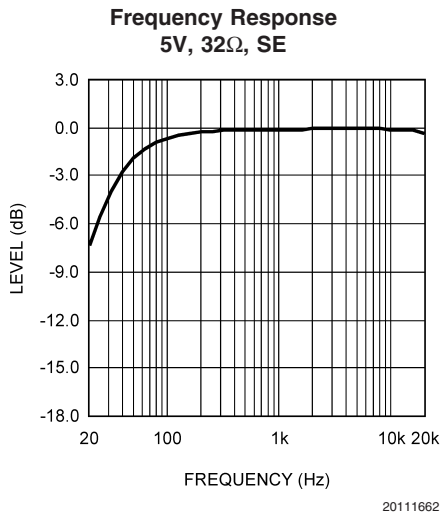
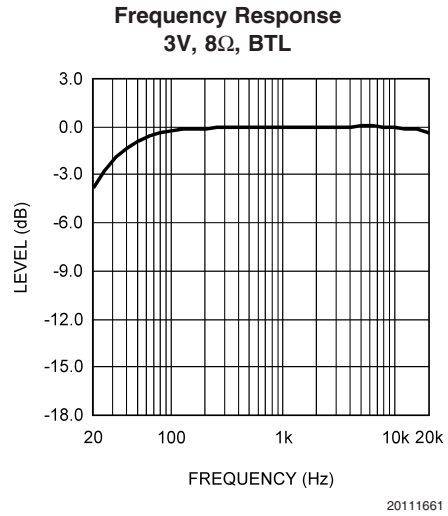
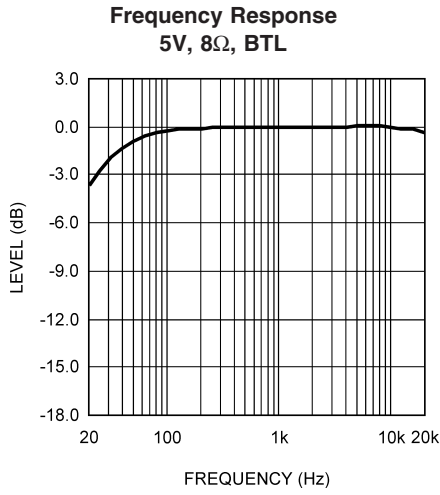

Typical Performance Characteristics (Continued)

Crosstalk
3V, 32Ω, SE

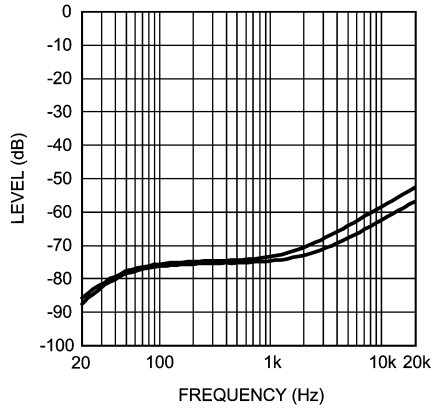

20111612

Crosstalk
5V, 32Ω, SE

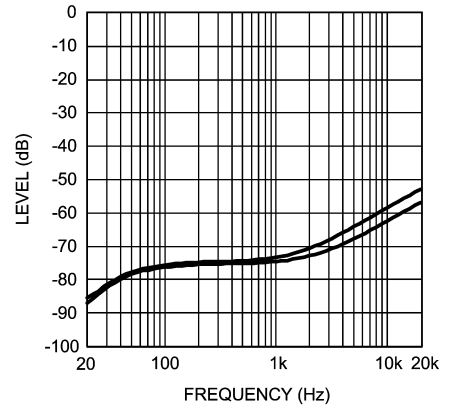

20111610

Dropout Voltage vs
Supply Voltage

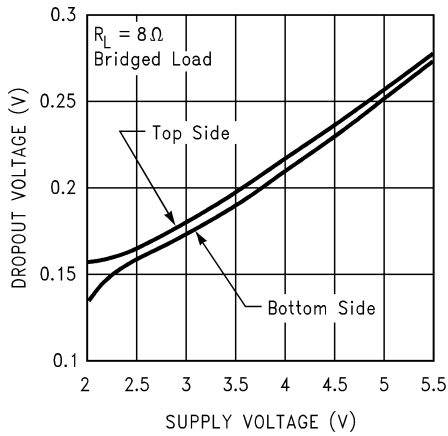

201116C0

Output Power vs
Supply Voltage

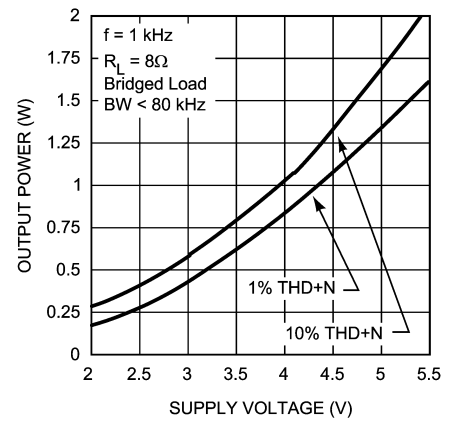

201116C2

Open Loop
Frequency Response

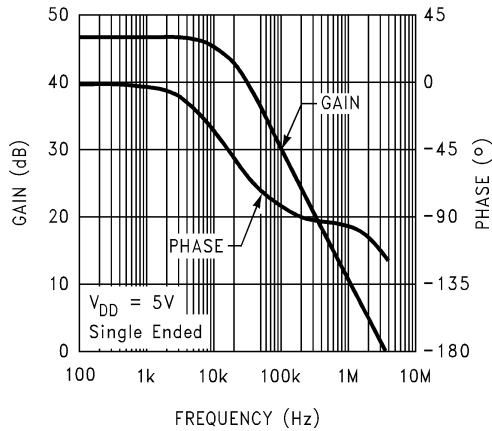

201116C1

Power Dissipation vs
Output Power

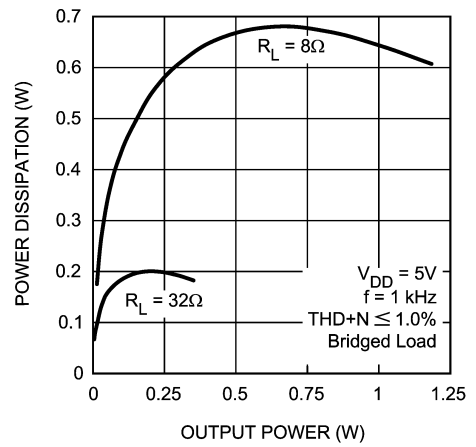

201116C4

Typical Performance Characteristics (Continued)

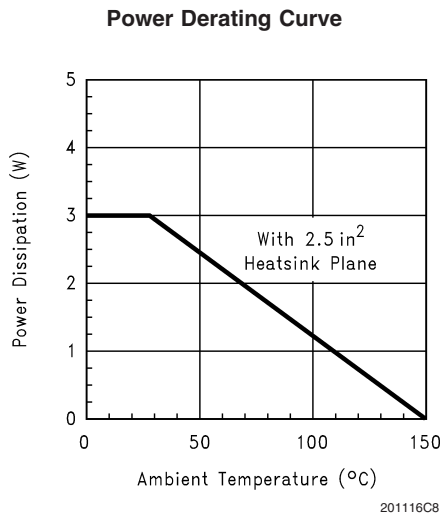
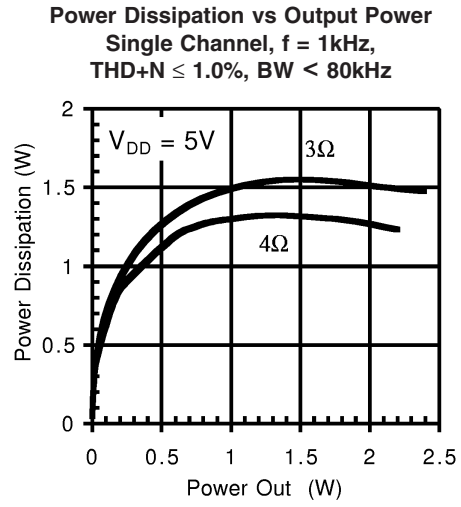
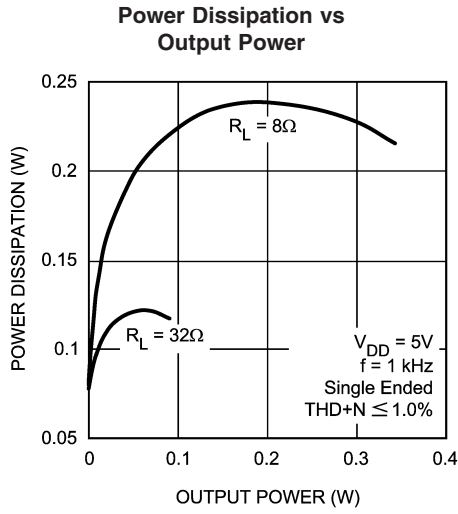

Application Information

EXPOSED-DAP PACKAGE PCB MOUNTING CONSIDERATIONS

The LM4888's SQ exposed-DAP (die attach paddle) package provides a low thermal resistance between the die and the PCB to which the part is mounted and soldered. This allows rapid heat transfer from the die to the surrounding PCB copper traces, ground plane and, finally, surrounding air. The result is a low voltage audio power amplifier that produces 2.1W at $\leq 1\%$ THD with a 4Ω load. This high power is achieved through careful consideration of necessary thermal design. Failing to optimize thermal design may compromise the LM4888's high power performance and activate unwanted, though necessary, thermal shutdown protection.

The SQ package must have its DAP soldered to a copper pad on the PCB. The DAP's PCB copper pad is connected to a large plane of continuous unbroken copper. This plane forms a thermal mass and heat sink and radiation area. Place the heat sink area on either outside plane in the case of a two-sided PCB, or on an inner layer of a board with more than two layers. Connect the DAP copper pad to the inner layer or backside copper heat sink area with 6 (3x2) SQ vias. The via diameter should be 0.012in–0.013in with a 1.27mm pitch. Ensure efficient thermal conductivity by plating-through and solder-filling the vias.

Best thermal performance is achieved with the largest practical copper heat sink area. If the heatsink and amplifier share the same PCB layer, a nominal 2.5in^2 (min) area is necessary for 5V operation with a 4Ω load. Heatsink areas not placed on the same PCB layer as the LM4888 should be 5in^2 (min) for the same supply voltage and load resistance. The last two area recommendations apply for 25°C ambient temperature. Increase the area to compensate for ambient temperatures above 25°C . In all circumstances and conditions, the junction temperature must be held below 150°C to prevent activating the LM4888's thermal shutdown protection. The LM4888's power de-rating curve in the **Typical Performance Characteristics** shows the maximum power dissipation versus temperature. Example PCB layouts for the exposed-Dap SQ package is shown in the **Demonstration Board Layout** section. Further detailed and specific information concerning PCB layout, fabrication, and mounting an SQ package is available from National Semiconductor's AN1187.

PCB LAYOUT AND SUPPLY REGULATION CONSIDERATIONS FOR DRIVING 3Ω AND 4Ω LOADS

Power dissipated by a load is a function of the voltage swing across the load and the load's impedance. As load impedance decreases, load dissipation becomes increasingly dependent on the interconnect (PCB trace and wire) resistance between the amplifier output pins and the load's connections. Residual trace resistance causes a voltage drop, which results in power dissipated in the trace and not in the load as desired. For example, 0.1Ω trace resistance reduces the output power dissipated by a 4Ω load from 2.1W to 2.0W. This problem of decreased load dissipation is exacerbated as load impedance decreases. Therefore, to maintain the highest load dissipation and widest output voltage swing, PCB traces that connect the output pins to a load must be as wide as possible.

Poor power supply regulation adversely affects maximum output power. A poorly regulated supply's output voltage decreases with increasing load current. Reduced supply voltage causes decreased headroom, output signal clipping,

and reduced output power. Even with tightly regulated supplies, trace resistance creates the same effects as poor supply regulation. Therefore, making the power supply traces as wide as possible helps maintain full output voltage swing.

BRIDGE CONFIGURATION EXPLANATION

As shown in Figure 1, the LM4888 consists of two pairs of operational amplifiers, forming a two-channel (channel A and channel B) stereo amplifier. External feedback resistors R2 (or R3, R4) and R8 (or R6, R7) and input resistors R1 and R9 set the closed-loop gain of Amp A (-out) and Amp B (-out) whereas two internal $20\text{k}\Omega$ resistors set Amp A's (+out) and Amp B's (+out) gain at 1. The LM4888 drives a load, such as a speaker, connected between the two amplifier outputs, -OUTA and +OUTA.

Figure 1 shows that Amp A's (-out) output serves as Amp A's (+out) input. This results in both amplifiers producing signals identical in magnitude, but 180° out of phase. Taking advantage of this phase difference, a load is placed between -OUTA and +OUTA and driven differentially (commonly referred to as "bridge mode"). This results in a differential gain of

$$A_{VD} = 2 * (R_f/R_i) \quad (1)$$

or

$$A_{VD} = 2 * (R_2/R_1)$$

Bridge mode amplifiers are different from single-ended amplifiers that drive loads connected between a single amplifier's output and ground. For a given supply voltage, bridge mode has a distinct advantage over the single-ended configuration: its differential output doubles the voltage swing across the load. This produces four times the output power when compared to a single-ended amplifier under the same conditions. This increase in attainable output power assumes that the amplifier is not current limited or that the output signal is not clipped. To ensure minimum output signal clipping when choosing an amplifier's closed-loop gain, refer to the **Audio Power Amplifier Design** section.

Another advantage of the differential bridge output is no net DC voltage across the load. This is accomplished by biasing channel A's and channel B's outputs at half-supply. This eliminates the coupling capacitor that single supply, single-ended amplifiers require. Eliminating an output coupling capacitor in a single-ended configuration forces a single-supply amplifier's half-supply bias voltage across the load. This increases internal IC power dissipation and may permanently damage loads such as speakers.

POWER DISSIPATION

Power dissipation is a major concern when designing a successful single-ended or bridged amplifier. Equation (2) states the maximum power dissipation point for a single-ended amplifier operating at a given supply voltage and driving a specified output load.

$$P_{D\text{MAX}} = (V_{DD})^2 / (2\pi^2 R_L) \quad \text{Single-Ended} \quad (2)$$

However, a direct consequence of the increased power delivered to the load by a bridge amplifier is higher internal power dissipation for the same conditions.

The LM4888 has two operational amplifiers per channel. The maximum internal power dissipation per channel operating in the bridge mode is four times that of a single-ended amplifier. From Equation (3), assuming a 5V power supply and a 4Ω load, the maximum single channel power dissipation is 1.27W or 2.54W for stereo operation.

$$P_{D\text{MAX}} = 4 * (V_{DD})^2 / (2\pi^2 R_L) \quad \text{Bridge Mode} \quad (3)$$

Application Information (Continued)

The LM4888's power dissipation is twice that given by Equation (2) or Equation (3) when operating in the single-ended mode or bridge mode, respectively. Twice the maximum power dissipation point given by Equation (3) must not exceed the power dissipation given by Equation (4):

$$P_{DMAX}' = (T_{JMAX} - T_A)/\theta_{JA} \quad (4)$$

The LM4888's $T_{JMAX} = 150^\circ\text{C}$. In the SQ package soldered to a DAP pad that expands to a copper area of 5in^2 on a PCB, the LM4888's θ_{JA} is 20°C/W . At any given ambient temperature T_A , use Equation (4) to find the maximum internal power dissipation supported by the IC packaging. Rearranging Equation (4) and substituting P_{DMAX} for P_{DMAX}' results in Equation (5). This equation gives the maximum ambient temperature that still allows maximum stereo power dissipation without violating the LM4888's maximum junction temperature.

$$T_A = T_{JMAX} - 2 * P_{DMAX} \theta_{JA} \quad (5)$$

For a typical application with a 5V power supply and an 4Ω load, the maximum ambient temperature that allows maximum stereo power dissipation without exceeding the maximum junction temperature is approximately 99°C for the SQ package.

$$T_{JMAX} = P_{DMAX} \theta_{JA} + T_A \quad (6)$$

Equation (6) gives the maximum junction temperature T_{JMAX} . If the result violates the LM4888's 150°C , reduce the maximum junction temperature by reducing the power supply voltage or increasing the load resistance. Further allowance should be made for increased ambient temperatures.

The above examples assume that a device is a surface mount part operating around the maximum power dissipation point. Since internal power dissipation is a function of output power, higher ambient temperatures are allowed as output power or duty cycle decreases.

If the result of Equation (2) is greater than that of Equation (3), then decrease the supply voltage, increase the load impedance, or reduce the ambient temperature. If these measures are insufficient, a heat sink can be added to reduce θ_{JA} . The heat sink can be created using additional copper area around the package, with connections to the ground pin(s), supply pin and amplifier output pins. External, solder attached SMT heatsinks such as the Thermalloy 7106D can also improve power dissipation. When adding a heat sink, the θ_{JA} is the sum of θ_{JC} , θ_{CS} , and θ_{SA} . (θ_{JC} is the junction-to-case thermal impedance, θ_{CS} is the case-to-sink

thermal impedance, and θ_{SA} is the sink-to-ambient thermal impedance.) Refer to the **Typical Performance Characteristics** curves for power dissipation information at lower output power levels.

POWER SUPPLY BYPASSING

As with any power amplifier, proper supply bypassing is critical for low noise performance and high power supply rejection. Applications that employ a 5V regulator typically use a $10\ \mu\text{F}$ in parallel with a $0.1\ \mu\text{F}$ filter capacitor to stabilize the regulator's output, reduce noise on the supply line, and improve the supply's transient response. However, their presence does not eliminate the need for a local $1.0\ \mu\text{F}$ tantalum bypass capacitance connected between the LM4888's supply pins and ground. Do not substitute a ceramic capacitor for the tantalum. Doing so may cause oscillation. Keep the length of leads and traces that connect capacitors between the LM4888's power supply pin and ground as short as possible.

MICRO-POWER SHUTDOWN

The voltage applied to the SHUTDOWN pin controls the LM4888's shutdown function. Activate micro-power shutdown by applying GND to the SHUTDOWN pin. When active, the LM4888's micro-power shutdown feature turns off the amplifier's bias circuitry, reducing the supply current. The low $0.04\ \mu\text{A}$ typical shutdown current is achieved by applying a voltage that is as near as GND as possible to the SHUTDOWN pin. A voltage that is more than GND may increase the shutdown current. *Table 1* shows the logic signal levels that activate and deactivate micro-power shutdown and headphone amplifier operation.

There are a few ways to control the micro-power shutdown. These include using a single-pole, single-throw switch, a microprocessor, or a microcontroller. When using a switch, connect an external 100k resistor between the SHUTDOWN pin and Ground. Connect the switch between the SHUTDOWN pin V_{DD} . Select normal amplifier operation by closing the switch. Opening the switch sets the SHUTDOWN pin to ground through the 100k resistor, which activates the micro-power shutdown. The switch and resistor guarantee that the SHUTDOWN pin will not float. This prevents unwanted state changes. In a system with a microprocessor or a microcontroller, use a digital output to apply the control voltage to the SHUTDOWN pin. Driving the SHUTDOWN pin with active circuitry eliminates the pull up resistor.

Application Information (Continued)

TABLE 1. Logic Level Truth Table

SHUTDOWN PIN	HEADPHONE LOGIC PIN	HEADPHONE JACK SENSE PIN	OPERATIONAL OUTPUT MODE
Logic High	High	Don't Care	SINGLE ENDED
Logic High	Low	Low (HP not plugged in)	BRIDGED/BTL
Logic High	Don't Care	High (HP plugged in)	SINGLE ENDED
Logic Low	Don't Care	Don't Care	Micro-Power Shutdown

HEADPHONE SENSE AND HEADPHONE LOGIC IN FUNCTIONS

Applying a logic level to the LM4888's HP Sense headphone control pin turns off Amp A (+out) and Amp B (+out) muting a bridged-connected load. Quiescent current consumption is reduced when the IC is in this single-ended mode.

Figure 2 shows the implementation of the LM4888's headphone control function. With no headphones connected to the headphone jack, the R11-R13 voltage divider sets the voltage applied to the HP Sense pin (pin 20) at approximately 50mV. This 50mV enables Amp A (+out) and Amp B (+out) placing the LM4888 in bridged mode operation.

While the LM4888 operates in bridged mode, the DC potential across the load is essentially 0V. Therefore, even in an ideal situation, the output swing cannot cause a false single-ended trigger. Connecting headphones to the headphone jack disconnects the headphone jack contact pin from -OUTA and allows R13 to pull the HP Sense pin up to V_{DD} . This enables the headphone function, turns off Amp A (+out) and Amp B (+out) which mutes the bridged speaker. The amplifier then drives the headphones, whose impedance is in parallel with resistors R10 and R11. These resistors have negligible effect on the LM4888's output drive capability since the typical impedance of headphones is 32Ω .

Figure 2 also shows the suggested headphone jack electrical connections. The jack is designed to mate with a three-wire plug. The plug's tip and ring should each carry one of the two stereo output signals, whereas the sleeve should carry the ground return. A headphone jack with one control pin contact is sufficient to drive the HP Sense pin when connecting headphones.

There is also a second input circuit that can control the choice of either BTL or SE modes. This input control pin is called the HP (Headphone) Logic Input. When the HP Logic input is high, LM4888 operates in SE mode. When HP Logic is low (& the HP Sense pin is low), the LM4888 operates in the BTL mode. In the BTL mode (HP Logic low and HP Sense Low) if the Headphones are connected directly to the Single Ended outputs (not using the HP Sense pin on the HP Jack) then both the Speaker (BTL) and Headphone (SE) will be functional. In this case the inverted op amp outputs drive the Speaker as well as the HP load, i.e. 8 ohms in parallel with 32 ohms. As the LM4888 is capable of driving up to a 3 ohm load driving the Speakers and the Headphones at the same time will not be a problem as long as the parallel resistance of each Speaker and each Headphone driver are more than 3 ohms.

As outlined above driving the Speaker (BTL) and Headphone (SE) loads simultaneously using LM4888 is simple and easy. However this configuration will only work if the HP Logic pin is used to control the BTL/SE operation and HP Sense pin is connected to GND.

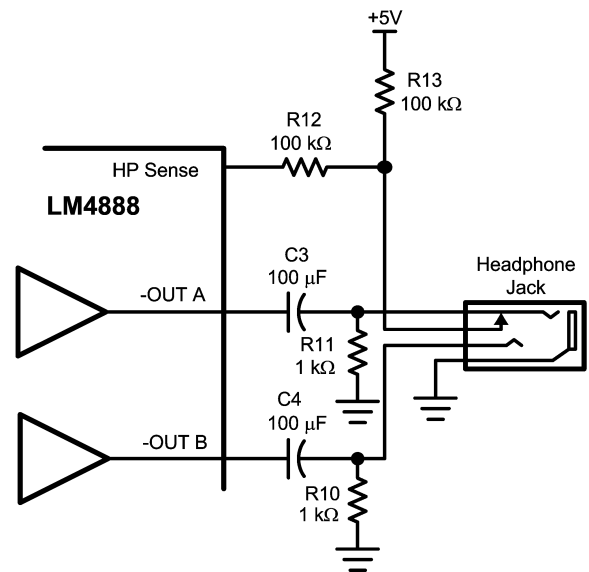

20111624

FIGURE 2. Headphone Circuit

SELECTING PROPER EXTERNAL COMPONENTS

Optimizing the LM4888's performance requires properly selecting external components. Though the LM4888 operates well when using external components with wide tolerances, best performance is achieved by optimizing component values.

The LM4888 is unity-gain stable, giving a designer maximum design flexibility. The gain should be set to no more than a given application requires. This allows the amplifier to achieve minimum THD+N and maximum signal-to-noise ratio. These parameters are compromised as the closed-loop gain increases. However, low gain demands input signals with greater voltage swings to achieve maximum output power. Fortunately, many signal sources such as audio CODECs have outputs of $1V_{RMS}$ (2.83V_{P-P}). Please refer to the **Audio Power Amplifier Design** section for more information on selecting the proper gain.

Input Capacitor Value Selection

Amplifying the lowest audio frequencies requires high value input coupling capacitors (C1 and C2) in Figure 1. A high value capacitor can be expensive and may compromise space efficiency in portable designs. In many cases, however, the speakers used in portable systems, whether internal or external, have little ability to reproduce signals below

Application Information (Continued)

150 Hz. Applications using speakers with this limited frequency response reap little improvement by using large input capacitor.

Besides effecting system cost and size, C1 and C2 have an effect on the LM4888's click and pop performance. When the supply voltage is first applied, a transient (pop) is created as the charge on the input capacitor changes from zero to a quiescent state. The magnitude of the pop is directly proportional to the input capacitor's size. Higher value capacitors need more time to reach a quiescent DC voltage (usually $V_{DD}/2$) when charged with a fixed current. The amplifier's output charges the input capacitor through the feedback resistors, R2 and R8. Thus, pops can be minimized by selecting an input capacitor value that is no higher than necessary to meet the desired -3dB frequency.

As shown in Figure 1, the input resistors (R1,4,5, and 6) and the input capacitors, C1 and C2 produce a -3dB high pass filter cutoff frequency that is found using Equation (7).

$$f_{-3dB} = \frac{1}{2\pi R_{IN} C_{IN}} = \frac{1}{2\pi R1 C1} \quad (7)$$

As an example when using a speaker with a low frequency limit of 150Hz, C₁, using Equation (7) is 0.053μF. The .33μF C₁ shown in Figure 1 allows the LM4888 to drive high efficiency, full range speaker whose response extends below 30Hz.

Bypass Capacitor Value Selection

Besides minimizing the input capacitor size, careful consideration should be paid to value of C₆, the capacitor connected to the BYPASS pin. Since C₆ determines how fast the LM4888 settles to quiescent operation, its value is critical when minimizing turn-on pops. The slower the LM4888's outputs ramp to their quiescent DC voltage (nominally 1/2 V_{DD}), the smaller the turn-on pop. Choosing C₆ equal to 1.0 μF along with a small value of C₁ (in the range of 0.1 μF to 0.39 μF), produces a click-less and pop-less shutdown function. As discussed above, choosing C₁ no larger than necessary for the desired bandwidth helps minimize clicks and pops. Connecting a 1μF capacitor, C₆, between the BYPASS pin and ground improves the internal bias voltage's stability and improves the amplifier's PSRR.

OPTIMIZING CLICK AND POP REDUCTION PERFORMANCE

The LM4888 contains circuitry that minimizes turn-on and shutdown transients or "clicks and pop". For this discussion, turn-on refers to either applying the power supply voltage or when the shutdown mode is deactivated. When the part is turned on, an internal current source changes the voltage of the BYPASS pin in a controlled, linear manner. Ideally, the input and outputs track the voltage applied to the BYPASS pin. The gain of the internal amplifiers remains unity until the voltage on the bypass pin reaches 1/2 V_{DD}. As soon as the voltage on the bypass pin is stable, the device becomes fully operational. Although the BYPASS pin current cannot be modified, changing the size of C₆ alters the device's turn-on time and the magnitude of "clicks and pops". Increasing the value of C₆ reduces the magnitude of turn-on pops. However, this presents a tradeoff: as the size of C₆ increases, the turn-on time increases. There is a linear relationship between the size of C₆ and the turn-on time. Here are some typical turn-on times for various values of C₆:

C ₆	T _{ON}
0.01μF	30ms
0.1μF	40ms
0.22μF	60ms
0.47μF	80ms
1.0μF	140 ms

In order eliminate "clicks and pops", all capacitors must be discharged before turn-on. Rapidly switching V_{DD} on and off may not allow the capacitors to fully discharge, which may cause "clicks and pops".

AUDIO POWER AMPLIFIER DESIGN

Audio Amplifier Design: Driving 1W into an 8Ω Load

The following are the desired operational parameters:

Power Output:	1W _{RMS}
Load Impedance:	8Ω
Input Level:	1V _{rms}
Input Impedance:	20kΩ
Bandwidth:	100Hz–20kHz ± 0.25dB

The design begins by specifying the minimum supply voltage necessary to obtain the specified output power. One way to find the minimum supply voltage is to use the Output Power vs Supply Voltage curve in the **Typical Performance Characteristics** section. Another way, using Equation (8), is to calculate the peak output voltage necessary to achieve the desired output power for a given load impedance. To account for the amplifier's dropout voltage, two additional voltages, based on the Dropout Voltage vs Supply Voltage in the **Typical Performance Characteristics** curves, must be added to the result obtained by Equation (8). The result in Equation (9).

$$V_{OUTPEAK} = \sqrt{(2R_L P_O)} \quad (8)$$

$$V_{DD} \geq (V_{OUTPEAK} + (V_{ODTOP} + V_{ODBOT})) \quad (9)$$

The Output Power vs Supply Voltage graph for an 8Ω load indicates a minimum supply voltage of 4.35V for a 1W output at 1% THD+N. This is easily met by the commonly used 5V supply voltage. The additional voltage creates the benefit of headroom, allowing the LM4888 to produce peak output power in excess of 1.3W at 5V of V_{DD} and 1% THD+N without clipping or other audible distortion. The choice of supply voltage must also not create a situation that violates maximum power dissipation as explained above in the **Power Dissipation** section.

After satisfying the LM4888's power dissipation requirements, the minimum differential gain needed to achieve 1W dissipation in an 8Ω load is found using Equation (10).

$$A_{VD} \geq \sqrt{(P_O R_L)} / (V_{IN}) = V_{orms} / V_{inrms} \quad (10)$$

Thus, a minimum gain of 2.83 allows the LM4888's to reach full output swing and maintain low noise and THD+N performance. For this example, let $A_{VD} = 3$.

The amplifier's overall gain (non 3D mode) is set using the input (R1 and R9) and feedback resistors R2 and R8. With the desired input impedance set at 20kΩ, the feedback resistor is found using Equation (11).

$$R_2 / R_1 = A_{VD} / 2 \quad (11)$$

Application Information (Continued)

The value of R_f is 30k Ω .

The last step in this design example is setting the amplifier's -3dB frequency bandwidth. To achieve the desired ± 0.25 dB pass band magnitude variation limit, the low frequency response must extend to at least one-fifth the lower bandwidth limit and the high frequency response must extend to at least five times the upper bandwidth limit. The gain variation for both response limits is 0.17dB, well within the ± 0.25 dB desired limit. The results are an

$$f_L = 100\text{Hz}/5 = 20\text{Hz}$$

and an

$$f_H = 20\text{kHz} \times 5 = 100\text{kHz}.$$

As mentioned in the **External Components** section, R_1 and C_1 create a highpass filter that sets the amplifier's lower bandpass frequency limit. Find the coupling capacitor's value using Equation (12).

$$C_1 \geq 1/(2\pi R_1 f_L) \quad (12)$$

The result is

$$1/(2\pi \times 20\text{k}\Omega \times 20\text{Hz}) = 0.398\mu\text{F}.$$

Use a 0.39 μ F capacitor, the closest standard value.

The product of the desired high frequency cutoff (100kHz in this example) and the differential gain, A_{VD} , determines the upper passband response limit. With $A_{VD} = 3$ and $f_H = 100\text{kHz}$, the closed-loop gain bandwidth product (GBWP) is 300kHz. This is less than the LM4888's 3.5MHz GBWP. With this margin, the amplifier can be used in designs that require more differential gain while avoiding performance-restricting bandwidth limitations.

NATIONAL 3D ENHANCEMENT

The LM4888 features a 3D audio enhancement effect that widens the perceived soundstage from a stereo audio signal.

The 3D audio enhancement improves the apparent stereo channel separation whenever the left and right speakers are too close to one another, due to system size constraints or equipment limitations.

An external RC network, Shown in figure 1, is required to enable the 3D effect. The amount of the 3D effect is set by the R_5 and C_7 or C_{3D} ADJ. Decreasing the value of R_5 will increase the 3D effect. Increasing the value of the capacitors (C_7 or C_{3D}) will decrease the low cutoff frequency at which the 3D effect starts to occur., as shown by Equation 13.

$$F_{3D(-3dB)} = 1 / 2\pi(R_{3D})(C_{3D}) \quad (13)$$

Activating the 3D effect by applying V_{DD} to pin 9 (3D Control) will cause an increase in gain by a multiplication factor of $(1 + 20\text{k}\Omega/R_5)$. Setting R_5 to 20k Ω will result in a gain increase by a multiplication factor of $(1 + 20\text{k}\Omega/20\text{k}\Omega) = 2$ or 6dB whenever the 3D effect is activated. The amount of perceived 3D is also dependent on many other factors such as speaker placement and the distance to the listener. Therefore, it is recommended that the user try various values of R_5 and C_{3D} to get a feel for how the 3D effect works in the application. There is not a "right or wrong" for the effect, it is merely what is most pleasing to the individual user. Take note that R_3 and R_4 replace R_2 , and R_7 and R_6 replace R_8 when 3D mode is enabled.

RECOMMENDED PRINTED CIRCUIT BOARD LAYOUT

Figures 3 through 6 show the recommended two-layer PC board layout that is optimized for the 24-pin SQ package. These circuits are designed for use with an external 5V supply and 8 Ω , 4 Ω , 3 Ω speakers.

These circuit boards are easy to use. Apply power and ground to the board's V_{DD} and GND pads, respectively. Connect the speakers between the board's -OUTA and +OUTA and OUTB and +OUTB pads.

Demonstration Board Layout

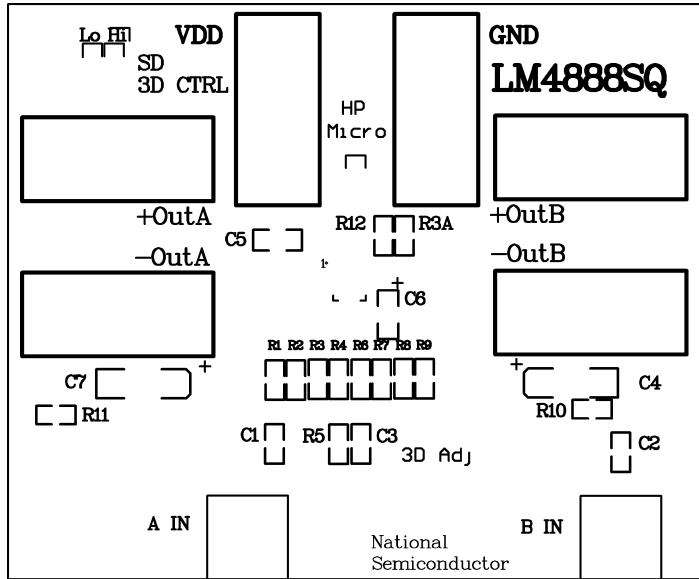

FIGURE 3. Silkscreen

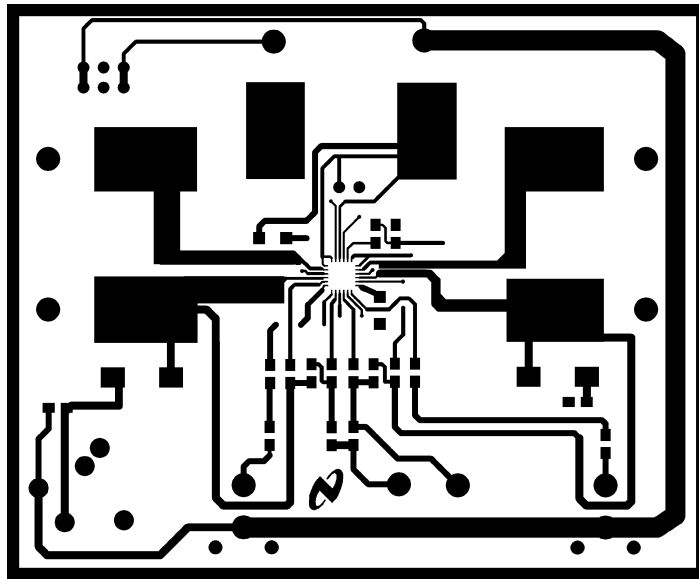
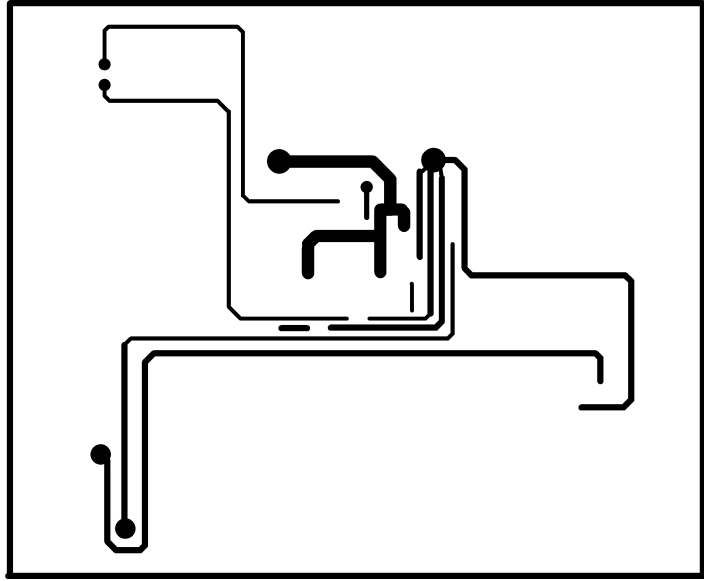

FIGURE 4. Top Layer

Demonstration Board Layout (Continued)



20111606

FIGURE 5. Mid layer

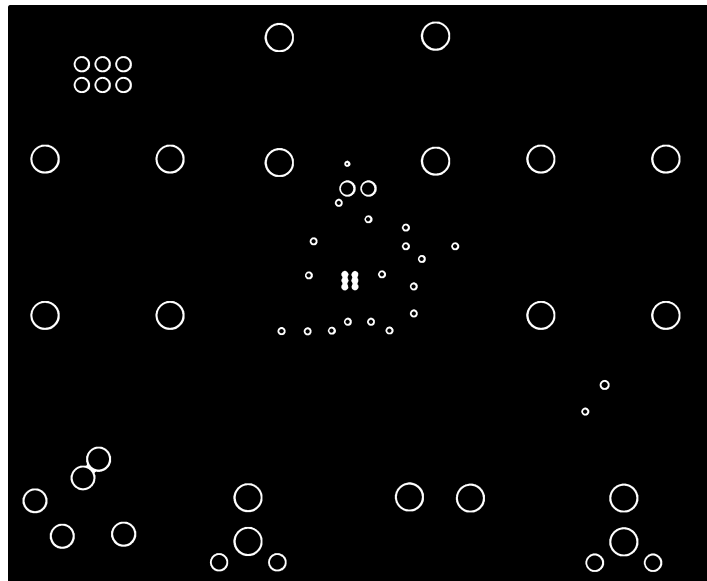

20111608

FIGURE 6. Bottom Layer

Bill of Materials

Analog Audio LM4888SQ Eval Board

Assembly Part Number: 551012279-001

Revision: A

Item	Part Number	Part Description	Qty	Ref Designator	Remark
1	551012279-001	LM4888 Eval Board PCB etch 001	1		
2		IC LM4888SQ	1	U1	
3		Tant Cap 0.22 μ F 50V 10%	4	C1, C2	
4		Tant Cap 1 μ F 16V 10% Size = A 3216	2	C5, C6	
5		Tant Cap 100 μ F 16V 10% Size = D 7343	2	C3, C4	
6		Cer Capacitor 1nF	1	C7	
7		Res 1k Ω 1/8W 1% 0805	2	R10, R11	
8		Res 10k Ω 1/8W 1% 0805	4	R3, R4, R6, R7	
9		Res 20k Ω 1/8W 1% 0805	5	R1, R2,R5, R8, R9	
10		Res 100k Ω 1/8W 1% 0805	2	R12, R13	
11		RCA Jack	2	INA, INB	Mouser # 16PJ097
12		Banana Jack, Black	3	-OutA,- OutB, GND	Mouser # ME164-6218
13		Banana Jack, Red	3	+OutA,+ OutB, VDD	Mouser # ME164-6219
14		Jumper Header 3 x 1	2	SD, MUX	
15		Jumper Header (2x)	1	HP Logic	

Revision History

Rev	Date	Description
1.0	6/09/05	Changed the doc title from LM4888SQ into LM4888, then re-released D/S to the WEB (per Steve K. (MC)
1.1	3/06/06	Edited graphics 201116 01.. Typ Appl Ckt Dg (new # 201116 29) and 201116 02.. SQ package drawing (new # 201116 28), then re-released D/S to the WEB per Mark B.

Physical Dimensions inches (millimeters) unless otherwise noted

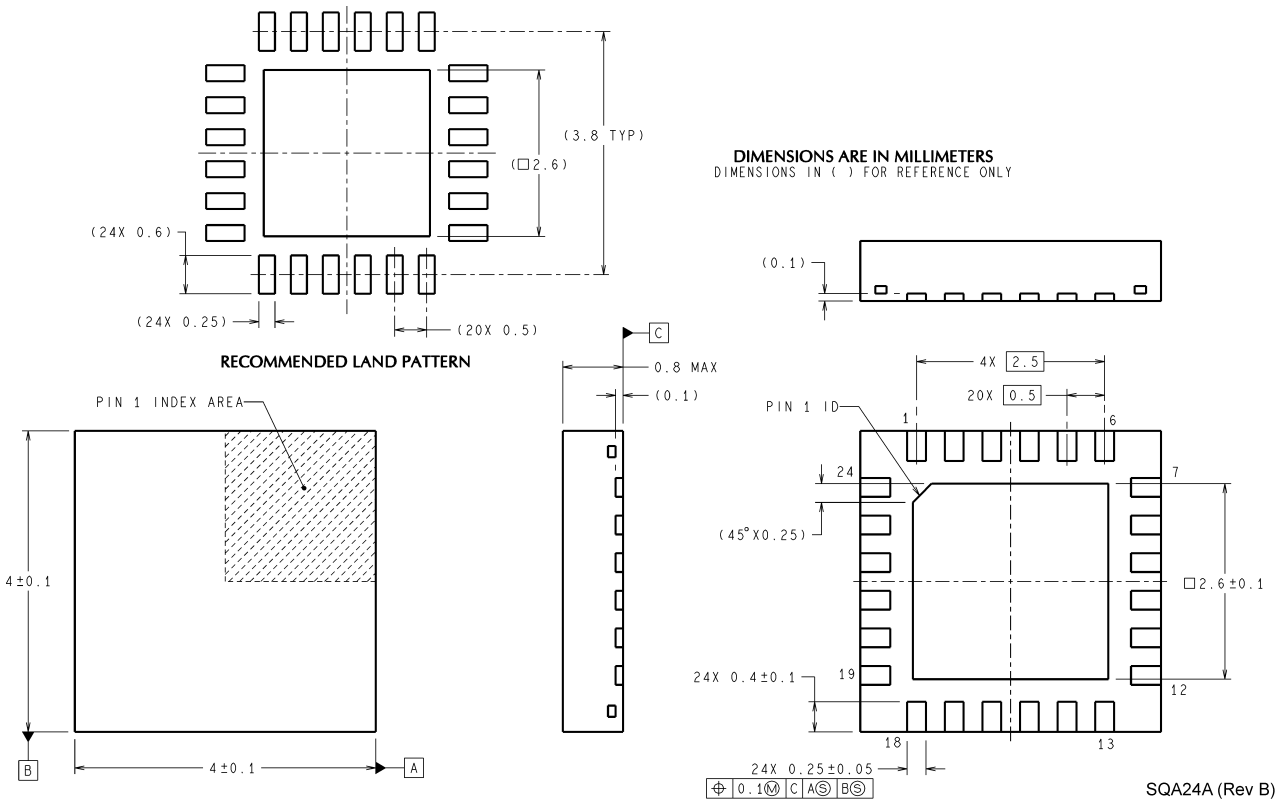

LLP Package
Order Number LM4888SQ
NS Package Number SQA24A

National does not assume any responsibility for use of any circuitry described, no circuit patent licenses are implied and National reserves the right at any time without notice to change said circuitry and specifications.
 For the most current product information visit us at www.national.com.

LIFE SUPPORT POLICY

NATIONAL'S PRODUCTS ARE NOT AUTHORIZED FOR USE AS CRITICAL COMPONENTS IN LIFE SUPPORT DEVICES OR SYSTEMS WITHOUT THE EXPRESS WRITTEN APPROVAL OF THE PRESIDENT AND GENERAL COUNSEL OF NATIONAL SEMICONDUCTOR CORPORATION. As used herein:

1. Life support devices or systems are devices or systems which, (a) are intended for surgical implant into the body, or (b) support or sustain life, and whose failure to perform when properly used in accordance with instructions for use provided in the labeling, can be reasonably expected to result in a significant injury to the user.
2. A critical component is any component of a life support device or system whose failure to perform can be reasonably expected to cause the failure of the life support device or system, or to affect its safety or effectiveness.

BANNED SUBSTANCE COMPLIANCE

National Semiconductor manufactures products and uses packing materials that meet the provisions of the Customer Products Stewardship Specification (CSP-9-111C2) and the Banned Substances and Materials of Interest Specification (CSP-9-111S2) and contain no "Banned Substances" as defined in CSP-9-111S2.
 Leadfree products are RoHS compliant.



National Semiconductor
Americas Customer Support Center
 Email: new.feedback@nsc.com
 Tel: 1-800-272-9959

National Semiconductor
Europe Customer Support Center
 Fax: +49 (0) 180-530 85 86
 Email: europe.support@nsc.com
 Deutsch Tel: +49 (0) 69 9508 6208
 English Tel: +44 (0) 870 24 0 2171
 Français Tel: +33 (0) 1 41 91 8790

National Semiconductor
Asia Pacific Customer Support Center
 Email: ap.support@nsc.com

National Semiconductor
Japan Customer Support Center
 Fax: 81-3-5639-7507
 Email: jpn.feedback@nsc.com
 Tel: 81-3-5639-7560

www.national.com