

LM4753 Dual 10W Audio Power Amplifier w/Mute, Standby and Volume Control

General Description

The LM4753 is a stereo audio amplifier capable of delivering 10W/channel at 10% distortion into a 8Ω load. The power amp has an internally set gain of 30 dB. A 0V–5V DC controlled volume block provides 80 dB of attenuation from input to line-out. Line outputs are available after the volume control for signal routing.

The amplifier has a smooth transition fade-in/out mute and a power conserving standby function which are controlled through TTL or CMOS logic. Both functions provide over 75 dB of attenuation.

The LM4753 maintains an excellent Signal-to-Noise ratio of greater than 70 dB with a low noise floor less than 2 mV. The IC also maintains above 50 dB of channel separation.

The LM4753 is available in a 15-lead non-isolated plastic package and is designed for use in TV applications requiring single supply operation.

Key Specifications

- Output power into 8Ω at 10% THD 10W
- Maximum operating voltage 28V
- Power output stage Noise floor 2 mV
- Line output Noise floor 55 μV
- 0V–5V DC controlled volume attenuation 80 dB
- Mute attenuation 75 dB
- Standby-mode supply current 7 mA

Features

- Quiet fade-in/out mute function
- Stereo variable line-out pins
- AC output short circuit protection
- Thermal shutdown protection

Applications

- Stereo TVs
- Component stereo
- Compact stereo

Typical Application

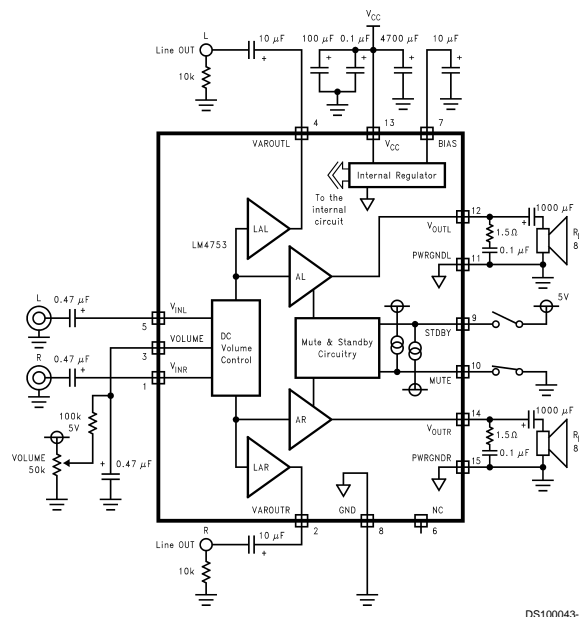
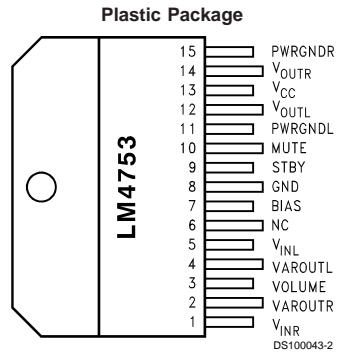

FIGURE 1. Typical Audio Amplifier Application Circuit

Connection Diagram



Top View
Order Number
See NS Package Number TA15A for
Staggered Lead Non-Isolated Package

Absolute Maximum Ratings (Notes 3, 4)

If Military/Aerospace specified devices are required, please contact the National Semiconductor Sales Office/ Distributors for availability and specifications.

Supply Voltage	32V
Output Current	Internally Limited
Power Dissipation (Note 5)	22W
ESD Susceptibility (Note 6)	2000V
ESD Susceptibility (Note 7)	250V
Junction Temperature	150°C

Soldering Information

T Package (10 sec)	260°C
Storage Temperature	-40°C to +150°C
Input Signal Voltage Range	±3V

Operating Ratings (Notes 3, 4)

Temperature Range	
$T_{MIN} \leq T_A \leq T_{MAX}$	-40°C ≤ T _A ≤ +85°C
Supply Voltage	15V to 28V
θ_{JA} (Junction to Ambient)	35°C/W
θ_{JC} (Junction to Case)	1.5°C/W

Electrical Characteristics (Notes 3, 4)

The following specifications apply for V_{CC} = +22V, and Volume @ 0 dB unless otherwise specified. Limits apply for T_A = 25°C.

Symbol	Parameter	Conditions	LM4753		Units (Limits)
			Typical (Note 8)	Limit (Note 9)	
I _{CCQ} (Note 1)	Total Quiescent Power Supply Current	V _{CM} = 0V, V _o = 0V, I _o = 0 mA		20	mA (min)
			80	140	
I _{STBY} (Note 1)	Standby Current	V _{STDBY} = 5V, Standby-on	7	10	mA (max)
I _{MUTE}	Mute Current	V _{MUTE} = 5V Mute-on	13	20	mA
A _M (Note 2)	Mute Attenuation	V _{MUTE} = 5V, V _{STDBY} = 0V. Mute-on Signal Input	75	60	dB (min)
		V _{MUTE} = 0V, V _{STDBY} = 0V. Mute-off 2 V _{rms}	±5		dB
	Volume Attenuation Range		80	70	dB (min)
	Volume Absolute Attenuation Line-out	Pin 3 @ 0V = 80 dB, 2V = 14 dB, 3V = 8 dB, 4V = 3 dB, 5V = 0 dB	±3	±5	dB (max)
	Line-out Offset Voltage		20	40	mV (max)
P _O (Note 1)	Output Power (Continuous Average)	THD+N = 10% (max)			W
		f = 1 kHz, R _L = 8Ω, V _{CC} = 28	11.8		W(min)
		f = 1 kHz, R _L = 8Ω, V _{CC} = 22V	7	6.5	
THD+N (Note 2)	Total Harmonic Distortion Plus Noise	P _o = 1W, f = 1 kHz, R _L = 8Ω	0.4	1	% (max)
Xtalk (Note 2)	Channel Separation	f = 1 kHz, P _o = 5W, R _L = 8Ω	50		dB
	Power Amp Closed-Loop Gain Error	Internal Gain = 30 dB	0.5	±1	dB (max)
SR (Note 2)	Slew Rate	V _{IN} = 100 mVp-p, t _{RISE} = 2 ns, R _L = 8Ω	3		V/μs
R _{IN} (Note 1)	Input Impedance		32		kΩ
I _O (Note 1)	Output Current Limit	V _{IN} = 100 mV DC, t _{ON} = 1 ms, R _L = 1Ω	2.5	2.0	A(min)
PSRR (Note 2)	Power Supply Rejection Ratio	V _{pin 13 AC} = 1 V _{rms} , f = 100 Hz V _{CM} = 0V, I _o = 0 mA	50		dB
GBWP	Gain-Bandwidth Product	f _o = 100 kHz, V _{IN} = 50 mvrms	2		MHz
	Power Bandwidth	-3 dB Bandwidth at 5W	90		kHz
eVCA _{out}	VCA Output Noise	IHF - A Weighting Filter R _{IN} = 25Ω	55		μV
e _{out}	Power Amp Output Noise	IHF - A Weighting Filter R _{IN} = 25Ω	1.8		mV
SNR	Signal-to-Noise Ratio	Measured at 1 kHz, R _s = 25Ω P _o = 4.8W, A - Weighted,	70		dB

Electrical Characteristics (Notes 3, 4) (Continued)

The following specifications apply for $V_{CC} = +22V$, and Volume @ 0 dB unless otherwise specified. Limits apply for $T_A = 25^\circ C$.

Symbol	Parameter	Conditions	LM4753		Units (Limits)
			Typical (Note 8)	Limit (Note 9)	
Standby					
V_{IL}	Standby Low Input Voltage			0.8	V (max)
V_{IH}	Standby High Input Voltage			2.0	V (min)
Mute					
V_{IL}	Mute Low Input Voltage			0.8	V (max)
V_{IH}	Mute High Input Voltage			2.0	V (min)

Note 1: DC Electrical Test.

Note 2: AC Electrical Test.

Note 3: Absolute Maximum Ratings indicate limits beyond which damage to the device may occur. **Operating Ratings** indicate conditions for which the device is functional, but do not guarantee specific performance limits. **Electrical Characteristics** state DC and AC electrical specifications under particular test conditions which guarantee specific performance limits. This assumes that the device is within the Operating Ratings. Specifications are not guaranteed for parameters where no limit is given, however, the typical value is a good indication of device performance.

Note 4: All voltages are measured with respect to the ground (pin 8), unless otherwise specified.

Note 5: The maximum power dissipation must be derated at elevated temperatures and is dictated by T_{JMAX} , θ_{JA} , and the ambient temperature, T_A . The maximum allowable power dissipation is $PD_{MAX} = (T_{JMAX} - T_A)/\theta_{JA}$ or the number given in the Absolute Maximum Ratings, whichever is lower. For operating at case temperatures above $25^\circ C$, the device must be derated based on a $150^\circ C$ maximum junction temperature and a thermal resistance of $\theta_{JC} = 5^\circ C/W$ (junction to case).

Note 6: Human body model, 100 pF discharged through a 1.5 k Ω resistor.

Note 7: Machine model, 200 pF–240 pF discharge through all pins.

Note 8: Typicals are measured at $25^\circ C$ and represent the parametric norm.

Note 9: Limits are guarantees that all parts are tested in production to meet the stated values.

Standby Mute Pin Function Table

Standby (Pin 9)	Mute (Pin 10)	Operating Condition
"L" or Open	"L"	Play
"L" or Open	"H" or Open	Mute
"H"	"L"	Standby
"H"	"H" or Open	Standby

Typical Performance Characteristics

THD+N vs Frequency

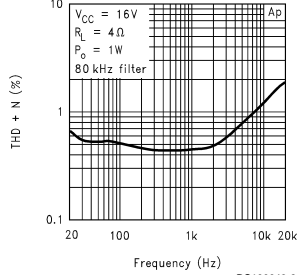

THD+N vs Frequency

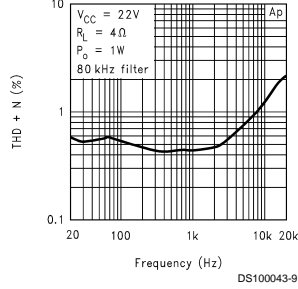

Output Power vs Supply Voltage

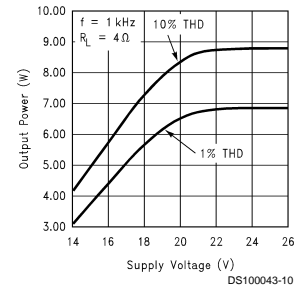

THD+N vs Frequency

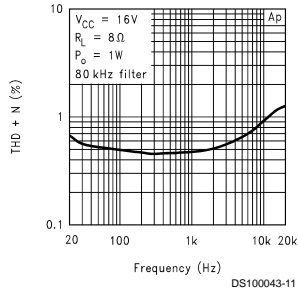

THD+N vs Frequency

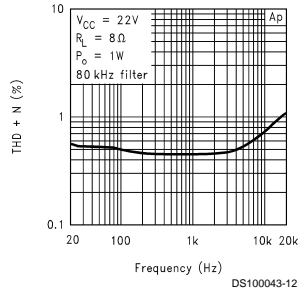

Output Power vs Supply Voltage

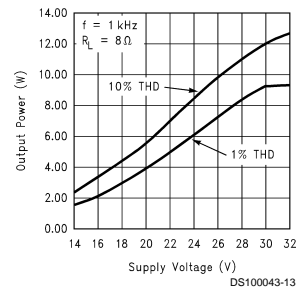

THD+N vs Output Power

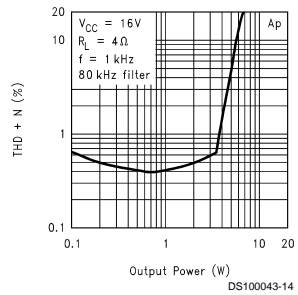

THD+N vs Output Power

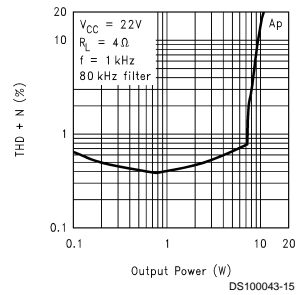

THD+N vs Output Power

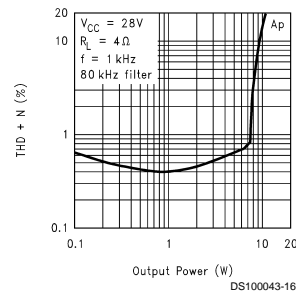

THD+N vs Output Power

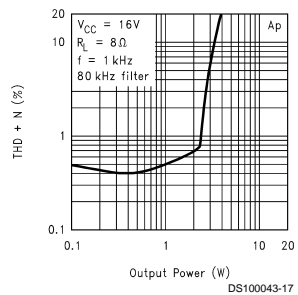

THD+N vs Output Power

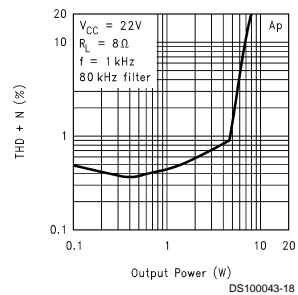

THD+N vs Output Power

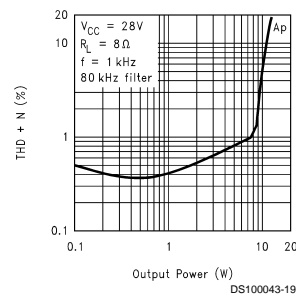

Typical Performance Characteristics (Continued)

Supply Current vs Supply Voltage

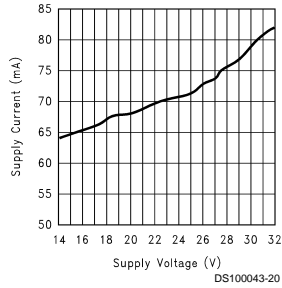

Power Dissipation vs Output Power

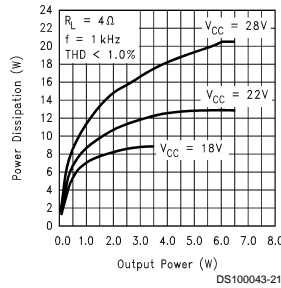

Power Dissipation vs Output Power

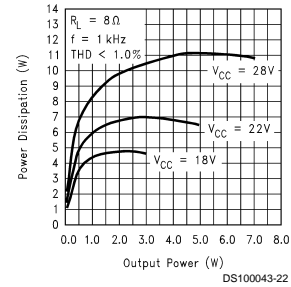

Channel Separation vs Frequency

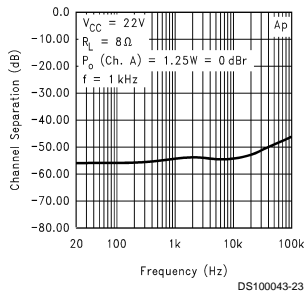

Attenuation vs Frequency

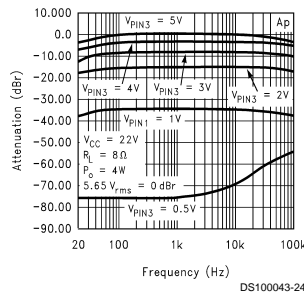

Volume Attenuation vs DC Voltage

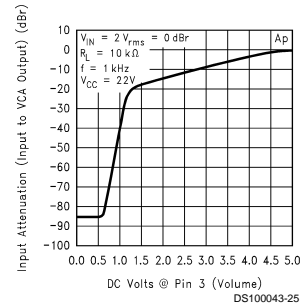

Application Information

GENERAL FEATURES

The LM4753 has a number of valuable functions that make this audio amplifier IC an all-in-one solution. The IC has a stereo audio path from input to output with a DC voltage controlled volume attenuator in the preamp section. After the volume attenuator is a line-out connection for preamp-out control. The attenuation curve versus DC voltage can be found by referring to the Volume Attenuation vs DC Voltage graph in the Typical Performance Characteristics section. The IC also possesses a mute function to provide audio attenuation as used on a remote control for a TV, as well as a standby function for power conservation when not being used. The IC is well protected with thermal shutdown and output AC short circuit protection.

Mute Function

The muting function of the LM4753 allows the user to mute the music going into the amplifier, providing over 60 dB of attenuation from input to output. The function is enabled by placing a logic "1" or 5V onto the mute pin, pin 10. To disable the function, allowing music to be passed to the output, a logic "0" or 0V should be placed on the mute pin. By placing the device into mute mode, each of the power amplifier outputs are simultaneously muted. The DC volume control and line-out amplifiers are not affected by the mute function. Please refer to *Table 1* for each input condition.

To prevent mechanical switch bouncing from adversely affecting the functionality of the IC, an RC lowpass filter should be used as shown in *Figure 2*. This circuit replaces the need for a debounce circuit when using a mechanical switch to control the IC logic functions. However, most systems typically utilize a microprocessor or COP microcontroller to interface with the logic control functions of the LM4753. When a clean logic signal is used, as from a microcontroller, the RC lowpass filter is not required.

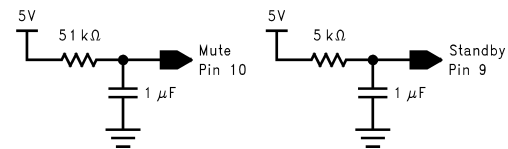

FIGURE 2. Mute and Standby Pin Lowpass Filters

Standby Function

The standby function allows the user to place the LM4753 into a power conserving mode that draws less than 10 mA of quiescent power supply current. With the IC in this mode, while using +22V for the supply voltage, the IC draws about 150 mW of power.

The standby function is enabled by placing a logic "1" or 5V onto the standby pin, pin 9. To disable the function allowing music to be passed to the output, a logic "0" or 0V should be placed on the standby pin. When the standby function is en-

Application Information (Continued)

abled, it overrides the mute function and places the IC in its power conserving mode. If the mute function is enabled while in standby mode, the IC will continue to remain in standby mode. After the standby function is disabled, the IC will be placed into mute mode. Please refer to the *Table 1* for each input condition.

TABLE 1. Mute and Standby Functional Conditions

Standby (Pin 9)	Mute (Pin 10)	Operating Conditions
0V or open	0V	Music Plays
0V or open	5V or open	Mute Mode
5V	0V	Standby Mode
5V	5V or open	Standby Mode

To prevent mechanical switch bouncing from adversely affecting the functionality of an IC, an RC lowpass filter should be used as shown in *Figure 2*. This circuit replaces the need for a debounce circuit when using a mechanical switch to control the IC logic functions. However, most systems typically utilize a microprocessor or COP microcontroller to interface with the logic control functions of the LM4753. When a clean logic signal is used, as from a microcontroller, the RC lowpass filter is not required.

DC Volume Control

The DC volume control for the LM4753 works between 0V and 5V. When the volume pin (pin 3) is 0V, the IC's preamp stage is fully attenuated to 80 dB. When the volume pin is at 5V, the preamp stage passes audio at 0 dB.

The DC volume attenuation curve for the LM4753 is intended to provide smooth accurate attenuation changes at higher DC voltages, but then attenuate fast to 80 dB at lower DC voltages. This means that when the volume control is turned down, the amplification is quickly attenuated, while at normal listening levels, attenuation changes are more gradual. Please refer to the Volume Attenuation vs DC Voltage curve in the Typical Performance Characteristics section.

The DC voltage to pin 3 can be controlled with a potentiometer as shown in *Figures 1, 3*. A 100 k Ω resistor and a 1 μ F capacitor form an RC lowpass filter that keeps any unnecessary noise from coupling into the device. Any noise that is coupled into the device is gained up by 40 dB.

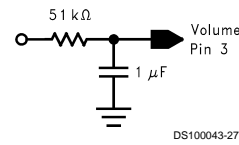

FIGURE 3. Volume Pin Lowpass Filter

Turn On/Off Characteristics

In order to minimize turn on and off pops, the LM4753 should be powered up by using the sequence described below. *Figure 4* shows the sequence for turn on and off.

Since the power supply voltage of the power amplifier is about 4 times more than a 5V power supply, it is assumed that the logic voltage supply for the standby and mute functions is up before the large power supply reservoir capacitors are charged. The LM4753 should be placed into standby mode before the undervoltage protection circuitry is disabled. The undervoltage protection circuitry will keep the outputs of the LM4753 at 0V until the voltage from V_{CC} to GND is about 9.5V. If the standby function is disabled when the supply voltage exceeds this value, the single-supply biasing of the output stage will then begin to charge up to $V_{CC}/2$. The pop performance under this condition is quite good, however, it is highly recommended that the Mute and Standby pin voltages are high at 5V while the main power supply voltage, V_{CC} , is ramping up.

Once the main supply voltage is up to its full value, the standby function can then be brought low to 0V. The biasing of the amplifier and the output stage will then begin to charge up to $V_{CC}/2$. Notice that the supply current draw is approximately 7 mA until the standby function is disabled, at which point, the supply current increases to approximately 13 mA while in mute mode.

Once the single-supply biasing is established, the mute pin voltage can be brought down to 0V, allowing the IC to amplify the input signal. As shown in *Figure 4*, the input signal that is applied to the IC all throughout the power-up process is not passed to the speaker until the mute function is disabled. The typical quiescent power supply current while in play mode is approximately 80 mA.

The same sequence should be applied when powering down the device. First the IC should be placed into mute mode, muting the output, then placed into standby mode where the bias and output coupling caps are gradually discharged to ground. Once the biasing of the IC is brought to ground, the main power supplies can be powered down. This power-up and power-down sequence is highly recommended. Abrupt changes in output current from enabling standby while the output is driving an inductive load (like a speaker) may cause the IC to handle extreme levels of power due to inductive kickback. The IC may not be able to handle this and should be avoided.

Application Information (Continued)

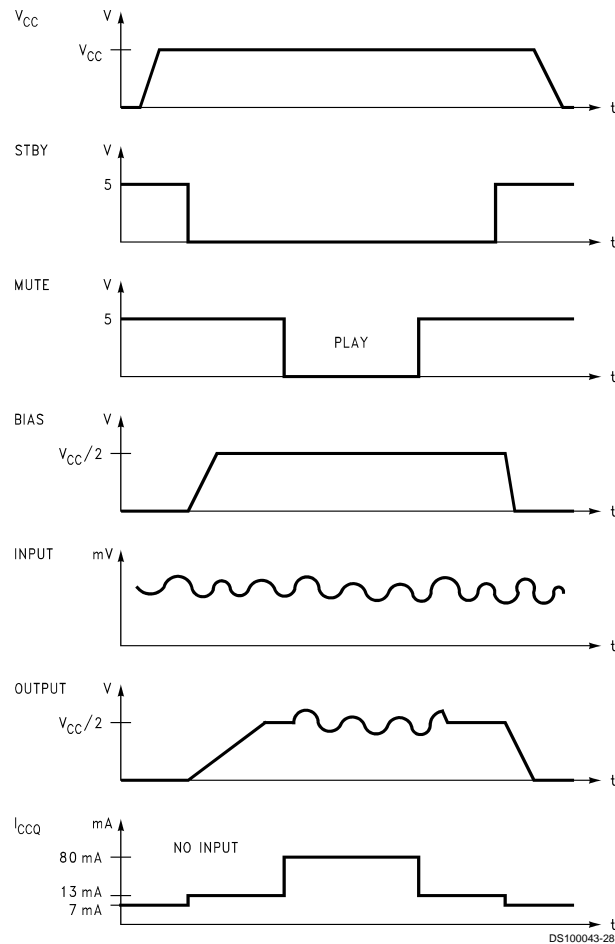

FIGURE 4. Turn-On/Off Sequence

If the sequence described above and shown in *Figure 4* is not used, then the external circuitry shown in *Figure 5* should be used to minimize turn-on/off pops and protect the output stage against SOA violations.

In *Figure 5* there are only a few components that are different than the ones described earlier for lowpass filtering the pin voltages. The new components are Q1, R2, R3, D1 and D2. All of the other components will perform the same functions that were previously described.

The explanation of how the circuit in *Figure 5* works will be related to the timing waveforms in *Figure 6*. The circuit in *Figure 5* protects the LM4753 from SOA violations by ensuring that the enabling of the standby function when music is playing will not quickly bring the biasing to ground before the input signal is smoothly attenuated through the volume function. Again, this is important because any quick changes in output current when driving an inductive load will cause a fly-back voltage that may damage the IC.

As shown in *Figure 6*, first notice that music is playing at the output. When the mechanical standby switch is toggled from

ground (play mode) to 5V (standby mode), transistor Q1 is quickly turned on, discharging capacitor C7, bringing the voltage at the volume pin, pin 3, to ground. This quickly attenuates the audio signal at the output as shown in *Figure 6*. While the input signal is being attenuated, the diode D1 becomes reverse biased and the voltage at the standby pin starts to charge through R4, C8 and C9. There is also a finite amount of current flowing through R5 as well, but because of its high resistance, we can neglect it in the charge-up timing of pin 9. Note that when the standby switch was grounded, the diode D1 was clamping the standby pin low, setting the initial voltage condition of C8 at a low voltage. Once C8 starts charging up, diode D2 becomes forward biased and C9 also starts charging up. This brings the standby and mute pin voltages up simultaneously. By the time the standby pin voltage enables the standby function, the voltage at the volume pin will already have been ramped down to 0V and the output signal will be close to 0V.

When the IC is in standby mode the biasing of the IC is brought down to ground and the quiescent supply current is around 7 mA. When the standby switch in *Figure 5* is toggled

Application Information (Continued)

to ground for play mode, transistor Q1 is quickly cut off and diode D1 is forward biased. When D1 is forward biased, capacitor C8 is quickly discharged to ground, bringing the standby pin voltage to 0V. When C8 is discharged, diode D2 becomes reverse biased allowing capacitor C9 to discharge to ground through R5. Diode D2 was clamping the voltage on C9 to the same voltage as C8. Because R5 is 10 times R4 it takes longer for the mute function to be disabled. While the mute voltage is decreasing, the biasing of the amplifier is charging up, since the standby function has already been disabled. While the mute voltage is decreasing the volume pin voltage is slowly increasing through the charge-up capacitor C7. Charging of the volume pin is from the 5V

through the volume control pot, R6 and C7. Notice that the time constant of the volume pin charging is greater than the mute pin discharging. As shown in *Figure 6*, the volume control function finally ramps up the input signal, allowing music to be amplified at the output.

Please notice that with this circuit the standby switch will override the mute switch as required in the IC's functional truth table in *Table 1*.

Also note once again that most systems typically utilize a microprocessor or COP microcontroller to interface with the logic control functions of the LM4753. When a clean logic signal is used, as from a microcontroller, RC lowpass filtering is not required for the mute and standby functions.

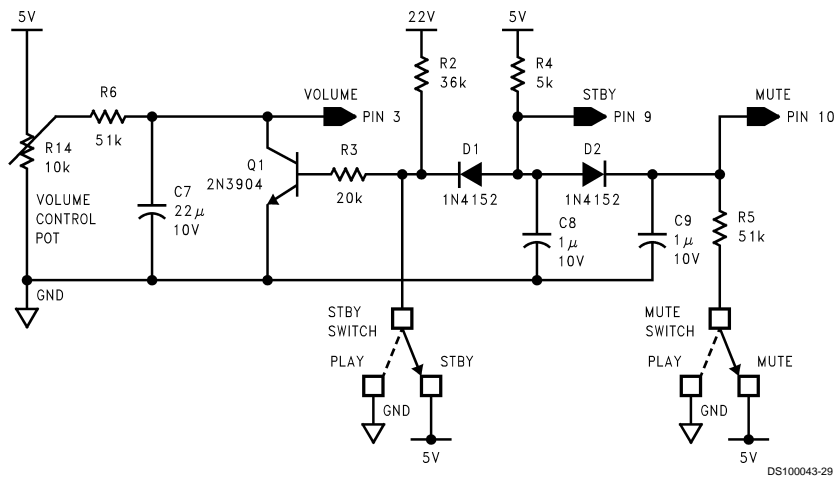

FIGURE 5. Turn-On/Off External Circuitry

Application Information (Continued)

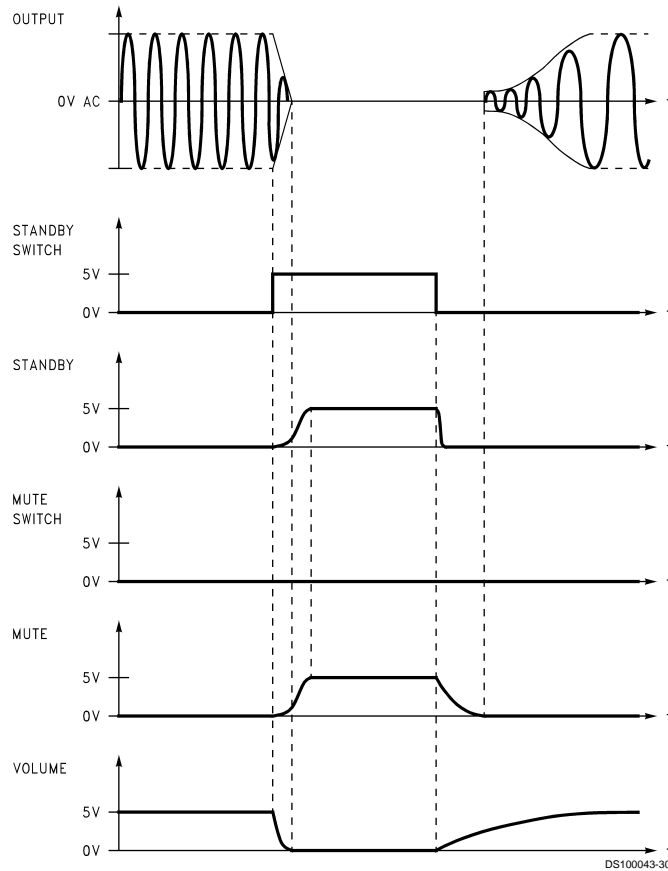

FIGURE 6. Turn-On/Off External Circuitry Sequence

Line Out

The line out function for the LM4753 is intended to provide preamp output control for signal routing to an external power amplifier. An example of this would be in a TV where the TV's remote control provides volume control on the audio signals that may be sent to a home theater receiver. The line out amplifier is only able to drive high impedance loads like 2 k Ω and 10 k Ω . Since the LM4753 utilizes a single +22V power supply, the output of the line out amplifier is biased at $\frac{1}{2}$ of V_{CC} or +11V. Because of this, its output should be capacitor coupled to any other processing IC. The value of the capacitor is chosen by using *Equation (1)*.

$$f = 1/2\pi RC \quad (1)$$

where R is the processing IC input impedance and f is the lowest audio frequency to be passed, like 20 Hz. The value of capacitance is then calculated. For a 10 k Ω impedance, C = 1 μ F.

AC Short Circuit Protection

The LM4753 is AC short circuit protected with a current limiting setting minimum of 2.0A. Current limiting protection works on AC waveforms only. DC shorts from the output to

ground are not protected. Generally this is not a concern as there is a DC blocking capacitor on the output to protect the speaker from single-supply DC bias.

Thermal Shutdown Protection

The LM4753 has a thermal shutdown protection scheme that limits the drive capability of each amplifier output when the internal die temperature reaches the temperature trip point of 150°C. The limiting of the output current drive capability is proportional to increasing die temperature.

When the IC is in thermal shutdown mode, all of the DC biases of the IC remain unchanged. It is only the current drive capability of the output power transistors that is limited. This thermal shutdown mechanism provides for smooth audio attenuation rather than abruptly pulling the outputs to ground. When the outputs are being limited, the maximum voltage swing will be reduced, creating a clipping effect as shown in *Figure 7*. With further increases in die temperature the maximum voltage swing will be further reduced.

The thermal sensing mechanism monitors the global die temperature and is not intended to operate quickly enough to shutdown the IC for extremely high power dissipation pulses created by driving very low impedance loads.

Application Information (Continued)

In *Figure 7*, a 50 kHz input signal is used to show the clipping and attenuating effect of the LM4753 when coming out of thermal shutdown.

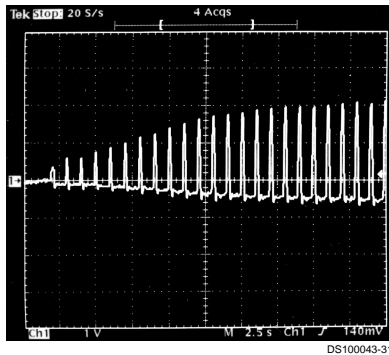

FIGURE 7. Thermal Shutdown Response

THERMAL CONSIDERATIONS

Determining Maximum Power Dissipation

It is important to determine the maximum amount of package power dissipation in order to choose an adequate heat sink. Improper heat sinking can lead to premature thermal shutdown operation, causing music to cut out. *Equation (2)* can be used to calculate the approximate maximum integrated circuit power dissipation for your amplifier design, given the supply voltage, and rated load, with both channels being driven simultaneously.

$$P_{DMAX} = 2(V_{CCtot})^2/2\pi^2R_L \quad (2)$$

To ensure that a proper heat sink is chosen, be sure to take into account the effects of the unregulated power supply voltage variation and the highly reactive load impedance variation over frequency.

A poorly regulated power supply can have a supply voltage variation of more than 10V. Be sure to take into account the no-load power supply voltage.

A nominally rated 8Ω load can have an impedance dip down to 5Ω at low frequencies. As well, the load is not purely resistive, and this causes the amplifier output current to be out of phase with the output voltage. When the current and voltage are out of phase, the internal power dissipation actually increases.

Equation (2) can be directly applied to the Power Dissipation vs Output Power curves in the Typical Performance Characteristics section. However, the curves take into account quiescent power dissipation which *Equation (2)* does not. The curves are to be used as a guideline in determining the required heat sink and are not intended to provide exact power dissipation values.

Heat Sinking

Choosing a heat sink for a high-power audio amplifier is made entirely to keep the die temperature below its maximum junction temperature, so that the thermal protection circuitry does not operate under normal circumstances. The heat sink should be chosen to dissipate the maximum IC power for the maximum no-load supply voltage and the minimum load impedance.

Referring to *Figure 8*, the thermal resistance from the die (junction) to the outside air (ambient) is a combination of three thermal resistances, θ_{JC} , θ_{CS} and θ_{SA} . Two of these thermal resistances are provided by National, θ_{JC} and θ_{CS} .

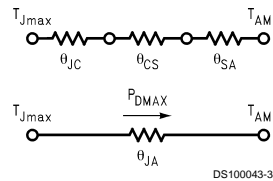

FIGURE 8. Thermal Model

Since convection heat flow (power dissipation) is analogous to current flow, thermal resistance is analogous to electrical resistance, and temperature drops are analogous to voltage drops, the power dissipation out of the LM4753 is equal to the following:

$$P_{DMAX} = (T_{JMAX} - T_{AMB})/\theta_{JA} \quad (3)$$

The thermal resistance, θ_{JA} is equal to $\theta_{JC} + \theta_{CS} + \theta_{SA}$, where θ_{JC} is the junction-to-case thermal resistance, θ_{CS} is the case-to-sink thermal resistance (thermal compound), and θ_{SA} is the sink-to-ambient thermal resistance.

Once the maximum power dissipation is calculated from *Equation (2)* above, the minimum heat sink thermal resistance can be calculated from *Equation (4)* below.

$$\theta_{SA} = [(T_{JMAX} - T_{AMB}) - P_{DMAX}(\theta_{JC} + \theta_{CS})]/P_{DMAX} \quad (4)$$

Example:

$$V_{CC} = +22V$$

$$R_L = 8\Omega$$

$$\theta_{JC} = 1^\circ C/W$$

$$\theta_{CS} = 0.5^\circ C/W$$

$$(1) P_{DMAX} = 2((22V)^2/2\pi^2(8\Omega)) = 6W$$

$$(2) \theta_{SA} = [(150^\circ C - 25^\circ C) - 6W(1^\circ C/W + 0.5^\circ C/W)]/6W = 19^\circ C/W$$

Therefore, the minimum heat sink thermal resistance required is 19°C/W for both channels being driven simultaneously at maximum power dissipation into an 8Ω load using a +22V voltage supply. Again, remember to take into account the unregulated supply voltage and reactive load impedance dips.

Should it be necessary to isolate the tab of the IC from the heat sink, an insulating washer can be used. There are many different types of insulating washers with varying thermal resistances. Good washers can be obtained from Thermalloy or Berquist. Refer to the References list for contact information for these manufacturers.

Supply Bypassing

The LM4753 has good power supply rejection, however, for all power amplifiers, proper power supply bypassing is required. To prevent oscillations and instability, all op amps and power op amps should have their supply leads bypassed with low-inductance capacitors having short leads. All high frequency bypass capacitors should be located as close to the package terminals as possible and have a clear unobstructed current return path to ground. It is typical to use capacitor values that are a factor of 100 different from each other to minimize interaction with each other. The LM4753 should be bypassed with 0.1 μF ceramic and 100 μF tantalum capacitors for optimum performance. The 100 μF tantalum can be replaced with an electrolytic, but the bypassing

Application Information (Continued)

performance of the tantalum will be better. There should also be large supply reservoir capacitors of about 4700 μF on each supply rail. A larger reservoir capacitor will reduce the supply ripple and will supply larger current burst requirements instead of requiring those large currents to come from the main power supply transformer.

If adequate bypassing is not provided, the current in the supply leads, which is a rectified component of the load current, may be fed back into internal circuitry. This signal may cause signal distortion to increase.

Layout and Ground Loops

When designing a printed circuit board layout, it is important to return the load ground, any output compensation ground, and the low-level (feedback and input) grounds to the circuit board common ground point through separate paths. Large currents flowing along a ground conductor will generate voltages which effectively act as signals to the input ground ref-

erence. This can result in high frequency oscillation or excessive distortion. Output compensation components and the high frequency supply bypass capacitors should be placed as close as possible to the IC to reduce the effects of PCB trace resistance and inductance. For cases where long traces must exist, widen the traces to minimize their inductance.

References

International Electronic Research Corporation
P.O. Box 7704,

Burbank, California 91510-7704,
(818) 842-7277

Thermalloy Inc.

P.O. Box 810839,
Dallas, Tx 75381-0839,
(214) 243-4321,
www.thermalloy.com

Physical Dimensions inches (millimeters) unless otherwise noted

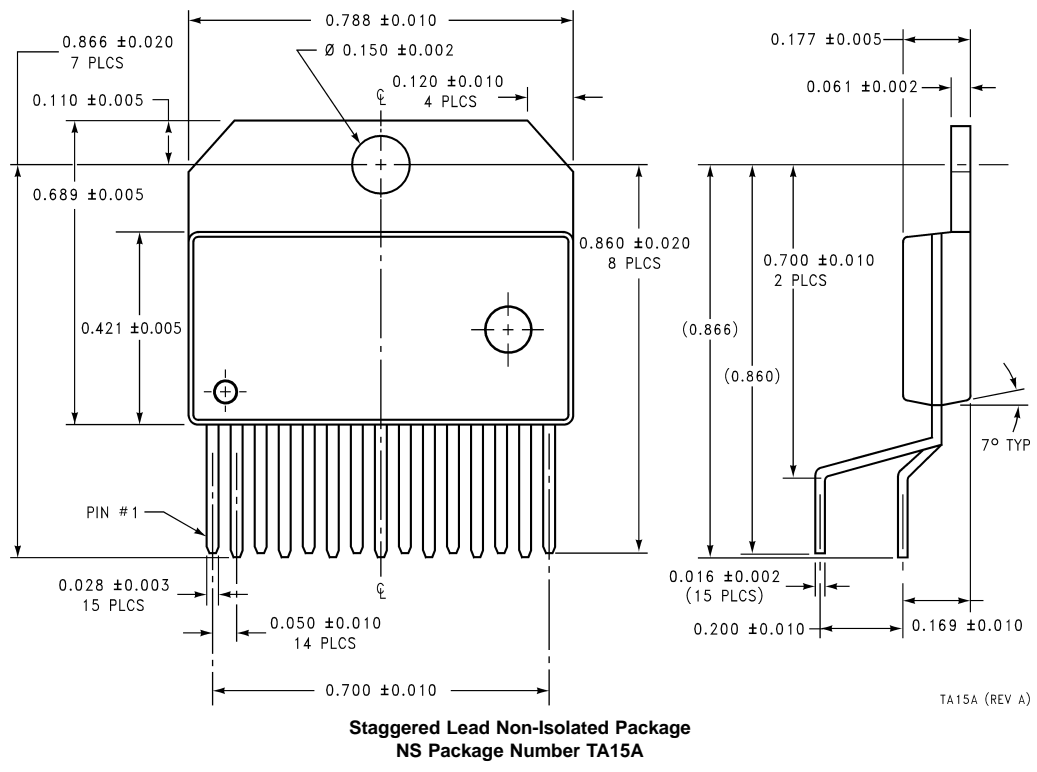

LIFE SUPPORT POLICY

NATIONAL'S PRODUCTS ARE NOT AUTHORIZED FOR USE AS CRITICAL COMPONENTS IN LIFE SUPPORT DEVICES OR SYSTEMS WITHOUT THE EXPRESS WRITTEN APPROVAL OF THE PRESIDENT AND GENERAL COUNSEL OF NATIONAL SEMICONDUCTOR CORPORATION. As used herein:

1. Life support devices or systems are devices or systems which, (a) are intended for surgical implant into the body, or (b) support or sustain life, and whose failure to perform when properly used in accordance with instructions for use provided in the labeling, can be reasonably expected to result in a significant injury to the user.
2. A critical component is any component of a life support device or system whose failure to perform can be reasonably expected to cause the failure of the life support device or system, or to affect its safety or effectiveness.

<p>National Semiconductor Corporation Americas Tel: 1-800-272-9959 Fax: 1-800-737-7018 Email: support@nsc.com www.national.com</p>	<p>National Semiconductor Europe Fax: +49 (0) 1 80-530 85 86 Email: europe.support@nsc.com Deutsch Tel: +49 (0) 1 80-530 85 85 English Tel: +49 (0) 1 80-532 78 32 Français Tel: +49 (0) 1 80-532 93 58 Italiano Tel: +49 (0) 1 80-534 16 80</p>	<p>National Semiconductor Asia Pacific Customer Response Group Tel: 65-2544466 Fax: 65-2504466 Email: sea.support@nsc.com</p>	<p>National Semiconductor Japan Ltd. Tel: 81-3-5639-7560 Fax: 81-3-5639-7507</p>
--	---	--	---

National does not assume any responsibility for use of any circuitry described, no circuit patent licenses are implied and National reserves the right at any time without notice to change said circuitry and specifications.