



	ITC117P	Units
Relay Load Voltage	350	V
Relay Load Current	120	mA
Relay Max R <sub>ON</sub>	15	Ω
Bridge Rectifier Reverse Voltage	100	V
Darlington Collector Current	120	mA
Darlington Current Gain	10,000	-

### Description

The Integrated Telecom Circuit combines a 1-Form-A solid state relay, bridge rectifier, Darlington transistor and opto-coupler into one 16 pin SOIC package, consolidating designs and reducing component count in telecom applications. The ITC117's optocoupler provides for full wave detection of ring signals.

### Features

- Small 16 Pin SOIC Package (PCMCIA Compatible)
- Board Space and Cost Savings
- 2mW Hookswitch Drive Power (Logic Compatible)
- No Moving Parts
- 3750V<sub>RMS</sub> Input/Output Isolation
- FCC Compatible Part 68
- Full-Wave Bridge Rectifier
- Darlington Transistor for Electronic Inductor "Dry" Circuits
- Full Wave Current Detector for Ring Signal or Loop Current Detect
- JEDEC Standard Pin Out

### Approvals

- UL Recognized: File Number E76270
- CSA Certified: File Number LR 43639-12
- BSI Certified:
  - BS EN 60950:1992 (BS7002:1992) Certificate #: 7969
  - BS EN 41003:1993 Certificate #: 7969

### Ordering Information

Part #	Description
ITC117P	16 Pin SOIC (50/Tube)
ITC117P	16 Pin SOIC (1000/Reel)

### Applications

- Data/Fax Modem
- Voice Mail Systems
- Telephone Sets
- Computer Telephony Integration
- Set Top Box Modems

### Pin Configuration

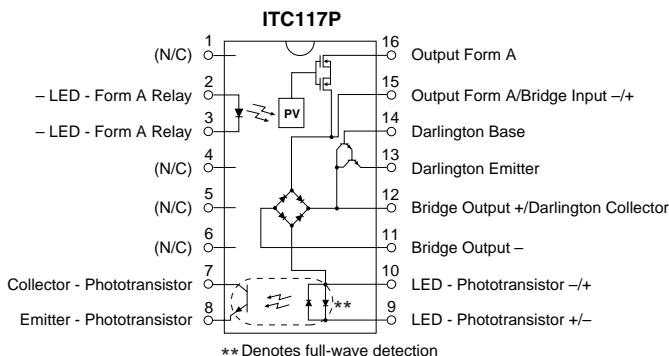

### Absolute Maximum Ratings (@ 25° C)

Parameter	Min	Typ	Max	Units
Total Package Dissipation	-	-	1 <sup>1</sup>	W
Isolation Voltage				
Input to Output	3750	-	-	V <sub>RMS</sub>
Operational Temperature	-40	-	+85	°C
Storage Temperature	-40	-	+125	°C
Soldering Temperature (10 Seconds Max.)	-	-	+220	°C

<sup>1</sup> Above 25° derate linearly 8.33mw/°C

Total Power Dissipation (PD):

$$P_D = P_{\text{HOOKSWITCH}} + P_{\text{BRIDGE}} + P_{\text{DARLINGTON}} + P_{\text{LED}}$$

$$P_D = (R_{DS(on)})(I_L^2) + 2(V_F)(I_L) + (V_{CE})(I_L) + (V_{LED})(I_F)$$

WHERE:

$R_{DS(on)}$  = Maximum reoly on resistance

$I_L$  = Maximum loop current

$V_F$  = Maximum diode forward voltage

$V_{CE}$  = Maximum voltage collector to emitter

$V_{LED}$  = Maximum LED forward voltage

$I_F$  = Maximum LED current

*Absolute Maximum Ratings are stress ratings. Stresses in excess of these ratings can cause permanent damage to the device. Functional operation of the device at these or any other conditions beyond those indicated in the operational sections of this data sheet is not implied. Exposure of the device to the absolute maximum ratings for an extended period may degrade the device and effect its reliability.*

### Electrical Characteristics

Parameter	Conditions	Symbol	Min	Typ	Max	Units
<b>Relay Portion (Pins 15,16)</b>						
<b>Output Characteristics @ 25°C</b>						
Load Voltage, DC or Peak AC	-	$V_L$	-	-	350	V
Load Current (Continuous)	-	$I_L$	-	-	120	mA
On-Resistance	$I_L=120\text{mA}$	$R_{ON}$	-	-	15	$\Omega$
Off-State Leakage Current	$V_L=350, T_J=25^\circ\text{C}$	$I_{LEAK}$	-	-	1	$\mu\text{A}$
Switching Speeds						
Turn-On	$I_F=5\text{mA}, V_L=10\text{V}$	$T_{ON}$	-	-	3	ms
Turn-Off	$I_F=5\text{mA}, V_L=10\text{V}$	$T_{OFF}$	-	-	3	ms
Output Capacitance	50V, f=1MHz	$C_{OUT}$	-	25	-	pF
<b>Relay Portion (Pins 2,3)</b>						
<b>Input Characteristics @ 25°C</b>						
Input Control Current	$I_L=120\text{mA}$	$I_F$	5	-	50	mA
Input Voltage Drop	$I_F=5\text{mA}$	$V_F$	0.9	1.2	1.4	V
Reverse Input Voltage	-	$V_R$	-	-	5	V
Reverse Input Current	$V_R=5\text{V}$	$I_R$	-	-	10	$\mu\text{A}$
<b>Detector Portion (Pins 7,8)</b>						
<b>Output Characteristics @ 25°C</b>						
Phototransistor Blocking Voltage	$I_C=10\mu\text{A}$	$BV_{CEO}$	20	50	-	V
Phototransistor Dark Current	$V_{CE}=5\text{V}, I_F=0\text{mA}$	$I_{CEO}$	-	50	500	A
Saturation Voltage	$I_C=2\text{mA}, I_F=16\text{mA}$	$V_{SAT}$	-	0.3	0.5	V
Current Transfer Ratio	$I_F=6\text{mA}, V_{CE}=0.5\text{V}$	CTR	33	400	-	%
<b>Detector Portion (Pins 9,10)</b>						
<b>Input Characteristics @ 25°C</b>						
Input Control Current	$I_C=2\text{mA}, V_{CE}=0.5\text{V}$	$I_F$	6	2	100	mA
Input Voltage Drop	$I_F=5\text{mA}$	$V_F$	0.9	1.2	1.4	V
Input Current (Detector must be off)	$I_C=1\mu\text{A}, V_{CE}=5\text{V}$	$I_F$	5	25	-	$\mu\text{A}$

**Electrical Characteristics**

Parameter	Conditions	Symbol	Min	Typ	Max	Units
<b>Bridge Rectifier Electrical Ratings @ 25°C</b>						
Reverse Voltage	-	$V_{RD}$	-	-	100	V
Forward Drop Voltage	$I_{FD}=120\text{mA}$	$V_{FD}$	-	-	1.5	V
Reverse Leakage Current	$T_J=25^\circ\text{C}, V_R=100\text{V}$ $T_J=85^\circ\text{C}$	$I_{RD}$	-	-	10	$\mu\text{A}$
Forward Current (Continuous)		$I_{FD}$	-	-	140	mA
Forward Current (Peak)	$t=10\text{mS}$	$I_{FD}$	-	-	0.5	A
<b>Darlington Electrical Ratings @ 25°C</b>						
Collector-Emitter Voltage	$I_C=10\text{mA DC}, I_B=0$	$V_{CEO}$	40	-	-	V
Collector-Current Continuous	$V_C=3.5\text{V}$	$I_C$	-	-	120	mA
Power Dissipation @ 25°C	-	$P_d$	-	-	500	mW
Off-State Collector Emitter Leakage Current	$V_{CE}=10\text{V}; I_B=0\text{mA}$	$I_{CEX}$	-	-	1	$\mu\text{A}$
DC Current Gain	$I_C=120\text{mA},$ $V_{CE}=10\text{VDC}$	$h_{FE}$	10,000	-	-	
Saturation Voltage	$I_C=120\text{mA}$	$V_{CE(SAT)}$	-	-	1.5	V
Total Harmonic Distortion	$f_o=300\text{Hz @ -10dBm}$ $I_C=40\text{mA}$	-	-	-	-80	dB
<b>Zener Characteristics @ 25°C</b>						
Zener Voltage (Between pins 4+5 and 6+5)	$I_{ZT}=20\text{mA}$	$V_Z$	-	-	-	V
Zener Voltage (Between pins 12+11)	$I_{ZT}=20\text{mA}$	$V_Z$	-	-	-	V
Input to Output Capacitance	-	$C_{I/O}$	-	3	-	pF
Input to Output Isolation	-	$V_{I/O}$	3750	-	-	$V_{RMS}$

PERFORMANCE DATA\*

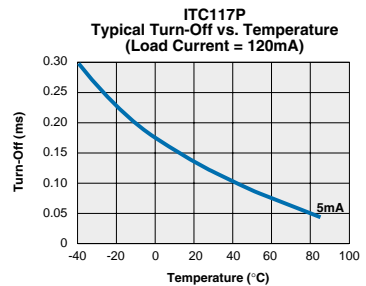
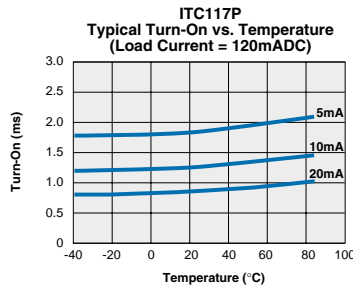
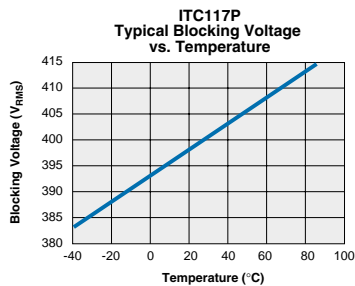
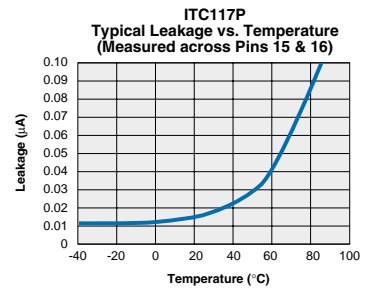
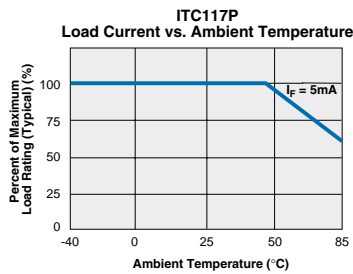
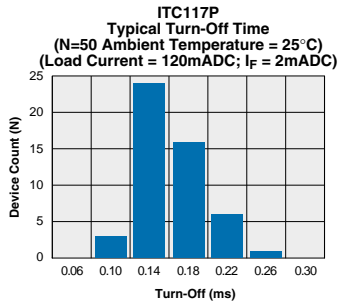
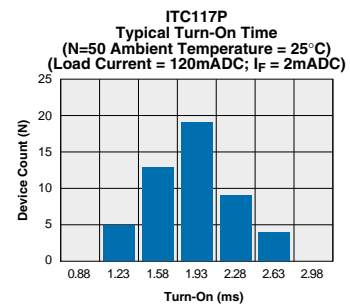
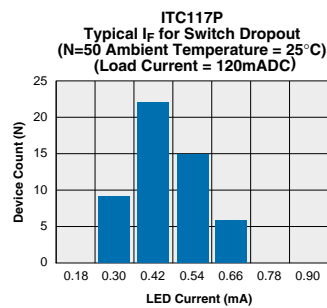
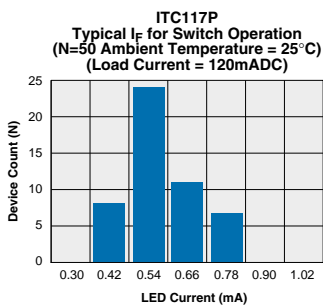
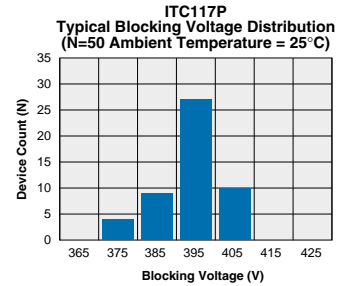
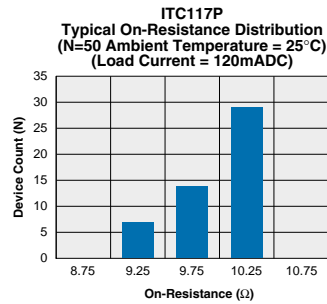
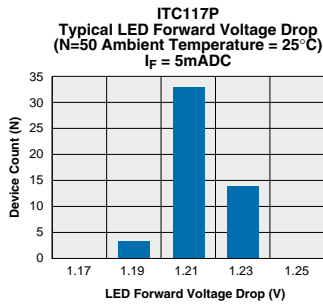

The Performance data shown in the graphs above is typical of device performance. For guaranteed parameters not indicated in the written specifications, please contact our application department.

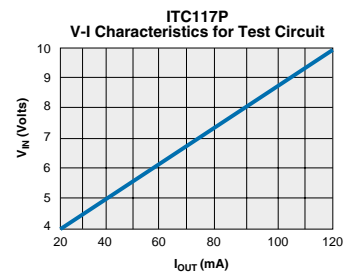
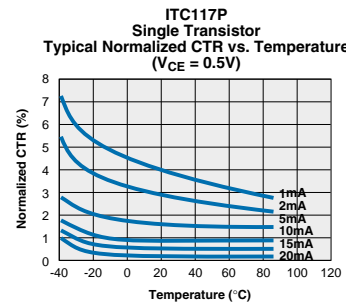
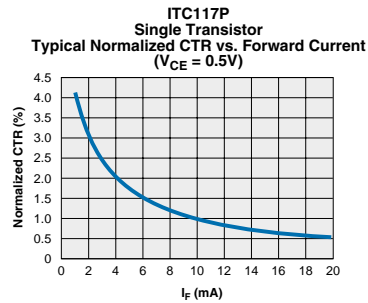
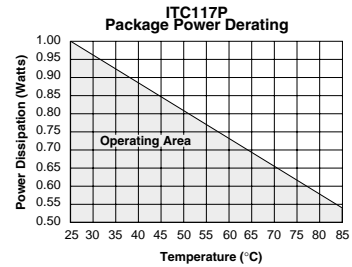
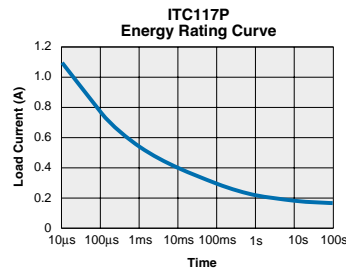
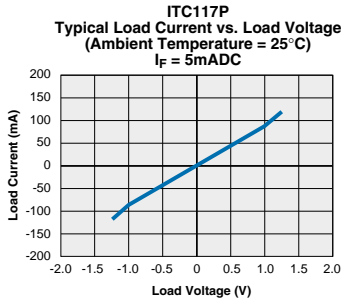
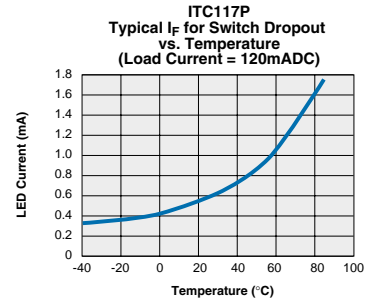
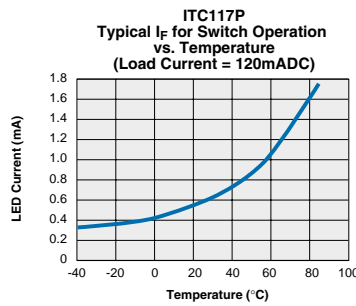
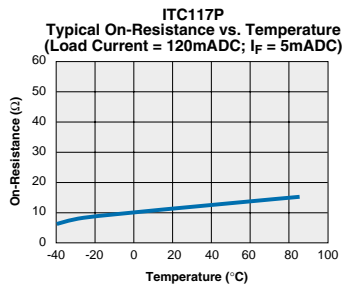
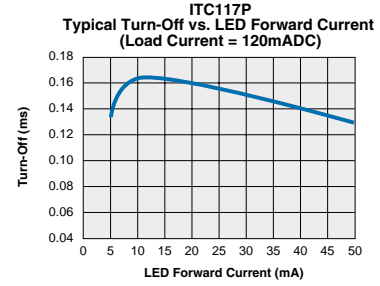
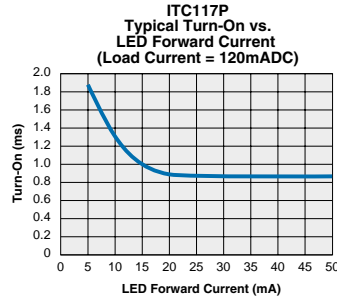
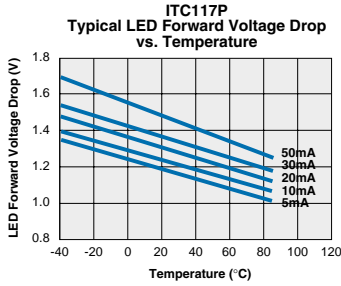
**PERFORMANCE DATA\***

\*The Performance data shown in the graphs above is typical of device performance. For guaranteed parameters not indicated in the written specifications, please contact our application department.

PERFORMANCE DATA\*

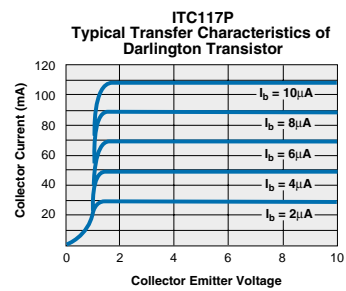
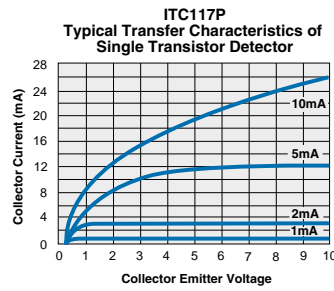
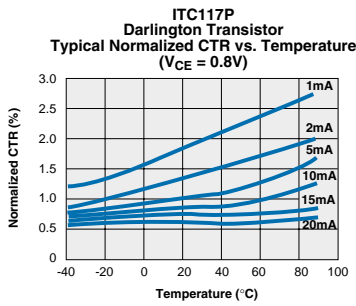
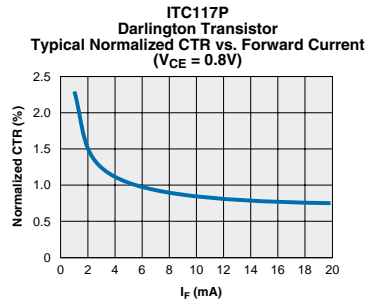
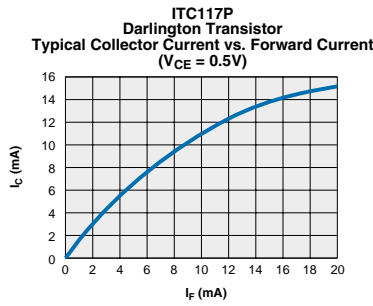
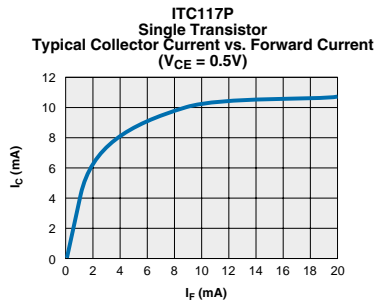

\*The Performance data shown in the graphs above is typical of device performance. For guaranteed parameters not indicated in the written specifications, please contact our application department.

Mechanical Dimensions

16 Pin SOIC ("P" Suffix)

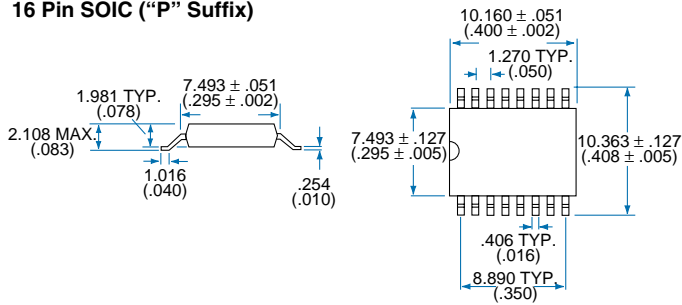

PC Board Pattern (Top View)

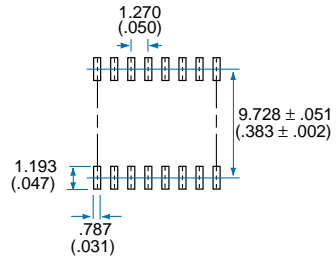

Tape and Reel Packaging for 16 Pin SOIC Package

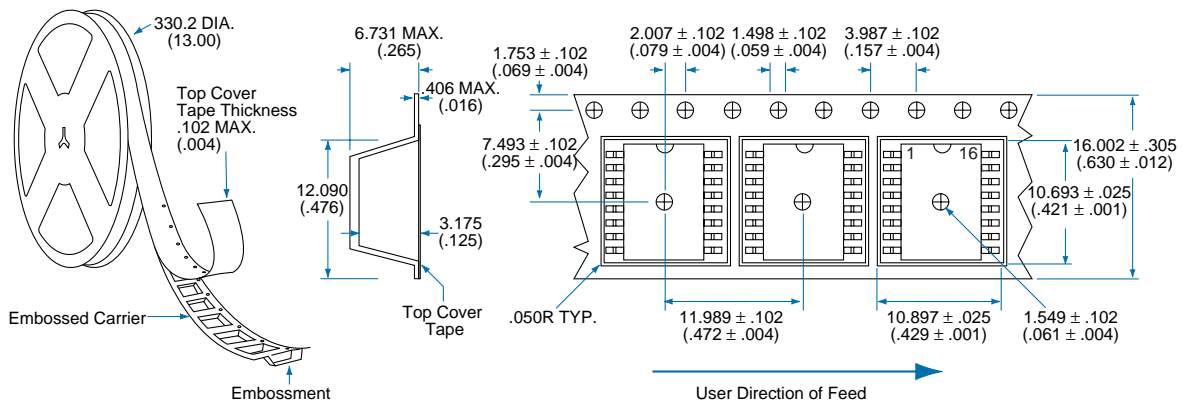

Dimensions  
mm  
(inches)



# CLARE

---

**For additional information please visit our website at: [www.clare.com](http://www.clare.com)**

*Clare, Inc. makes no representations or warranties with respect to the accuracy or completeness of the contents of this publication and reserves the right to make changes to specifications and product descriptions at any time without notice. Neither circuit patent licenses nor indemnity are expressed or implied. Except as set forth in Clare's Standard Terms and Conditions of Sale, Clare, Inc. assumes no liability whatsoever, and disclaims any express or implied warranty, relating to its products including, but not limited to, the implied warranty of merchantability, fitness for a particular purpose, or infringement of any intellectual property right.*

*The products described in this document are not designed, intended, authorized or warranted for use as components in systems intended for surgical implant into the body, or in other applications intended to support or sustain life, or where malfunction of Clare's product may result in direct physical harm, injury, or death to a person or severe property or environmental damage. Clare, Inc. reserves the right to discontinue or make changes to its products at any time without notice.*

Specification: DS-ITC117P-RXX  
©Copyright 2002, Clare, Inc.  
All rights reserved. Printed in USA.  
6/25/02