

DS90CP22

800 Mbps 2x2 LVDS Crosspoint Switch

General Description

DS90CP22 is a 2x2 crosspoint switch utilizing LVDS (Low Voltage Differential Signaling) technology for low power, high speed operation. Data paths are fully differential from input to output for low noise generation and low pulse width distortion. The non-blocking design allows connection of any input to any output or outputs. LVDS I/O enable high speed data transmission for point-to-point interconnects. This device can be used as a high speed differential crosspoint, 2:1 mux, 1:2 demux, repeater or 1:2 signal splitter. The mux and demux functions are useful for switching between primary and backup circuits in fault tolerant systems. The 1:2 signal splitter and 2:1 mux functions are useful for distribution of serial bus across several rack-mounted backplanes.

The DS90CP22 accepts LVDS signal levels, LVPECL levels directly or PECL with attenuation networks.

The individual LVDS outputs can be put into TRI-STATE by use of the enable pins.

For more details, please refer to the Application Information section of this datasheet.

Features

- DC - 800 Mbps low jitter, low skew operation
- 65 ps (typ) of pk-pk jitter with PRBS = $2^{23}-1$ data pattern at 800 Mbps
- Single +3.3 V Supply
- Less than 330 mW (typ) total power dissipation
- Non-blocking "Switch Architecture"
- Balanced output impedance
- Output channel-to-channel skew is 35 ps (typ)
- Configurable as 2:1 mux, 1:2 demux, repeater or 1:2 signal splitter
- LVDS receiver inputs accept LVPECL signals
- Fast switch time of 1.2ns (typ)
- Fast propagation delay of 1.3ns (typ)
- Receiver input threshold $< \pm 100$ mV
- Available in 16 lead TSSOP and SOIC packages
- Conforms to ANSI/TIA/EIA-644-1995 LVDS standard
- Operating Temperature: -40°C to $+85^{\circ}\text{C}$

Connection Diagrams

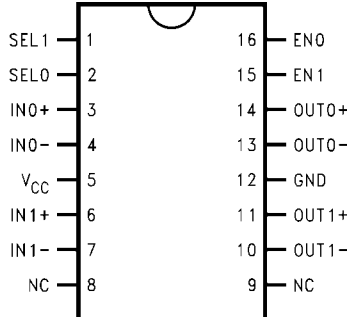

10105305
 Order Number DS90CP22M-8 (SOIC)
 Order Number DS90CP22MT (TSSOP)

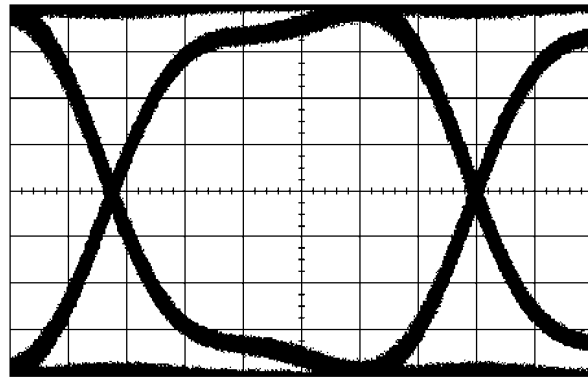

10105310
 Diff. Output Eye-Pattern in 1:2 split mode @ 800 Mbps
 Conditions: 3.3 V, PRBS = $2^{23}-1$ data pattern,
 $V_{ID} = 300\text{mV}$, $V_{CM} = +1.2$ V, 200 ps/div, 100 mV/div

Absolute Maximum Ratings (Note 1)

If Military/Aerospace specified devices are required, please contact the National Semiconductor Sales Office/ Distributors for availability and specifications.

Supply Voltage (V_{CC})	-0.3V to +4V
CMOS/TTL Input Voltage (EN0, EN1, SEL0, SEL1)	-0.3V to ($V_{CC} + 0.3V$)
LVDS Receiver Input Voltage (IN+, IN-)	-0.3V to +4V
LVDS Driver Output Voltage (OUT+, OUT-)	-0.3V to +4V
LVDS Output Short Circuit Current	Continuous
Junction Temperature	+150°C
Storage Temperature Range	-65°C to +150°C
Lead Temperature (Soldering, 4 sec.)	+260°C

Maximum Package Power Dissipation at 25°C

16L SOIC	1.435 W
16L SOIC Package Derating	11.48 mW/°C above +25°C
16L TSSOP	0.866 W
16L TSSOP Package Derating	9.6 mW/°C above +25°C
ESD Rating:	
(HBM, 1.5k Ω , 100pF)	> 5 kV
(EIAJ, 0 Ω , 200pF)	> 250 V

Recommended Operating Conditions

	Min	Typ	Max	Units
Supply Voltage (V_{CC})	3.0	3.3	3.6	V
Receiver Input Voltage	0		V_{CC}	V
Operating Free Air Temperature	-40	+25	+85	°C

Electrical Characteristics

Over recommended operating supply and temperature ranges unless otherwise specified

Symbol	Parameter	Conditions	Min	Typ	Max	Units
CMOS/TTL DC SPECIFICATIONS (EN0,EN1,SEL0,SEL1)						
V_{IH}	High Level Input Voltage		2.0		V_{CC}	V
V_{IL}	Low Level Input Voltage		GND		0.8	V
I_{IH}	High Level Input Current	$V_{IN} = 3.6V$ or $2.0V$; $V_{CC} = 3.6V$		+7	+20	μA
I_{IL}	Low Level Input Current	$V_{IN} = 0V$ or $0.8V$; $V_{CC} = 3.6V$		± 1	± 10	μA
V_{CL}	Input Clamp Voltage	$I_{CL} = -18$ mA		-0.8	-1.5	V
LVDS OUTPUT DC SPECIFICATIONS (OUT0,OUT1)						
V_{OD}	Differential Output Voltage	$R_L = 75\Omega$	270	365	475	mV
		$R_L = 75\Omega$, $V_{CC} = 3.3V$, $T_A = 25^\circ C$	285	365	440	mV
ΔV_{OD}	Change in V_{OD} between Complimentary Output States				35	mV
V_{OS}	Offset Voltage (Note 3)		1.0	1.2	1.45	V
ΔV_{OS}	Change in V_{OS} between Complimentary Output States				35	mV
I_{OZ}	Output TRI-STATE® Current	TRI-STATE Output, $V_{OUT} = V_{CC}$ or GND		± 1	± 10	μA
I_{OFF}	Power-Off Leakage Current	$V_{CC} = 0V$; $V_{OUT} = 3.6V$ or GND		± 1	± 10	μA
I_{OS}	Output Short Circuit Current	V_{OUT+} OR $V_{OUT-} = 0V$		-15	-25	mA
I_{OSB}	Both Outputs Short Circuit Current	V_{OUT+} AND $V_{OUT-} = 0V$		-30	-50	mA
LVDS RECEIVER DC SPECIFICATIONS (IN0,IN1)						
V_{TH}	Differential Input High Threshold	$V_{CM} = +0.05V$ or $+1.2V$ or $+3.25V$, $V_{CC} = 3.3V$		0	+100	mV
V_{TL}	Differential Input Low Threshold		-100	0		mV
V_{CMR}	Common Mode Voltage Range	$V_{ID} = 100mV$, $V_{CC} = 3.3V$	0.05		3.25	V
I_{IN}	Input Current	$V_{IN} = +3.0V$, $V_{CC} = 3.6V$ or $0V$		± 1	± 10	μA
		$V_{IN} = 0V$, $V_{CC} = 3.6V$ or $0V$		± 1	± 10	μA
SUPPLY CURRENT						
I_{CCD}	Total Supply Current	$R_L = 75\Omega$, $C_L = 5$ pF, EN0 = EN1 = High		98	125	mA
I_{CCZ}	TRI-STATE Supply Current	EN0 = EN1 = Low		43	55	mA

Note 1: "Absolute Maximum Ratings" are those beyond which the safety of the device cannot be guaranteed. They are not meant to imply that the device should be operated at these limits. The table of "Electrical Characteristics" provides conditions for actual device operation.

Note 2: All typical are given for $V_{CC} = +3.3V$ and $T_A = +25^\circ C$, unless otherwise stated.

Note 3: V_{OS} is defined and measured on the ATE as $(V_{OH} + V_{OL}) / 2$.

AC Electrical Characteristics

Over recommended operating supply and temperature ranges unless otherwise specified (Note 4)

Symbol	Parameter	Conditions	Min	Typ	Max	Units
T_{SET}	Input to SEL Setup Time, <i>Figures 1, 2</i> (Note 5)		0.7	0.5		ns
T_{HOLD}	Input to SEL Hold Time, <i>Figures 1, 2</i> (Note 5)		1.0	0.5		ns
T_{SWITCH}	SEL to Switched Output, <i>Figures 1, 2</i>		0.9	1.2	1.7	ns
T_{PHZ}	Disable Time (Active to TRI-STATE) High to Z, <i>Figure 3</i>			2.1	4.0	ns
T_{PLZ}	Disable Time (Active to TRI-STATE) Low to Z, <i>Figure 3</i>			3.0	4.5	ns
T_{PZH}	Enable Time (TRI-STATE to Active) Z to High, <i>Figure 3</i>			25.5	55.0	ns
T_{PZL}	Enable Time (TRI-STATE to Active) Z to Low, <i>Figure 3</i>			25.5	55.0	ns
T_{LHT}	Output Low-to-High Transition Time, 20% to 80%, <i>Figure 5</i>		290	400	580	ps
T_{HLT}	Output High-to-Low Transition Time, 80% to 20%, <i>Figure 5</i>		290	400	580	ps
T_{JIT}	LVDS Data Path Peak to Peak Jitter, (Note 6)	$V_{ID} = 300\text{mV}$; 50% Duty Cycle; $V_{CM} = 1.2\text{V}$ at 800Mbps		40	90	ps
		$V_{ID} = 300\text{mV}$; PRBS=2 ²³ -1 data pattern; $V_{CM} = 1.2\text{V}$ at 800Mbps		65	120	ps
T_{PLHD}	Propagation Low to High Delay, <i>Figure 6</i>		0.9	1.3	1.6	ns
	Propagation Low to High Delay, <i>Figure 6</i>	$V_{CC} = 3.3\text{V}$, $T_A = 25^\circ\text{C}$	1.0	1.3	1.5	ns
T_{PHLD}	Propagation High to Low Delay, <i>Figure 6</i>		0.9	1.3	1.6	ns
	Propagation High to Low Delay, <i>Figure 6</i>	$V_{CC} = 3.3\text{V}$, $T_A = 25^\circ\text{C}$	1.0	1.3	1.5	ns
T_{SKEW}	Pulse Skew $ T_{PLHD} - T_{PHLD} $			0	225	ps
T_{CCS}	Output Channel-to-Channel Skew, <i>Figure 7</i>			35	80	ps

Note 4: The parameters are guaranteed by design. The limits are based on statistical analysis of the device performance over PVT (process, voltage and temperature) range.

Note 5: T_{SET} and T_{HOLD} time specify that data must be in a stable state before and after the SEL transition.

Note 6: The parameters are guaranteed by design. The limits are based on statistical analysis of the device performance over PVT range with the following equipment test setup: HP70004A (display mainframe) with HP70841B (pattern generator), 5 feet of RG-142 cable with DUT test board and HP83480A (digital scope mainframe) with HP83483A (20GHz scope module).

AC Timing Diagrams

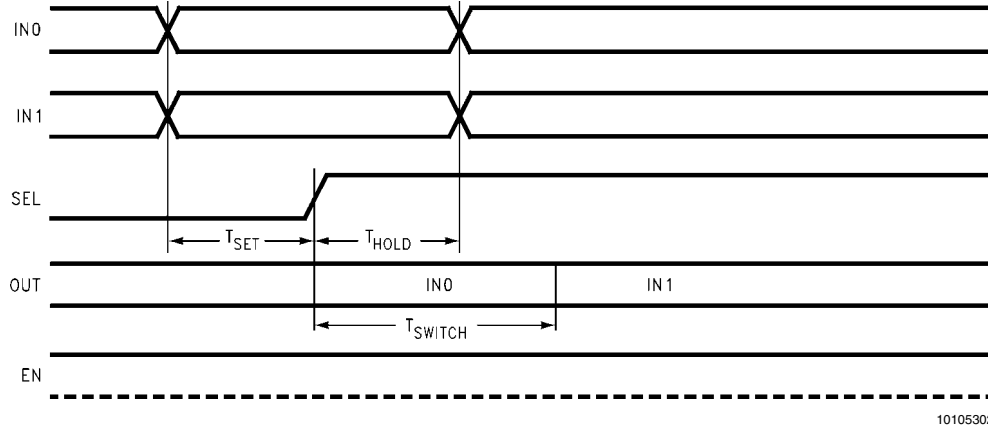

10105302

FIGURE 1. Input-to-Select rising edge setup and hold times and mux switch time

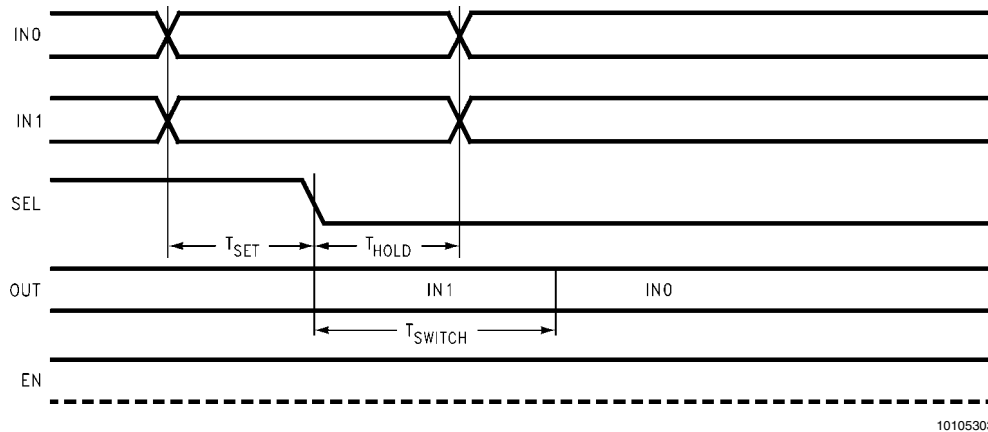

10105303

FIGURE 2. Input-to-Select falling edge setup and hold times and mux switch time

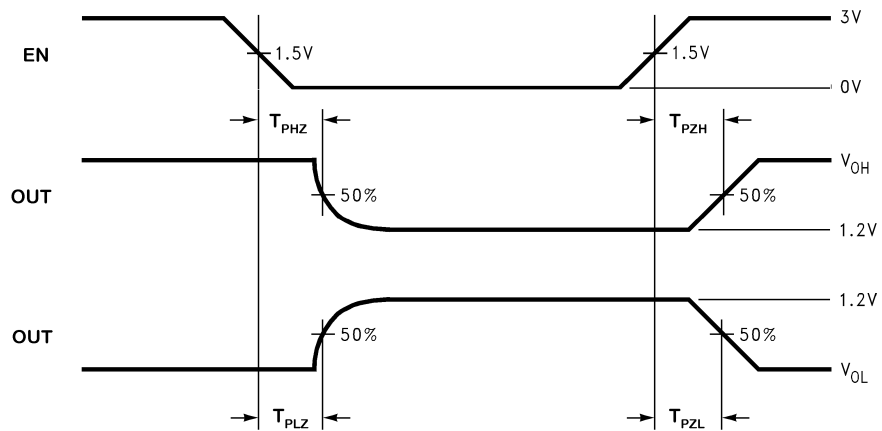

10105304

FIGURE 3. Output active to TRI-STATE and TRI-STATE to active output time

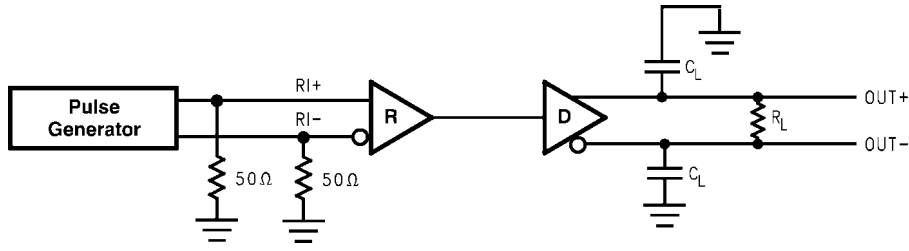

10105306

FIGURE 4. LVDS Output Load

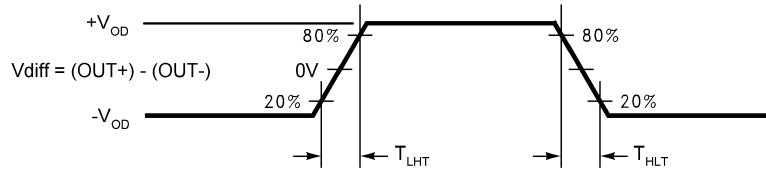

10105309

FIGURE 5. LVDS Output Transition Time

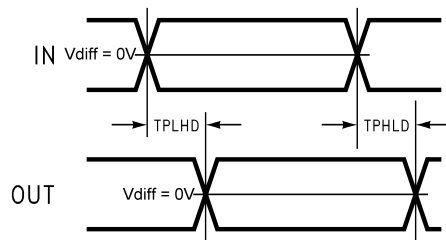

10105307

FIGURE 6. Propagation Delay Low-to-High and High-to-Low

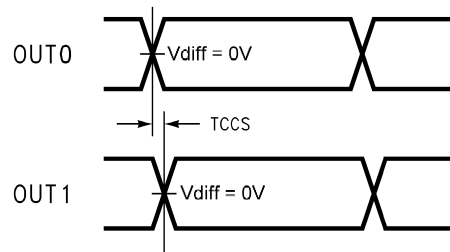

10105308

FIGURE 7. Output Channel-to-Channel Skew in 1:2 splitter mode

DS90CP22 Pin Descriptions

Pin Name	# of Pin	Input/Output	Description
IN+	2	I	Non-inverting LVDS input
IN -	2	I	Inverting LVDS input
OUT+	2	O	Non-inverting LVDS Output
OUT -	2	O	Inverting LVDS Output
EN	2	I	A logic low on the Enable puts the LVDS output into TRI-STATE and reduces the supply current
SEL	2	I	2:1 mux input select
GND	1	P	Ground
V _{CC}	1	P	Power Supply
NC	2		No Connect

Application Information

MODES OF OPERATION

The DS90CP22 provides three modes of operation. In the 1:2 splitter mode, the two outputs are copies of the same single input. This is useful for distribution / fan-out applications. In the repeater mode, the device operates as a 2 channel LVDS buffer. Repeating the signal restores the LVDS amplitude, allowing it to drive another media segment. This allows for isolation of segments or long distance applications. The switch mode provides a crosspoint function. This can be used in a system when primary and redundant paths are supported in fault tolerant applications.

INPUT FAIL-SAFE

The receiver inputs of the DS90CP22 do not have internal fail-safe biasing. For point-to-point and multidrop applications with a single source, fail-safe biasing may not be required. When the driver is off, the link is in-active. If fail-safe biasing is required, this can be accomplished with external high value resistors. The IN+ should be pull to V_{CC} with 10kΩ and the IN - should be pull to Gnd with 10kΩ. This provides a slight positive differential bias, and sets a known HIGH state on the link with a minimum amount of distortion.

UNUSED LVDS INPUTS

Unused LVDS Receiver inputs should be tied off to prevent the high-speed sensitive input stage from picking up noise signals. The open input to IN+ should be pull to V_{CC} with 10kΩ and the open input to IN- should be pull to Gnd with 10kΩ.

UNUSED CONTROL INPUTS

The SEL and EN control input pins have internal pull down devices. Unused pins may be tied off or left as no-connect (if a LOW state is desired).

EXPANDING THE NUMBER OF OUTPUT PORTS

To expand the number of output ports, more than one DS90CP22 can be used. Total propagation delay through the devices should be considered to determine the maximum expansion. For example, if 2 X 4 is desired, than three of the DS90CP22 are required. A minimum of two device propagation delays ($2 \times 1.3\text{ns} = 2.6\text{ns}$ (typ)) can be achieved. For a 2 X 8, a total of 7 devices must be used with propagation delay of $3 \times 1.3\text{ns} = 3.9\text{ns}$ (typ). The power consumption will increase proportional to the number of devices used.

PCB LAYOUT AND POWER SYSTEM BYPASS

Circuit board layout and stack-up for the DS90CP22 should be designed to provide noise-free power to the device. Good layout practice also will separate high frequency or high level inputs and outputs to minimize unwanted stray noise pickup, feedback and interference. Power system performance may be greatly improved by using thin dielectrics (4 to 10 mils) for power/ground sandwiches. This increases the intrinsic capacitance of the PCB power system which improves power supply filtering, especially at high frequencies, and makes the value and placement of external bypass capacitors less critical. External bypass capacitors should include both RF ceramic and tantalum electrolytic types. RF capacitors may use values in the range 0.01 μF to 0.1 μF. It is recommended practice to use two vias at each power pin of the DS90CP22 as well as all RF bypass capacitor terminals. Dual vias reduce the interconnect inductance by up to half, thereby reducing interconnect inductance and extending the effective frequency range of the bypass components.

The outer layers of the PCB may be flooded with additional ground plane. These planes will improve shielding and isolation as well as increase the intrinsic capacitance of the power supply plane system. Naturally, to be effective, these planes must be tied to the ground supply plane at frequent intervals with vias. Frequent via placement also improves signal integrity on signal transmission lines by providing short paths for image currents which reduces signal distortion.

There are more common practices which should be followed when designing PCBs for LVDS signaling. Please see Application Note: AN-1108 for additional information.

COMPATIBILITY WITH LVDS STANDARD

The DS90CP22 is compatible with LVDS and Bus LVDS Interface devices. It is enhanced over standard LVDS drivers in that it is able to driver lower impedance loads with standard LVDS levels. Standard LVDS drivers provide 330mV differential output with a 100Ω load. The DS90CP22 provides 365mV with a 75Ω load or 400mV with 100Ω loads. This extra drive capability is useful in certain multidrop applications.

In backplane multidrop configurations, with closely spaced loads, the effective differential impedance of the line is reduced. If the mainline has been designed for 100Ω differential impedance, the loading effects may reduce this to the 70Ω range depending upon spacing and capacitance load. Terminating the line with a 75Ω load is a better match than with 100Ω and reflections are reduced.

Block Diagram

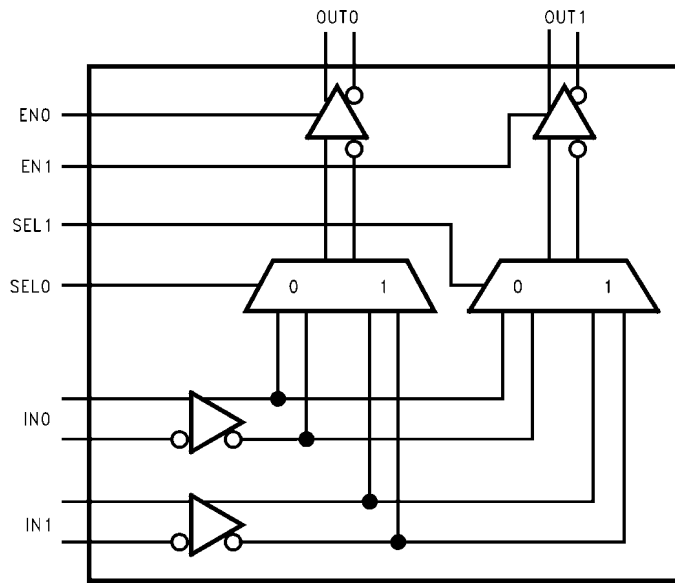

Function Table

SEL0	SEL1	OUT0	OUT1	Mode
0	0	IN0	IN0	1:2 splitter
0	1	IN0	IN1	repeater
1	0	IN1	IN0	switch
1	1	IN1	IN1	1:2 splitter

Note: 0 = low, 1 = high
 EN0 = EN1 = 1 for enable

Typical Performance Characteristics

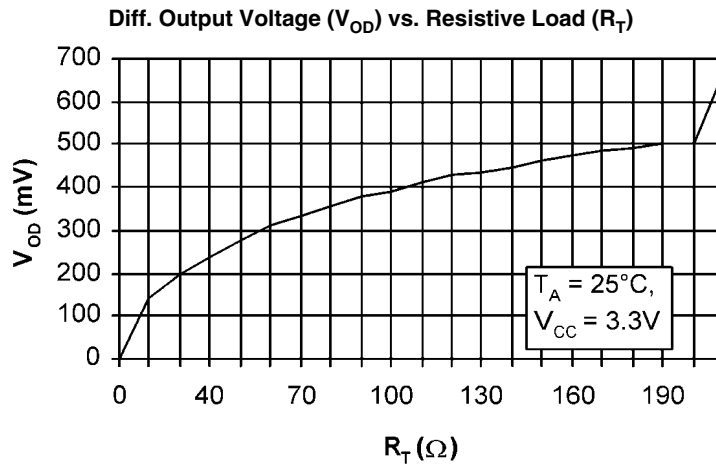

10105311

Peak-to-Peak Output Jitter at $V_{CM} = +0.4V$ vs. VID

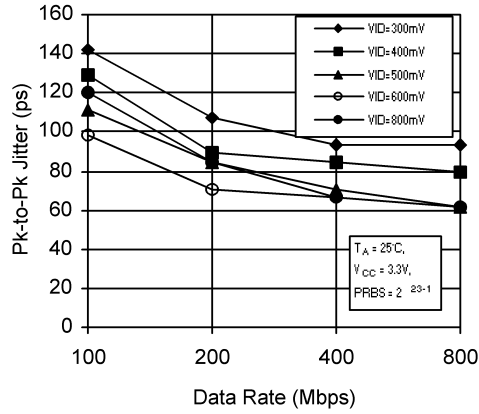

10105312

Peak-to-Peak Output Jitter at $V_{CM} = +1.2V$ vs. VID

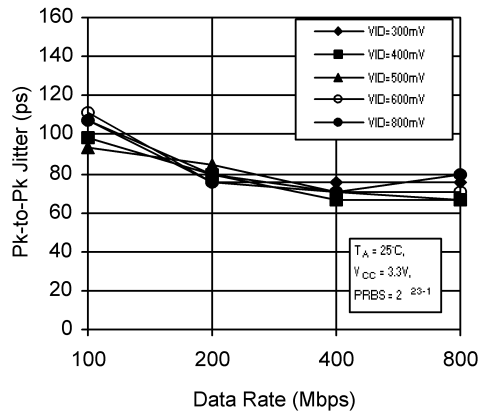

10105313

Peak-to-Peak Output Jitter at $V_{CM} = +1.6V$ vs. VID

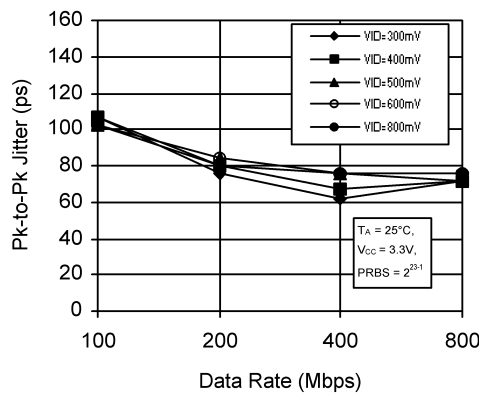

10105314

Physical Dimensions inches (millimeters) unless otherwise noted

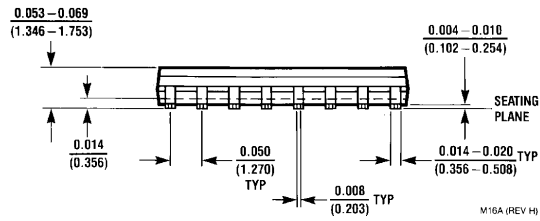
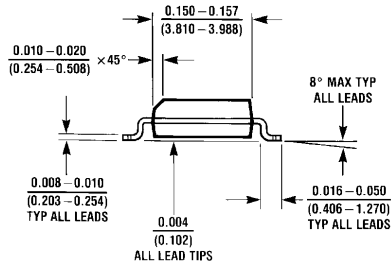
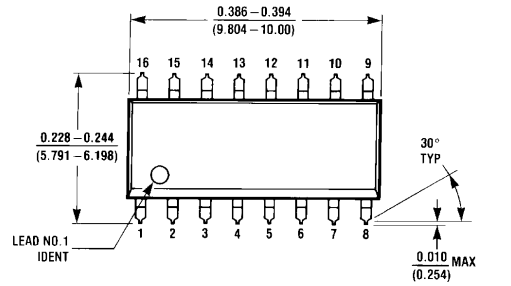

Order Number DS90CP22M-8
See NS Package Number M16A

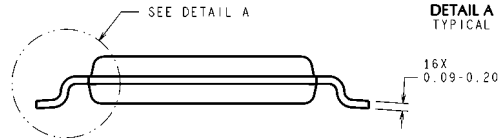
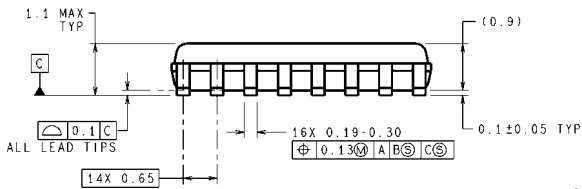
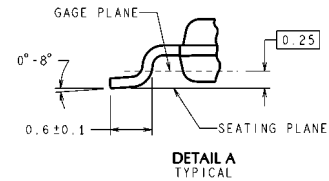
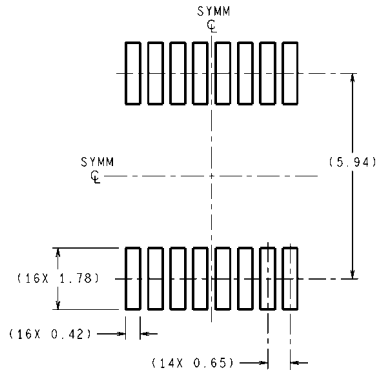
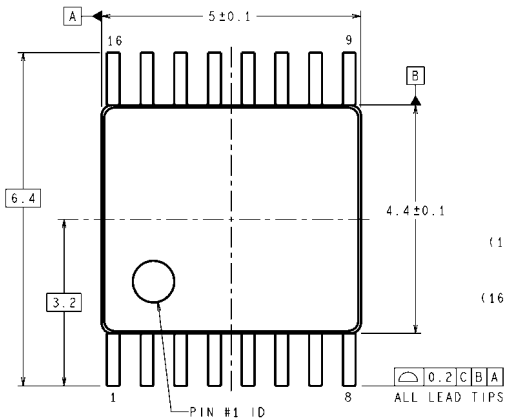

DIMENSIONS ARE IN MILLIMETERS
DIMENSIONS IN () FOR REFERENCE ONLY

16-Lead (4.4mm Wide) Molded Thin Shrink Small Outline Package, JEDEC
Order Number DS90CP22MT
Order Number DS90CP22MTX (Tape and Reel)
See NS Package Number MTC16

MTC16 (Rev D)

Notes

For more National Semiconductor product information and proven design tools, visit the following Web sites at:

Products		Design Support	
Amplifiers	www.national.com/amplifiers	WEBENCH	www.national.com/webench
Audio	www.national.com/audio	Analog University	www.national.com/AU
Clock Conditioners	www.national.com/timing	App Notes	www.national.com/appnotes
Data Converters	www.national.com/adc	Distributors	www.national.com/contacts
Displays	www.national.com/displays	Green Compliance	www.national.com/quality/green
Ethernet	www.national.com/ethernet	Packaging	www.national.com/packaging
Interface	www.national.com/interface	Quality and Reliability	www.national.com/quality
LVDS	www.national.com/lvds	Reference Designs	www.national.com/refdesigns
Power Management	www.national.com/power	Feedback	www.national.com/feedback
Switching Regulators	www.national.com/switchers		
LDOs	www.national.com/ldo		
LED Lighting	www.national.com/led		
PowerWise	www.national.com/powerwise		
Serial Digital Interface (SDI)	www.national.com/sdi		
Temperature Sensors	www.national.com/tempensors		
Wireless (PLL/VCO)	www.national.com/wireless		

THE CONTENTS OF THIS DOCUMENT ARE PROVIDED IN CONNECTION WITH NATIONAL SEMICONDUCTOR CORPORATION ("NATIONAL") PRODUCTS. NATIONAL MAKES NO REPRESENTATIONS OR WARRANTIES WITH RESPECT TO THE ACCURACY OR COMPLETENESS OF THE CONTENTS OF THIS PUBLICATION AND RESERVES THE RIGHT TO MAKE CHANGES TO SPECIFICATIONS AND PRODUCT DESCRIPTIONS AT ANY TIME WITHOUT NOTICE. NO LICENSE, WHETHER EXPRESS, IMPLIED, ARISING BY ESTOPPEL OR OTHERWISE, TO ANY INTELLECTUAL PROPERTY RIGHTS IS GRANTED BY THIS DOCUMENT.

TESTING AND OTHER QUALITY CONTROLS ARE USED TO THE EXTENT NATIONAL DEEMS NECESSARY TO SUPPORT NATIONAL'S PRODUCT WARRANTY. EXCEPT WHERE MANDATED BY GOVERNMENT REQUIREMENTS, TESTING OF ALL PARAMETERS OF EACH PRODUCT IS NOT NECESSARILY PERFORMED. NATIONAL ASSUMES NO LIABILITY FOR APPLICATIONS ASSISTANCE OR BUYER PRODUCT DESIGN. BUYERS ARE RESPONSIBLE FOR THEIR PRODUCTS AND APPLICATIONS USING NATIONAL COMPONENTS. PRIOR TO USING OR DISTRIBUTING ANY PRODUCTS THAT INCLUDE NATIONAL COMPONENTS, BUYERS SHOULD PROVIDE ADEQUATE DESIGN, TESTING AND OPERATING SAFEGUARDS.

EXCEPT AS PROVIDED IN NATIONAL'S TERMS AND CONDITIONS OF SALE FOR SUCH PRODUCTS, NATIONAL ASSUMES NO LIABILITY WHATSOEVER, AND NATIONAL DISCLAIMS ANY EXPRESS OR IMPLIED WARRANTY RELATING TO THE SALE AND/OR USE OF NATIONAL PRODUCTS INCLUDING LIABILITY OR WARRANTIES RELATING TO FITNESS FOR A PARTICULAR PURPOSE, MERCHANTABILITY, OR INFRINGEMENT OF ANY PATENT, COPYRIGHT OR OTHER INTELLECTUAL PROPERTY RIGHT.

LIFE SUPPORT POLICY

NATIONAL'S PRODUCTS ARE NOT AUTHORIZED FOR USE AS CRITICAL COMPONENTS IN LIFE SUPPORT DEVICES OR SYSTEMS WITHOUT THE EXPRESS PRIOR WRITTEN APPROVAL OF THE CHIEF EXECUTIVE OFFICER AND GENERAL COUNSEL OF NATIONAL SEMICONDUCTOR CORPORATION. As used herein:

Life support devices or systems are devices which (a) are intended for surgical implant into the body, or (b) support or sustain life and whose failure to perform when properly used in accordance with instructions for use provided in the labeling can be reasonably expected to result in a significant injury to the user. A critical component is any component in a life support device or system whose failure to perform can be reasonably expected to cause the failure of the life support device or system or to affect its safety or effectiveness.

National Semiconductor and the National Semiconductor logo are registered trademarks of National Semiconductor Corporation. All other brand or product names may be trademarks or registered trademarks of their respective holders.

Copyright© 2007 National Semiconductor Corporation

For the most current product information visit us at www.national.com



National Semiconductor Americas Customer Support Center
 Email: new.feedback@nsc.com
 Tel: 1-800-272-9959

National Semiconductor Europe Customer Support Center
 Fax: +49 (0) 180-530-85-86
 Email: europe.support@nsc.com
 Deutsch Tel: +49 (0) 69 9508 6208
 English Tel: +49 (0) 870 24 0 2171
 Français Tel: +33 (0) 1 41 91 8790

National Semiconductor Asia Pacific Customer Support Center
 Email: ap.support@nsc.com

National Semiconductor Japan Customer Support Center
 Fax: 81-3-5639-7507
 Email: jpn.feedback@nsc.com
 Tel: 81-3-5639-7560