

## ADG438F/ADG439F

### FEATURES

#### Fast Switching Times

$t_{ON}$  250 ns max

$t_{OFF}$  150 ns max

**Fault and Overvoltage Protection (-40 V, +55 V)**

**All Switches OFF with Power Supply OFF**

**Analog Output of ON Channel Clamped Within Power Supplies If an Overvoltage Occurs**

**Latch-Up Proof Construction**

**Break Before Make Construction**

**TTL and CMOS Compatible Inputs**

### APPLICATIONS

**Data Acquisition Systems**

**Industrial and Process Control Systems**

**Avionics Test Equipment**

**Signal Routing Between Systems**

**High Reliability Control Systems**

### FUNCTIONAL BLOCK DIAGRAMS

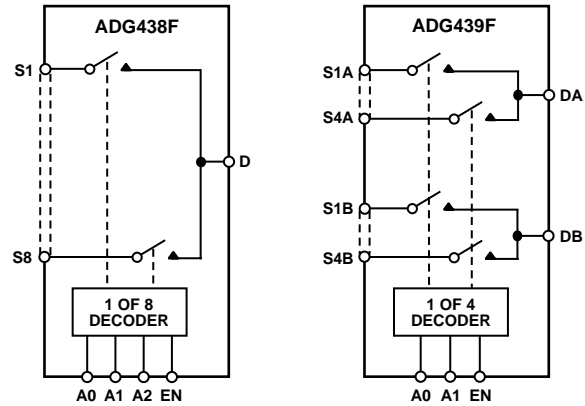

### GENERAL DESCRIPTION

The ADG438F/ADG439F are CMOS analog multiplexers, the ADG438F comprising 8 single channels and the ADG439F comprising four differential channels. These multiplexers provide fault protection. Using a series n-channel, p-channel, n-channel MOSFET structure, both device and signal source protection is provided in the event of an overvoltage or power loss. The multiplexer can withstand continuous overvoltage inputs from -40 V to +55 V. During fault conditions, the multiplexer input (or output) appears as an open circuit and only a few nanoamperes of leakage current will flow. This protects not only the multiplexer and the circuitry driven by the multiplexer, but also protects the sensors or signal sources which drive the multiplexer.

The ADG438F switches one of eight inputs to a common output as determined by the 3-bit binary address lines A0, A1 and A2. The ADG439F switches one of four differential inputs to a common differential output as determined by the 2-bit binary address lines A0 and A1. An EN input on each device is used to enable or disable the device. When disabled, all channels are switched OFF.

### PRODUCT HIGHLIGHTS

1. **Fault Protection.**  
The ADG438F/ADG439F can withstand continuous voltage inputs up to -40 V or +55 V. When a fault occurs due to the power supplies being turned off, all the channels are turned off and only a leakage current of a few nanoamperes flows.
2. ON channel turns OFF while fault exists.
3. Low  $R_{ON}$ .
4. Fast Switching Times.
5. **Break-Before-Make Switching.**  
Switches are guaranteed break-before-make so that input signals are protected against momentary shorting.
6. **Trench Isolation Eliminates Latch-up.**  
A dielectric trench separates the p- and n-channel MOSFETs thereby preventing latch-up.
7. **Improved OFF Isolation.**  
Trench isolation enhances the channel-to-channel isolation of the ADG438F/ADG439F.

### REV. D

Information furnished by Analog Devices is believed to be accurate and reliable. However, no responsibility is assumed by Analog Devices for its use, nor for any infringements of patents or other rights of third parties which may result from its use. No license is granted by implication or otherwise under any patent or patent rights of Analog Devices.

# ADG438F/ADG439F—SPECIFICATIONS<sup>1</sup>

Dual Supply ( $V_{DD} = +15\text{ V}$ ,  $V_{SS} = -15\text{ V}$ ,  $GND = 0\text{ V}$ , unless otherwise noted)

Parameter	B Version			Units	Test Conditions/Comments
	+25°C	-40°C to +85°C	-40°C to +105°C		
<b>ANALOG SWITCH</b>					
Analog Signal Range		$V_{SS} + 1.2$	$V_{SS} + 1.2$	V min	$-10\text{ V} \leq V_S \leq +10\text{ V}$ , $I_S = 1\text{ mA}$ ; $-5\text{ V} \leq V_S \leq +5\text{ V}$ , $I_S = 1\text{ mA}$ ; $V_S = 0\text{ V}$ , $I_S = 1\text{ mA}$ $V_S = \pm 10\text{ V}$ , $I_S = 1\text{ mA}$
$R_{ON}$		$V_{DD} - 0.8$	$V_{DD} - 0.8$	V max	
$\Delta R_{ON}$		400	400	$\Omega$ max	
$R_{ON}$ Drift	0.6	5	5	% max	
$R_{ON}$ Match	3	3	3	% max	
<b>LEAKAGE CURRENTS</b>					
Source OFF Leakage $I_S$ (OFF)	$\pm 0.01$			nA typ	$V_D = \pm 10\text{ V}$ , $V_S = \mp 10\text{ V}$ ; Test Circuit 2
	$\pm 0.5$	$\pm 2$	$\pm 5$	nA max	
Drain OFF Leakage $I_D$ (OFF)	$\pm 0.01$			nA typ	$V_D = \pm 10\text{ V}$ , $V_S = \mp 10\text{ V}$ ; Test Circuit 3
ADG438F	$\pm 0.5$	$\pm 5$	$\pm 30$	nA max	
ADG439F	$\pm 0.5$	$\pm 5$	$\pm 15$	nA max	
Channel ON Leakage $I_D$ , $I_S$ (ON)	$\pm 0.01$			nA typ	$V_S = V_D = \pm 10\text{ V}$ ; Test Circuit 4
ADG438F	$\pm 0.5$	$\pm 5$	$\pm 30$	nA max	
ADG439F	$\pm 0.5$	$\pm 5$	$\pm 15$	nA max	
<b>FAULT</b>					
Output Leakage Current (With Overvoltage)	$\pm 0.02$			nA typ	$V_S = -33\text{ V}$ , $+33\text{ V}$ or $+50\text{ V}$ , $V_D = 0\text{ V}$ , Test Circuit 3
	$\pm 0.1$	$\pm 2$	$\pm 10$	$\mu\text{A}$ max	
Input Leakage Current (With Overvoltage)	$\pm 0.005$			$\mu\text{A}$ typ	$V_S = \pm 25\text{ V}$ , $V_D = \mp 10\text{ V}$ , Test Circuit 5
	$\pm 0.1$	$\pm 1$	$\pm 2$	$\mu\text{A}$ max	
Input Leakage Current (With Power Supplies OFF)	$\pm 0.001$			$\mu\text{A}$ typ	$V_S = \pm 25\text{ V}$ , $V_D = V_{EN} = A_0, A_1, A_2 = 0\text{ V}$ Test Circuit 6
	$\pm 0.1$	$\pm 1$	$\pm 4$	$\mu\text{A}$ max	
<b>DIGITAL INPUTS</b>					
Input High Voltage, $V_{INH}$		2.4	2.4	V min	$V_{IN} = 0$ or $V_{DD}$
Input Low Voltage, $V_{INL}$		0.8	0.8	V max	
Input Current					
$I_{INL}$ or $I_{INH}$		$\pm 1$	$\pm 1$	$\mu\text{A}$ max	
$C_{IN}$ , Digital Input Capacitance	5			pF typ	
<b>DYNAMIC CHARACTERISTICS<sup>2</sup></b>					
$t_{TRANSITION}$	170			ns typ	$R_L = 1\text{ M}\Omega$ , $C_L = 35\text{ pF}$ ; $V_{S1} = \pm 10\text{ V}$ , $V_{S8} = \mp 10\text{ V}$ ; Test Circuit 7
	220	300	320	ns max	
$t_{OPEN}$	10	10	10	ns min	
$t_{ON}$ (EN)	200			ns typ	$R_L = 1\text{ k}\Omega$ , $C_L = 35\text{ pF}$ ; $V_S = +5\text{ V}$ ; Test Circuit 8
	250	300	300	ns max	
$t_{OFF}$ (EN)	110			ns typ	$R_L = 1\text{ k}\Omega$ , $C_L = 35\text{ pF}$ ; $V_S = +5\text{ V}$ ; Test Circuit 9
	150	180	180	ns max	
$t_{SETT}$ , Settling Time					$R_L = 1\text{ k}\Omega$ , $C_L = 35\text{ pF}$ ; $V_S = +5\text{ V}$
0.1%		0.5	0.5	$\mu\text{s}$ typ	
0.01%		1.7	1.7	$\mu\text{s}$ typ	
Charge Injection	4			pC typ	$V_S = 0\text{ V}$ , $R_S = 0\text{ }\Omega$ , $C_L = 1\text{ nF}$ ; Test Circuit 10
OFF Isolation	80			dB typ	
Channel-to-Channel Crosstalk	85			dB typ	$R_L = 1\text{ k}\Omega$ , $C_L = 15\text{ pF}$ , $f = 100\text{ kHz}$ ; $V_S = 7\text{ V rms}$ ; Test Circuit 11
$C_S$ (OFF)	5			pF typ	$R_L = 1\text{ k}\Omega$ , $C_L = 15\text{ pF}$ , $f = 100\text{ kHz}$ ; $V_S = 7\text{ V rms}$ ; Test Circuit 12
$C_D$ (OFF)					
ADG438F	50			pF typ	
ADG439F	25			pF typ	
<b>POWER REQUIREMENTS</b>					
$I_{DD}$	0.05			mA typ	$V_{IN} = 0\text{ V}$ or $5\text{ V}$
	0.15	0.25	0.25	mA max	
$I_{SS}$	0.01			mA typ	
	0.02	0.04	0.04	mA max	

## NOTES

<sup>1</sup>Temperature range is as follows: B Version:  $-40^\circ\text{C}$  to  $+105^\circ\text{C}$ .

<sup>2</sup>Guaranteed by design, not subject to production test.

Specifications subject to change without notice.

# ADG438F/ADG439F

## ABSOLUTE MAXIMUM RATINGS\*

(T<sub>A</sub> = +25°C unless otherwise noted)

V <sub>DD</sub> to V <sub>SS</sub> .....	+44 V
V <sub>DD</sub> to GND .....	-0.3 V to +25 V
V <sub>SS</sub> to GND .....	+0.3 V to -25 V
V <sub>EN</sub> , V <sub>A</sub> Digital Input .....	-0.3 V to V <sub>DD</sub> + 2 V or 20 mA, Whichever Occurs First
V <sub>S</sub> , Analog Input Overvoltage with Power ON .....	V <sub>SS</sub> - 25 V to V <sub>DD</sub> + 40 V
V <sub>S</sub> , Analog Input Overvoltage with Power OFF .....	-40 V to +55 V
Continuous Current, S or D .....	20 mA
Peak Current, S or D .....	40 mA
(Pulsed at 1 ms, 10% Duty Cycle max)	
Operating Temperature Range	
Industrial (B Version) .....	-40°C to +105°C
Storage Temperature Range .....	-65°C to +150°C
Junction Temperature .....	+150°C
Plastic Package	
θ <sub>JA</sub> , Thermal Impedance .....	117°C/W
Lead Temperature, Soldering (10 sec) .....	+260°C
SOIC Package	
θ <sub>JA</sub> , Thermal Impedance	
Narrow Body .....	125°C/W
Wide Body .....	90°C/W
Lead Temperature, Soldering	
Vapor Phase (60 sec) .....	+215°C
Infrared (15 sec) .....	+220°C

\*Stresses above those listed under Absolute Maximum Ratings may cause permanent damage to the device. This is a stress rating only; functional operation of the device at these or any other conditions above those listed in the operational sections of this specification is not implied. Exposure to absolute maximum rating conditions for extended periods may affect device reliability. Only one absolute maximum rating may be applied at any one time.

## ORDERING GUIDE

Model	Temperature Range	Package Option*
ADG438FBN	-40°C to +105°C	N-16
ADG438FBR	-40°C to +105°C	R-16N
ADG439FBN	-40°C to +105°C	N-16
ADG439FBR	-40°C to +105°C	R-16N
ADG439FBRW	-40°C to +105°C	R-16W

\*N = Plastic DIP; R-16N = 0.15" Small Outline IC (SOIC); R-16W = 0.3" Small Outline IC (SOIC).

## CAUTION

ESD (electrostatic discharge) sensitive device. Electrostatic charges as high as 4000 V readily accumulate on the human body and test equipment and can discharge without detection. Although the ADG438F/ADG439F features proprietary ESD protection circuitry, permanent damage may occur on devices subjected to high energy electrostatic discharges. Therefore, proper ESD precautions are recommended to avoid performance degradation or loss of functionality.

**Table I. ADG438F Truth Table**

A2	A1	A0	EN	ON SWITCH
X	X	X	0	NONE
0	0	0	1	1
0	0	1	1	2
0	1	0	1	3
0	1	1	1	4
1	0	0	1	5
1	0	1	1	6
1	1	0	1	7
1	1	1	1	8

X = Don't Care

**Table II. ADG439F Truth Table**

A1	A0	EN	ON SWITCH PAIR
X	X	0	NONE
0	0	1	1
0	1	1	2
1	0	1	3
1	1	1	4

X = Don't Care

## ADG438F/ADG439F PIN CONFIGURATIONS

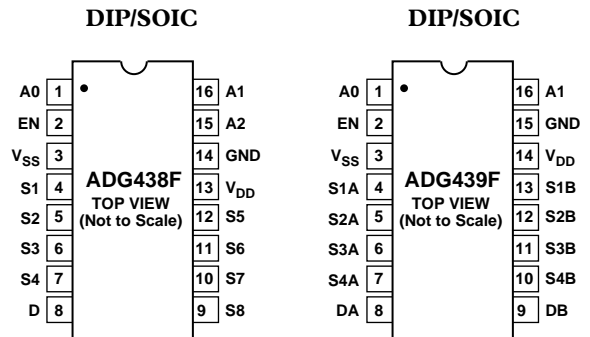

# ADG438F/ADG439F

## TERMINOLOGY

$V_{DD}$	Most positive power supply potential.
$V_{SS}$	Most negative power supply potential.
GND	Ground (0 V) reference.
$R_{ON}$	Ohmic resistance between D and S.
$\Delta R_{ON}$	$R_{ON}$ variation due to a change in the analog input voltage with a constant load current.
$R_{ON}$ Drift	Change in $R_{ON}$ when temperature changes by one degree Celsius.
$R_{ON}$ Match	Difference between the $R_{ON}$ of any two channels.
$I_S$ (OFF)	Source leakage current when the switch is off.
$I_D$ (OFF)	Drain leakage current when the switch is off.
$I_D, I_S$ (ON)	Channel leakage current when the switch is on.
$V_D$ ( $V_S$ )	Analog voltage on terminals D, S.
$C_S$ (OFF)	Channel input capacitance for "OFF" condition.
$C_D$ (OFF)	Channel output capacitance for "OFF" condition.
$C_D, C_S$ (ON)	"ON" switch capacitance.
$C_{IN}$	Digital input capacitance.
$t_{ON}$ (EN)	Delay time between the 50% and 90% points of the digital input and switch "ON" condition.
$t_{OFF}$ (EN)	Delay time between the 50% and 90% points of the digital input and switch "OFF" condition.
$t_{TRANSITION}$	Delay time between the 50% and 90% points of the digital inputs and the switch "ON" condition when switching from one address state to another.
$t_{OPEN}$	"OFF" time measured between 80% points of both switches when switching from one address state to another.
$V_{INL}$	Maximum input voltage for Logic "0".
$V_{INH}$	Minimum input voltage for Logic "1".
$I_{INL}$ ( $I_{INH}$ )	Input current of the digital input.
Off Isolation	A measure of unwanted signal coupling through an "OFF" channel.
Charge Injection	A measure of the glitch impulse transferred from the digital input to the analog output during switching.
$I_{DD}$	Positive supply current.
$I_{SS}$	Negative supply current.

## Typical Performance Graphs

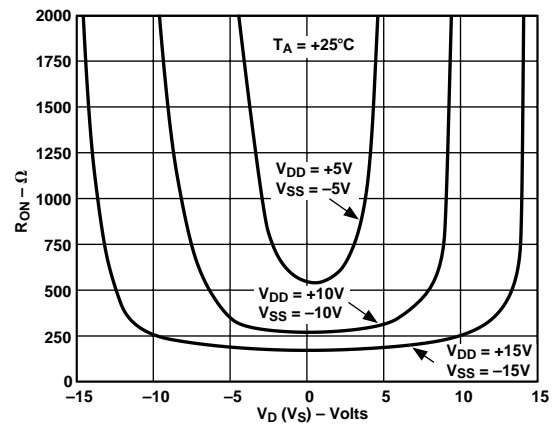

Figure 1. On Resistance as a Function of  $V_D$  ( $V_S$ )

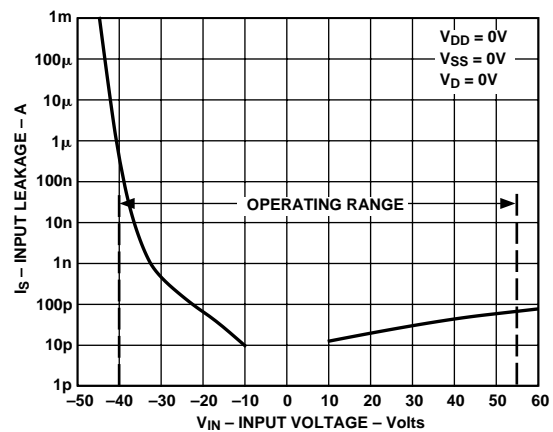

Figure 2. Input Leakage Current as a Function of  $V_S$  (Power Supplies OFF) During Overvoltage Conditions

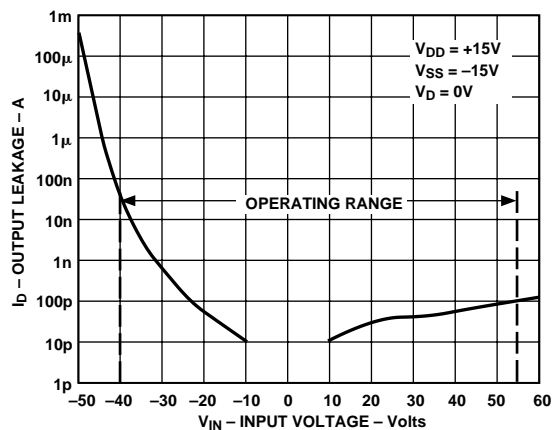

Figure 3. Output Leakage Current as a Function of  $V_S$  (Power Supplies ON) During Overvoltage Conditions

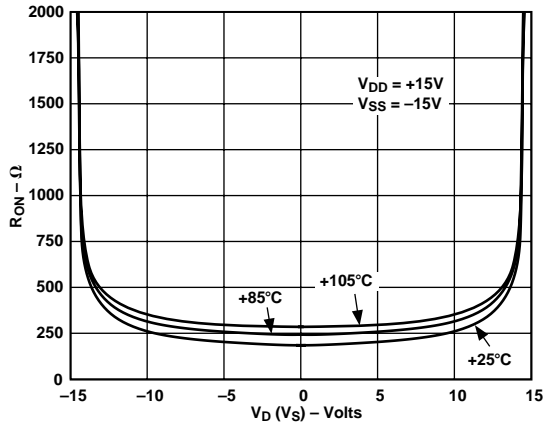

Figure 4. On Resistance as a Function of  $V_D$  ( $V_S$ ) for Different Temperatures

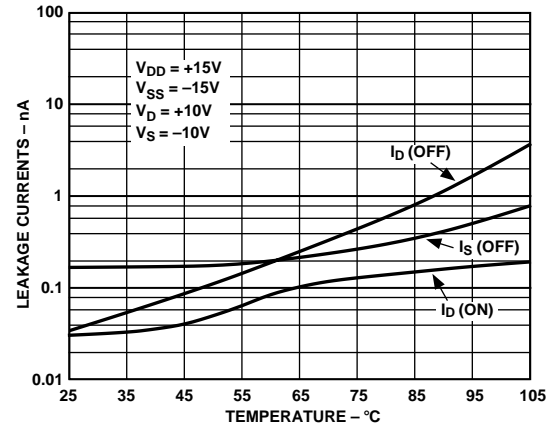

Figure 7. Leakage Currents as a Function of Temperature

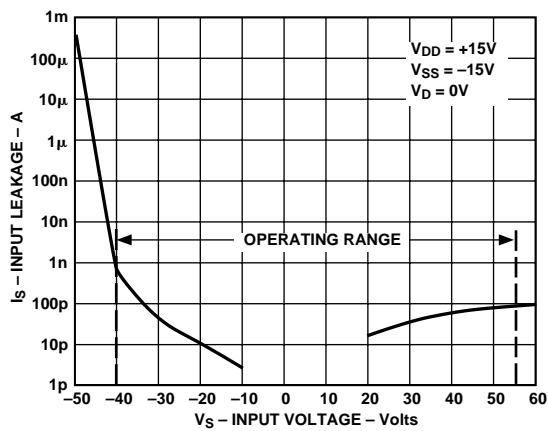

Figure 5. Input Leakage Current as a Function of  $V_S$  (Power Supplies ON) During Overvoltage Conditions

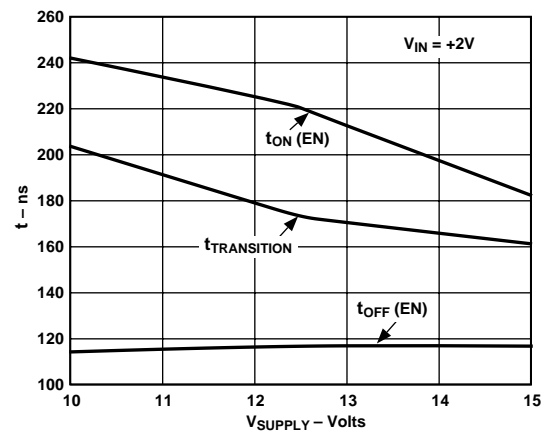

Figure 8. Switching Time vs. Power Supply

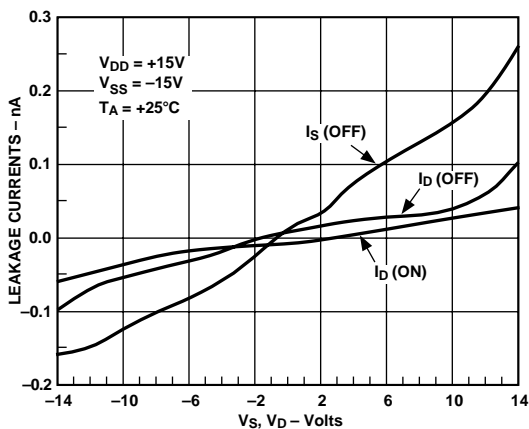

Figure 6. Leakage Currents as a Function of  $V_D$  ( $V_S$ )

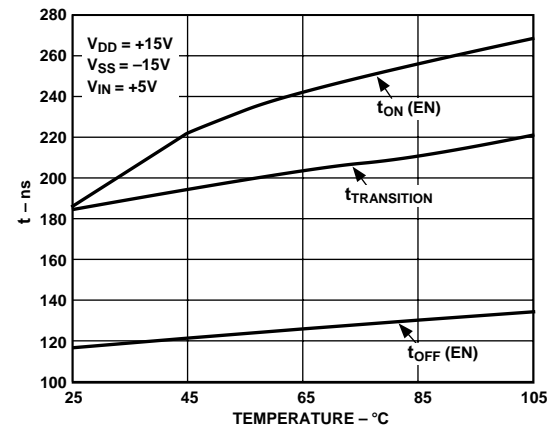

Figure 9. Switching Time vs. Temperature

# ADG438F/ADG439F

## THEORY OF OPERATION

The ADG438F/ADG439F multiplexers are capable of withstanding overvoltages from  $-40\text{ V}$  to  $+55\text{ V}$ , irrespective of whether the power supplies are present or not. Each channel of the multiplexer consists of an n-channel MOSFET, a p-channel MOSFET and an n-channel MOSFET, connected in series. When the analog input exceeds the power supplies, one of the MOSFETs will switch off, limiting the current to sub-microamp levels, thereby preventing the overvoltage from damaging any circuitry following the multiplexer. Figure 12 illustrates the channel architecture that enables these multiplexers to withstand continuous overvoltages.

When an analog input of  $V_{SS} + 1.2\text{ V}$  to  $V_{DD} - 0.8\text{ V}$  is applied to the ADG438F/ADG439F, the multiplexer behaves as a standard multiplexer, with specifications similar to a standard multiplexer, for example, the on-resistance is  $180\ \Omega$  typically. However, when an overvoltage is applied to the device, one of the three MOSFETs will turn off.

Figures 10 to 13 show the conditions of the three MOSFETs for the various overvoltage situations. When the analog input applied to an ON channel approaches the positive power supply line, the n-channel MOSFET turns OFF since the voltage on the analog input exceeds the difference between  $V_{DD}$  and the

n-channel threshold voltage ( $V_{TN}$ ). When a voltage more negative than  $V_{SS}$  is applied to the multiplexer, the p-channel MOSFET will turn off since the analog input is more negative than the difference between  $V_{SS}$  and the p-channel threshold voltage ( $V_{TP}$ ).

When the power supplies are present but the channel is off, again either the p-channel MOSFET or one of the n-channel MOSFETs will remain off when an overvoltage occurs.

Finally, when the power supplies are off, the gate of each MOSFET will be at ground. A negative overvoltage switches on the first n-channel MOSFET but the bias produced by the overvoltage causes the p-channel MOSFET to remain turned off. With a positive overvoltage, the first MOSFET in the series will remain off since the gate to source voltage applied to this MOSFET is negative.

During fault conditions, the leakage current into and out of the ADG438F/ADG439F is limited to a few microamps. This protects the multiplexer and succeeding circuitry from over stresses as well as protecting the signal sources which drive the multiplexer. Also, the other channels of the multiplexer will be undisturbed by the overvoltage and will continue to operate normally.

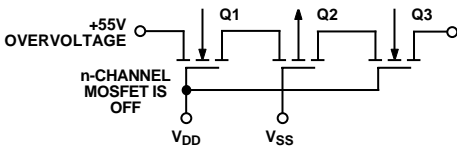

Figure 10. +55 V Overvoltage Input to the ON Channel

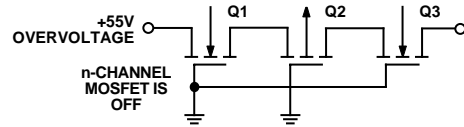

Figure 12. +55 V Overvoltage with Power OFF

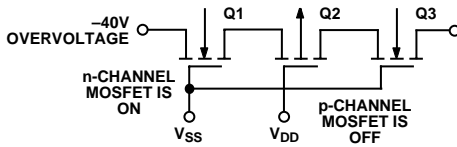

Figure 11. -40 V Overvoltage on an OFF Channel with Multiplexer Power ON

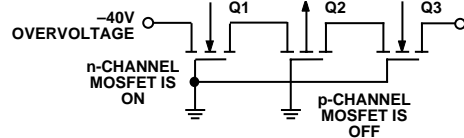
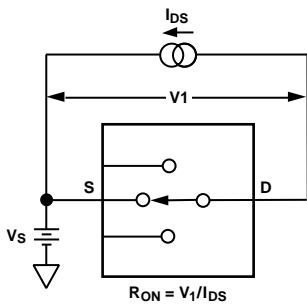
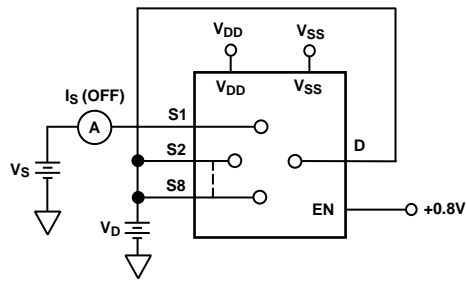

Figure 13. -40 V Overvoltage with Power OFF

## Test Circuits



Test Circuit 1. On Resistance



Test Circuit 2.  $I_S$  (OFF)

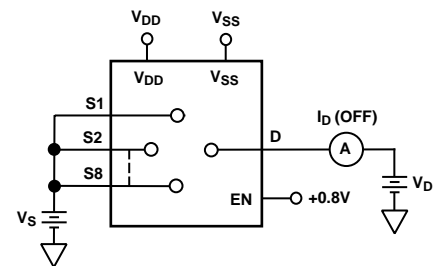

Test Circuit 3.  $I_D$  (OFF)

# ADG438F/ADG439F

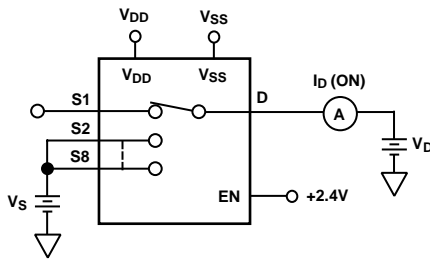

Test Circuit 4.  $I_D$  (ON)

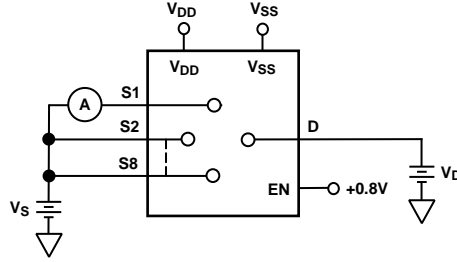

Test Circuit 5. Input Leakage Current (with Overvoltage)

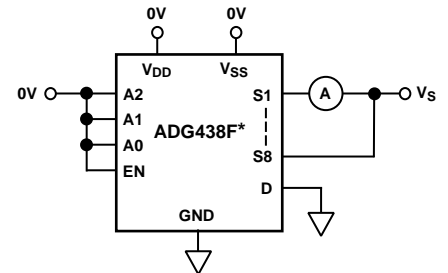

Test Circuit 6. Input Leakage Current (with Power Supplies OFF)

\* SIMILAR CONNECTION FOR ADG439F

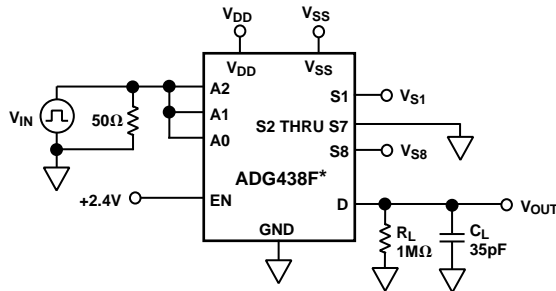

\* SIMILAR CONNECTION FOR ADG439F

Test Circuit 7. Switching Time of Multiplexer,  $t_{TRANSITION}$

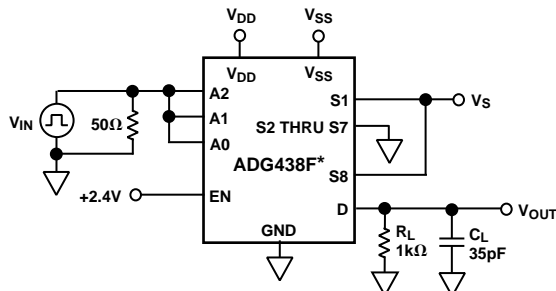
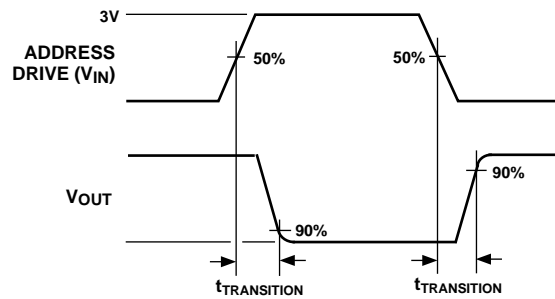

\* SIMILAR CONNECTION FOR ADG439F

Test Circuit 8. Break-Before-Make Delay,  $t_{OPEN}$

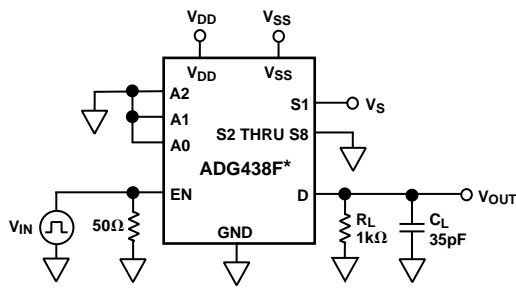
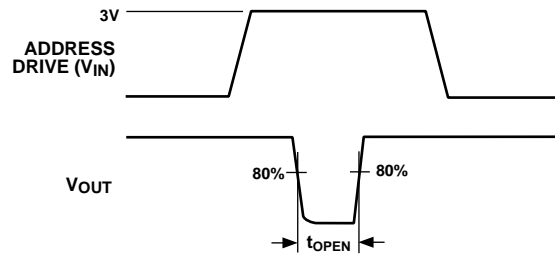

\* SIMILAR CONNECTION FOR ADG439F

Test Circuit 9. Enable Delay,  $t_{ON}$  (EN),  $t_{OFF}$  (EN)

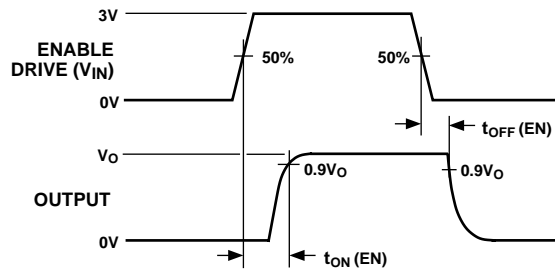

# ADG438F/ADG439F

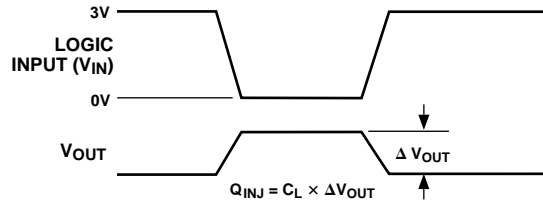
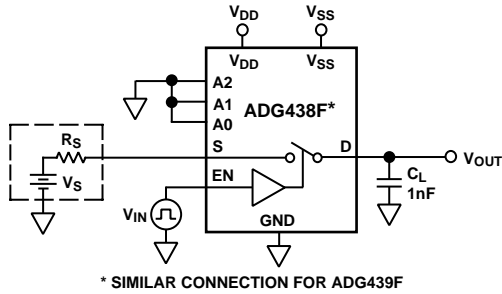

Test Circuit 10. Charge Injection

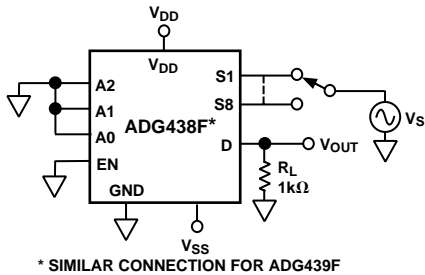

Test Circuit 11. OFF Isolation

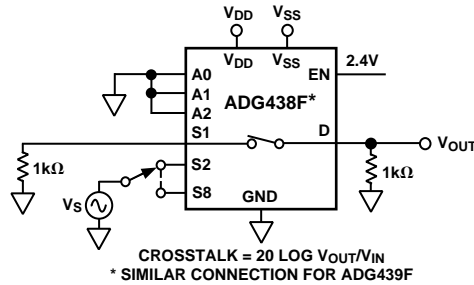

Test Circuit 12. Channel-to-Channel Crosstalk

## OUTLINE DIMENSIONS

Dimensions shown in inches and (mm).

### 16-Lead Plastic (N-16)

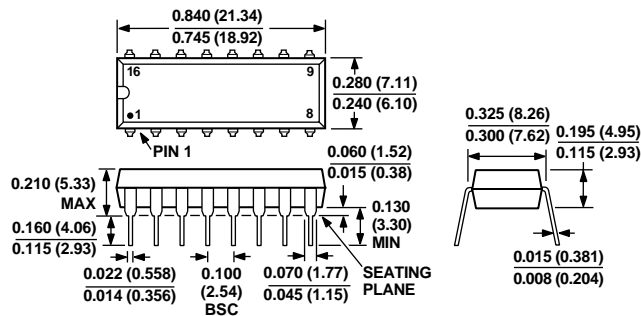

### 16-Lead SOIC (R-16W) (Wide Body)

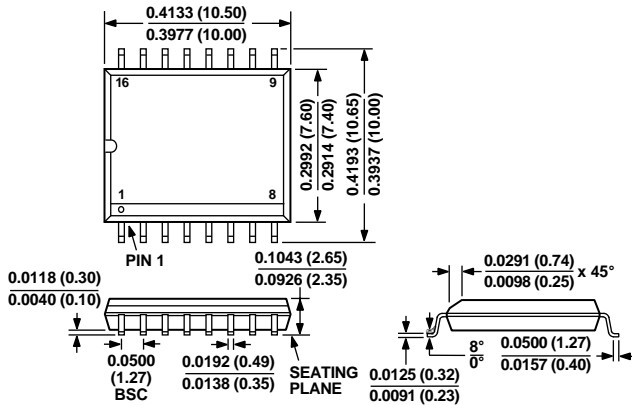

### 16-Lead SOIC (R-16N) (Narrow Body)

