



ISP1563

Hi-Speed Universal Serial Bus PCI Host Controller

Rev. 01 — 14 July 2005

Product data sheet



1. General description

The ISP1563 is a Peripheral Component Interconnect (PCI)-based, single-chip Universal Serial Bus (USB) Host Controller. It integrates two Original USB Open Host Controller Interface (OHCI) cores, one Hi-Speed USB Enhanced Host Controller Interface (EHCI) core, and four transceivers that are compliant with Hi-Speed USB and Original USB. The functional parts of the ISP1563 are fully compliant with *Universal Serial Bus Specification Rev. 2.0*, *Open Host Controller Interface Specification for USB Rev. 1.0a*, *Enhanced Host Controller Interface Specification for Universal Serial Bus Rev. 1.0*, *PCI Local Bus Specification Rev. 2.2*, and *PCI Bus Power Management Interface Specification Rev. 1.1*.

The integrated high performance USB transceivers allow the ISP1563 to handle all Hi-Speed USB transfer speed modes: high-speed (480 Mbit/s), full-speed (12 Mbit/s) and low-speed (1.5 Mbit/s). The ISP1563 provides four downstream ports, allowing simultaneous connection of USB devices at different speeds.

The ISP1563 provides downstream port status indicators, green and amber LEDs, to allow user-rich messages of the Root Hub downstream ports status, without requiring detailed port information in the internal registers.

The ISP1563 is fully compatible with various operating system drivers, such as Microsoft Windows standard OHCI and EHCI drivers that are present in Windows XP, Windows 2000 and Red Hat Linux.

The ISP1563 directly interfaces to any 32-bit, 33 MHz PCI bus. Its PCI pins can source 3.3 V. The PCI interface fully complies with *PCI Local Bus Specification Rev. 2.2*.

The ISP1563 is ideally suited for use in Hi-Speed USB host-enabled motherboards, Hi-Speed USB host PCI add-on card applications, mobile applications, and embedded solutions.

To facilitate motherboard development, the ISP1563 can use the available 48 MHz clock signal to reduce the total cost of a solution. To reduce Electro-Magnetic Interference (EMI), however, it is recommended that the 12 MHz crystal is used in PCI add-on card designs.

PHILIPS

2. Features

- Complies with *Universal Serial Bus Specification Rev. 2.0*
- Supports data transfer at high-speed (480 Mbit/s), full-speed (12 Mbit/s) and low-speed (1.5 Mbit/s)
- Two Original USB OHCI cores comply with *Open Host Controller Interface Specification for USB Rev. 1.0a*
- One Hi-Speed USB EHCI core complies with *Enhanced Host Controller Interface Specification for Universal Serial Bus Rev. 1.0*
- Supports PCI 32-bit, 33 MHz interface compliant with *PCI Local Bus Specification Rev. 2.2*, with support for D3_{cold} standby and wake-up modes; all I/O pins are 3.3 V standard
- Compliant with *PCI Bus Power Management Interface Specification Rev. 1.1* for all hosts (EHCI and OHCI), and supports all power states: D0, D1, D2, D3_{hot} and D3_{cold}
- Four downstream ports with support for downstream port indicator LEDs: amber and green
- Configurable two or four port root hubs
- CLKRUN support for mobile applications, such as internal notebook design
- Configurable subsystem ID and subsystem Vendor ID through external EEPROM
- Digital and analog power separation for better EMI and Electro-Static Discharge (ESD) protection
- Supports hot Plug and Play and remote wake-up of peripherals
- Supports individual power switching and individual overcurrent protection for downstream ports
- Supports partial dynamic port-routing capability for downstream ports that allows sharing of the same physical downstream ports between the Original USB Host Controller and the Hi-Speed USB Host Controller
- Supports legacy PS/2 keyboard and mouse
- Uses 12 MHz crystal oscillator to reduce system cost and EMI emissions
- Supports dual power supply: PCI V_{aux(3V3)} and V_{CC}
- Operates at +3.3 V power supply input
- Low power consumption
- Full industrial operating temperature range from -40 °C to +85 °C
- Full-scan design with high fault coverage (93 % to 95 %) ensures high quality
- Available in LQFP128 package.

3. Applications

- Digital consumer appliances
- Notebook
- PCI add-on card
- PC motherboard
- Set-Top Box (STB)
- Web appliances.



4. Ordering information

Table 1: Ordering information

Type number	Package		
	Name	Description	Version
ISP1563BM	LQFP128	plastic low profile quad flat package; 128 leads; body 14 × 14 × 1.4 mm	SOT420-1

6. Pinning information

6.1 Pinning

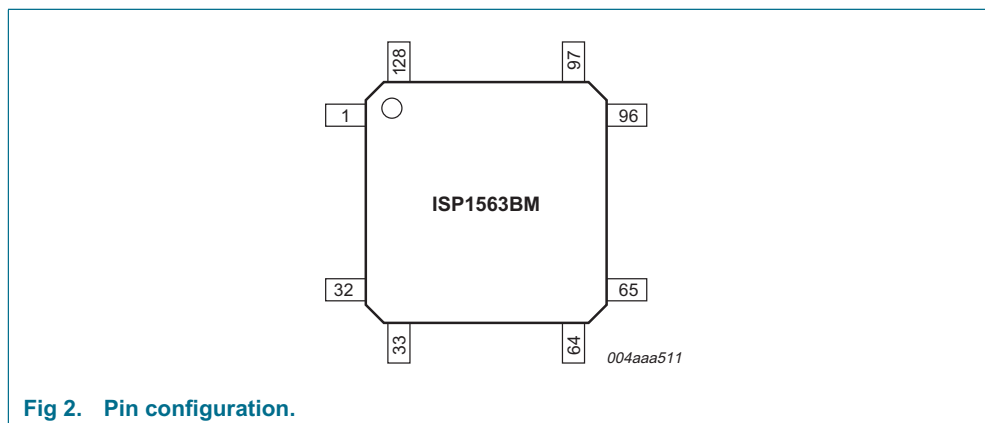

6.2 Pin description

Table 2: Pin description

Symbol ^[1]	Pin	Type	Description
PME#	1	O	PCI Power Management Event; used by a device to request a change in the device or system power state PCI pad; 3.3 V signaling; open-drain
GNDD	2	-	digital ground
IRQ1	3	O	system keyboard interrupt; when not in use, pull-down to ground through a 10 kΩ resistor 3.3 V output pad; 3 ns slew rate control; CMOS; open-drain
IRQ12	4	O	system mouse interrupt; when not in use, pull-down to ground through a 10 kΩ resistor 3.3 V output pad; 3 ns slew rate control; CMOS; open-drain
SEL2PORTS	5	I	select two or four ports: <ul style="list-style-type: none"> • LOW: four ports selected • HIGH: two ports selected. 3.3 V input pad; push-pull; CMOS
V _{CC(I/O)_AUX}	6	-	3.3 V auxiliary supply voltage; used to power pads; add a 100 nF decoupling capacitor
A20OUT	7	O	legacy gate 20 output; when not in use, pull-down to ground through a 10 kΩ resistor 3.3 V output pad; 3 ns slew rate control; CMOS; open-drain
KBIRQ1	8	I	legacy keyboard interrupt input; when not in use, pull-down to ground through a 10 kΩ resistor ^[2] 3.3 V input pad; push-pull; CMOS
MUIRQ12	9	I	legacy mouse interrupt input; when not in use, pull-down to ground through a 10 kΩ resistor ^[2] 3.3 V input pad; push-pull; CMOS
GNDA	10	-	analog ground

Table 2: Pin description...continued

Symbol ^[1]	Pin	Type	Description
AUX1V8	11	-	1.8 V auxiliary output voltage; only for voltage conditioning; cannot be used to supply power to external components; connected to 100 nF and 20 μ F capacitors
$V_{I(VAUX3V3)}$	12	-	3.3 V auxiliary input supply voltage; add a 100 nF decoupling capacitor
SMI#	13	O	System Management Interrupt; when not in use, pull-up to 3.3 V through a 10 k Ω resistor 3.3 V output pad; 3 ns slew rate control; CMOS; open-drain
INTA#	14	O	PCI interrupt PCI pad; 3.3 V signaling; open-drain
RST#	15	I	PCI reset; used to bring PCI-specific registers, sequencers and signals to a consistent state 3.3 V input pad; push-pull; CMOS
GNDD	16	-	digital ground
PCICLK	17	I	PCI system clock (33 MHz) PCI pad; 3.3 V signaling
GNT#	18	I/O	PCI grant; indicates to the agent that access to the bus is granted PCI pad; 3.3 V signaling
REQ#	19	I/O	PCI request; indicates to the arbitrator that the agent wants to use the bus PCI pad; 3.3 V signaling
AD[31]	20	I/O	bit 31 of multiplexed PCI address and data PCI pad; 3.3 V signaling
$V_{CC(I/O)}$	21	-	3.3 V supply voltage; used to power pads; add a 100 nF decoupling capacitor
AD[30]	22	I/O	bit 30 of multiplexed PCI address and data PCI pad; 3.3 V signaling
AD[29]	23	I/O	bit 29 of multiplexed PCI address and data PCI pad; 3.3 V signaling
AD[28]	24	I/O	bit 28 of multiplexed PCI address and data PCI pad; 3.3 V signaling
AD[27]	25	I/O	bit 27 of multiplexed PCI address and data PCI pad; 3.3 V signaling
$V_{I(VREG3V3)}$	26	-	3.3 V regulator input supply voltage; add a 100 nF decoupling capacitor
GNDA	27	-	analog ground
REG1V8	28	-	1.8 V regulator output voltage; only for voltage conditioning; cannot be used to supply power to external components; connected to 100 nF and 20 μ F capacitors
GNDD	29	-	digital ground
AD[26]	30	I/O	bit 26 of multiplexed PCI address and data PCI pad; 3.3 V signaling
AD[25]	31	I/O	bit 25 of multiplexed PCI address and data PCI pad; 3.3 V signaling

Table 2: Pin description...continued

Symbol ^[1]	Pin	Type	Description
AD[24]	32	I/O	bit 24 of multiplexed PCI address and data PCI pad; 3.3 V signaling
C/BE#[3]	33	I/O	byte 3 of multiplexed PCI bus command and byte enable PCI pad; 3.3 V signaling
IDSEL	34	I	PCI initialization device select; used as a chip select during configuration read and write transactions PCI pad; 3.3 V signaling
V _{CC(I/O)}	35	-	3.3 V supply voltage; used to power pads; add a 100 nF decoupling capacitor
AD[23]	36	I/O	bit 23 of multiplexed PCI address and data PCI pad; 3.3 V signaling
AD[22]	37	I/O	bit 22 of multiplexed PCI address and data PCI pad; 3.3 V signaling
AD[21]	38	I/O	bit 21 of multiplexed PCI address and data PCI pad; 3.3 V signaling
AD[20]	39	I/O	bit 20 of multiplexed PCI address and data PCI pad; 3.3 V signaling
AD[19]	40	I/O	bit 19 of multiplexed PCI address and data PCI pad; 3.3 V signaling
AD[18]	41	I/O	bit 18 of multiplexed PCI address and data PCI pad; 3.3 V signaling
GNDD	42	-	digital ground
AD[17]	43	I/O	bit 17 of multiplexed PCI address and data PCI pad; 3.3 V signaling
AD[16]	44	I/O	bit 16 of multiplexed PCI address and data PCI pad; 3.3 V signaling
C/BE#[2]	45	I/O	byte 2 of multiplexed PCI bus command and byte enable PCI pad; 3.3 V signaling
FRAME#	46	I/O	PCI cycle frame; driven by the master to indicate the beginning and duration of an access PCI pad; 3.3 V signaling
IRDY#	47	I/O	PCI initiator ready; indicates the ability of the initiating agent to complete the current data phase of a transaction PCI pad; 3.3 V signaling
TRDY#	48	I/O	PCI target ready; indicates the ability of the target agent to complete the current data phase of a transaction PCI pad; 3.3 V signaling
DEVSEL#	49	I/O	PCI device select; indicates if any device is selected on the bus PCI pad; 3.3 V signaling
V _{CC(I/O)}	50	-	3.3 V supply voltage; used to power pads; add a 100 nF decoupling capacitor
STOP#	51	I/O	PCI stop; indicates that the current target is requesting the master to stop the current transaction PCI pad; 3.3 V signaling

Table 2: Pin description...continued

Symbol [1]	Pin	Type	Description
CLKRUN#	52	I/O	PCI CLKRUN signal; pull-down to ground through a 10 kΩ resistor PCI pad; 3.3 V signaling; open-drain
REG1V8	53	-	1.8 V regulator output voltage; only for voltage conditioning; cannot be used to supply power to external components; add a 100 nF decoupling capacitor
PERR#	54	I/O	PCI parity error; used to report data parity errors during all PCI transactions, except a Special Cycle PCI pad; 3.3 V signaling
SERR#	55	I/O	PCI system error; used to report address parity errors and data parity errors on the Special Cycle command, or any other system error in which the result will be catastrophic PCI pad; 3.3 V signaling; open-drain
GND A	56	-	analog ground
PAR	57	I/O	PCI parity PCI pad; 3.3 V signaling
C/BE#[1]	58	I/O	byte 1 of multiplexed PCI bus command and byte enable PCI pad; 3.3 V signaling
GNDD	59	-	digital ground
AD[15]	60	I/O	bit 15 of multiplexed PCI address and data PCI pad; 3.3 V signaling
AD[14]	61	I/O	bit 14 of multiplexed PCI address and data PCI pad; 3.3 V signaling
AD[13]	62	I/O	bit 13 of multiplexed PCI address and data PCI pad; 3.3 V signaling
AMB4	63	I/O	amber LED indicator output for the USB downstream port 4; this pin acts as an input only during the power-up sequence and thereafter, acts as an output: <ul style="list-style-type: none"> • HIGH: FFh in the PMC register; supports D3_{cold} • LOW: EFh in the PMC register; does not support D3_{cold}. 3.3 V bidirectional pad; three-state output; 3 ns slew-rate control; input; CMOS; open-drain
GRN4	64	O	green LED indicator output for the USB downstream port 4; the LED is off by default; the LED can be programmed to enable it to blink 3.3 V output pad; 3 ns slew rate control; CMOS; open-drain
AD[12]	65	I/O	bit 12 of multiplexed PCI address and data PCI pad; 3.3 V signaling
AD[11]	66	I/O	bit 11 of multiplexed PCI address and data PCI pad; 3.3 V signaling
V _{CC(I/O)}	67	-	3.3 V supply voltage; used to power pads; add a 100 nF decoupling capacitor
AD[10]	68	I/O	bit 10 of multiplexed PCI address and data PCI pad; 3.3 V signaling
AD[9]	69	I/O	bit 9 of multiplexed PCI address and data PCI pad; 3.3 V signaling

Table 2: Pin description...continued

Symbol [1]	Pin	Type	Description
REG1V8	70	-	1.8 V regulator output voltage; only for voltage conditioning; cannot be used to supply power to external components; add a 100 nF decoupling capacitor
AD[8]	71	I/O	bit 8 of multiplexed PCI address and data PCI pad; 3.3 V signaling
C/BE#[0]	72	I/O	byte 0 of multiplexed PCI bus command and byte enable PCI pad; 3.3 V signaling
GND A	73	-	analog ground
AD[7]	74	I/O	bit 7 of multiplexed PCI address and data PCI pad; 3.3 V signaling
AD[6]	75	I/O	bit 6 of multiplexed PCI address and data PCI pad; 3.3 V signaling
GND D	76	-	digital ground
AD[5]	77	I/O	bit 5 of multiplexed PCI address and data PCI pad; 3.3 V signaling
AD[4]	78	I/O	bit 4 of multiplexed PCI address and data PCI pad; 3.3 V signaling
AD[3]	79	I/O	bit 3 of multiplexed PCI address and data PCI pad; 3.3 V signaling
AD[2]	80	I/O	bit 2 of multiplexed PCI address and data PCI pad; 3.3 V signaling
AD[1]	81	I/O	bit 1 of multiplexed PCI address and data PCI pad; 3.3 V signaling
AD[0]	82	I/O	bit 0 of multiplexed PCI address and data PCI pad; 3.3 V signaling
V _{CC(I/O)}	83	-	3.3 V supply voltage; used to power pads; add a 100 nF decoupling capacitor
GND A	84	-	analog ground
AUX1V8	85	-	1.8 V auxiliary output voltage; only for voltage conditioning; cannot be used to supply power to external components; add a 100 nF decoupling capacitor
XTAL1	86	AI	crystal oscillator input; this can also be a 12 MHz or 48 MHz clock input
XTAL2	87	AO	crystal oscillator output (12 MHz); leave open when clock is used
GND D	88	-	digital ground
AMB3	89	I/O	amber LED indicator output for the USB downstream port 3; the LED is off by default and can be programmed to enable it to blink; input as port indicator enable during reset; by default, pull up is enabled; if no LEDs are used, then connect this pin to ground, that is, no port indicator support 3.3 V bidirectional pad; three-state output; 3 ns slew-rate control; input; CMOS; open-drain
GRN3	90	O	green LED indicator output for the USB downstream port 3; the LED is off by default and can be programmed to enable it to blink 3.3 V output pad; 3 ns slew rate control; CMOS; open-drain

Table 2: Pin description...continued

Symbol [1]	Pin	Type	Description
AMB2	91	O	amber LED indicator output for the USB downstream port 2; the LED is off by default and can be programmed to enable it to blink 3.3 V output pad; 3 ns slew rate control; CMOS; open-drain
GRN2	92	O	green LED indicator output for the USB downstream port 2; the LED is off by default and can be programmed to enable it to blink 3.3 V output pad; 3 ns slew rate control; CMOS; open-drain
AMB1	93	O	amber LED indicator output for the USB downstream port 1; the LED is off by default and can be programmed to enable it to blink 3.3 V output pad; 3 ns slew rate control; CMOS; open-drain
GRN1	94	O	green LED indicator output for the USB downstream port 1; the LED is off by default and can be programmed to enable it to blink 3.3 V output pad; 3 ns slew rate control; CMOS; open-drain
V _{CC(I/O)_AUX}	95	-	3.3 V auxiliary supply voltage; used to power pads; add a 100 nF decoupling capacitor
OC1_N	96	I	overcurrent sense input for the USB downstream port 1 (digital) 3.3 V input pad; push-pull; CMOS
PWE1_N	97	O	power enable for the USB downstream port 1 3.3 V output pad; 3 ns slew rate control; CMOS; open-drain
GND_A	98	-	analog ground
RREF	99	AI/O	analog connection for the external resistor (12 kΩ ± 1 %)
GND_A	100	-	analog ground
DM1	101	AI/O	D ⁻ ; analog connection for the USB downstream port 1; leave this pin open when not in use
GND_A	102	-	analog ground
DP1	103	AI/O	D ⁺ ; analog connection for the USB downstream port 1; leave this pin open when not in use
V _{DDA_AUX}	104	-	auxiliary analog supply voltage; add a 100 nF decoupling capacitor
OC2_N	105	I	overcurrent sense input for the USB downstream port 2 (digital) 3.3 V input pad; push-pull; CMOS
PWE2_N	106	O	power enable for the USB downstream port 2 3.3 V output pad; 3 ns slew rate control; CMOS; open-drain
GND_A	107	-	analog ground
DM2	108	AI/O	D ⁻ ; analog connection for the USB downstream port 2; leave this pin open when not in use
GND_A	109	-	analog ground
DP2	110	AI/O	D ⁺ ; analog connection for the USB downstream port 2; leave this pin open when not in use
V _{DDA_AUX}	111	-	auxiliary analog supply voltage; add a 100 nF decoupling capacitor
OC3_N	112	I	overcurrent sense input for the USB downstream port 3 (digital) 3.3 V input pad; push-pull; CMOS
PWE3_N	113	O	power enable for the USB downstream port 3 3.3 V output pad; 3 ns slew rate control; CMOS; open-drain
OC4_N	114	I	overcurrent sense input for the USB downstream port 4 (digital) 3.3 V input pad; push-pull; CMOS

Table 2: Pin description...continued

Symbol ^[1]	Pin	Type	Description
PWE4_N	115	O	power enable for the USB downstream port 4 3.3 V output pad; 3 ns slew rate control; CMOS; open-drain
GND_A	116	-	analog ground
DM3	117	AI/O	D-; analog connection for the USB downstream port 3; leave this pin open when not in use
GND_A	118	-	analog ground
DP3	119	AI/O	D+; analog connection for the USB downstream port 3; leave this pin open when not in use
V _{DDA_AUX}	120	-	auxiliary analog supply voltage; add a 100 nF decoupling capacitor
SEL48M	121	I	selection between 12 MHz crystal and 48 MHz oscillator: <ul style="list-style-type: none"> • LOW: 12 MHz crystal is used • HIGH: 48 MHz clock is used. 3.3 V input pad; push-pull; CMOS
SCL	122	I/O	I ² C-bus clock; pull-up to 3.3 V through a 10 kΩ resistor ^[3] I ² C-bus pad; clock signal
SDA	123	I/O	I ² C-bus data; pull-up to 3.3 V through a 10 kΩ resistor ^[3] I ² C-bus pad; data signal
GND_A	124	-	analog ground
DM4	125	AI/O	D-; analog connection for the USB downstream port 4; leave this pin open when not in use
GND_A	126	-	analog ground
DP4	127	AI/O	D+; analog connection for the USB downstream port 4; leave this pin open when not in use
V _{DDA_AUX}	128	-	auxiliary analog supply voltage; add a 100 nF decoupling capacitor

[1] Symbol names ending with '#', for example, NAME#, represent active LOW signals for PCI pins. Symbol names ending with underscore N, for example, NAME_N, represent active LOW signals for USB pins.

[2] If legacy support is not used, connect this pin to ground.

[3] Connect to ground if I²C-bus is not used.



7. Functional description

7.1 OHCI Host Controller

An OHCI Host Controller transfers data to devices at the Original USB defined bit rate of 12 Mbit/s or 1.5 Mbit/s.

7.2 EHCI Host Controller

The EHCI Host Controller transfers data to a Hi-Speed USB compliant device at the Hi-Speed USB defined bit rate of 480 Mbit/s. When the EHCI Host Controller has the ownership of a port, the OHCI Host Controllers are not allowed to modify the port register. All additional port bit definitions required for the Enhanced Host Controller are not visible to the OHCI Host Controller.

7.3 Dynamic port-routing logic

The port-routing feature allows sharing of the same physical downstream ports between the Original USB Host Controller and the Hi-Speed USB Host Controller. This requirement of the *Enhanced Host Controller Interface Specification for Universal Serial Bus Rev. 1.0* provides four downstream ports, and these ports are multiplexed with the ports of the two OHCI. The first and third downstream ports are always connected to the first OHCI, and the second and fourth downstream ports are always connected to the second OHCI.

The EHCI is responsible for the port-routing switching mechanism. Two register bits are used for ownership switching. During power-on and system reset, the default ownership of all downstream ports is the OHCI. The Enhanced Host Controller Driver (HCD) controls the ownership during normal functionality.

7.4 Hi-Speed USB analog transceivers

The Hi-Speed USB analog transceivers directly interface to the USB cables through integrated termination resistors. These transceivers can transmit and receive serial data at all data rates: high-speed (480 Mbit/s), full-speed (12 Mbit/s) and low-speed (1.5 Mbit/s).

7.5 LED indicators for downstream ports

The system designer can program two optional port indicators, a green LED and an amber LED, to indicate the status of the Host Controller. These port indicators are implemented according to the USB specification.

All LED indicators are open-drain output.

7.6 Power management

The ISP1563 provides an advanced power management capability interface that is compliant with *PCI Bus Power Management Interface Specification Rev. 1.1*. Power is controlled and managed by the interaction between drivers and PCI registers.

For a detailed description on power management, see [Section 10](#).

7.7 Legacy support

The ISP1563 provides legacy support for a USB keyboard and mouse. This means that the keyboard and mouse should be able to work even before the Operating System (OS) boot-up, with the necessary support in the Basic Input Output System (BIOS).

[Section 11.2](#) provides a detailed description on the legacy support in the ISP1563.

7.8 Phase-Locked Loop (PLL)

A 12 MHz-to-30 MHz and 48 MHz clock multiplier PLL is integrated on-chip. This allows the use of a low-cost 12 MHz crystal, which also minimizes EMI. No external components are required for the PLL to operate.

7.9 Power-On Reset (POR)

[Figure 3](#) shows a possible curve of $V_{CC(I/O)}$ with dips at t_2 to t_3 and t_4 to t_5 . At t_0 , POR will start with 1. At t_1 , the detector passes through the trip level. Another delay will be added before POR drops to 0 to ensure that the length of the generated detector pulse, POR, is large enough to reset asynchronous flip-flops. If the dip is too short (t_4 to $t_5 < 11 \mu\text{s}$), POR will not react and will stay LOW.

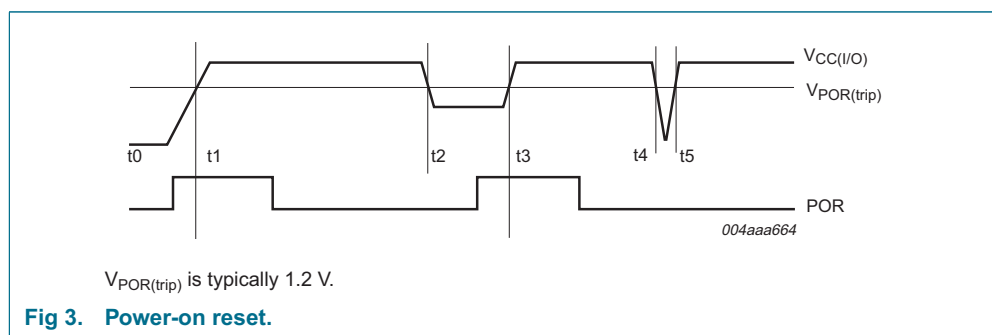

7.10 Power supply

[Figure 4](#) shows the ISP1563 power supply connection.

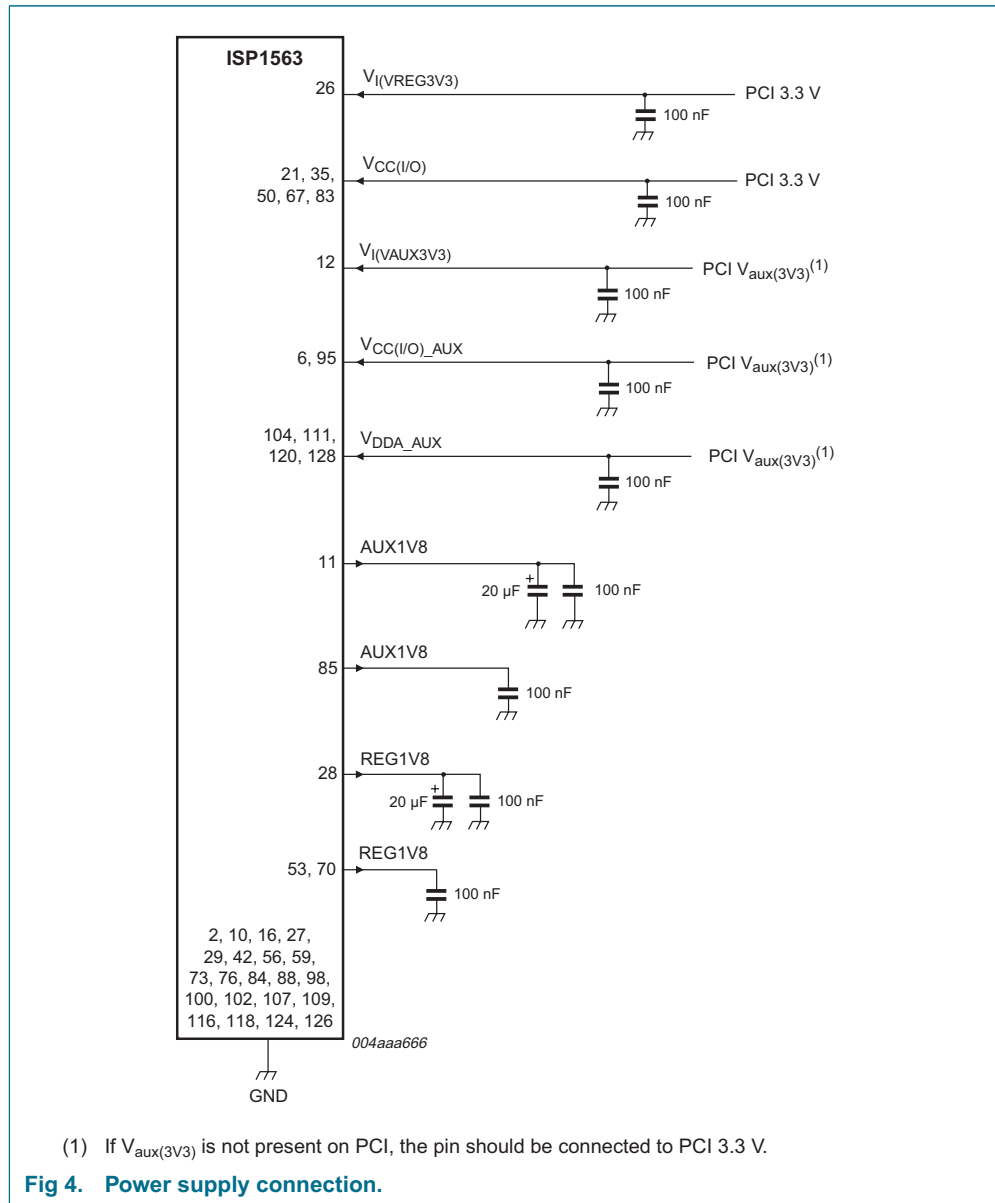

8. PCI

8.1 PCI interface

The PCI interface has three functions. The first function (#0) and the second function (#1) are for the OHCI Host Controllers, and the third function (#2) is for the EHCI Host Controller. All functions support both master and target accesses, and share the same PCI interrupt signal INTA#. These functions provide memory-mapped, addressable operational registers as required in *Open Host Controller Interface Specification for USB Rev. 1.0a* and *Enhanced Host Controller Interface Specification for Universal Serial Bus Rev. 1.0*.

Additionally, function #0 provides legacy keyboard and mouse support to comply with *Open Host Controller Interface Specification for USB Rev. 1.0a*.

Each function has its own configuration space. The PCI enumerator should allocate the memory address space for each of these functions. Power management is implemented in each PCI function and all power states are provided. This allows the system to achieve low power consumption by switching off the functions that are not required.

8.1.1 PCI configuration space

PCI Local Bus Specification Rev. 2.2 requires that each of the three PCI functions of the ISP1563 provides its own PCI configuration registers, which can vary in size. In addition to the basic PCI configuration header registers, these functions implement capability registers to support power management.

The registers of each of these functions are accessed by the respective driver. [Section 8.2](#) provides a detailed description of the various PCI configuration registers.

8.1.2 PCI initiator and target

A PCI initiator initiates PCI transactions to the PCI bus. A PCI target responds to PCI transactions as a slave. In the case of the ISP1563, the two Open Host Controllers and the Enhanced Host Controller function as both initiators or targets of PCI transactions issued by the host CPU.

All USB Host Controllers have their own operational registers that can be accessed by the system driver software. Drivers use these registers to configure the Host Controller hardware system, issue commands to it, and monitor the status of the current hardware operation. The Host Controller plays the role of a PCI target. All operational registers of the Host Controllers are the PCI transaction targets of the CPU.

Normal USB transfers require the Host Controller to access system memory fields, which are allocated by USB HCDs and PCI drivers. The Host Controller hardware interacts with the HCD by accessing these buffers. The Host Controller works as an initiator in this case, and becomes a PCI master.

8.2 PCI configuration registers

The OHCI USB Host Controllers and the EHCI USB Host Controller contain two sets of software-accessible hardware registers: PCI configuration registers and memory-mapped Host Controller registers.

A set of configuration registers is implemented for each of the three PCI functions of the ISP1563, see [Table 3](#).

Remark: In addition to the normal PCI header, from offset index 00h to 3Fh, implementation-specific registers are defined to support power management and function-specific features.

Table 3: PCI configuration space registers of OHCI1, OHCI2 and EHCI

Address	Bits 31 to 24	Bits 23 to 16	Bits 15 to 8	Bits 7 to 0	Reset value ^[1]		
					Func0 OHCI1	Func1 OHCI2	Func2 EHCI
PCI configuration header registers							
00h	Device ID[15:0]		Vendor ID[15:0]		1561 1131h	1561 1131h	1562 1131h
04h	Status[15:0]		Command[15:0]		0210 0000 h	0210 0000 h	0210 0000 h
08h	Class Code[23:0]			Revision ID[7:0]	0C03 1011h	0C03 1011h	0C03 2011h
0Ch	reserved	Header Type[7:0]	Latency Timer[7:0]	CacheLine Size[7:0]	0080 0000 h	0080 0000 h	0080 0000 h
10h	Base Address 0[31:0]				0000 0000 h	0000 0000 h	0000 0000 h
14h	reserved				0000 0000h	0000 0000h	0000 0000h
18h							
1Ch							
20h							
24h							
28h							
2Ch	Subsystem ID[15:0]		Subsystem Vendor ID[15:0]		1561 1131h	1561 1131h	1562 1131h
30h	reserved				-	-	-
34h	reserved			Capabilities Pointer[7:0]	0000 00DCh	0000 00DCh	0000 00DCh
38h	reserved				0000 0000h	0000 0000h	0000 0000h
3Ch	Max_Lat[7:0]	Min_Gnt[7:0]	Interrupt Pin[7:0]	Interrupt Line[7:0]	2A01 0100 h	2A01 0100 h	1002 0100 h
40h	reserved		Retry Timeout	TRDY Timeout	0000 8000 h	0000 8000 h	0000 8000 h
Enhanced Host Controller-specific PCI registers							
60h	PORTWAKECAP[15:0]		FLADJ[7:0]	SBRN[7:0]	-	-	00XX 2020 h ^[2]
Power management registers							
DCh	PMC[15:0]		Next_Item_Ptr [7:0]	Cap_ID[7:0]	D282 0001h	D282 0001h	FF82 0001h
E0h	Data[7:0]	PMCSR_BSE [7:0]	PMCSR[15:0]		0000 XX00 h	0000 XX00 h	0000 XX00 h ^[3]

[1] Reset values that are highlighted, for example, **0**, indicate read and write accesses; and reset values that are not highlighted, for example, 0, indicate read-only.

[2] XX is 1Fh for four ports and 07h for two ports.

[3] See [Section 8.2.3.4](#).

The HCD does not usually interact with the PCI configuration space. The configuration space is used only by the PCI enumerator to identify the USB Host Controller and assign appropriate system resources by reading the Vendor ID (VID) and the Device ID (DID).

8.2.1 PCI configuration header registers

The Enhanced Host Controller implements the normal PCI header register values, except the values for the memory-mapping base address register, serial bus number and Device ID.

8.2.1.1 Vendor ID register

This read-only register identifies the manufacturer of the device. PCI Special Interest Group (PCI-SIG) assigns valid vendor identifiers to ensure the uniqueness of the identifier. The bit description is shown in [Table 4](#).

Table 4: VID - Vendor ID register (address 00h) bit description

Legend: * reset value

Bit	Symbol	Access	Value	Description
15 to 0	VID[15:0]	R	1131h*	Vendor ID: This read-only register value is assigned to Philips Semiconductors by PCI-SIG as 1131h.

8.2.1.2 Device ID register

This is a 2 B read-only register that identifies a particular device. The identifier is allocated by Philips Semiconductors. [Table 5](#) shows the bit description of the register.

Table 5: DID - Device ID register (address 02h) bit description

Legend: * reset value

Bit	Symbol	Access	Value	Description
15 to 0	DID[15:0]	R	156Xh* ^[1]	Device ID: This register value is defined by Philips Semiconductors to identify the USB Host Controller IC product.

[1] X is 1h for OHCI1 and OHCI2; X is 2h for EHCI.

8.2.1.3 Command register

This is a 2 B register that provides coarse control over the ability of a device to generate and respond to PCI cycles. The bit allocation of the Command register is given in [Table 6](#). When logic 0 is written to this register, the device is logically disconnected from the PCI bus for all accesses, except configuration accesses. All devices are required to support this base level of functionality. Individual bits in the Command register may or may not support this base level of functionality.

Table 6: Command register (address 04h) bit allocation

Bit	15	14	13	12	11	10	9	8
Symbol	reserved ^[1]						FBBE	SERRE
Reset	0	0	0	0	0	0	0	0
Access	R/W	R/W	R/W	R/W	R/W	R/W	R/W	R/W
Bit	7	6	5	4	3	2	1	0
Symbol	SCTRL	PER	VGAPS	MWIE	SC	BM	MS	IOS
Reset	0	0	0	0	0	0	0	0
Access	R	R/W	R	R/W	R	R/W	R/W	R/W

[1] The reserved bits should always be written with the reset value.

Table 7: Command register (address 04h) bit description

Bit	Symbol	Description
15 to 10	reserved	-
9	FBBE	<p>Fast Back-to-Back Enable: This bit controls whether a master can do fast back-to-back transactions to various devices. The initialization software must set this bit if all targets are fast back-to-back capable.</p> <p>0 — Fast back-to-back transactions are only allowed to the same agent (value after RST#)</p> <p>1 — The master is allowed to generate fast back-to-back transactions to different agents.</p>
8	SERRE	<p>SERR# Enable: This bit is an enable bit for the SERR# driver. All devices that have an SERR# pin must implement this bit. Address parity errors are reported only if this bit and the PER bit are logic 1.</p> <p>0 — Disable the SERR# driver</p> <p>1 — Enable the SERR# driver.</p>
7	SCTRL	<p>Stepping Control: This bit controls whether a device does address and data stepping. Devices that never do stepping must clear this bit. Devices that always do stepping must set this bit. Devices that can do either, must make this bit read and write, and initialize it to logic 1 after RST#.</p>
6	PER	<p>Parity Error Response: This bit controls the response of a device to parity errors. When the bit is set, the device must take its normal action when a parity error is detected. When the bit is logic 0, the device sets DPE (bit 15 in the Status register) when an error is detected, but does not assert PERR# and continues normal operation. The state of this bit after RST# is logic 0. Devices that check parity must implement this bit. Devices are required to generate parity, even if parity checking is disabled.</p>
5	VGAPS	<p>VGA Palette Snoop: This bit controls how Video Graphics Array (VGA) compatible and graphics devices handle accesses to VGA palette registers.</p> <p>0 — The device should treat palette write accesses like all other accesses.</p> <p>1 — Palette snooping is enabled, that is, the device does not respond to palette register writes and snoops data.</p> <p>VGA compatible devices should implement this bit.</p>
4	MWIE	<p>Memory Write and Invalidate Enable: This is an enable bit for using the Memory Write and Invalidate command.</p> <p>0 — Memory Writes must be used instead. State after RST# is logic 0.</p> <p>1 — Masters may generate the command.</p> <p>This bit must be implemented by master devices that can generate the Memory Write and Invalidate command.</p>
3	SC	<p>Special Cycles: Controls the action of a device on Special Cycle operations.</p> <p>0 — Causes the device to ignore all Special Cycle operations. State after RST# is logic 0.</p> <p>1 — Allows the device to monitor Special Cycle operations.</p>

Table 7: Command register (address 04h) bit description...continued

Bit	Symbol	Description
2	BM	Bus Master: Controls the ability of a device to act as a master on the PCI bus. 0 — Disables the device from generating PCI accesses. State after RST# is logic 0. 1 — Allows the device to behave as a bus master.
1	MS	Memory Space: Controls the response of a device to Memory Space accesses. 0 — Disables the device response. State after RST# is logic 0. 1 — Allows the device to respond to Memory Space accesses.
0	IOS	I/O Space: Controls the response of a device to I/O space accesses. 0 — Disables the device response. State after RST# is logic 0. 1 — Allows the device to respond to I/O space accesses.

8.2.1.4 Status register

The Status register is a 2 B read-only register used to record status information on PCI bus-related events. For bit allocation, see [Table 8](#).

Table 8: Status register (address 06h) bit allocation

Bit	15	14	13	12	11	10	9	8
Symbol	DPE	SSE	RMA	RTA	STA	DEVSEL[1:0]		MDPE
Reset	0	0	0	0	0	0	1	0
Access	R	R	R	R	R	R	R	R
Bit	7	6	5	4	3	2	1	0
Symbol	FBBC	reserved	66MC	CL	reserved			
Reset	0	0	0	1	0	0	0	0
Access	R	R	R	R	R	R	R	R

Table 9: Status register (address 06h) bit description

Bit	Symbol	Description
15	DPE	Detected Parity Error: This bit must be set by the device whenever it detects a parity error, even if the parity error handling is disabled.
14	SSE	Signaled System Error: This bit must be set whenever the device asserts SERR#. Devices that never assert SERR# do not need to implement this bit.
13	RMA	Received Master Abort: This bit must be set by a master device whenever its transaction, except for Special Cycle, is terminated with Master-Abort. All master devices must implement this bit.

Table 9: Status register (address 06h) bit description...continued

Bit	Symbol	Description
12	RTA	Received Target Abort: This bit must be set by a master device whenever its transaction is terminated with Target-Abort. All master devices must implement this bit.
11	STA	Signaled Target Abort: This bit must be set by a target device whenever it terminates a transaction with Target-Abort. Devices that never signal Target-Abort do not need to implement this bit.
10 to 9	DEVSELT [1:0]	DEVSEL Timing: These bits encode the timing of DEVSEL#. There are three allowable timing to assert DEVSEL#: 00b — Fast 01b — Medium 10b — Slow 11b — Reserved. These bits are read-only and must indicate the slowest time that a device asserts DEVSEL# for any bus command, except Configuration Read and Configuration Write.
8	MDPE	Master Data Parity Error: This bit is implemented by bus masters. It is set when the following three conditions are met: <ul style="list-style-type: none"> The bus agent asserted PERR# itself, on a read; or observed PERR# asserted, on a write. The agent setting the bit acted as the bus master for the operation in which error occurred. PER (bit 6 in the Command register) is set.
7	FBBC	Fast Back-to-Back Capable: This read-only bit indicates whether the target is capable of accepting fast back-to-back transactions when the transactions are not to the same agent. This bit can be set to logic 1, if the device can accept these transactions; and must be set to logic 0 otherwise.
6	reserved	-
5	66MC	66 MHz Capable: This read-only bit indicates whether this device is capable of running at 66 MHz. 0 — 33 MHz 1 — 66 MHz.
4	CL	Capabilities List: This read-only bit indicates whether this device implements the pointer for a new capabilities linked list at offset 34h. 0 — No new capabilities linked list is available 1 — The value read at offset 34h is a pointer in configuration space to a linked list of new capabilities.
3 to 0	reserved	-

8.2.1.5 Revision ID register

This 1 B read-only register indicates a device-specific revision identifier. The value is chosen by the vendor. This field is a vendor-defined extension of the Device ID. The Revision ID register bit description is given in [Table 10](#).

Table 10: REVID - Revision ID register (address 08h) bit description

Legend: * reset value

Bit	Symbol	Access	Value	Description
7 to 0	REVID[7:0]	R	11h*	Revision ID: This byte specifies the design revision number of functions.

8.2.1.6 Class Code register

Class Code is a 24-bit read-only register used to identify the generic function of the device, and in some cases, a specific register-level programming interface. [Table 11](#) shows the bit allocation of the register.

The Class Code register is divided into three byte-size fields. The upper byte is a base class code that broadly classifies the type of function the device performs. The middle byte is a sub-class code that identifies more specifically the function of the device. The lower byte identifies a specific register-level programming interface, if any, so that device-independent software can interact with the device.

Table 11: Class Code register (address 09h) bit allocation

Bit	23	22	21	20	19	18	17	16
Symbol	BCC[7:0]							
Reset	0Ch							
Access	R	R	R	R	R	R	R	R
Bit	15	14	13	12	11	10	9	8
Symbol	SCC[7:0]							
Reset	03h							
Access	R	R	R	R	R	R	R	R
Bit	7	6	5	4	3	2	1	0
Symbol	RLPI[7:0]							
Reset	X0h ^[1]							
Access	R	R	R	R	R	R	R	R

[1] X is 1h for OHCI1 and OHCI2; X is 2h for EHCI.

Table 12: Class Code register (address 09h) bit description

Bit	Symbol	Description
23 to 16	BCC[7:0]	Base Class Code: 0Ch is the base class code assigned to this byte. It implies a serial bus controller.
15 to 8	SCC[7:0]	Sub-Class Code: 03h is the sub-class code assigned to this byte. It implies the USB Host Controller.
7 to 0	RLPI[7:0]	Register-Level Programming Interface: 10h is the programming interface code assigned to OHCI, which is USB 1.1 specification compliant. 20h is the programming interface code assigned to EHCI, which is USB 2.0 specification compliant.

8.2.1.7 CacheLine Size register

The CacheLine Size register is a read and write single-byte register that specifies the system CacheLine size in units of DWords. This register must be implemented by master devices that can generate the Memory Write and Invalidate command. The value in this register is also used by master devices to determine whether to use Read, Read Line or Read Multiple commands to access the memory.

Slave devices that want to allow memory bursting using a CacheLine-wrap addressing mode must implement this register to know when a burst sequence wraps to the beginning of the CacheLine.

This field must be initialized to logic 0 on activation of RST#. [Table 13](#) shows the bit description of the CacheLine Size register.

Table 13: CLS - CacheLine Size register (address 0Ch) bit description

Legend: * reset value

Bit	Symbol	Access	Value	Description
7 to 0	CLS[7:0]	R/W	00h*	CacheLine Size: This byte identifies the system CacheLine size.

8.2.1.8 Latency Timer register

This register specifies, in units of PCI bus clocks, the value of the Latency Timer for the PCI bus master. [Table 14](#) shows the bit description of the Latency Timer register.

Table 14: LT - Latency Timer register (address 0Dh) bit description

Legend: * reset value

Bit	Symbol	Access	Value	Description
7 to 0	LT[7:0]	R/W	00h*	Latency Timer: This byte identifies the latency timer.

8.2.1.9 Header Type register

The Header Type register identifies the layout of the second part of the predefined header; beginning at byte 10h in configuration space. It also identifies whether the device contains multiple functions. For bit allocation, see [Table 15](#).

Table 15: Header Type register (address 0Eh) bit allocation

Bit	7	6	5	4	3	2	1	0
Symbol	MFD	HT[6:0]						
Reset	1	0	0	0	0	0	0	0
Access	R	R	R	R	R	R	R	R

Table 16: Header Type register (address 0Eh) bit description

Bit	Symbol	Description
7	MFD	Multi-Function Device: This bit identifies a multifunction device. 0 — The device has single function. 1 — The device has multiple functions.
6 to 0	HT[6:0]	Header Type: These bits identify the layout of the part of the predefined header, beginning at byte 10h in configuration space.

8.2.1.10 Base Address register 0

Power-up software must build a consistent address map before booting the machine to an operating system. This means it must determine how much memory is in the system, and how much address space the I/O controllers in the system require. After determining this information, power-up software can map the I/O controllers into reasonable locations and proceed with system boot. To do this mapping in a device-independent manner, the base registers for this mapping are placed in the predefined header portion of configuration space.

Bit 0 in all Base Address registers is read-only and used to determine whether the register maps into memory or I/O space. Base Address registers that map to memory space must return logic 0 in bit 0. Base Address registers that map to I/O space must return logic 1 in bit 0.

The bit description of the BAR 0 register is given in [Table 17](#).

Table 17: BAR 0 - Base Address register 0 (address 10h) bit description

Legend: * reset value

Bit	Symbol	Access	Value	Description
31 to 0	BAR 0[31:0]	R/W	0000 0000h*	Base Address to Memory-Mapped Host Controller Register Space: The memory size required by OHCI and EHCI are 4 kB and 256 B, respectively. Therefore, BAR 0[31:12] is assigned to the two OHCI ports, and BAR 0[31:8] is assigned to the EHCI port.

8.2.1.11 Subsystem Vendor ID register

The Subsystem Vendor ID register is used to uniquely identify the expansion board or subsystem where the PCI device resides. This register allows expansion board vendors to distinguish their boards, even though the boards may have the same Vendor ID and Device ID.

Subsystem Vendor IDs are assigned by PCI-SIG to maintain uniqueness. The bit description of the Subsystem Vendor ID register is given in [Table 18](#).

Table 18: SVID - Subsystem Vendor ID register (address 2Ch) bit description

Legend: * reset value

Bit	Symbol	Access	Value	Description
15 to 0	SVID[15:0]	R	1131h*	Subsystem Vendor ID: 1131h is the subsystem Vendor ID assigned to Philips Semiconductors.

8.2.1.12 Subsystem ID register

Subsystem ID values are vendor specific. The bit description of the Subsystem ID register is given in [Table 19](#).

Table 19: SID - Subsystem ID register (address 2Eh) bit description

Legend: * reset value

Bit	Symbol	Access	Value	Description
15 to 0	SID[15:0]	R	156Xh* ^[1]	Subsystem ID: For the ISP1563, Philips Semiconductors has defined OHCI functions as 1561h, and the EHCI function as 1562h.

[1] X is 1h for OHCI1 and OHCI2; X is 2h for EHCI.

8.2.1.13 Capabilities Pointer register

This register is used to point to a linked list of new capabilities implemented by the device. This register is only valid if CL (bit 4 in the Status register) is set. If implemented, bit 1 and bit 0 are reserved and should be set to 00b. Software should mask these bits off before using this register as a pointer in configuration space to the first entry of a linked list of new capabilities. The bit description of the register is given in [Table 20](#).

Table 20: CP - Capabilities Pointer register (address 34h) bit description

Legend: * reset value

Bit	Symbol	Access	Value	Description
7 to 0	CP[7:0]	R	DCh*	Capabilities Pointer: EHCI efficiently manages power using this register. This Power Management register is allocated at offset DCh. Only one Host Controller is needed to manage power in the ISP1563.

8.2.1.14 Interrupt Line register

This is a 1 B register used to communicate interrupt line routing information. This register must be implemented by any device or device function that uses an interrupt pin. The interrupt allocation is done by the BIOS. The Power On Self Test (POST) software needs to write the routing information to this register because it initializes and configures the system. The value in this register specifies which input of the system interrupt controller(s) the interrupt pin of the device is connected. This value is used by device drivers and operating systems to determine priority and vector information. Values in this register are system architecture specific. The bit description of the register is given in [Table 21](#).

Table 21: IL - Interrupt Line register (address 3Ch) bit description

Legend: * reset value

Bit	Symbol	Access	Value	Description
7 to 0	IL[7:0]	R/W	00h*	Interrupt Line: Indicates which IRQ is used to report interrupt from the ISP1563.

8.2.1.15 Interrupt Pin register

This 1 B register is use to specify which interrupt pin the device or device function uses.

A value of 1h corresponds to INTA#, 2h corresponds to INTB#, 3h corresponds to INTC#, and 4h corresponds to INTD#. Devices or functions that do not use interrupt pin must set this register to logic 0. The bit description is given in [Table 22](#).

Table 22: IP - Interrupt Pin register (address 3Dh) bit description

Legend: * reset value

Bit	Symbol	Access	Value	Description
7 to 0	IP[7:0]	R	01h*	Interrupt Pin: INTA# is the default interrupt pin used by the ISP1563.

8.2.1.16 Min_Gnt and Max_Lat registers

The Minimum Grant (Min_Gnt) and Maximum Latency (Max_Lat) registers are used to specify the desired settings of the device for latency timer values. For both registers, the value specifies a period of time in units of 250 ns. Logic 0 indicates that the device has no major requirements for setting latency timers. The Min_Gnt register bit description is given in [Table 23](#).

Table 23: Min_Gnt - Minimum Grant register (address 3Eh) bit description

Legend: * reset value

Bit	Symbol	Access	Value	Description
7 to 0	MIN_GNT [7:0]	R	0Xh* ^[1]	Min_Gnt: It is used to specify how long a burst period the device needs, assuming a clock rate of 33 MHz.

[1] X is 1h for OHCI1 and OHCI2; X is 2h for EHCI.

The Max_Lat register bit description is given in [Table 24](#).

Table 24: Max_Lat - Maximum Latency register (address 3Fh) bit description

Legend: * reset value

Bit	Symbol	Access	Value	Description
7 to 0	MAX_LAT[7:0]	R	XXh* ^[1]	Max_Lat: It is used to specify how often the device needs to gain access to the PCI bus.

[1] XX is 2Ah for OHCI1 and OHCI2; XX is 10h for EHCI.

8.2.1.17 TRDY Timeout register

This is a read and write register at address 40h. The default and recommended value is 00h; TRDY Timeout disabled. This value can, however, be modified. It is an implementation-specific register, and not a standard PCI configuration register.

The TRDY timer is 13 bits. The lower 5 bits are fixed as logic 0 and the upper 8 bits are determined by the TRDY Timeout register value. The time-out is calculated by multiplying the 13-bit timer with the PCI CLK cycle time.

This register determines the maximum TRDY delay without asserting the UE (Unrecoverable Error) bit. If TRDY is longer than the delay determined by this register value, then the UE bit will be set.

8.2.1.18 Retry Timeout register

The default value of this read and write register is 80h, and is located at address 41h. This value can, however, be modified. Programming this register as 00h means that retry time-out is disabled. This is an implementation-specific register, and not a standard PCI configuration register.

The time-out is determined by multiplying the register value with the PCI CLK cycle time. This register determines the maximum number of PCI retries before the UE bit is set. If the number of retries is longer than the delay determined by this register value, then the UE bit will be set.

8.2.2 Enhanced Host Controller-specific PCI registers

In addition to the PCI configuration header registers, EHCI needs some additional PCI configuration space registers to indicate the serial bus release number, downstream port wake-up event capability, and adjust the USB bus frame length for Start-of-Frame (SOF). The EHCI-specific PCI registers are given in [Table 25](#).

Table 25: EHCI-specific PCI registers

Offset	Register
60h	Serial Bus Release Number (SBRN)
61h	Frame Length Adjustment (FLADJ)
62h to 63h	Port Wake Capability (PORTWAKECAP)

8.2.2.1 SBRN register

The Serial Bus Release Number (SBRN) register is a 1 B register, and the bit description is given in [Table 26](#). This register contains the release number of the USB specification with which this USB Host Controller module is compliant.

Table 26: SBRN - Serial Bus Release Number register (address 60h) bit description

Legend: * reset value

Bit	Symbol	Access	Value	Description
7 to 0	SBRN[7:0]	R	20h*	Serial Bus Specification Release Number: This register value is to identify Serial Bus Specification Rev. 2.0. All other combinations are reserved.

8.2.2.2 FLADJ register

This feature is used to adjust any offset from the clock source that generates the clock that drives the SOF counter. When a new value is written to these six bits, the length of the frame is adjusted. The bit allocation of the Frame Length Adjustment (FLADJ) register is given in [Table 27](#).

Table 27: FLADJ - Frame Length Adjustment register (address 61h) bit allocation

Bit	7	6	5	4	3	2	1	0
Symbol	reserved ^[1]		FLADJ[5:0]					
Reset	0	0	1	0	0	0	0	0
Access	R/W	R/W	R/W	R/W	R/W	R/W	R/W	R/W

[1] The reserved bits should always be written with the reset value.

Table 28: FLADJ - Frame Length Adjustment register (address 61h) bit description

Bit	Symbol	Description
7 to 6	reserved	-
5 to 0	FLADJ[5:0]	Frame Length Timing Value: Each decimal value change to this register corresponds to 16 high-speed bit times. The SOF cycle time (number of SOF counter clock periods to generate a SOF micro frame length) is equal to 59488 + value in this field. The default value is decimal 32 (20h), which gives a SOF cycle time of 60000.
		FLADJ value
		SOF cycle time (480 MHz)
		0 (00h)
		59488
		1 (01h)
		59504
		2 (02h)
		59520
		:
		:
		31 (1Fh)
		59984
		32 (20h)
		60000
		:
		:
		62 (3Eh)
		60480
		63 (3Fh)
		60496

8.2.2.3 PORTWAKECAP register

Port Wake Capability (PORTWAKECAP) is a 2 B register used to establish a policy about which ports are for wake events; see [Table 29](#). Bit positions 15 to 1 in the mask correspond to a physical port implemented on the current EHCI controller. Logic 1 in a bit position indicates that a device connected below the port can be enabled as a wake-up device and the port may be enabled for disconnect or connect, or overcurrent events as wake-up events. This is an information only mask register. The bits in this register do not affect the actual operation of the EHCI Host Controller. The system-specific policy can be

established by BIOS initializing this register to a system-specific value. The system software uses the information in this register when enabling devices and ports for remote wake-up.

Table 29: PORTWAKECAP - Port Wake Capability register (address 62h) bit description

Legend: * reset value

Bit	Symbol	Access	Value	Description
15 to 0	PORTWAKECAP[15:0]	R/W	001Fh*	Port Wake-Up Capability Mask: EHCI does not implement this feature.

8.2.3 Power management registers

Table 30: Power Management registers

Offset	Register
Value read from address 34h + 0h	Capability Identifier (Cap_ID)
Value read from address 34h + 1h	Next Item Pointer (Next_Item_Ptr)
Value read from address 34h + 2h	Power Management Capabilities (PMC)
Value read from address 34h + 4h	Power Management Control/Status (PMCSR)
Value read from address 34h + 6h	Power Management Control/Status PCI-to-PCI Bridge Support Extensions (PMCSR_BSE)
Value read from address 34h + 7h	Data

8.2.3.1 Cap_ID register

The Capability Identifier (Cap_ID) register when read by the system software as 01h indicates that the data structure currently being pointed to is the PCI Power Management data structure. Each function of a PCI device may have only one item in its capability list with Cap_ID set to 01h. The bit description of the register is given in [Table 31](#).

Table 31: Cap_ID - Capability Identifier register bit description

Address: Value read from address 34h + 0h

Legend: * reset value

Bit	Symbol	Access	Value	Description
7 to 0	CAP_ID[7:0]	R	01h*	ID: This field when 01h identifies the linked list item as being PCI Power Management registers.

8.2.3.2 Next_Item_Ptr register

The Next Item Pointer (Next_Item_Ptr) register describes the location of the next item in the function's capability list. The value given is an offset into the function's PCI configuration space. If the function does not implement any other capabilities defined by the PCI-SIG for inclusion in the capabilities list, or if power management is the last item in the list, then this register must be set to 00h. See [Table 32](#).

Table 32: Next_Item_Ptr - Next Item Pointer register bit description

Address: Value read from address 34h + 1h

Legend: * reset value

Bit	Symbol	Access	Value	Description
7 to 0	NEXT_ITEM_PTR[7:0]	R	00h*	Next Item Pointer: This field provides an offset into the function's PCI configuration space pointing to the location of the next item in the function's capability list. If there are no additional items in the Capabilities List, this register is set to 00h.

8.2.3.3 PMC register

The Power Management Capabilities (PMC) register is a 2 B register, and the bit allocation is given in [Table 33](#). This register provides information on the capabilities of the function related to power management.

Table 33: PMC - Power Management Capabilities register bit allocation

Address: Value read from address 34h + 2h

Bit	15	14	13	12	11	10	9	8
Symbol	PME_S[4:0]					D2_S	D1_S	AUX_C
Reset	1	1	X [1]	1	X [1]	X [1]	1	0
Access	R	R	R	R	R	R	R	R
Bit	7	6	5	4	3	2	1	0
Symbol	AUX_C[2:0]		DSI	reserved	PMI	VER[2:0]		
Reset	1	0	0	0	0	0	1	0
Access	R	R	R	R	R	R	R	R

[1] X is 0 for OHCI1 and OHCI2; X is 1 for EHCI.

Table 34: PMC - Power Management Capabilities register bit description

Address: Value read from address 34h + 2h

Bit	Symbol	Description
15 to 11	PME_S[4:0]	PMC_Support: These bits indicate the power states in which the function may assert PME#. Logic 0 for any bit indicates that the function is not capable of asserting the PME# signal while in that power state. PME_S[0] — PME# can be asserted from D0 PME_S[1] — PME# can be asserted from D1 PME_S[2] — PME# can be asserted from D2 PME_S[3] — PME# can be asserted from D3 _{hot} PME_S[4] — PME# can be asserted from D3 _{cold} .
10	D2_S	D2_Support: If this bit is logic 1, this function supports the D2 Power Management State. Functions that do not support D2 must always return logic 0 for this bit.
9	D1_S	D1_Support: If this bit is logic 1, this function supports the D1 Power Management State. Functions that do not support D1 must always return logic 0 for this bit.

Table 34: PMC - Power Management Capabilities register bit description...continued

Address: Value read from address 34h + 2h

Bit	Symbol	Description
8 to 6	AUX_C[2:0]	<p>Auxiliary_Current: This three-bit field reports the $V_{aux(3V3)}$ auxiliary current requirements for the PCI function.</p> <p>If the Data register is implemented by this function:</p> <ul style="list-style-type: none"> A read from this field needs to return a value of 000b. The Data register takes precedence over this field for $V_{aux(3V3)}$ current requirement reporting. <p>If the PME# generation from D3_{cold} is not supported by the function (PMC[15] = 0), this field must return a value of 000b when read.</p> <p>For functions that support PME# from D3_{cold} and do not implement the Data register, the bit assignments corresponding to the maximum current required for $V_{aux(3V3)}$ are:</p> <p>111b — 375 mA 110b — 320 mA 101b — 270 mA 100b — 220 mA 011b — 160 mA 010b — 100 mA 001b — 55 mA 000b — 0 (self powered).</p>
5	DSI	<p>Device Specific Initialization: This bit indicates whether special initialization of this function is required, beyond the standard PCI configuration header, before the generic class device driver is able to use it.</p> <p>This bit is not used by some operating systems. For example, Microsoft Windows and Windows NT do not use this bit to determine whether to use D3. Instead, it is determined using the capabilities of the driver.</p> <p>Logic 1 indicates that the function requires a device-specific initialization sequence, following transition to D0 un-initialized state.</p>
4	reserved	-
3	PMI	<p>PME Clock:</p> <p>0 — Indicates that no PCI clock is required for the function to generate PME#.</p> <p>1 — Indicates that the function relies on the presence of the PCI clock for the PME# operation.</p> <p>Functions that do not support the PME# generation in any state must return logic 0 for this field.</p>
2 to 0	VER[2:0]	<p>Version: A value of 010b indicates that this function complies with <i>PCI Power Management Interface Specification Rev. 1.1</i>.</p>

The logic level of the AMB4 pin at power-on determines the default value of the PMC registers. If this pin is pulled up to 3.3 V, the ISP1563 will report that it supports PME generation in D3_{cold} (bit 15 (PME_S4) will be set to 1). If this pin is left open or is pulled down, the ISP1563 will report that it does not support PME generation in D3_{cold} (bit 15 (PME_S4) will be reset to 0).

8.2.3.4 PMCSR register

The Power Management Control/Status (PMCSR) register is a 2 B register used to manage the Power Management State of the PCI function, as well as to allow and monitor Power Management Events (PMEs). The bit allocation of the register is given in [Table 35](#).

Table 35: PMCSR - Power Management Control/Status register bit allocation

Address: Value read from address 34h + 4h

Bit	15	14	13	12	11	10	9	8
Symbol	PMES	DS[1:0]		D_S[3:0]				PMEE
Reset	X ^[1]	0	0	0	0	0	0	X ^[1]
Access	R/W	R	R	R/W	R/W	R/W	R/W	R/W
Bit	7	6	5	4	3	2	1	0
Symbol	reserved ^[2]						PS[1:0]	
Reset	0	0	0	0	0	0	0	0
Access	R/W	R/W	R/W	R/W	R/W	R/W	R/W	R/W

[1] Sticky bit, if the function supports PME# from D3_{cold}, then X is indeterminate at the time of initial operating system boot; X is 0 if the function does not support PME# from D3_{cold}.

[2] The reserved bits should always be written with the reset value.

Table 36: PMCSR - Power Management Control/Status register bit description

Address: Value read from address 34h + 4h

Bit	Symbol	Description
15	PMES	PME Status: This bit is set when the function normally assert the PME# signal independent of the state of the PMEE bit. Writing logic 1 to this bit clears it and causes the function to stop asserting PME#, if enabled. Writing logic 0 has no effect. This bit defaults to logic 0, if the function does not support the PME# generation from D3 _{cold} . If the function supports the PME# generation from D3 _{cold} , then this bit is sticky and must be explicitly cleared by the operating system each time the operating system is initially loaded.
14 to 13	DS[1:0]	Data Scale: This two-bit read-only field indicates the scaling factor when interpreting the value of the Data register. The value and meaning of this field vary, depending on which data value is selected by the D_S field. This field is a required component of the Data register (offset 7) and must be implemented, if the Data register is implemented. If the Data register is not implemented, this field must return 00b when PMCSR is read.
12 to 9	D_S[3:0]	Data Select: This four-bit field selects the data that is reported through the Data register and the D_S field. This field is a required component of the Data register (offset 7) and must be implemented, if the Data register is implemented. If the Data register is not implemented, this field must return 00b when PMCSR is read.

Table 36: PMCSR - Power Management Control/Status register bit description...continued
 Address: Value read from address 34h + 4h

Bit	Symbol	Description
8	PMEE	PME Enabled: Logic 1 allows the function to assert PME#. When it is logic 0, PME# assertion is disabled. This bit defaults to logic 0, if the function does not support the PME# generation from D3 _{cold} . If the function supports PME# from D3 _{cold} , then this bit is sticky and must be explicitly cleared by the operating system each time the operating system is initially loaded.
7 to 2	reserved	-
1 to 0	PS[1:0]	Power State: This two-bit field is used to determine the current power state of the EHCI function and to set the function into a new power state. The definition of the field values is given as: 00b — D0 01b — D1 10b — D2 11b — D3 _{hot} . If the software attempts to write an unsupported, optional state to this field, the write operation must complete normally on the bus; however, the data is discarded and no status change occurs.

8.2.3.5 PMCSR_BSE register

The PMCSR PCI-to-PCI Bridge Support Extensions (PMCSR_BSE) register supports PCI bridge-specific functionality and is required for all PCI-to-PCI bridges. The bit allocation of this register is given in [Table 37](#).

Table 37: PMCSR_BSE - PMCSR PCI-to-PCI Bridge Support Extensions register bit allocation

Address: Value read from address 34h + 6h

Bit	7	6	5	4	3	2	1	0
Symbol	BPCC_EN	B2_B3#	reserved					
Reset	0	0	0	0	0	0	0	0
Access	R	R	R	R	R	R	R	R

Table 38: PMCSR_BSE - PMCSR PCI-to-PCI Bridge Support Extensions register bit description

Address: Value read from address 34h + 6h

Bit	Symbol	Description
7	BPCC_EN	<p>Bus Power/Clock Control Enable:</p> <p>1 — Indicates that the bus power or clock control mechanism as defined in Table 39 is enabled.</p> <p>0 — Indicates that the bus or power control policies as defined in Table 39 are disabled.</p> <p>When the Bus Power or Clock Control mechanism is disabled, the bridge's PMCSR Power State (PS) field cannot be used by the system software to control the power or clock of the bridge's secondary bus.</p>
6	B2_B3#	<p>B2/B3 support for D3_{hot}: The state of this bit determines the action that is to occur as a direct result of programming the function to D3_{hot}.</p> <p>1 — Indicates that when the bridge function is programmed to D3_{hot}, its secondary bus's PCI clock will be stopped (B2).</p> <p>0 — Indicates that when the bridge function is programmed to D3_{hot}, its secondary bus will have its power removed (B3).</p> <p>This bit is only meaningful if bit 7 (BPCC_EN) is logic 1.</p>
5 to 0	reserved	-

Table 39: PCI bus power and clock control

Originating device's bridge PM state ^[1]	Secondary bus PM state ^[1]	Resultant actions by bridge (either direct or indirect)
D0	B0	none
D1	B1	none
D2	B2	clock stopped on secondary bus
D3 _{hot}	B2, B3	clock stopped and PCI V _{CC} removed from secondary bus (B3 only); for definition of B2_B3#, see Table 38 .
D3 _{cold}	B3	none

[1] PM: Power Management.

8.2.3.6 Data register

The Data register is an optional, 1 B register that provides a mechanism for the function to report state dependent operating data, such as power consumed or heat dissipated.

[Table 40](#) shows the bit description of the register.

Table 40: Data register bit description

Address: Value read from address 34h + 7h

Legend: * reset value

Bit	Symbol	Access	Value	Description
7 to 0	DATA[7:0]	R	00h*	<p>DATA: This register is used to report the state dependent data requested by the D_S field of the PMCSR register. The value of this register is scaled by the value reported by the DS field of the PMCSR register.</p>

9. I²C-bus interface

A simple I²C-bus interface is provided in the ISP1563 to read customized vendor ID, product ID and some other configuration bits from an external EEPROM.

The I²C-bus interface is for bidirectional communication between ICs using two serial bus wires: SDA (data) and SCL (clock). Both lines are driven by open-drain circuits and must be connected to the positive supply voltage through pull-up resistors, when in use; otherwise, they must be connected to ground.

9.1 Protocol

The I²C-bus protocol defines the following conditions:

- **Bus free:** both SDA and SCL are HIGH
- **START:** a HIGH-to-LOW transition on SDA, while SCL is HIGH
- **STOP:** a LOW-to-HIGH transition on SDA, while SCL is HIGH
- **Data valid:** after a START condition, data on SDA is stable during the HIGH period of SCL; data on SDA may only change while SCL is LOW.

Each device on the I²C-bus has a unique slave address, which the master uses to select a device for access.

The master starts a data transfer using a START condition and ends it by generating a STOP condition. Transfers can only be initiated when the bus is free. The receiver must acknowledge each byte by using a LOW level on SDA during the ninth clock pulse on SCL.

For detailed information, refer to *The I²C-bus Specification, Version 2.1*.

9.2 Hardware connections

The ISP1563 can be connected to an external EEPROM through the I²C-bus interface. The hardware connections are shown in [Figure 5](#).

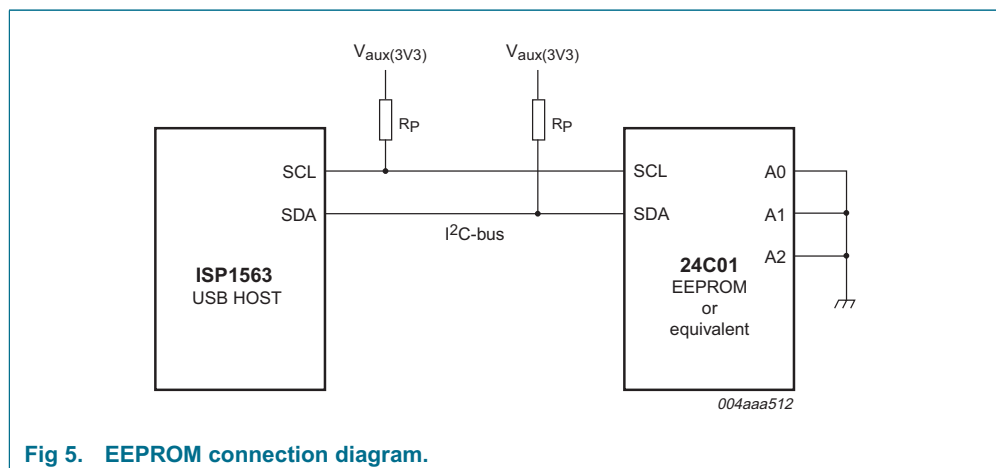
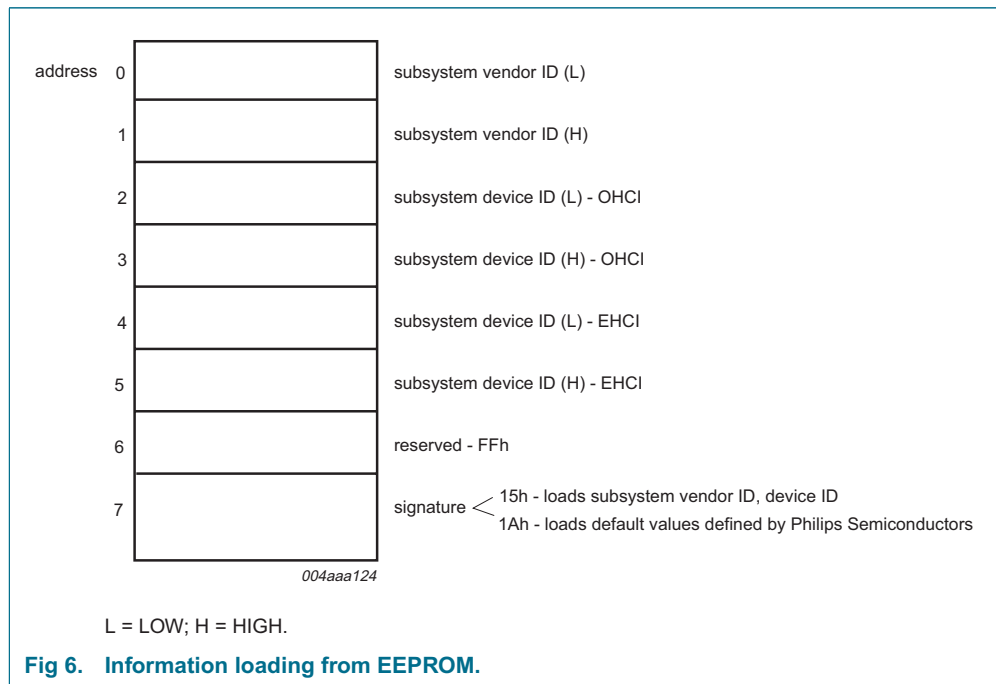

Fig 5. EEPROM connection diagram.

The slave address that the ISP1563 uses to access the EEPROM is 1010000b. Page mode addressing is not supported. Therefore, pins A0, A1 and A2 of the EEPROM must be connected to ground (logic 0).

9.3 Information loading from EEPROM

Figure 6 shows the content of the EEPROM memory. If the EEPROM is not present, the default values of Device ID, Vendor ID, subsystem VID and subsystem DID assigned to Philips Semiconductors by PCI-SIG will be loaded. For default values, see Table 3.



10. Power management

10.1 PCI bus power states

The PCI bus can be characterized by one of the four Power Management States: B0, B1, B2 and B3.

B0 state (PCI clock = 33 MHz, PCI bus power = on) — This corresponds to the bus being fully operational.

B1 state (PCI clock = intermittent clock operation mode, PCI bus power = on) — When a PCI bus is in B1, PCI V_{CC} is still applied to all devices on the bus. No bus transactions, however, are allowed to take place on the bus. The B1 state indicates a perpetual idle state on the PCI bus.

B2 state (PCI clock = stop, PCI bus power = on) — PCI V_{CC} is still applied on the bus, but the clock is stopped and held in the LOW state.

B3 state (PCI clock = stop, PCI bus power = off) — PCI V_{CC} is removed from all devices on the PCI bus segment.



10.2 USB bus states

Reset state — When the USB bus is in the reset state, the USB system is stopped.

Operational state — When the USB bus is in the active state, the USB system is operating normally.

Suspend state — When the USB bus is in the suspend state, the USB system is stopped.

Resume state — When the USB bus is in the resume state, the USB system is operating normally.

11. USB Host Controller registers

Each Host Controller contains a set of on-chip operational registers that are mapped to un-cached memory of the system addressable space. This memory space must begin on a DWord (32-bit) boundary. The size of the allocated space is defined by the initial value in the Base Address register 0. HCDs must interact with these registers to implement USB and legacy support functionality.

After the PCI enumeration driver finishes the PCI device configuration, the new base address of these memory-mapped operational registers is defined in BAR 0. The HCD can access these registers by using the address of base address value + offset.

[Table 41](#) contains a list of Host Controller registers.

Table 41: USB Host Controller registers

Address [1]	OHCI register	Reset value [2]			EHCI register	Reset value [2]	
		Func0 OHCI1 (2P)	Func1 OHCI2 (2P)	Func1 OHCI2 (1P)		Func2 EHCI (4P)	Func2 EHCI (2P)
00h	HcRevision	0000 0110h	0000 0010h	0000 0010h	CAPLENGTH/HCVERSION	0100 0020h	0100 0020h
04h	HcControl	0000 0000h	0000 0000h	0000 0000h	HCSPARAMS	000X 000X 2294h [3]	000X 000X 2192h [3]
08h	HcCommandStatus	0000 0000h	0000 0000h	0000 0000h	HCCPARAMS	0000 0012h	0000 0012h
0Ch	HcInterruptStatus	0000 0000h	0000 0000h	0000 0000h	HCSP-PORTROUTE1[31:0]	0000 1010h	0000 0010h
10h	HcInterruptEnable	0000 0000h	0000 0000h	0000 0000h	HCSP-PORTROUTE2[59:32]	0000 0000h	0000 0000h
14h	HcInterruptDisable	0000 0000h	0000 0000h	0000 0000h	reserved	-	-
18h	HcHCCA	0000 0000h	0000 0000h	0000 0000h	reserved	-	-
1Ch	HcPeriodCurrentED	0000 0000h	0000 0000h	0000 0000h	reserved	-	-
20h	HcControlHeadED	0000 0000h	0000 0000h	0000 0000h	USBCMD	0008 0000h	0008 0000h
24h	HcControlCurrentED	0000 0000h	0000 0000h	0000 0000h	USBSTS	0000 1000h	0000 1000h
28h	HcBulkHeadED	0000 0000h	0000 0000h	0000 0000h	USBINTR	0000 0000h	0000 0000h
2Ch	HcBulkCurrentED	0000 0000h	0000 0000h	0000 0000h	FRINDEX	0000 0000h	0000 0000h
30h	HcDoneHead	0000 0000h	0000 0000h	0000 0000h	reserved	-	-
34h	HcFmInterval	0000 2EDFh	0000 2EDFh	0000 2EDFh	PERIODICLISTBASE	0000 0000h	0000 0000h
38h	HcFmRemaining	0000 0000h	0000 0000h	0000 0000h	ASYNCLISTADDR	0000 0000h	0000 0000h
3Ch	HcFmNumber	0000 0000h	0000 0000h	0000 0000h	reserved	-	-
40h	HcPeriodicStart	0000 0000h	0000 0000h	0000 0000h	reserved	-	-
44h	HcLSThreshold	0000 0628h	0000 0628h	0000 0628h	reserved	-	-
48h	HcRhDescriptorA	FF00 0902h	FF00 0902h	FF00 0901h	reserved	-	-
4Ch	HcRhDescriptorB	0006 0000h	0002 0000h	0002 0000h	reserved	-	-
50h	HcRhStatus	0000 0000h	0000 0000h	0000 0000h	reserved	-	-
54h	HcRhPortStatus[1]	0000 0000h	0000 0000h	0000 0000h	reserved	-	-
58h	HcRhPortStatus[2]	0000 0000h	-	0000 0000h	reserved	-	-
5Ch	reserved	-	-	-	reserved	-	-
60h	reserved	-	-	-	CONFIGFLAG	0000 0000h	0000 0000h
64h	reserved	-	-	-	PORTSC1	0000 2000h	0000 2000h
68h	reserved	-	-	-	PORTSC2	0000 2000h	0000 2000h
6Ch	reserved	-	-	-	PORTSC3	0000 2000h	-

9397 750 14224

© Koninklijke Philips Electronics N.V. 2005. All rights reserved.

Table 41: USB Host Controller registers... continued

Address [1]	OHCI register	Reset value [2]				EHCI register		Reset value [2]	
		Func0 OHCI1 (2P)	Func0 OHCI1 (1P)	Func1 OHCI2 (2P)	Func1 OHCI2 (1P)	Func2 EHCI (4P)	Func2 EHCI (2P)		
70h	reserved	-	-	-	-	PORTSC4	0000 2000h	-	
100h	HceControl	0000 0000h	0000 0000h	0000 0000h	0000 0000h	-	-	-	
104h	HceInput	0000 0000h	0000 0000h	0000 0000h	0000 0000h	-	-	-	
108h	HceOutput	0000 0000h	0000 0000h	0000 0000h	0000 0000h	-	-	-	
10Ch	HceStatus	0000 0000h	0000 0000h	0000 0000h	0000 0000h	-	-	-	

[1] The number of downstream ports, 2 or 4, is configured using pin SEL2PORTS.

[2] Reset values that are highlighted, for example, 0, are the ISP1563 implementation-specific reset values; and reset values that are not highlighted, for example, 0, are compliant with OHCI and EHCI specifications.

[3] See Section 11.1.2.

For the OHCI Host Controller, these registers are divided into two types: one set of operational registers for the USB operation and one set of legacy support registers for the legacy keyboard and mouse operation.

For the Enhanced Host Controller, there are two types of registers: one set of read-only capability registers and one set of read and write operational registers.

11.1 OHCI USB Host Controller operational registers

OHCI HCDs need to communicate with these registers to implement USB data transfers. Based on their functions, these registers are classified into four partitions:

- Control and Status
- Memory Pointer
- Frame Counter
- Root Hub.

11.1.1 HcRevision register

Table 42: HcRevision - Host Controller Revision register bit allocation

Address: Value read from func0 or func1 of address 10h + 00h

Bit	31	30	29	28	27	26	25	24
Symbol	reserved							
Reset	0	0	0	0	0	0	0	0
Access	R	R	R	R	R	R	R	R
Bit	23	22	21	20	19	18	17	16
Symbol	reserved							
Reset	0	0	0	0	0	0	0	0
Access	R	R	R	R	R	R	R	R
Bit	15	14	13	12	11	10	9	8
Symbol	reserved							L
Reset	0	0	0	0	0	0	0	X [1]
Access	R	R	R	R	R	R	R	R
Bit	7	6	5	4	3	2	1	0
Symbol	REV[7:0]							
Reset	0	0	0	1	0	0	0	0
Access	R	R	R	R	R	R	R	R

[1] X is 1 for OHCI1 (2P) and OHCI1 (1P); X is 0 for OHCI2 (2P) and OHCI2 (1P).

Table 43: HcRevision - Host Controller Revision register bit description

Address: Value read from func0 or func1 of address 10h + 00h

Bit	Symbol	Description
31 to 9	reserved	-
8	L	Legacy: 0 — Does not support legacy devices 1 — Supports legacy keyboard and mouse.
7 to 0	REV[7:0]	Revision: This read-only field contains the BCD representation of the version of the HCI specification that is implemented by this Host Controller. For example, a value of 11h corresponds to version 1.1. All of the Host Controller implementations that are compliant with this specification must have a value of 10h.

11.1.2 HcControl register

This register defines the operating modes for the Host Controller. All the fields in this register, except for HCFS and RWC, are modified only by the HCD. The bit allocation is given in [Table 44](#).

Table 44: HcControl - Host Controller Control register bit allocation

Address: Value read from func0 or func1 of address 10h + 04h

Bit	31	30	29	28	27	26	25	24
Symbol	reserved ^[1]							
Reset	0	0	0	0	0	0	0	0
Access	R/W	R/W	R/W	R/W	R/W	R/W	R/W	R/W
Bit	23	22	21	20	19	18	17	16
Symbol	reserved ^[1]							
Reset	0	0	0	0	0	0	0	0
Access	R/W	R/W	R/W	R/W	R/W	R/W	R/W	R/W
Bit	15	14	13	12	11	10	9	8
Symbol	reserved ^[1]					RWE	RWC	IR
Reset	0	0	0	0	0	0	0	0
Access	R/W	R/W	R/W	R/W	R/W	R/W	R/W	R/W
Bit	7	6	5	4	3	2	1	0
Symbol	HCFS[1:0]		BLE	CLE	IE	PLE	CBSR[1:0]	
Reset	0	0	0	0	0	0	0	0
Access	R/W	R/W	R/W	R/W	R/W	R/W	R/W	R/W

[1] The reserved bits should always be written with the reset value.

Table 45: HcControl - Host Controller Control register bit description

Address: Value read from func0 or func1 of address 10h + 04h

Bit	Symbol	Description
31 to 11	reserved	-
10	RWE	Remote Wake-up Enable: This bit is used by the HCD to enable or disable the remote wake-up feature on detecting upstream resume signaling. When this bit and RD (bit 3 in the HcInterruptStatus register) are set, a remote wake-up is signaled to the host system. Setting this bit has no impact on the generation of hardware interrupt.
9	RWC	Remote Wake-up Connected: This bit indicates whether the Host Controller supports remote wake-up signaling. If remote wake-up is supported and used by the system, it is the responsibility of the system firmware to set this bit during POST. The Host Controller clears the bit on a hardware reset but does not alter it on a software reset. Remote wake-up signaling of the host system is host-bus-specific and is not described in this specification.
8	IR	Interrupt Routing: This bit determines the routing of interrupts generated by events registered in HcInterruptStatus. If clear, all interrupts are routed to the normal host bus interrupt mechanism. If set, interrupts are routed to the System Management Interrupt. The HCD clears this bit on a hardware reset, but it does not alter this bit on a software reset. The HCD uses this bit as a tag to indicate the ownership of the Host Controller.
7 to 6	HCFS[1:0]	Host Controller Functional State for USB: 00b — USBRESET 01b — USBRESUME 10b — USBOPERATIONAL 11b — USBSUSPEND A transition to USBOPERATIONAL from another state causes SOF generation to begin 1 ms later. The HCD may determine whether the Host Controller has begun sending SOFs by reading SF (bit 2 of HcInterruptStatus). This field may be changed by the Host Controller only when in the USBSUSPEND state. The Host Controller may move from the USBSUSPEND state to the USBRESUME state after detecting the resume signaling from a downstream port. The Host Controller enters USBSUSPEND after a software reset; it enters USBRESET after a hardware reset. The latter also resets the Root Hub and asserts subsequent reset signaling to downstream ports.
5	BLE	Bulk List Enable: This bit is set to enable the processing of the bulk list in the next Frame. If cleared by the HCD, processing of the bulk list does not occur after the next SOF. The Host Controller checks this bit whenever it wants to process the list. When disabled, the HCD may modify the list. If HcBulkCurrentED is pointing to an Endpoint Descriptor (ED) to be removed, the HCD must advance the pointer by updating HcBulkCurrentED before re-enabling processing of the list.

Table 45: HcControl - Host Controller Control register bit description...continued

Address: Value read from func0 or func1 of address 10h + 04h

Bit	Symbol	Description
4	CLE	Control List Enable: This bit is set to enable the processing of the control list in the next frame. If cleared by the HCD, processing of the control list does not occur after the next SOF. The Host Controller must check this bit whenever it wants to process the list. When disabled, the HCD may modify the list. If HcControlCurrentED is pointing to an ED to be removed, the HCD must advance the pointer by updating HcControlCurrentED before re-enabling processing of the list.
3	IE	Isochronous Enable: This bit is used by the HCD to enable or disable processing of isochronous EDs. While processing the periodic list in a frame, the Host Controller checks the status of this bit when it finds an isochronous ED (F = 1). If set (enabled), the Host Controller continues processing the EDs. If cleared (disabled), the Host Controller halts processing of the periodic list (which now contains only isochronous EDs) and begins processing the bulk or control lists. Setting this bit is guaranteed to take effect in the next frame and not the current frame.
2	PLE	Periodic List Enable: This bit is set to enable the processing of the periodic list in the next frame. If cleared by the HCD, processing of the periodic list does not occur after the next SOF. The Host Controller must check this bit before it starts processing the list.
1 to 0	CBSR[1:0]	Control Bulk Service Ratio: This specifies the service ratio of control EDs over bulk EDs. Before processing any of the nonperiodic lists, the Host Controller must compare the ratio specified with its internal count on how many nonempty control EDs are processed, in determining whether to continue serving another control ED or switch to bulk EDs. The internal count must be retained when crossing the frame boundary. After a reset, the HCD is responsible to restore this value. 00b — 1 : 1 01b — 2 : 1 10b — 3 : 1 11b — 4 : 1.

11.1.3 HcCommandStatus register

The HcCommandStatus register is used by the Host Controller to receive commands issued by the HCD. It also reflects the current status of the Host Controller. To the HCD, it appears as a 'write to set' register. The Host Controller must ensure that bits written as logic 1 become set in the register while bits written as logic 0 remain unchanged in the register. The HCD may issue multiple distinct commands to the Host Controller without concern for corrupting previously issued commands. The HCD has normal read access to all bits.

The SOC[1:0] field (bits 17 and 16 in the HcCommandStatus register) indicates the number of frames with which the Host Controller has detected the scheduling overrun error. This occurs when the periodic list does not complete before EOF. When a scheduling overrun error is detected, the Host Controller increments the counter and sets SO (bit 0 in the HcInterruptStatus register).

[Table 46](#) shows the bit allocation of the HcCommandStatus register.

Table 46: HcCommandStatus - Host Controller Command Status register bit allocation

Address: Value read from func0 or func1 of address 10h + 08h

Bit	31	30	29	28	27	26	25	24
Symbol	reserved [1]							
Reset	0	0	0	0	0	0	0	0
Access	R/W	R/W	R/W	R/W	R/W	R/W	R/W	R/W
Bit	23	22	21	20	19	18	17	16
Symbol	reserved [1]						SOC[1:0]	
Reset	0	0	0	0	0	0	0	0
Access	R/W	R/W	R/W	R/W	R/W	R/W	R/W	R/W
Bit	15	14	13	12	11	10	9	8
Symbol	reserved [1]							
Reset	0	0	0	0	0	0	0	0
Access	R/W	R/W	R/W	R/W	R/W	R/W	R/W	R/W
Bit	7	6	5	4	3	2	1	0
Symbol	reserved [1]				OCR	BLF	CLF	HCR
Reset	0	0	0	0	0	0	0	0
Access	R/W	R/W	R/W	R/W	R/W	R/W	R/W	R/W

[1] The reserved bits should always be written with the reset value.

Table 47: HcCommandStatus - Host Controller Command Status register bit description

Address: Value read from func0 or func1 of address 10h + 08h

Bit	Symbol	Description
31 to 18	reserved	-
17 to 16	SOC[1:0]	Scheduling Overrun Count: The bit is incremented on each scheduling overrun error. It is initialized to 00b and wraps around at 11b. It must be incremented when a scheduling overrun is detected, even if SO (bit 0 in HcInterruptStatus) is already set. This is used by the HCD to monitor any persistent scheduling problems.
15 to 4	reserved	-
3	OCR	Ownership Change Request: This bit is set by an OS HCD to request a change of control of the Host Controller. When set, the Host Controller must set OC (bit 30 in HcInterruptStatus). After the changeover, this bit is cleared and remains so until the next request from the OS HCD.

Table 47: HcCommandStatus - Host Controller Command Status register bit description...continued

Bit	Symbol	Description
2	BLF	Bulk List Filled: This bit is used to indicate whether there are any Transfer Descriptors (TDs) on the bulk list. It is set by the HCD whenever it adds a TD to an ED in the bulk list. When the Host Controller begins to process the head of the bulk list, it checks Bulk-Filled (BF). If BLF is logic 0, the Host Controller does not need to process the bulk list. If BLF is logic 1, the Host Controller needs to start processing the bulk list and set BF to logic 0. If the Host Controller finds a TD on the list, then the Host Controller needs to set BLF to logic 1, causing the bulk list processing to continue. If no TD is found on the bulk list, and if the HCD does not set BLF, then BLF is still logic 0 when the Host Controller completes processing the bulk list and the bulk list processing stops.
1	CLF	Control List Filled: This bit is used to indicate whether there are any TDs on the control list. It is set by the HCD whenever it adds a TD to an ED in the control list. When the Host Controller begins to process the head of the control list, it checks CLF. If CLF is logic 0, the Host Controller does not need to process the control list. If Control-Filled (CF) is logic 1, the Host Controller needs to start processing the control list and set CLF to logic 0. If the Host Controller finds a TD on the list, then the Host Controller needs to set CLF to logic 1, causing the control list processing to continue. If no TD is found on the control list, and if the HCD does not set CLF, then CLF is still logic 0 when the Host Controller completes processing the control list and the control list processing stops.
0	HCR	Host Controller Reset: This bit is set by the HCD to initiate a software reset of the Host Controller. Regardless of the functional state of the Host Controller, it moves to the USB SUSPEND state in which most of the operational registers are reset, except those stated otherwise; for example, IR (bit 8) in the HcControl register, and no host bus accesses are allowed. This bit is cleared by the Host Controller on completing the reset operation. The reset operation must be completed within 10 μ s. This bit, when set, should not cause a reset to the Root Hub and no subsequent reset signaling should be asserted to its downstream ports.

11.1.4 HcInterruptStatus register

This is a 4 B register that provides the status of the events that cause hardware interrupts. The bit allocation of the register is given in [Table 48](#). When an event occurs, the Host Controller sets the corresponding bit in this register. When a bit becomes set, a hardware interrupt is generated, if the interrupt is enabled in the HcInterruptEnable register (see [Table 50](#)) and the MIE (Master Interrupt Enable) bit is set. The HCD may clear specific bits in this register by writing logic 1 to the bit positions to be cleared. The HCD may not set any of these bits. The Host Controller does not clear the bit.

Table 48: HcInterruptStatus - Host Controller Interrupt Status register bit allocation

Address: Value read from func0 or func1 of address 10h + 0Ch

Bit	31	30	29	28	27	26	25	24
Symbol	reserved [1]	OC						reserved [1]
Reset	0	0	0	0	0	0	0	0
Access	R/W	R/W	R/W	R/W	R/W	R/W	R/W	R/W

Bit	23	22	21	20	19	18	17	16
Symbol	reserved ^[1]							
Reset	0	0	0	0	0	0	0	0
Access	R/W	R/W	R/W	R/W	R/W	R/W	R/W	R/W
Bit	15	14	13	12	11	10	9	8
Symbol	reserved ^[1]							
Reset	0	0	0	0	0	0	0	0
Access	R/W	R/W	R/W	R/W	R/W	R/W	R/W	R/W
Bit	7	6	5	4	3	2	1	0
Symbol	reserved ^[1]	RHSC	FNO	UE	RD	SF	WDH	SO
Reset	0	0	0	0	0	0	0	0
Access	R/W	R/W	R/W	R/W	R/W	R/W	R/W	R/W

[1] The reserved bits should always be written with the reset value.

Table 49: HcInterruptStatus - Host Controller Interrupt Status register bit description

Address: Value read from func0 or func1 of address 10h + 0Ch

Bit	Symbol	Description
31	reserved	-
30	OC	Ownership Change: This bit is set by the Host Controller when the HCD sets OCR (bit 3) in the HcCommandStatus register. This event, when unmasked, will always immediately generate a System Management Interrupt (SMI). This bit is forced to logic 0 when the SMI# pin is not implemented.
29 to 7	reserved	-
6	RHSC	Root Hub Status Change: This bit is set when the content of HcRhStatus or the content of any of HcRhPortStatus[NumberOfDownstreamPort] has changed.
5	FNO	Frame Number Overflow: This bit is set when the MSB of HcFmNumber (bit 15) changes value, or after HccaFrameNumber is updated.
4	UE	Unrecoverable Error: This bit is set when the Host Controller detects a system error not related to USB. The Host Controller should not proceed with any processing nor signaling before the system error is corrected. The HCD clears this bit after the Host Controller is reset.
3	RD	Resume Detected: This bit is set when the Host Controller detects that a device on the USB is asserting resume signaling. This bit is set by the transition from no resume signaling to resume signaling. This bit is not set when the HCD sets the USBRESUME state.
2	SF	Start-of-Frame: At the start of each frame, this bit is set by the Host Controller and an SOF token is generated at the same time.
1	WDH	Write-back Done Head: This bit is immediately set after the Host Controller has written HcDoneHead to HccaDoneHead. Further, updates of HccaDoneHead occur only after this bit is cleared. The HCD should only clear this bit after it has saved the content of HccaDoneHead.
0	SO	Scheduling Overrun: This bit is set when USB schedules for current frame overruns and after the update of HccaFrameNumber. A scheduling overrun increments the SOC[1:0] field (bits 17 to 16 of HcCommandStatus).

11.1.5 HcInterruptEnable register

Each enable bit in the HcInterruptEnable register corresponds to an associated interrupt bit in the HcInterruptStatus register. The HcInterruptEnable register is used to control which events generate a hardware interrupt. A hardware interrupt is requested on the host bus if the following conditions occur:

- A bit is set in the HcInterruptStatus register.
- The corresponding bit in the HcInterruptEnable register is set.
- The MIE (Master Interrupt Enable) bit is set.

Writing logic 1 to a bit in this register sets the corresponding bit, whereas writing logic 0 to a bit in this register leaves the corresponding bit unchanged. On a read, the current value of this register is returned. The bit allocation is given in [Table 50](#).

Table 50: HcInterruptEnable - Host Controller Interrupt Enable register bit allocation

Address: Value read from func0 or func1 of address 10h + 10h

Bit	31	30	29	28	27	26	25	24
Symbol	MIE	OC	reserved ^[1]					
Reset	0	0	0	0	0	0	0	0
Access	R/W	R/W	R/W	R/W	R/W	R/W	R/W	R/W
Bit	23	22	21	20	19	18	17	16
Symbol	reserved ^[1]							
Reset	0	0	0	0	0	0	0	0
Access	R/W	R/W	R/W	R/W	R/W	R/W	R/W	R/W
Bit	15	14	13	12	11	10	9	8
Symbol	reserved ^[1]							
Reset	0	0	0	0	0	0	0	0
Access	R/W	R/W	R/W	R/W	R/W	R/W	R/W	R/W
Bit	7	6	5	4	3	2	1	0
Symbol	reserved ^[1]	RHSC	FNO	UE	RD	SF	WDH	SO
Reset	0	0	0	0	0	0	0	0
Access	R/W	R/W	R/W	R/W	R/W	R/W	R/W	R/W

[1] The reserved bits should always be written with the reset value.

Table 51: HcInterruptEnable - Host Controller Interrupt Enable register bit description

Address: Value read from func0 or func1 of address 10h + 10h

Bit	Symbol	Description
31	MIE	Master Interrupt Enable: 0 — Ignore 1 — Enables interrupt generation by events specified in other bits of this register.
30	OC	Ownership Change: 0 — Ignore 1 — Enables interrupt generation because of Ownership Change.
29 to 7	reserved	-

Table 51: HcInterruptEnable - Host Controller Interrupt Enable register bit description...continued

Bit	Symbol	Description
6	RHSC	Root Hub Status Change: 0 — Ignore 1 — Enables interrupt generation because of Root Hub Status Change.
5	FNO	Frame Number Overflow: 0 — Ignore 1 — Enables interrupt generation because of Frame Number Overflow.
4	UE	Unrecoverable Error: 0 — Ignore 1 — Enables interrupt generation because of Unrecoverable Error.
3	RD	Resume Detect: 0 — Ignore 1 — Enables interrupt generation because of Resume Detect.
2	SF	Start-of-Frame: 0 — Ignore 1 — Enables interrupt generation because of Start-of-Frame.
1	WDH	Write-back Done Head: 0 — Ignore 1 — Enables interrupt generation because of HcDoneHead Write-back.
0	SO	Scheduling Overrun: 0 — Ignore 1 — Enables interrupt generation because of Scheduling Overrun.

11.1.6 HcInterruptDisable register

Each disable bit in the HcInterruptDisable register corresponds to an associated interrupt bit in the HcInterruptStatus register. The HcInterruptDisable register is coupled with the HcInterruptEnable register. Therefore, writing logic 1 to a bit in this register clears the corresponding bit in the HcInterruptEnable register, whereas writing logic 0 to a bit in this register leaves the corresponding bit in the HcInterruptEnable register unchanged. On a read, the current value of the HcInterruptEnable register is returned.

The register contains 4 B, and the bit allocation is given in [Table 52](#).

Table 52: HcInterruptDisable - Host Controller Interrupt Disable register bit allocation

Address: Value read from func0 or func1 of address 10h + 14h

Bit	31	30	29	28	27	26	25	24
Symbol	MIE	OC	reserved [1]					
Reset	0	0	0	0	0	0	0	0
Access	R/W	R/W	R/W	R/W	R/W	R/W	R/W	R/W
Bit	23	22	21	20	19	18	17	16
Symbol	reserved [1]							
Reset	0	0	0	0	0	0	0	0
Access	R/W	R/W	R/W	R/W	R/W	R/W	R/W	R/W

Bit	15	14	13	12	11	10	9	8
Symbol	reserved ^[1]							
Reset	0	0	0	0	0	0	0	0
Access	R/W	R/W	R/W	R/W	R/W	R/W	R/W	R/W
Bit	7	6	5	4	3	2	1	0
Symbol	reserved ^[1]	RHSC	FNO	UE	RD	SF	WDH	SO
Reset	0	0	0	0	0	0	0	0
Access	R/W	R/W	R/W	R/W	R/W	R/W	R/W	R/W

[1] The reserved bits should always be written with the reset value.

Table 53: HcInterruptDisable - Host Controller Interrupt Disable register bit description

Address: Value read from func0 or func1 of address 10h + 14h

Bit	Symbol	Description
31	MIE	Master Interrupt Enable: 0 — Ignore 1 — Disables interrupt generation because of events specified in other bits of this register. This field is set after a hardware or software reset. Interrupts are disabled.
30	OC	Ownership Change: 0 — Ignore 1 — Disables interrupt generation because of Ownership Change.
29 to 7	reserved	-
6	RHSC	Root Hub Status Change: 0 — Ignore 1 — Disables interrupt generation because of Root Hub Status Change.
5	FNO	Frame Number Overflow: 0 — Ignore 1 — Disables interrupt generation because of Frame Number Overflow.
4	UE	Unrecoverable Error: 0 — Ignore 1 — Disables interrupt generation because of Unrecoverable Error.
3	RD	Resume Detect: 0 — Ignore 1 — Disables interrupt generation because of Resume Detect.
2	SF	Start-of-Frame: 0 — Ignore 1 — Disables interrupt generation because of Start-of-Frame.
1	WDH	Write-back Done Head: 0 — Ignore 1 — Disables interrupt generation because of HcDoneHead Write-back.
0	SO	Scheduling Overrun: 0 — Ignore 1 — Disables interrupt generation because of Scheduling Overrun.

11.1.7 HcHCCA register

The HcHCCA register contains the physical address of the Host Controller Communication Area (HCCA). The bit allocation is given in [Table 54](#). The HCD determines the alignment restrictions by writing all 1s to HcHCCA and reading the content of HcHCCA. The alignment is evaluated by examining the number of zeroes in the lower order bits. The minimum alignment is 256 B; therefore, bits 0 through 7 will always return logic 0 when read. This area is used to hold the control structures and the Interrupt table that are accessed by both the Host Controller and the HCD.

Table 54: HcHCCA - Host Controller Communication Area register bit allocation

Address: Value read from func0 or func1 of address 10h + 18h

Bit	31	30	29	28	27	26	25	24
Symbol	HCCA[23:16]							
Reset	0	0	0	0	0	0	0	0
Access	R/W	R/W	R/W	R/W	R/W	R/W	R/W	R/W
Bit	23	22	21	20	19	18	17	16
Symbol	HCCA[15:8]							
Reset	0	0	0	0	0	0	0	0
Access	R/W	R/W	R/W	R/W	R/W	R/W	R/W	R/W
Bit	15	14	13	12	11	10	9	8
Symbol	HCCA[7:0]							
Reset	0	0	0	0	0	0	0	0
Access	R/W	R/W	R/W	R/W	R/W	R/W	R/W	R/W
Bit	7	6	5	4	3	2	1	0
Symbol	reserved ^[1]							
Reset	0	0	0	0	0	0	0	0
Access	R/W	R/W	R/W	R/W	R/W	R/W	R/W	R/W

[1] The reserved bits should always be written with the reset value.

Table 55: HcHCCA - Host Controller Communication Area register bit description

Address: Value read from func0 or func1 of address 10h + 18h

Bit	Symbol	Description
31 to 8	HCCA[23:0]	Host Controller Communication Area Base Address: This is the base address of the HCCA.
7 to 0	reserved	-

11.1.8 HcPeriodCurrentED register

The HcPeriodCurrentED register contains the physical address of the current isochronous or interrupt ED. [Table 56](#) shows the bit allocation of the register.

Table 56: HcPeriodCurrentED - Host Controller Period Current Endpoint Descriptor register bit allocation

Address: Value read from func0 or func1 of address 10h + 1Ch

Bit	31	30	29	28	27	26	25	24
Symbol	PCED[27:20]							
Reset	0	0	0	0	0	0	0	0
Access	R	R	R	R	R	R	R	R

Bit	23	22	21	20	19	18	17	16
Symbol	PCED[19:12]							
Reset	0	0	0	0	0	0	0	0
Access	R	R	R	R	R	R	R	R
Bit	15	14	13	12	11	10	9	8
Symbol	PCED[11:4]							
Reset	0	0	0	0	0	0	0	0
Access	R	R	R	R	R	R	R	R
Bit	7	6	5	4	3	2	1	0
Symbol	PCED[3:0]				reserved			
Reset	0	0	0	0	0	0	0	0
Access	R	R	R	R	R	R	R	R

Table 57: HcPeriodCurrentED - Host Controller Period Current Endpoint Descriptor register bit description

Address: Value read from func0 or func1 of address 10h + 1Ch

Bit	Symbol	Description
31 to 4	PCED[27:0]	Period Current ED: This is used by the Host Controller to point to the head of one of the periodic lists that must be processed in the current frame. The content of this register is updated by the Host Controller after a periodic ED is processed. The HCD may read the content in determining which ED is being processed at the time of reading.
3 to 0	reserved	-

11.1.9 HcControlHeadED register

The HcControlHeadED register contains the physical address of the first ED of the control list. The bit allocation is given in [Table 58](#).

Table 58: HcControlHeadED - Host Controller Control Head Endpoint Descriptor register bit allocation

Address: Value read from func0 or func1 of address 10h + 20h

Bit	31	30	29	28	27	26	25	24
Symbol	CHED[27:20]							
Reset	0	0	0	0	0	0	0	0
Access	R	R	R	R	R	R	R	R
Bit	23	22	21	20	19	18	17	16
Symbol	CHED[19:12]							
Reset	0	0	0	0	0	0	0	0
Access	R	R	R	R	R	R	R	R
Bit	15	14	13	12	11	10	9	8
Symbol	CHED[11:4]							
Reset	0	0	0	0	0	0	0	0
Access	R	R	R	R	R	R	R	R
Bit	7	6	5	4	3	2	1	0
Symbol	CHED[3:0]				reserved			
Reset	0	0	0	0	0	0	0	0
Access	R	R	R	R	R	R	R	R

Table 59: HcControlHeadED - Host Controller Control Head Endpoint Descriptor register bit description

Address: Value read from func0 or func1 of address 10h + 20h

Bit	Symbol	Description
31 to 4	CHED[27:0]	Control Head ED: The Host Controller traverses the control list, starting with the HcControlHeadED pointer. The content is loaded from HCCA during the initialization of the Host Controller.
3 to 0	reserved	-

11.1.10 HcControlCurrentED register

The HcControlCurrentED register contains the physical address of the current ED of the control list. The bit allocation is given in [Table 60](#).

Table 60: HcControlCurrentED - Host Controller Control Current Endpoint Descriptor register bit allocation

Address: Value read from func0 or func1 of address 10h + 24h

Bit	31	30	29	28	27	26	25	24
Symbol	CCED[27:20]							
Reset	0	0	0	0	0	0	0	0
Access	R	R	R	R	R	R	R	R
Bit	23	22	21	20	19	18	17	16
Symbol	CCED[19:12]							
Reset	0	0	0	0	0	0	0	0
Access	R	R	R	R	R	R	R	R
Bit	15	14	13	12	11	10	9	8
Symbol	CCED[11:4]							
Reset	0	0	0	0	0	0	0	0
Access	R	R	R	R	R	R	R	R
Bit	7	6	5	4	3	2	1	0
Symbol	CCED[3:0]				reserved			
Reset	0	0	0	0	0	0	0	0
Access	R	R	R	R	R	R	R	R

Table 61: HcControlCurrentED - Host Controller Control Current Endpoint Descriptor register bit description

Address: Value read from func0 or func1 of address 10h + 24h

Bit	Symbol	Description
31 to 4	CCED[27:0]	Control Current ED: This pointer is advanced to the next ED after serving the current ED. The Host Controller needs to continue processing the list from where it was left in the last frame. When it reaches the end of the control list, the Host Controller checks CLF (bit 1 of HcCommandStatus). If set, it copies the content of HcControlHeadED to HcControlCurrentED and clears the bit. If not set, it does nothing. The HCD is allowed to modify this register only when CLE (bit 4 of HcControl) is cleared. When set, the HCD only reads the instantaneous value of this register. Initially, this is set to logic 0 to indicate the end of the control list.
3 to 0	reserved	-

11.1.11 HcBulkHeadED register

This is a four-byte register, and the bit allocation is given in [Table 62](#). The register contains the physical address of the first ED of the bulk list.

Table 62: HcBulkHeadED - Host Controller Bulk Head Endpoint Descriptor register bit allocation

Address: Value read from func0 or func1 of address 10h + 28h

Bit	31	30	29	28	27	26	25	24
Symbol	BHED[27:20]							
Reset	0	0	0	0	0	0	0	0
Access	R/W	R/W	R/W	R/W	R/W	R/W	R/W	R/W
Bit	23	22	21	20	19	18	17	16
Symbol	BHED[19:12]							
Reset	0	0	0	0	0	0	0	0
Access	R/W	R/W	R/W	R/W	R/W	R/W	R/W	R/W
Bit	15	14	13	12	11	10	9	8
Symbol	BHED[11:4]							
Reset	0	0	0	0	0	0	0	0
Access	R/W	R/W	R/W	R/W	R/W	R/W	R/W	R/W
Bit	7	6	5	4	3	2	1	0
Symbol	BHED[3:0]				reserved ^[1]			
Reset	0	0	0	0	0	0	0	0
Access	R/W	R/W	R/W	R/W	R/W	R/W	R/W	R/W

[1] The reserved bits should always be written with the reset value.

Table 63: HcBulkHeadED - Host Controller Bulk Head Endpoint Descriptor register bit description

Address: Value read from func0 or func1 of address 10h + 28h

Bit	Symbol	Description
31 to 4	BHED[27:0]	Bulk Head ED: The Host Controller traverses the bulk list starting with the HcBulkHeadED pointer. The content is loaded from HCCA during the initialization of the Host Controller.
3 to 0	reserved	-

11.1.12 HcBulkCurrentED register

This register contains the physical address of the current endpoint of the bulk list. The endpoints are ordered according to their insertion to the list because the bulk list must be served in a round-robin fashion. The bit allocation is given in [Table 64](#).

Table 64: HcBulkCurrentED - Host Controller Bulk Current Endpoint Descriptor register bit allocation

Address: Value read from func0 or func1 of address 10h + 2Ch

Bit	31	30	29	28	27	26	25	24
Symbol	BCED[27:20]							
Reset	0	0	0	0	0	0	0	0
Access	R/W	R/W	R/W	R/W	R/W	R/W	R/W	R/W

Bit	23	22	21	20	19	18	17	16
Symbol	BCED[19:12]							
Reset	0	0	0	0	0	0	0	0
Access	R/W	R/W	R/W	R/W	R/W	R/W	R/W	R/W
Bit	15	14	13	12	11	10	9	8
Symbol	BCED[11:4]							
Reset	0	0	0	0	0	0	0	0
Access	R/W	R/W	R/W	R/W	R/W	R/W	R/W	R/W
Bit	7	6	5	4	3	2	1	0
Symbol	BCED[3:0]				reserved ^[1]			
Reset	0	0	0	0	0	0	0	0
Access	R/W	R/W	R/W	R/W	R/W	R/W	R/W	R/W

[1] The reserved bits should always be written with the reset value.

Table 65: HcBulkCurrentED - Host Controller Bulk Current Endpoint Descriptor register bit description

Address: Value read from func0 or func1 of address 10h + 2Ch

Bit	Symbol	Description
31 to 4	BCED[27:0]	Bulk Current ED: This is advanced to the next ED after the Host Controller has served the current ED. The Host Controller continues processing the list from where it left off in the last frame. When it reaches the end of the bulk list, the Host Controller checks CLF (bit 1 of HcCommandStatus). If the CLF bit is not set, nothing is done. If the CLF bit is set, it copies the content of HcBulkHeadED to HcBulkCurrentED and clears the CLF bit. The HCD can modify this register only when BLE (bit 5 in the HcControl register) is cleared. When HcControl is set, the HCD reads the instantaneous value of this register. This is initially set to logic 0 to indicate the end of the bulk list.
3 to 0	reserved	-

11.1.13 HcDoneHead register

The HcDoneHead register contains the physical address of the last completed TD that was added to the Done queue. In normal operation, the HCD need not read this register because its content is periodically written to the HCCA. [Table 66](#) contains the bit allocation of the register.

Table 66: HcDoneHead - Host Controller Done Head register bit allocation

Address: Value read from func0 or func1 of address 10h + 30h

Bit	31	30	29	28	27	26	25	24
Symbol	DH[27:20]							
Reset	0	0	0	0	0	0	0	0
Access	R/W	R/W	R/W	R/W	R/W	R/W	R/W	R/W
Bit	23	22	21	20	19	18	17	16
Symbol	DH[19:12]							
Reset	0	0	0	0	0	0	0	0
Access	R/W	R/W	R/W	R/W	R/W	R/W	R/W	R/W

Bit	15	14	13	12	11	10	9	8
Symbol	DH[11:4]							
Reset	0	0	0	0	0	0	0	0
Access	R/W	R/W	R/W	R/W	R/W	R/W	R/W	R/W
Bit	7	6	5	4	3	2	1	0
Symbol	DH[3:0]				reserved ^[1]			
Reset	0	0	0	0	0	0	0	0
Access	R/W	R/W	R/W	R/W	R/W	R/W	R/W	R/W

[1] The reserved bits should always be written with the reset value.

Table 67: HcDoneHead - Host Controller Done Head register bit description

Address: Value read from func0 or func1 of address 10h + 30h

Bit	Symbol	Description
31 to 4	DH[27:0]	Done Head: When a TD is completed, the Host Controller writes the content of HcDoneHead to the NextTD field of the TD. The Host Controller then overwrites the content of HcDoneHead with the address of this TD. This is set to logic 0 whenever the Host Controller writes the content of this register to HCCA.
3 to 0	reserved	-

11.1.14 HcFmInterval register

This register contains a 14-bit value that indicates the bit time interval in a frame, that is, between two consecutive SOFs, and a 15-bit value indicating the full-speed maximum packet size that the Host Controller may transmit or receive, without causing a scheduling overrun. The HCD may carry out minor adjustment on FI (Frame Interval) by writing a new value over the present at each SOF. This provides the possibility for the Host Controller to synchronize with an external clocking resource and to adjust any unknown local clock offset. The bit allocation of the register is given in [Table 68](#).

Table 68: HcFmInterval - Host Controller Frame Interval register bit allocation

Address: Value read from func0 or func1 of address 10h + 34h

Bit	31	30	29	28	27	26	25	24
Symbol	FIT	FSMPS[14:8]						
Reset	0	0	0	0	0	0	0	0
Access	R/W	R/W	R/W	R/W	R/W	R/W	R/W	R/W
Bit	23	22	21	20	19	18	17	16
Symbol	FSMPS[7:0]							
Reset	0	0	0	0	0	0	0	0
Access	R/W	R/W	R/W	R/W	R/W	R/W	R/W	R/W
Bit	15	14	13	12	11	10	9	8
Symbol	reserved ^[1]		FI[13:8]					
Reset	0	0	1	0	1	1	1	0
Access	R/W	R/W	R/W	R/W	R/W	R/W	R/W	R/W

Bit	7	6	5	4	3	2	1	0
Symbol	FI[7:0]							
Reset	1	1	0	1	1	1	1	1
Access	R/W	R/W	R/W	R/W	R/W	R/W	R/W	R/W

[1] The reserved bits should always be written with the reset value.

Table 69: HcFmInterval - Host Controller Frame Interval register bit description

Address: Value read from func0 or func1 of address 10h + 34h

Bit	Symbol	Description
31	FIT	Frame Interval Toggle: The HCD toggles this bit whenever it loads a new value to Frame Interval.
30 to 16	FSMPS[14:0]	FS Largest Data Packet: This field specifies the value that is loaded into the largest data packet counter at the beginning of each frame. The counter value represents the largest amount of data in bits that can be sent or received by the Host Controller in a single transaction at any given time, without causing a scheduling overrun. The field value is calculated by the HCD.
15 to 14	reserved	-
13 to 0	FI[13:0]	Frame Interval: This specifies the interval between two consecutive SOFs in bit times. The nominal value is set to 11,999. The HCD should store the current value of this field before resetting the Host Controller to reset this field to its nominal value. The HCD can then restore the stored value on completing the reset sequence.

11.1.15 HcFmRemaining register

The HcFmRemaining register is a 14-bit down counter showing the bit time remaining in the current frame.

Table 70 contains the bit allocation of this 4 B register.

Table 70: HcFmRemaining - Host Controller Frame Remaining register bit allocation

Address: Value read from func0 or func1 of address 10h + 38h

Bit	31	30	29	28	27	26	25	24
Symbol	FRT	reserved [1]						
Reset	0	0	0	0	0	0	0	0
Access	R/W	R/W	R/W	R/W	R/W	R/W	R/W	R/W
Bit	23	22	21	20	19	18	17	16
Symbol	reserved [1]							
Reset	0	0	0	0	0	0	0	0
Access	R/W	R/W	R/W	R/W	R/W	R/W	R/W	R/W
Bit	15	14	13	12	11	10	9	8
Symbol	reserved [1]		FR[13:8]					
Reset	0	0	0	0	0	0	0	0
Access	R/W	R/W	R/W	R/W	R/W	R/W	R/W	R/W

Bit	7	6	5	4	3	2	1	0
Symbol	FR[7:0]							
Reset	0	0	0	0	0	0	0	0
Access	R/W	R/W	R/W	R/W	R/W	R/W	R/W	R/W

[1] The reserved bits should always be written with the reset value.

Table 71: HcFmRemaining - Host Controller Frame Remaining register bit description

Address: Value read from func0 or func1 of address 10h + 38h

Bit	Symbol	Description
31	FRT	Frame Remaining Toggle: This bit is loaded from FIT (bit 31 of HcFmInterval) whenever FR[13:0] reaches 0. This bit is used by the HCD for the synchronization between FI[13:0] (bits 13 to 0 of HcFmInterval) and FR[13:0].
30 to 14	reserved	-
13 to 0	FR[13:0]	Frame Remaining: This counter is decremented at each bit time. When it reaches 0, it is reset by loading the FI[13:0] value specified in HcFmInterval at the next bit time boundary. When entering the USBOPERATIONAL state, the Host Controller reloads the content with FI[13:0] of HcFmInterval and uses the updated value from the next SOF.

11.1.16 HcFmNumber register

This register is a 16-bit counter, and the bit allocation is given in [Table 72](#). It provides a timing reference among events happening in the Host Controller and the HCD. The HCD may use the 16-bit value specified in this register and generate a 32-bit frame number, without requiring frequent access to the register.

Table 72: HcFmNumber - Host Controller Frame Number register bit allocation

Address: Value read from func0 or func1 of address 10h + 3Ch

Bit	31	30	29	28	27	26	25	24
Symbol	reserved ^[1]							
Reset	0	0	0	0	0	0	0	0
Access	R/W	R/W	R/W	R/W	R/W	R/W	R/W	R/W
Bit	23	22	21	20	19	18	17	16
Symbol	reserved ^[1]							
Reset	0	0	0	0	0	0	0	0
Access	R/W	R/W	R/W	R/W	R/W	R/W	R/W	R/W
Bit	15	14	13	12	11	10	9	8
Symbol	reserved ^[1]	FN[13:8]						
Reset	0	0	0	0	0	0	0	0
Access	R/W	R/W	R/W	R/W	R/W	R/W	R/W	R/W
Bit	7	6	5	4	3	2	1	0
Symbol	FN[7:0]							
Reset	0	0	0	0	0	0	0	0
Access	R/W	R/W	R/W	R/W	R/W	R/W	R/W	R/W

[1] The reserved bits should always be written with the reset value.

Table 73: HcFmNumber - Host Controller Frame Number register bit description

Address: Value read from func0 or func1 of address 10h + 3Ch

Bit	Symbol	Description
31 to 14	reserved	-
13 to 0	FN[13:0]	Frame Number: Incremented when HcFmRemaining is reloaded. It must be rolled over to 0h after FFFFh. Automatically incremented when entering the USBOPERATIONAL state. The content is written to HCCA after the Host Controller has incremented Frame Number at each frame boundary and sent an SOF but before the Host Controller reads the first ED in that frame. After writing to HCCA, the Host Controller sets SF (bit 2 of HcInterruptStatus).

11.1.17 HcPeriodicStart register

This register has a 14-bit programmable value that determines when is the earliest time for the Host Controller to start processing the periodic list. For bit allocation, see [Table 74](#).

Table 74: HcPeriodicStart - Host Controller Periodic Start register bit allocation

Address: Value read from func0 or func1 of address 10h + 40h

Bit	31	30	29	28	27	26	25	24
Symbol	reserved ^[1]							
Reset	0	0	0	0	0	0	0	0
Access	R/W	R/W	R/W	R/W	R/W	R/W	R/W	R/W
Bit	23	22	21	20	19	18	17	16
Symbol	reserved ^[1]							
Reset	0	0	0	0	0	0	0	0
Access	R/W	R/W	R/W	R/W	R/W	R/W	R/W	R/W
Bit	15	14	13	12	11	10	9	8
Symbol	reserved ^[1]		P_S[13:8]					
Reset	0	0	0	0	0	0	0	0
Access	R/W	R/W	R/W	R/W	R/W	R/W	R/W	R/W
Bit	7	6	5	4	3	2	1	0
Symbol	P_S[7:0]							
Reset	0	0	0	0	0	0	0	0
Access	R/W	R/W	R/W	R/W	R/W	R/W	R/W	R/W

[1] The reserved bits should always be written with the reset value.

Table 75: HcPeriodicStart - Host Controller Periodic Start register bit description

Address: Value read from func0 or func1 of address 10h + 40h

Bit	Symbol	Description
31 to 14	reserved	-
13 to 0	P_S[13:0]	Periodic_Start: After a hardware reset, this field is cleared. It is then set by the HCD during the Host Controller initialization. The value is roughly calculated as 10 % of HcFmInterval. A typical value is 3E67h. When HcFmRemaining reaches the value specified, processing of the periodic lists have priority over control or bulk processing. The Host Controller, therefore, starts processing the interrupt list after completing the current control or bulk transaction that is in progress.

11.1.18 HcLSThreshold register

This register contains an 11-bit value used by the Host Controller to determine whether to commit to the transfer of a maximum of 8 B low-speed packet before EOF. Neither the Host Controller nor the HCD can change this value. For bit allocation, see [Table 76](#).

Table 76: HcLSThreshold - Host Controller LS Threshold register bit allocation

Address: Value read from func0 or func1 of address 10h + 44h

Bit	31	30	29	28	27	26	25	24
Symbol	reserved [1]							
Reset	0	0	0	0	0	0	0	0
Access	R/W	R/W	R/W	R/W	R/W	R/W	R/W	R/W
Bit	23	22	21	20	19	18	17	16
Symbol	reserved [1]							
Reset	0	0	0	0	0	0	0	0
Access	R/W	R/W	R/W	R/W	R/W	R/W	R/W	R/W
Bit	15	14	13	12	11	10	9	8
Symbol	reserved [1]				LST[11:8]			
Reset	0	0	0	0	0	1	1	0
Access	R/W	R/W	R/W	R/W	R/W	R/W	R/W	R/W
Bit	7	6	5	4	3	2	1	0
Symbol	LST[7:0]							
Reset	0	0	1	0	1	0	0	0
Access	R/W	R/W	R/W	R/W	R/W	R/W	R/W	R/W

[1] The reserved bits should always be written with the reset value.

Table 77: HcLSThreshold - Host Controller LS Threshold register bit description

Address: Value read from func0 or func1 of address 10h + 44h

Bit	Symbol	Description
31 to 12	reserved	-
11 to 0	LST[11:0]	LS Threshold: This field contains a value that is compared to the FR[13:0] field, before initiating a low-speed transaction. The transaction is started only if $FR \geq$ this field. The value is calculated by the HCD, considering the transmission and setup overhead.

11.1.19 HcRhDescriptorA register

This register is the first of two registers describing the characteristics of the Root Hub. Reset values are implementation-specific.

[Table 78](#) shows the bit allocation of the HcRhDescriptorA register.

Table 78: HcRhDescriptorA - Host Controller Root Hub Descriptor A register bit allocation

Address: Value read from func0 or func1 of address 10h + 48h

Bit	31	30	29	28	27	26	25	24
Symbol	POTPGT[7:0]							
Reset	1	1	1	1	1	1	1	1
Access	R/W	R/W	R/W	R/W	R/W	R/W	R/W	R/W

Bit	23	22	21	20	19	18	17	16
Symbol	reserved ^[1]							
Reset	0	0	0	0	0	0	0	0
Access	R/W	R/W	R/W	R/W	R/W	R/W	R/W	R/W
Bit	15	14	13	12	11	10	9	8
Symbol	reserved ^[1]			NOCP	OCPM	DT	NPS	PSM
Reset	0	0	0	0	1	0	0	1
Access	R/W	R/W	R/W	R/W	R/W	R	R/W	R/W
Bit	7	6	5	4	3	2	1	0
Symbol	NDP[7:0]							
Reset	0	0	0	0	0	0	X ^[2]	X ^[3]
Access	R	R	R	R	R	R	R	R

[1] The reserved bits should always be written with the reset value.

[2] X is 1 for OHCI1 (2P) and OHCI2 (2P); X is 0 for OHCI1 (1P) and OHCI2 (1P).

[3] X is 0 for OHCI1 (2P) and OHCI2 (2P); X is 1 for OHCI1 (1P) and OHCI2 (1P).

Table 79: HcRhDescriptorA - Host Controller Root Hub Descriptor A register bit description

Address: Value read from func0 or func1 of address 10h + 48h

Bit	Symbol	Description
31 to 24	POTPGT [7:0]	Power On To Power Good Time: This byte specifies the duration the HCD must wait before accessing a powered-on port of the Root Hub. It is implementation-specific. The unit of time is 2 ms. The duration is calculated as POTPGT × 2 ms.
23 to 13	reserved	-
12	NOCP	No Overcurrent Protection: This bit describes how the overcurrent status for Root Hub ports are reported. When this bit is cleared, the OCPM bit specifies global or per-port reporting. 0 — Overcurrent status is collectively reported for all downstream ports 1 — No overcurrent protection supported.
11	OCPM	Overcurrent Protection Mode: This bit describes how the overcurrent status for Root Hub ports are reported. At reset, this fields reflects the same mode as Power Switching Mode. This field is valid only if the NOCP bit is cleared. 0 — Overcurrent status is collectively reported for all downstream ports 1 — Overcurrent status is reported on a per-port basis.
10	DT	Device Type: This bit specifies that the Root Hub is not a compound device. The Root Hub is not permitted to be a compound device. This field should always read logic 0.

Table 79: HcRhDescriptorA - Host Controller Root Hub Descriptor A register bit description...continued

Address: Value read from func0 or func1 of address 10h + 48h

Bit	Symbol	Description
9	NPS	No Power Switching: This bit is used to specify whether power switching is supported or ports are always powered. It is implementation-specific. When this bit is cleared, the PSM bit specifies global or per-port switching. 0 — Ports are power switched 1 — Ports are always powered on when the Host Controller is powered on.
8	PSM	Power Switching Mode: This bit is used to specify how the power switching of Root Hub ports is controlled. It is implementation-specific. This field is valid only if the NPS bit is cleared. 0 — All ports are powered at the same time. 1 — Each port is individually powered. This mode allows port power to be controlled by either the global switch or per-port switching. If the PPCM (Port Power Control Mask) bit is set, the port responds only to port power commands (Set/Clear Port Power). If the port mask is cleared, then the port is controlled only by the global power switch (Set/Clear Global Power).
7 to 0	NDP[7:0]	Number Downstream Ports: These bits specify the number of downstream ports supported by the Root Hub. It is implementation-specific. The minimum number of ports is 1. The maximum number of ports supported by OHCI is 15.

11.1.20 HcRhDescriptorB register

The HcRhDescriptorB register (see [Table 80](#)) is the second of two registers describing the characteristics of the Root Hub. These fields are written during initialization to correspond to the system implementation. Reset values are implementation-specific.

Table 80: HcRhDescriptorB - Host Controller Root Hub Descriptor B register bit allocation

Address: Value read from func0 or func1 of address 10h + 4Ch

Bit	31	30	29	28	27	26	25	24
Symbol	PPCM[15:0]							
Reset	0	0	0	0	0	0	0	0
Access	R/W	R/W	R/W	R/W	R	R/W	R/W	R/W
Bit	23	22	21	20	19	18	17	16
Symbol	PPCM[7:0]							
Reset	0	0	0	0	0	X ^[1]	1	0
Access	R/W	R/W	R/W	R/W	R/W	R/W	R/W	R/W
Bit	15	14	13	12	11	10	9	8
Symbol	DR[15:8]							
Reset	0	0	0	0	0	0	0	0
Access	R/W	R/W	R/W	R/W	R/W	R/W	R/W	R/W
Bit	7	6	5	4	3	2	1	0
Symbol	DR[7:0]							
Reset	0	0	0	0	0	0	0	0
Access	R/W	R/W	R/W	R/W	R/W	R/W	R/W	R/W

[1] X is 0 for one port, and 1 for two ports.

Table 81: HcRhDescriptorB - Host Controller Root Hub Descriptor B register bit description

Address: Value read from func0 or func1 of address 10h + 4Ch

Bit	Symbol	Description
31 to 16	PPCM[15:0]	Port Power Control Mask: Each bit indicates whether a port is affected by a global power control command when Power Switching Mode is set. When set, only the power state of the port is affected by per-port power control (Set/Clear Port Power). When cleared, the port is controlled by the global power switch (Set/Clear Global Power). If the device is configured to global switching mode (Power Switching Mode = 0), this field is not valid. Bit 0 — reserved Bit 1 — Ganged-power mask on port 1 Bit 2 — Ganged-power mask on port 2.
15 to 0	DR[15:0]	Device Removable: Each bit is dedicated to a port of the Root Hub. When cleared, the attached device is removable. When set, the attached device is not removable. Bit 0 — reserved Bit 1 — Device attached to port 1 Bit 2 — Device attached to port 2.

11.1.21 HcRhStatus register

This register is divided into two parts. The lower word of the DWord represents the Hub Status field, and the upper word represents the Hub Status Change field. Reserved bits should always be written as logic 0. [Table 82](#) contains the bit allocation of the register.

Table 82: HcRhStatus - Host Controller Root Hub Status register bit allocation

Address: Value read from func0 or func1 of address 10h + 50h

Bit	31	30	29	28	27	26	25	24
Symbol	CRWE	reserved ^[1]						
Reset	0	0	0	0	0	0	0	0
Access	R/W	R/W	R/W	R/W	R/W	R/W	R/W	R/W
Bit	23	22	21	20	19	18	17	16
Symbol	reserved ^[1]						CCIC	LPSC
Reset	0	0	0	0	0	0	0	0
Access	R/W	R/W	R/W	R/W	R/W	R/W	R/W	R/W
Bit	15	14	13	12	11	10	9	8
Symbol	DRWE	reserved ^[1]						
Reset	0	0	0	0	0	0	0	0
Access	R/W	R/W	R/W	R/W	R/W	R/W	R/W	R/W
Bit	7	6	5	4	3	2	1	0
Symbol	reserved ^[1]						OCI	LPS
Reset	0	0	0	0	0	0	0	0
Access	R/W	R/W	R/W	R/W	R/W	R/W	R	R/W

[1] The reserved bits should always be written with the reset value.

Table 83: HcRhStatus - Host Controller Root Hub Status register bit description

Address: Value read from func0 or func1 of address 10h + 50h

Bit	Symbol	Description
31	CRWE	On write, Clear Remote Wake-up Enable : 0 — No effect 1 — Clears DRWE (Device Remote Wake-up Enable).
30 to 18	reserved	-
17	CCIC	Overcurrent Indicator Change : This bit is set by hardware when a change has occurred to the OCI bit of this register. 0 — No effect 1 — The HCD clears this bit.
16	LPSC	On read, Local Power Status Change : The Root Hub does not support the local power status feature. Therefore, this bit is always logic 0. On write, Set Global Power : In global power mode (Power Switching Mode = 0), logic 1 is written to this bit to turn on power to all ports (clear Port Power Status). In per-port power mode, it sets Port Power Status only on ports whose Port Power Control Mask bit is not set. Writing logic 0 has no effect.
15	DRWE	On read, Device Remote Wake-up Enable : This bit enables bit Connect Status Change (CSC) as a resume event, causing a state transition from USBUSPEND to USBRESUME and setting the Resume Detected interrupt. 0 — CSC is not a remote wake-up event 1 — CSC is a remote wake-up event. On write, Set Remote Wake-up Enable : Writing logic 1 sets DRWE (Device Remote Wake-up Enable). Writing logic 0 has no effect.
14 to 2	reserved	-
1	OCI	Overcurrent Indicator : This bit reports overcurrent conditions when global reporting is implemented. When set, an overcurrent condition exists. When cleared, all power operations are normal. If the per-port overcurrent protection is implemented, this bit is always logic 0.
0	LPS	On read, Local Power Status : The Root Hub does not support the local power status feature. Therefore, this bit is always read as logic 0. On write, Clear Global Power : In global power mode (Power Switching Mode = 0), logic 1 is written to this bit to turn off power to all ports (clear Port Power Status). In per-port power mode, it clears Port Power Status only on ports whose Port Power Control Mask bit is not set. Writing logic 0 has no effect.

11.1.22 HcRhPortStatus[4:1] register

The HcRhPortStatus[4:1] register is used to control and report port events on a per-port basis. NumberDownstreamPorts represent the number of HcRhPortStatus registers that are implemented in hardware. The lower word reflects the port status. The upper word reflects the status change bits. Some status bits are implemented with special write behavior. If a transaction, token through handshake, is in progress when a write to change port status occurs, the resulting port status change is postponed until the transaction completes. Always write logic 0 to the reserved bits. The bit allocation of the register is given in [Table 84](#).

Table 84: HcRhPortStatus[4:1] - Host Controller Root Hub Port Status[4:1] register bit allocation

Address: Value read from func0 or func1 of address 10h + 54h

Bit	31	30	29	28	27	26	25	24
Symbol	reserved [1]							
Reset	0	0	0	0	0	0	0	0
Access	R/W	R/W	R/W	R/W	R/W	R/W	R/W	R/W
Bit	23	22	21	20	19	18	17	16
Symbol	reserved [1]			PRSC	OCIC	PSSC	PESC	CSC
Reset	0	0	0	0	0	0	0	0
Access	R/W	R/W	R/W	R/W	R/W	R/W	R/W	R/W
Bit	15	14	13	12	11	10	9	8
Symbol	reserved [1]						LSDA	PPS
Reset	0	0	0	0	0	0	0	0
Access	R/W	R/W	R/W	R/W	R/W	R/W	R/W	R/W
Bit	7	6	5	4	3	2	1	0
Symbol	reserved [1]			PRS	POCI	PSS	PES	CCS
Reset	0	0	0	0	0	0	0	0
Access	R/W	R/W	R/W	R/W	R/W	R/W	R/W	R/W

[1] The reserved bits should always be written with the reset value.

Table 85: HcRhPortStatus[4:1] - Host Controller Root Hub Port Status[4:1] register bit description

Address: Value read from func0 or func1 of address 10h + 54h

Bit	Symbol	Description
31 to 21	reserved	-
20	PRSC	Port Reset Status Change: This bit is set at the end of the 10 ms port reset signal. The HCD can write logic 1 to clear this bit. Writing logic 0 has no effect. 0 — Port reset is not complete 1 — Port reset is complete.
19	OCIC	Port Overcurrent Indicator Change: This bit is valid only if overcurrent conditions are reported on a per-port basis. This bit is set when the Root Hub changes the POCI (Port Overcurrent Indicator) bit. The HCD can write logic 1 to clear this bit. Writing logic 0 has no effect. 0 — No change in POCI 1 — POCI has changed.
18	PSSC	Port Suspend Status Change: This bit is set when the resume sequence is completed. This sequence includes the 20 ms resume pulse, LS EOP and 3 ms re-synchronization delay. The HCD can write logic 1 to clear this bit. Writing logic 0 has no effect. This bit is also cleared when Reset Status Change is set. 0 — Resume is not completed 1 — Resume is completed.

Table 85: HcRhPortStatus[4:1] - Host Controller Root Hub Port Status[4:1] register bit description...continued

Address: Value read from func0 or func1 of address 10h + 54h

Bit	Symbol	Description
17	PESC	<p>Port Enable Status Change: This bit is set when hardware events cause the PES (Port Enable Status) bit to be cleared. Changes from the HCD writes do not set this bit. The HCD can write logic 1 to clear this bit. Writing logic 0 has no effect.</p> <p>0 — No change in PES 1 — Change in PES.</p>
16	CSC	<p>Connect Status Change: This bit is set whenever a connect or disconnect event occurs. The HCD can write logic 1 to clear this bit. Writing logic 0 has no effect. If CCS (Current Connect Status) is cleared when a Set Port Reset, Set Port Enable or Set Port Suspend write occurs, this bit is set to force the driver to re-evaluate the connection status because these writes should not occur if the port is disconnected.</p> <p>0 — No change in CCS 1 — Change in CCS.</p> <p>Remark: If the DeviceRemovable[NDP] bit is set, this bit is set only after a Root Hub reset to inform the system that the device is attached.</p>
15 to 10	reserved	-
9	LSDA	<p>On read, Low-Speed Device Attached: This bit indicates the speed of the device attached to this port. When set, a low-speed device is attached to this port. When cleared, a full-speed device is attached to this port. This bit is valid only when CCS is set.</p> <p>0 — Port is not suspended 1 — Port is suspended.</p> <p>On write, Clear Port Power: The HCD can clear the PPS (Port Power Status) bit by writing logic 1 to this bit. Writing logic 0 has no effect.</p>
8	PPS	<p>On read, Port Power Status: This bit reflects the port power status, regardless of the type of power switching implemented. This bit is cleared if an overcurrent condition is detected. The HCD can set this bit by writing Set Port Power or Set Global Power. The HCD can clear this bit by writing Clear Port Power or Clear Global Power. Power Switching Mode and PortPowerControlMask[NDP] determine which power control switches are enabled. In global switching mode (Power Switching Mode = 0), only Set/Clear Global Power controls this bit. In the per-port power switching (Power Switching Mode = 1), if the PortPowerControlMask[NDP] bit for the port is set, only Set/Clear Port Power commands are enabled. If the mask is not set, only Set/Clear Global Power commands are enabled.</p> <p>When port power is disabled, bits CCS (Current Connect Status), PES (Port Enable Status), PSS (Port Suspend Status) and PRS (Port Reset Status) should be reset.</p> <p>0 — Port power is off 1 — Port power is on.</p> <p>On write, Set Port Power: The HCD can write logic 1 to set the PPS bit. Writing logic 0 has no effect.</p> <p>Remark: This bit always reads logic 1 if power switching is not supported.</p>
7 to 5	reserved	-

Table 85: HcRhPortStatus[4:1] - Host Controller Root Hub Port Status[4:1] register bit description...continued*Address: Value read from func0 or func1 of address 10h + 54h*

Bit	Symbol	Description
4	PRS	<p>On read, Port Reset Status: When this bit is set by a write to Set Port Reset, port reset signaling is asserted. When reset is completed and PRSC is set, this bit is cleared.</p> <p>0 — Port reset signal is inactive 1 — Port reset signal is active.</p> <p>On write, Set Port Reset: The HCD can set the port reset signaling by writing logic 1 to this bit. Writing logic 0 has no effect. If CCS is cleared, this write does not set PRS (Port Reset Status) but instead sets CCS. This informs the driver that it attempted to reset a disconnected port.</p>
3	POCI	<p>On read, Port Overcurrent Indicator: This bit is valid only when the Root Hub is configured to show overcurrent conditions are reported on a per-port basis. If the per-port overcurrent reporting is not supported, this bit is set to logic 0. If cleared, all power operations are normal for this port. If set, an overcurrent condition exists on this port.</p> <p>0 — No overcurrent condition 1 — Overcurrent condition detected.</p> <p>On write, Clear Suspend Status: The HCD can write logic 1 to initiate a resume. Writing logic 0 has no effect. A resume is initiated only if PSS (Port Suspend Status) is set.</p>

Table 85: HcRhPortStatus[4:1] - Host Controller Root Hub Port Status[4:1] register bit description...continued

Address: Value read from func0 or func1 of address 10h + 54h

Bit	Symbol	Description
2	PSS	<p>On read, Port Suspend Status: This bit indicates whether the port is suspended or is in the resume sequence. It is set by a Set Suspend State write and cleared when PSSC (Port Suspend Status Change) is set at the end of the resume interval. This bit is not set if CCS (Current Connect Status) is cleared. This bit is also cleared when PRSC is set at the end of the port reset or when the Host Controller is placed in the USBRESUME state. If an upstream resume is in progress, it will propagate to the Host Controller.</p> <p>0 — Port is not suspended 1 — Port is suspended.</p> <p>On write, Set Port Suspend: The HCD can set the PSS (Port Suspend Status) bit by writing logic 1 to this bit. Writing logic 0 has no effect. If CCS is cleared, this write does not set PSS; instead it sets CSS. This informs the driver that it attempted to suspend a disconnected port.</p>
1	PES	<p>On read, Port Enable Status: This bit indicates whether the port is enabled or disabled. The Root Hub may clear this bit when an overcurrent condition, disconnect event, switched-off power or operational bus error is detected. This change also causes Port Enabled Status Change to be set. The HCD can set this bit by writing Set Port Enable and clear it by writing Clear Port Enable. This bit cannot be set when CCS (Current Connect Status) is cleared. This bit is also set on completing a port reset when Reset Status Change is set or on completing a port suspend when Suspend Status Change is set.</p> <p>0 — Port is disabled 1 — Port is enabled.</p> <p>On write, Set Port Enable: The HCD can set PES (Port Enable Status) by writing logic 1. Writing logic 0 has no effect. If CCS is cleared, this write does not set PES, but instead sets CSC (Connect Status Change). This informs the driver that it attempted to enable a disconnected port.</p>
0	CCS	<p>On read, Current Connect Status: This bit reflects the current state of the downstream port.</p> <p>0 — No device connected 1 — Device connected.</p> <p>On write, Clear Port Enable: The HCD can write logic 1 to this bit to clear the PES (Port Enable Status) bit. Writing logic 0 has no effect. The CCS bit is not affected by any write.</p> <p>Remark: This bit always reads logic 1 when the attached device is nonremovable (DeviceRemovable[NDP]).</p>

11.2 USB legacy support registers

The ISP1563 supports legacy keyboard and mouse. Four operational registers are used to provide the legacy support. Each of these registers is located on a 32-bit boundary. The offset of these registers is relative to the base address of the Host Controller operational registers with HceControl located at offset 100h.

Table 86: Legacy support registers

Offset	Register	Description
100h	HceControl	used to enable and control the emulation hardware and report various status information
104h	HceInput	emulation of the legacy Input Buffer register
108h	HceOutput	emulation of the legacy Output Buffer register in which the software writes keyboard and mouse data
10Ch	HceStatus	emulation of the legacy Status register

Table 87: Emulated registers

I/O address	Cycle type	Register contents accessed or modified	Side effects
60h	IN	HceOutput	IN from port 60h sets OUT_FULL (bit 0) in HceStatus to logic 0
60h	OUT	HceInput	OUT to port 60h sets IN_FULL (bit 1) to logic 1 and CMD_DATA (bit 3) to logic 0 in HceStatus
64h	IN	HceStatus	IN from port 64h returns current value of HceStatus with no other side effect
64h	OUT	HceInput	OUT to port 64h sets IN_FULL to logic 0 and CMD_DATA to logic 1 in HceStatus

11.2.1 HceControl register

Table 88 shows the bit allocation of the register.

Table 88: HceControl - Host Controller Emulation Control register bit allocation

Address: Value read from func0 or func1 of address 10h + 100h

Bit	31	30	29	28	27	26	25	24
Symbol	reserved [1]							
Reset	0	0	0	0	0	0	0	0
Access	R/W	R/W	R/W	R/W	R/W	R/W	R/W	R/W
Bit	23	22	21	20	19	18	17	16
Symbol	reserved [1]							
Reset	0	0	0	0	0	0	0	0
Access	R/W	R/W	R/W	R/W	R/W	R/W	R/W	R/W
Bit	15	14	13	12	11	10	9	8
Symbol	reserved [1]							A20S
Reset	0	0	0	0	0	0	0	0
Access	R/W	R/W	R/W	R/W	R/W	R/W	R/W	R/W

Bit	7	6	5	4	3	2	1	0
Symbol	IRQ12A	IRQ1A	GA20S	EIRQEN	IRQEN	C_P	EI	EE
Reset	0	0	0	0	0	0	0	0
Access	R/W	R/W	R/W	R/W	R/W	R/W	R	R/W

[1] The reserved bits should always be written with the reset value.

Table 89: HceControl - Host Controller Emulation Control register bit description

Address: Value read from func0 or func1 of address 10h + 100h

Bit	Symbol	Description
31 to 9	reserved	-
8	A20S	A20 State: This bit indicates the current state of Gate A20 on the keyboard controller. It is used to compare against value written to 60h when GA20S is active.
7	IRQ12A	IRQ12 Active: This bit indicates that a positive transition on IRQ12 from the keyboard controller has occurred. 0 — No effect 1 — Sets IRQ12 to logic 0 (inactive).
6	IRQ1A	IRQ1 Active: This bit indicates that a positive transition on IRQ1 from the keyboard controller has occurred. 0 — No effect 1 — Sets IRQ11 to logic 0 (inactive).
5	GA20S	Gate A20 Sequence: This bit is set by the Host Controller when a data value of D1h is written to I/O port 64h and cleared on a write to I/O port 64h of any value other than D1h.
4	EIRQEN	External IRQ Enable: When this bit is set to logic 1, IRQ1 and IRQ12 from the keyboard controller cause an emulation interrupt. This bit is independent of the setting of the EE bit in this register.
3	IRQEN	IRQ Enable: When this bit is set, the Host Controller generates IRQ1 or IRQ12 as long as OUT_FULL (bit 0 in HceStatus) is logic 1. If AUX_OUT_FULL (bit 5 in HceStatus) is logic 0, then IRQ1 is generated; if it is logic 1, then IRQ12 is generated.
2	C_P	Character Pending: When this bit is set, an emulation interrupt is generated when OUT_FULL is set to logic 0.
1	EI	Emulation Interrupt: This bit shows the emulation interrupt condition. 0 — Legacy emulation enabled 1 — Legacy emulation disabled.
0	EE	Emulation Enable: When this bit is set to logic 1, the Host Controller is enabled for legacy emulation. The Host Controller decodes accesses to I/O registers 60h and 64h and enables interrupts on IRQ1 or IRQ12, or both. The Host Controller also generates an emulation interrupt at appropriate times to invoke the emulation software.

11.2.2 HceInput register

The HceInput register is a 4 B register, and the bit allocation is given in [Table 90](#). I/O data that is written to ports 60h and 64h is captured in this register, when emulation is enabled. This register may be directly read or written by accessing it in the Host Controller's operational register space. When directly accessed in a memory cycle, reads and writes of this register have no side effects.

Table 90: HcelInput - Host Controller Emulation Input register bit allocation

Address: Value read from func0 or func1 of address 10h + 104h

Bit	31	30	29	28	27	26	25	24
Symbol	reserved [1]							
Reset	0	0	0	0	0	0	0	0
Access	R/W	R/W	R/W	R/W	R/W	R/W	R/W	R/W
Bit	23	22	21	20	19	18	17	16
Symbol	reserved [1]							
Reset	0	0	0	0	0	0	0	0
Access	R/W	R/W	R/W	R/W	R/W	R/W	R/W	R/W
Bit	15	14	13	12	11	10	9	8
Symbol	reserved [1]							
Reset	0	0	0	0	0	0	0	0
Access	R/W	R/W	R/W	R/W	R/W	R/W	R/W	R/W
Bit	7	6	5	4	3	2	1	0
Symbol	IN_DATA[7:0]							
Reset	0	0	0	0	0	0	0	0
Access	R/W	R/W	R/W	R/W	R/W	R/W	R/W	R/W

[1] The reserved bits should always be written with the reset value.

Table 91: HcelInput - Host Controller Emulation Input register bit description

Address: Value read from func0 or func1 of address 10h + 104h

Bit	Symbol	Description
31 to 8	reserved	-
7 to 0	IN_DATA[7:0]	Input Data: This register holds data that is written to I/O ports 60h or 64h.

11.2.3 HceOutput register

Data placed in this register by the emulation software is returned when I/O port 60h is read and emulation is enabled. On a read of this location, OUT_FULL (bit 0 in HceStatus) is set to logic 0. The bit allocation is given in [Table 92](#).

Table 92: HceOutput - Host Controller Emulation Output register bit allocation

Address: Value read from func0 or func1 of address 10h + 108h

Bit	31	30	29	28	27	26	25	24
Symbol	reserved [1]							
Reset	0	0	0	0	0	0	0	0
Access	R/W	R/W	R/W	R/W	R/W	R/W	R/W	R/W
Bit	23	22	21	20	19	18	17	16
Symbol	reserved [1]							
Reset	0	0	0	0	0	0	0	0
Access	R/W	R/W	R/W	R/W	R/W	R/W	R/W	R/W

Bit	15	14	13	12	11	10	9	8
Symbol	reserved ^[1]							
Reset	0	0	0	0	0	0	0	0
Access	R/W	R/W	R/W	R/W	R/W	R/W	R/W	R/W
Bit	7	6	5	4	3	2	1	0
Symbol	OUT_DATA[7:0]							
Reset	0	0	0	0	0	0	0	0
Access	R/W	R/W	R/W	R/W	R/W	R/W	R/W	R/W

[1] The reserved bits should always be written with the reset value.

Table 93: HceOutput - Host Controller Emulation Output register bit description

Address: Value read from func0 or func1 of address 10h + 108h

Bit	Symbol	Description
31 to 8	reserved	-
7 to 0	OUT_DATA[7:0]	Output Data: This register holds the data that is returned when an I/O read of port 60h is requested by application software.

11.2.4 HceStatus register

The contents of the HceStatus register are returned on an I/O read of port 64h when emulation is enabled. Reads from and writes to port 60h and writes to port 64h can cause changes in this register. Emulation software can directly access this register through its memory address in the Host Controller's operational register space. Accessing this register through its memory address produces no side effects. [Table 94](#) shows the bit allocation.

Table 94: HceStatus - Host Controller Emulation Status register bit allocation

Address: Value read from func0 or func1 of address 10h + 10Ch

Bit	31	30	29	28	27	26	25	24
Symbol	reserved ^[1]							
Reset	0	0	0	0	0	0	0	0
Access	R/W	R/W	R/W	R/W	R/W	R/W	R/W	R/W
Bit	23	22	21	20	19	18	17	16
Symbol	reserved ^[1]							
Reset	0	0	0	0	0	0	0	0
Access	R/W	R/W	R/W	R/W	R/W	R/W	R/W	R/W
Bit	15	14	13	12	11	10	9	8
Symbol	reserved ^[1]							
Reset	0	0	0	0	0	0	0	0
Access	R/W	R/W	R/W	R/W	R/W	R/W	R/W	R/W
Bit	7	6	5	4	3	2	1	0
Symbol	PARITY	TIMEOUT	AUX_OUT_FULL	INH_SW	CMD_DATA	FLAG	IN_FULL	OUT_FULL
Reset	0	0	0	0	0	0	0	0
Access	R/W	R/W	R/W	R/W	R/W	R/W	R/W	R/W

[1] The reserved bits should always be written with the reset value.

Table 95: HceStatus - Host Controller Emulation Status register bit description

Address: Value read from func0 or func1 of address 10h + 10Ch

Bit	Symbol	Description
31 to 8	reserved	-
7	PARITY	Parity: This bit indicates parity error on keyboard and mouse data.
6	TIMEOUT	Time-out: This bit indicates a time-out.
5	AUX_OUT_FULL	Auxiliary Output Full: IRQ12 is asserted whenever this bit is set to logic 1, OUT_FULL is set to logic 1, and the IRQEN bit is set.
4	INH_SW	Inhibit Switch: This bit reflects the state of the keyboard inhibit switch. If set, the keyboard is active.
3	CMD_DATA	Cmd Data: The Host Controller sets this bit to logic 0 on an I/O write to port 60h and to logic 1 on an I/O write to port 64h.
2	FLAG	Flag: Nominally used as a system flag by software to indicate a warm or cold boot.
1	IN_FULL	Input Full: Except in the case of a Gate A20 sequence, this bit is set to logic 1 on an I/O write to address 60h or 64h. While this bit is set to logic 1 and emulation is enabled, an emulation interrupt condition exists.
0	OUT_FULL	Output Full: The Host Controller sets this bit to logic 0 on a read of I/O port 60h. If IRQEN is set, AUX_OUT_FULL determines which IRQ is activated. While this bit is logic 0 and C_P in HceControl is set to logic 1, an emulation interrupt condition exists.

11.3 EHCI controller capability registers

Other than the OHCI Host Controller, there are some registers in EHCI that define the capability of EHCI. The address range of these registers is located before the operational registers.

11.3.1 CAPLENGTH/HCVERSION register

The bit allocation of this 4 B register is given in [Table 96](#).

Table 96: CAPLENGTH/HCVERSION - Capability Registers Length/Host Controller Interface Version Number register bit allocation

Address: Value read from func2 of address 10h + 00h

Bit	31	30	29	28	27	26	25	24
Symbol	HCVERSION[15:8]							
Reset	0	0	0	0	0	0	0	1
Access	R	R	R	R	R	R	R	R
Bit	23	22	21	20	19	18	17	16
Symbol	HCVERSION[7:0]							
Reset	0	0	0	0	0	0	0	0
Access	R	R	R	R	R	R	R	R
Bit	15	14	13	12	11	10	9	8
Symbol	reserved							
Reset	0	0	0	0	0	0	0	0
Access	R	R	R	R	R	R	R	R

Bit	7	6	5	4	3	2	1	0
Symbol	CAPLENGTH[7:0]							
Reset	0	0	1	0	0	0	0	0
Access	R	R	R	R	R	R	R	R

Table 97: CAPLENGTH/HCIVERSION - Capability Registers Length/Host Controller Interface Version Number register bit description

Address: Value read from func2 of address 10h + 00h

Bit	Symbol	Description
31 to 16	HCIVERSION[15:0]	Host Controller Interface Version Number: This field contains a BCD encoded version number of the interface to which the Host Controller interface conforms.
15 to 8	reserved	-
7 to 0	CAPLENGTH[7:0]	Capability Register Length: This is used as an offset. It is added to the register base to find the beginning of the operational register space.

11.3.2 HCSPARAMS register

The Host Controller Structural Parameters (HCSPARAMS) register is a set of fields that are structural parameters. The bit allocation is given in [Table 98](#).

Table 98: HCSPARAMS - Host Controller Structural Parameters register bit allocation

Address: Value read from func2 of address 10h + 04h

Bit	31	30	29	28	27	26	25	24
Symbol	reserved							
Reset	0	0	0	0	0	0	0	0
Access	R	R	R	R	R	R	R	R
Bit	23	22	21	20	19	18	17	16
Symbol	DPN[3:0]			reserved			P_INDICATOR	
Reset	0	0	0	0	0	0	0	0
Access	R	R	R	R	R	R	R	R
Bit	15	14	13	12	11	10	9	8
Symbol	N_CC[3:0]				N_PCC[3:0]			
Reset	0	0	1	0	0	0	1	0
Access	R	R	R	R	R	R	R	R
Bit	7	6	5	4	3	2	1	0
Symbol	PRR	reserved		PPC	N_PORTS[3:0]			
Reset	1	0	0	1	0	1	0	0
Access	R	R	R	R	R	R	R	R

Table 99: HCSPARAMS - Host Controller Structural Parameters register bit description

Address: Value read from func2 of address 10h + 04h

Bit	Symbol	Description
31 to 24	reserved	-
23 to 20	DPN[3:0]	Debug Port Number: This field identifies which of the Host Controller ports is the debug port. A nonzero value in this field indicates the presence of a debug port. The value in this register must not be greater than N_PORTS.
19 to 17	reserved	-
16	P_INDICATOR	Port Indicators: This bit indicates whether the ports support port indicator control. When this bit is logic 1, the port status and control registers include a read and writable field to control the state of the port indicator. This bit is set by the AMB3 pin during reset.
15 to 12	N_CC[3:0]	Number of Companion Controller: This field indicates the number of companion controllers associated with this Hi-Speed USB Host Controller. A value of zero in this field indicates there are no companion Host Controllers. Port-ownership hand-off is not supported. Only high-speed devices are supported on the Host Controller root ports. A value larger than zero in this field indicates there are companion Original USB Host Controller(s). Port-ownership hand-offs are supported.
11 to 8	N_PCC[3:0]	Number of Ports per Companion Controller: This field indicates the number of ports supported per companion Host Controller. It is used to indicate the port routing configuration to the system software. For example, if N_PORTS has a value of 6 and N_CC has a value of 2, then N_PCC can have a value of 3. The convention is that the first N_PCC ports are assumed to be routed to companion controller 1, the next N_PCC ports to companion controller 2, and so on. In the previous example, N_PCC could have been 4, in which case the first four are routed to companion controller 1, and the last two are routed to companion controller 2. The number in this field must be consistent with N_PORTS and N_CC.
7	PRR	Port Routing Rules: This field indicates the method used to map ports to the companion controllers. 0 — The first N_PCC ports are routed to the lowest numbered function companion Host Controller, the next N_PCC ports are routed to the next lowest function companion controller, and so on. 1 — The port routing is explicitly enumerated by the first N_PORTS elements of the HCSP-PORTROUTE array.
6 to 5	reserved	-
4	PPC	Port Power Control: This field indicates whether the Host Controller implementation includes port power control. Logic 1 indicates the port has port power switches. Logic 0 indicates the port does not have port power switches. The value of this field affects the functionality of the Port Power field in each port status and control register.
3 to 0	N_PORTS[3:0]	N_Ports: This field specifies the number of physical downstream ports implemented on this Host Controller. The value of this field determines how many port registers are addressable in the operational register space. Valid values are in the range of 1h to Fh. Logic 0 in this field is undefined.

11.3.3 HCCPARAMS register

The Host Controller Capability Parameters (HCCPARAMS) register is a 4 B register, and the bit allocation is given in [Table 100](#).

Table 100: HCCPARAMS - Host Controller Capability Parameters register bit allocation

Address: Value read from func2 of address 10h + 08h

Bit	31	30	29	28	27	26	25	24
Symbol	reserved							
Reset	0	0	0	0	0	0	0	0
Access	R	R	R	R	R	R	R	R
Bit	23	22	21	20	19	18	17	16
Symbol	reserved							
Reset	0	0	0	0	0	0	0	0
Access	R	R	R	R	R	R	R	R
Bit	15	14	13	12	11	10	9	8
Symbol	reserved							
Reset	0	0	0	0	0	0	0	0
Access	R	R	R	R	R	R	R	R
Bit	7	6	5	4	3	2	1	0
Symbol	IST[3:0]			reserved			PFLF	64AC
Reset	0	0	0	1	0	0	1	0
Access	R	R	R	R	R	R	R	R

Table 101: HCCPARAMS - Host Controller Capability Parameters register bit description

Address: Value read from func2 of address 10h + 08h

Bit	Symbol	Description
31 to 8	reserved	-
7 to 4	IST[3:0]	Isochronous Scheduling Threshold: Default = implementation dependent. This field indicates, relative to the current position of the executing Host Controller, where software can reliably update the isochronous schedule. When IST[3] is logic 0, the value of the least significant three bits indicates the number of micro frames a Host Controller can hold a set of isochronous data structures, one or more, before flushing the state. When IST[3] is logic 1, the host software assumes the Host Controller may cache an isochronous data structure for an entire frame.

Table 101: HCCPARAMS - Host Controller Capability Parameters register bit description...continued

Bit	Symbol	Description
3 to 2	reserved	-
1	PFLF	Programmable Frame List Flag: Default = implementation dependent. If this bit is cleared, the system software must use a frame list length of 1024 elements with the Host Controller. The USBCMD register FLS[1:0] (bits 3 and 2) is read-only and should be cleared. If PFLF is set, the system software can specify and use a smaller frame list and configure the host through the FLS bit. The frame list must always be aligned on a 4 kB page boundary to ensure that the frame list is always physically contiguous.
0	64AC	64-bit Addressing Capability: This field contains the addressing range capability. 0 — Data structures using 32-bit address memory pointers 1 — Data structures using 64-bit address memory pointers.

11.3.4 HCSP-PORTROUTE register

The HCSP-PORTROUTE (Companion Port Route Description) register is an optional read-only field that is valid only if PRR (bit 7 in the HCSPARAMS register) is logic 1. Its address is value read from func2 of address 10h + 0Ch.

This field is a 15-element nibble array, and each 4 bits is one array element. Each array location corresponds one-to-one with a physical port provided by the Host Controller. For example, PORTROUTE[0] corresponds to the first PORTSC port, PORTROUTE[1] to the second PORTSC port, and so on. The value of each element indicates to which of the companion Host Controllers this port is routed. Only the first N_PORTS elements have valid information. A value of zero indicates that the port is routed to the lowest numbered function companion Host Controller. A value of one indicates that the port is routed to the next lowest numbered function companion Host Controller, and so on.

11.4 Operational registers of Enhanced USB Host Controller

11.4.1 USBCMD register

The USB Command (USBCMD) register indicates the command to be executed by the serial Host Controller. Writing to this register causes a command to be executed.

[Table 102](#) shows the bit allocation.

Table 102: USBCMD - USB Command register bit allocation

Address: Value read from func2 of address 10h + 20h

Bit	31	30	29	28	27	26	25	24
Symbol	reserved ^[1]							
Reset	0	0	0	0	0	0	0	0
Access	R/W	R/W	R/W	R/W	R/W	R/W	R/W	R/W
Bit	23	22	21	20	19	18	17	16
Symbol	ITC[7:0]							
Reset	0	0	0	0	1	0	0	0
Access	R/W	R/W	R/W	R/W	R/W	R/W	R/W	R/W

Bit	15	14	13	12	11	10	9	8
Symbol	reserved ^[1]							
Reset	0	0	0	0	0	0	0	0
Access	R/W	R/W	R/W	R/W	R/W	R/W	R/W	R/W
Bit	7	6	5	4	3	2	1	0
Symbol	LHCR	IAAD	ASE	PSE	FLS[1:0]		HCRESET	RS
Reset	0	0	0	0	0	0	0	0
Access	R/W	R/W	R/W	R/W	R/W	R/W	R/W	R/W

[1] The reserved bits should always be written with the reset value.

Table 103: USBCMD - USB Command register bit description

Address: Value read from func2 of address 10h + 20h

Bit	Symbol	Description
31 to 24	reserved	-
23 to 16	ITC[7:0]	<p>Interrupt Threshold Control: Default = 08h. This field is used by the system software to select the maximum rate at which the Host Controller will issue interrupts. If software writes an invalid value to this register, the results are undefined. Valid values are:</p> <p>00h — reserved</p> <p>01h — 1 micro frame</p> <p>02h — 2 micro frames</p> <p>04h — 4 micro frames</p> <p>08h — 8 micro frames (equals 1 ms)</p> <p>10h — 16 micro frames (equals 2 ms)</p> <p>20h — 32 micro frames (equals 4 ms)</p> <p>40h — 64 micro frames (equals 8 ms).</p> <p>Software modifications to this field while HCH (bit 12 in the USBSTS register) is zero results in undefined behavior.</p>
15 to 8	reserved	-
7	LHCR	<p>Light Host Controller Reset: This control bit is not required. It allows the driver software to reset the EHCI controller, without affecting the state of the ports or the relationship to the companion Host Controllers. If not implemented, a read of this field will always return zero. If implemented, on read:</p> <p>0 — Indicates that the Light Host Controller Reset has completed and it is ready for the host software to reinitialize the Host Controller</p> <p>1 — Indicates that the Light Host Controller Reset has not yet completed.</p>
6	IAAD	<p>Interrupt on Asynchronous Advance Doorbell: This bit is used as a doorbell by software to notify the Host Controller to issue an interrupt the next time it advances the asynchronous schedule. Software must write logic 1 to this bit to ring the doorbell. When the Host Controller has evicted all appropriate cached schedule states, it sets IAA (bit 5 in the USBSTS register). If IAAE (bit 5 in the USBINTR register) is logic 1, then the Host Controller will assert an interrupt at the next interrupt threshold. The Host Controller sets this bit to logic 1 after it sets IAA. Software should not set this bit when the asynchronous schedule is inactive because this results in an undefined value.</p>

Table 103: USBCMD - USB Command register bit description...continued

Address: Value read from func2 of address 10h + 20h

Bit	Symbol	Description
5	ASE	Asynchronous Schedule Enable: Default = 0. This bit controls whether the Host Controller skips processing the asynchronous schedule. 0 — Do not process the asynchronous schedule 1 — Use the ASYNCLISTADDR register to access the asynchronous schedule.
4	PSE	Periodic Schedule Enable: Default = 0. This bit controls whether the Host Controller skips processing the periodic schedule. 0 — Do not process the periodic schedule 1 — Use the PERIODICLISTBASE register to access the periodic schedule.
3 to 2	FLS[1:0]	Frame List Size: Default = 00b. This field is read and write only if PFLF (bit 1 in the HCCPARAMS register) is set to logic 1. This field specifies the size of the frame list. The size the frame list controls which bits in the Frame Index register should be used for the frame list current index. 00b — 1024 elements (4096 B) 01b — 512 elements (2048 B) 10b — 256 elements (1024 B) for small environments 11b — reserved.
1	HCRESET	Host Controller Reset: This control bit is used by the software to reset the Host Controller. The effects of this on Root Hub registers are similar to a chip hardware reset. Setting this bit causes the Host Controller to reset its internal pipelines, timers, counters, state machines, and so on, to their initial value. Any transaction currently in progress on USB is immediately terminated. A USB reset is not driven on downstream ports. This reset does not affect the PCI Configuration registers. All operational registers, including port registers and port state machines are set to their initial values. Port ownership reverts to the companion Host Controller(s). The software must reinitialize the Host Controller to return it to an operational state. This bit is cleared by the Host Controller when the reset process is complete. Software cannot terminate the reset process early by writing logic 0 to this register. Software should check that bit HCH is logic 0 before setting this bit. Attempting to reset an actively running Host Controller results in undefined behavior.
0	RS	Run/Stop: 1 = Run. 0 = Stop. When set, the Host Controller executes the schedule. The Host Controller continues execution as long as this bit is set. When this bit is cleared, the Host Controller completes the current and active transactions in the USB pipeline, and then halts. Bit HCH indicates when the Host Controller has finished the transaction and has entered the stopped state. Software should check that bit HCH is logic 1 before setting this bit.

11.4.2 USBSTS register

The USB Status (USBSTS) register indicates pending interrupts and various states of the Host Controller. The status resulting from a transaction on the serial bus is not indicated in this register. Software clears the register bits by writing ones to them. The bit allocation is given in [Table 104](#).

Table 104: USBSTS - USB Status register bit allocation

Address: Value read from func2 of address 10h + 24h

Bit	31	30	29	28	27	26	25	24
Symbol	reserved ^[1]							
Reset	0	0	0	0	0	0	0	0
Access	R/W	R/W	R/W	R/W	R/W	R/W	R/W	R/W
Bit	23	22	21	20	19	18	17	16
Symbol	reserved ^[1]							
Reset	0	0	0	0	0	0	0	0
Access	R/W	R/W	R/W	R/W	R/W	R/W	R/W	R/W
Bit	15	14	13	12	11	10	9	8
Symbol	ASS	PSSTAT	RECL	HCH	reserved ^[1]			
Reset	0	0	0	1	0	0	0	0
Access	R	R	R	R	R/W	R/W	R/W	R/W
Bit	7	6	5	4	3	2	1	0
Symbol	reserved ^[1]		IAA	HSE	FLR	PCD	USBERRIN T	USBINT
Reset	0	0	0	0	0	0	0	0
Access	R/W	R/W	R	R/W	R/W	R/W	R/W	R/W

[1] The reserved bits should always be written with the reset value.

Table 105: USBSTS - USB Status register bit description

Address: Value read from func2 of address 10h + 24h

Bit	Symbol	Description
31 to 16	reserved	-
15	ASS	Asynchronous Schedule Status: Default = 0. The bit reports the current real status of the asynchronous schedule. If this bit is logic 0, the status of the asynchronous schedule is disabled. If this bit is logic 1, the status of the asynchronous schedule is enabled. The Host Controller is not required to immediately disable or enable the asynchronous schedule when software changes ASE (bit 5 in the USBCMD register). When this bit and the ASE bit have the same value, the asynchronous schedule is either enabled (1) or disabled (0).
14	PSSTAT	Periodic Schedule Status: Default = 0. This bit reports the current status of the periodic schedule. If this bit is logic 0, the status of the periodic schedule is disabled. If this bit is logic 1, the status of the periodic schedule is enabled. The Host Controller is not required to immediately disable or enable the periodic schedule when software changes PSE (bit 4 in the USBCMD register). When this bit and the PSE bit have the same value, the periodic schedule is either enabled (1) or disabled (0).
13	RECL	Reclamation: Default = 0. This is a read-only status bit that is used to detect an empty asynchronous schedule.
12	HCH	HCHalted: Default = 1. This bit is logic 0 when RS (bit 0 of the USBCMD register) is logic 1. The Host Controller sets this bit to logic 1 after it has stopped executing because the RS bit is set to logic 0, either by software or by the Host Controller hardware. For example, on an internal error.

Table 105: USBSTS - USB Status register bit description...continued

Address: Value read from func2 of address 10h + 24h

Bit	Symbol	Description
11 to 6	reserved	-
5	IAA	Interrupt on Asynchronous Advance: Default = 0. The system software can force the Host Controller to issue an interrupt the next time the Host Controller advances the asynchronous schedule by writing logic 1 to IAA (bit 6 in the USBCMD register). This status bit indicates the assertion of that interrupt source.
4	HSE	Host System Error: The Host Controller sets this bit when a serious error occurs during a host system access, involving the Host Controller module. In a PCI system, conditions that set this bit include PCI parity error, PCI master abort and PCI target abort. When this error occurs, the Host Controller clears RS (bit 0 in the USBCMD register) to prevent further execution of the scheduled TDs.
3	FLR	Frame List Rollover: The Host Controller sets this bit to logic 1 when the frame list index rolls over from its maximum value to zero. The exact value at which the rollover occurs depends on the frame list size. For example, if the frame list size, as programmed in FLS[1:0] (bits 3 and 2 of the USBCMD register), is 1024, the Frame Index register rolls over every time bit 13 of the FRINDEX register toggles. Similarly, if the size is 512, the Host Controller sets this bit to logic 1 every time bit 12 of the FRINDEX register toggles.
2	PCD	Port Change Detect: The Host Controller sets this bit to logic 1 when any port (where PO (bit 13 of PORTSC) is cleared) changes to logic 1, or FPR (bit 6 of PORTSC) changes to logic 1 as a result of a J-K transition detected on a suspended port. This bit is allowed to be maintained in the auxiliary power well. Alternatively, it is also acceptable that on a D3-to-D0 transition of the EHCI Host Controller device, this bit is loaded with the logical OR of all of the PORTSC change bits, including force port resume, overcurrent change, enable or disable change, and connect status change.
1	USBERRINT	USB Error Interrupt: The Host Controller sets this bit when an error condition occurs because of completing a USB transaction. For example, error counter underflow. If the Transfer Descriptor (TD) on which the error interrupt occurred also had its IOC bit set, both this bit and the USBINT bit are set. For details, refer to the <i>Enhanced Host Controller Interface Specification for Universal Serial Bus Rev. 1.0</i> .
0	USBINT	USB Interrupt: The Host Controller sets this bit on completing a USB transaction, which results in the retirement of a TD that had its IOC bit set. The Host Controller also sets this bit when a short packet is detected, that is, the actual number of bytes received was less than the expected number of bytes. For details, refer to the <i>Enhanced Host Controller Interface Specification for Universal Serial Bus Rev. 1.0</i> .

11.4.3 USBINTR register

The USB Interrupt Enable (USBINTR) register enables and disables reporting of the corresponding interrupt to the software. When a bit is set and the corresponding interrupt is active, an interrupt is generated to the host. Interrupt sources that are disabled in this register still appear in the USBSTS to allow the software to poll for events. The USBSTS register bit allocation is given in [Table 106](#).

Table 106: USBINTR - USB Interrupt Enable register bit allocation

Address: Value read from func2 of address 10h + 28h

Bit	31	30	29	28	27	26	25	24
Symbol	reserved [1]							
Reset	0	0	0	0	0	0	0	0
Access	R/W	R/W	R/W	R/W	R/W	R/W	R/W	R/W
Bit	23	22	21	20	19	18	17	16
Symbol	reserved [1]							
Reset	0	0	0	0	0	0	0	0
Access	R/W	R/W	R/W	R/W	R/W	R/W	R/W	R/W
Bit	15	14	13	12	11	10	9	8
Symbol	reserved [1]							
Reset	0	0	0	0	0	0	0	0
Access	R/W	R/W	R/W	R/W	R/W	R/W	R/W	R/W
Bit	7	6	5	4	3	2	1	0
Symbol	reserved [1]		IAAE	HSEE	FLRE	PCIE	USBERR INTE	USBINTE
Reset	0	0	0	0	0	0	0	0
Access	R/W	R/W	R/W	R/W	R/W	R/W	R/W	R/W

[1] The reserved bits should always be written with the reset value.

Table 107: USBINTR - USB Interrupt Enable register bit description

Address: Value read from func2 of address 10h + 28h

Bit	Symbol	Description
31 to 6	reserved	-
5	IAAE	Interrupt on Asynchronous Advance Enable: When this bit and IAA (bit 5 in the USBSTS register) are set, the Host Controller issues an interrupt at the next interrupt threshold. The interrupt is acknowledged by software clearing bit IAA.
4	HSEE	Host System Error Enable: When this bit and HSE (bit 4 in the USBSTS register) are set, the Host Controller issues an interrupt. The interrupt is acknowledged by software clearing bit HSE.
3	FLRE	Frame List Rollover Enable: When this bit and FLR (bit 3 in the USBSTS register) are set, the Host Controller issues an interrupt. The interrupt is acknowledged by software clearing bit FLR.
2	PCIE	Port Change Interrupt Enable: When this bit and PCD (bit 2 in the USBSTS register) are set, the Host Controller issues an interrupt. The interrupt is acknowledged by software clearing bit PCD.
1	USBERRI NTE	USB Error Interrupt Enable: When this bit and USBERRINT (bit 1 in the USBSTS register) are set, the Host Controller issues an interrupt at the next interrupt threshold. The interrupt is acknowledged by software clearing bit USBERRINT.
0	USBINTE	USB Interrupt Enable: When this bit and USBINT (bit 0 in the USBSTS register) are set, the Host Controller issues an interrupt at the next interrupt threshold. The interrupt is acknowledged by software clearing bit USBINT.

11.4.4 FRINDEX register

The Frame Index (FRINDEX) register is used by the Host Controller to index into the periodic frame list. The register updates every 125 μ s; once each micro frame. Bits N to 3 are used to select a particular entry in the periodic frame list during periodic schedule execution. The number of bits used for the index depends on the size of the frame list as set by the system software in FLS[1:0] (bits 3 to 2) of the USBCMD register. This register must be written as a DWord. Byte writes produce undefined results. This register cannot be written unless the Host Controller is in the halted state, as indicated by HCH (bit 12 in the USBSTS register). A write to this register while RS (bit 0 in the USBCMD register) is set produces undefined results. Writes to this register also affect the SOF value. The bit allocation is given in [Table 108](#).

Table 108: FRINDEX - Frame Index register bit allocation

Address: Value read from func2 of address 10h + 2Ch

Bit	31	30	29	28	27	26	25	24
Symbol	reserved ^[1]							
Reset	0	0	0	0	0	0	0	0
Access	R/W	R/W	R/W	R/W	R/W	R/W	R/W	R/W
Bit	23	22	21	20	19	18	17	16
Symbol	reserved ^[1]							
Reset	0	0	0	0	0	0	0	0
Access	R/W	R/W	R/W	R/W	R/W	R/W	R/W	R/W
Bit	15	14	13	12	11	10	9	8
Symbol	reserved ^[1]		FRINDEX[13:8]					
Reset	0	0	0	0	0	0	0	0
Access	R/W	R/W	R/W	R/W	R/W	R/W	R/W	R/W
Bit	7	6	5	4	3	2	1	0
Symbol	FRINDEX[7:0]							
Reset	0	0	0	0	0	0	0	0
Access	R/W	R/W	R/W	R/W	R/W	R/W	R/W	R/W

[1] The reserved bits should always be written with the reset value.

Table 109: FRINDEX - Frame Index register bit description

Address: Value read from func2 of address 10h + 2Ch

Bit	Symbol	Description
31 to 14	reserved	-

Table 109: FRINDEX - Frame Index register bit description...continued

Address: Value read from func2 of address 10h + 2Ch

Bit	Symbol	Description															
13 to 0	FRINDEX [13:0]	<p>Frame Index: Bits in this register are used for the frame number in the SOF packet and as the index into the frame list. The value in this register increments at the end of each time frame. For example, micro frame. The bits used for the frame number in the SOF token are taken from bits 13 to 3 of this register. Bits N to 3 are used for the frame list current index. This means that each location of the frame list is accessed eight times (frames or micro frames) before moving to the next index.</p> <p>The following illustrates values of N based on the value of FLS[1:0] (bits 3 to 2 in the USBCMD register).</p> <table border="1"> <thead> <tr> <th>FLS[1:0]</th> <th>Number elements</th> <th>N</th> </tr> </thead> <tbody> <tr> <td>00b</td> <td>1024</td> <td>12</td> </tr> <tr> <td>01b</td> <td>512</td> <td>11</td> </tr> <tr> <td>10b</td> <td>256</td> <td>10</td> </tr> <tr> <td>11b</td> <td>reserved</td> <td>-</td> </tr> </tbody> </table>	FLS[1:0]	Number elements	N	00b	1024	12	01b	512	11	10b	256	10	11b	reserved	-
FLS[1:0]	Number elements	N															
00b	1024	12															
01b	512	11															
10b	256	10															
11b	reserved	-															

11.4.5 PERIODICLISTBASE register

The Periodic Frame List Base Address (PERIODICLISTBASE) register contains the beginning address of the periodic frame list in the system memory. If the Host Controller is in 64-bit mode, as indicated by logic 1 in 64AC (bit 0 in the HCCSPARAMS register), the most significant 32 bits of every control data structure address comes from the CTRLDSSEGMENT register. The system software loads this register before starting the schedule execution by the Host Controller. The memory structure referenced by this physical memory pointer is assumed as 4 kB aligned. The contents of this register are combined with the FRINDEX register to enable the Host Controller to step through the periodic frame list in sequence.

The bit allocation is given in [Table 110](#).

Table 110: PERIODICLISTBASE - Periodic Frame List Base Address register bit allocation

Address: Value read from func2 of address 10h + 34h

Bit	31	30	29	28	27	26	25	24
Symbol	BA[19:12]							
Reset	0	0	0	0	0	0	0	0
Access	R/W	R/W	R/W	R/W	R/W	R/W	R/W	R/W
Bit	23	22	21	20	19	18	17	16
Symbol	BA[11:4]							
Reset	0	0	0	0	0	0	0	0
Access	R/W	R/W	R/W	R/W	R/W	R/W	R/W	R/W
Bit	15	14	13	12	11	10	9	8
Symbol	BA[3:0]				reserved ^[1]			
Reset	0	0	0	0	0	0	0	0
Access	R/W	R/W	R/W	R/W	R/W	R/W	R/W	R/W

Bit	7	6	5	4	3	2	1	0
Symbol	reserved ^[1]							
Reset	0	0	0	0	0	0	0	0
Access	R/W	R/W	R/W	R/W	R/W	R/W	R/W	R/W

[1] The reserved bits should always be written with the reset value.

Table 111: PERIODICLISTBASE - Periodic Frame List Base Address register bit description

Address: Value read from func2 of address 10h + 34h

Bit	Symbol	Description
31 to 12	BA[19:0]	Base Address: These bits correspond to memory address signals 31 to 12, respectively.
11 to 0	reserved	-

11.4.6 ASYNCLISTADDR register

This 32-bit register contains the address of the next asynchronous queue head to be executed. If the Host Controller is in 64-bit mode, as indicated by logic 1 in 64AC (bit 0 of the HCCPARAMS register), the most significant 32 bits of every control data structure address comes from the CTRLDSSEGMENT register. Bits 4 to 0 of this register always return zeros when read. The memory structure referenced by the physical memory pointer is assumed as 32 B (cache aligned). For bit allocation, see [Table 112](#).

Table 112: ASYNCLISTADDR - Current Asynchronous List Address register bit allocation

Address: Value read from func2 of address 10h + 38h

Bit	31	30	29	28	27	26	25	24
Symbol	LPL[19:12]							
Reset	0	0	0	0	0	0	0	0
Access	R/W	R/W	R/W	R/W	R/W	R/W	R/W	R/W
Bit	23	22	21	20	19	18	17	16
Symbol	LPL[11:4]							
Reset	0	0	0	0	0	0	0	0
Access	R/W	R/W	R/W	R/W	R/W	R/W	R/W	R/W
Bit	15	14	13	12	11	10	9	8
Symbol	LPL[3:0]				reserved ^[1]			
Reset	0	0	0	0	0	0	0	0
Access	R/W	R/W	R/W	R/W	R/W	R/W	R/W	R/W
Bit	7	6	5	4	3	2	1	0
Symbol	reserved ^[1]							
Reset	0	0	0	0	0	0	0	0
Access	R/W	R/W	R/W	R/W	R/W	R/W	R/W	R/W

[1] The reserved bits should always be written with the reset value.

Table 113: ASYNCLISTADDR - Current Asynchronous List Address register bit description

Address: Value read from func2 of address 10h + 38h

Bit	Symbol	Description
31 to 12	LPL[19:0]	Link Pointer List: These bits correspond to memory address signals 31 to 12, respectively. This field may only reference a Queue Head (QH).
11 to 0	reserved	-

11.4.7 CONFIGFLAG register

The bit allocation of the Configure Flag (CONFIGFLAG) register is given in [Table 114](#).**Table 114: CONFIGFLAG - Configure Flag register bit allocation**

Address: Value read from func2 of address 10h + 60h

Bit	31	30	29	28	27	26	25	24
Symbol	reserved ^[1]							
Reset	0	0	0	0	0	0	0	0
Access	R/W	R/W	R/W	R/W	R/W	R/W	R/W	R/W
Bit	23	22	21	20	19	18	17	16
Symbol	reserved ^[1]							
Reset	0	0	0	0	0	0	0	0
Access	R/W	R/W	R/W	R/W	R/W	R/W	R/W	R/W
Bit	15	14	13	12	11	10	9	8
Symbol	reserved ^[1]							
Reset	0	0	0	0	0	0	0	0
Access	R/W	R/W	R/W	R/W	R/W	R/W	R/W	R/W
Bit	7	6	5	4	3	2	1	0
Symbol	reserved ^[1]							CF
Reset	0	0	0	0	0	0	0	0
Access	R/W	R/W	R/W	R/W	R/W	R/W	R/W	R/W

[1] The reserved bits should always be written with the reset value.

Table 115: CONFIGFLAG - Configure Flag register bit description

Address: Value read from func2 of address 10h + 60h

Bit	Symbol	Description
31 to 1	reserved	-
0	CF	Configure Flag: The host software sets this bit as the last action in its process of configuring the Host Controller. This bit controls the default port-routing control logic. 0 — Port routing control logic default-routes each port to an implementation dependent classic Host Controller 1 — Port routing control logic default-routes all ports to this Host Controller.

11.4.8 PORTSC registers 1, 2, 3, 4

The Port Status and Control (PORTSC) register is in the auxiliary power well. It is only reset by hardware when the auxiliary power is initially applied or in response to a Host Controller reset. The initial conditions of a port are:

- No device connected
- Port disabled.

If the port has power control, software cannot change the state of the port until it sets the port power bits. Software must not attempt to change the state of the port until power is stable on the port; maximum delay is 20 ms from the transition. For bit allocation, see [Table 116](#).

Table 116: PORTSC 1, 2, 3, 4 - Port Status and Control, 1, 2, 3, 4 register bit allocation

Address: Value read from func2 of address $10h + 64h + (4 \times \text{Port Number} - 1)$ where Port Number is 1, 2, 3, 4

Bit	31	30	29	28	27	26	25	24
Symbol	reserved ^[1]							
Reset	0	0	0	0	0	0	0	0
Access	R/W	R/W	R/W	R/W	R/W	R/W	R/W	R/W
Bit	23	22	21	20	19	18	17	16
Symbol	reserved ^[1]	WKOC_E	WKDSCNN_T_E	WKCNN_T_E	PTC[3:0]			
Reset	0	0	0	0	0	0	0	0
Access	R/W	R/W	R/W	R/W	R/W	R/W	R/W	R/W
Bit	15	14	13	12	11	10	9	8
Symbol	PIC[1:0]		PO	PP	LS[1:0]		reserved ^[1]	PR
Reset	0	0	1	0	0	0	0	0
Access	R	R	R/W	R/W	R/W	R/W	R/W	R
Bit	7	6	5	4	3	2	1	0
Symbol	SUSP	FPR	OCC	OCA	PEDC	PED	ECSC	ECCS
Reset	0	0	0	0	0	0	0	0
Access	R/W	R/W	R	R	R/W	R/W	R/W	R

[1] The reserved bits should always be written with the reset value.

Table 117: PORTSC 1, 2, 3, 4 - Port Status and Control, 1, 2, 3, 4 register bit description

Address: Value read from func2 of address $10h + 64h + (4 \times \text{Port Number} - 1)$ where Port Number is 1, 2, 3, 4

Bit	Symbol	Description
31 to 23	reserved	-
22	WKOC_E	Wake on Overcurrent Enable: Default = 0. Setting this bit enables the port to be sensitive to overcurrent conditions as wake-up events. ^[1]
21	WKDSCNNT_E	Wake on Disconnect Enable: Default = 0. Setting this bit enables the port to be sensitive to device disconnects as wake-up events. ^[1]
20	WKCNN_T_E	Wake on Connect Enable: Default = 0. Setting this bit enables the port to be sensitive to device connects as wake-up events. ^[1]

Table 117: PORTSC 1, 2, 3, 4 - Port Status and Control, 1, 2, 3, 4 register bit description...continued

Address: Value read from func2 of address $10h + 64h + (4 \times \text{Port Number} - 1)$ where Port Number

Bit	Symbol	Description
19 to 16	PTC[3:0]	<p>Port Test Control: Default = 0000b. When this field is logic 0, the port is not operating in test mode. A nonzero value indicates that it is operating in test mode and test mode is indicated by the value. The encoding of the test mode bits are:</p> <p>0000b — Test mode disabled</p> <p>0001b — Test J_STATE</p> <p>0010b — Test K_STATE</p> <p>0011b — Test SE0_NAK</p> <p>0100b — Test packet</p> <p>0101b — Test FORCE_ENABLE</p> <p>0110b to 1111b — reserved.</p>
15 to 14	PIC[1:0]	<p>Port Indicator Control: Default = 0. Writing to this field has no effect if P_INDICATOR (bit 16) in the HCSPARAMS register is logic 0. If P_INDICATOR is logic 1, then the bit encoding is:</p> <p>00b — Port indicators are off</p> <p>01b — Amber</p> <p>10b — Green</p> <p>11b — Undefined.</p> <p>For a description on how these bits are implemented, refer to <i>Universal Serial Bus Specification Rev. 2.0</i>. [1]</p>
13	PO	<p>Port Owner: Default = 1. This bit unconditionally goes to logic 0 when CF (bit 0) in the CONFIGFLAG register makes logic 0 to logic 1 transition. This bit unconditionally goes to logic 1 when the CF bit is logic 0. The system software uses this field to release ownership of the port to a selected Host Controller, if the attached device is not a high-speed device. Software writes logic 1 to this bit, if the attached device is not a high-speed device. Logic 1 in this bit means that a companion Host Controller owns and controls the port.</p>
12	PP	<p>Port Power: The function of this bit depends on the value of PPC (bit 4) in the HCSPARAMS register.</p> <p>If PPC = 0 and PP = 1 — The Host Controller does not have port power control switches. Always powered.</p> <p>If PPC = 1 and PP = 1 or 0 — The Host Controller has port power control switches. This bit represents the current setting of the switch: logic 0 = off, logic 1 = on. When PP is logic 0, the port is nonfunctional and will not report any status.</p> <p>When an overcurrent condition is detected on a powered port and PPC is logic 1, the PP bit in each affected port may be changed by the Host Controller from logic 1 to logic 0, removing power from the port.</p>

Table 117: PORTSC 1, 2, 3, 4 - Port Status and Control, 1, 2, 3, 4 register bit description...continued

Address: Value read from func2 of address $10h + 64h + (4 \times \text{Port Number} - 1)$ where Port Number

Bit	Symbol	Description
11 to 10	LS[1:0]	<p>Line Status: This field reflects the current logical levels of the DP (bit 11) and DM (bit 10) signal lines. These bits are used to detect low-speed USB devices before the port reset and enable sequence. This field is valid only when the Port Enable bit is logic 0, and the Current Connect Status bit is set to logic 1.</p> <p>00b — SE0: Not a low-speed device, perform EHCI reset</p> <p>01b — K-state: Low-speed device, release ownership of port</p> <p>10b — J-state: Not a low-speed device, perform EHCI reset</p> <p>11b — Undefined: Not a low-speed device, perform EHCI reset.</p> <p>If bit PP is logic 0, this field is undefined.</p>
9	reserved	-
8	PR	<p>Port Reset: Logic 1 means the port is in reset. Logic 0 means the port is not in reset. Default = 0. When software sets this bit from logic 0, the bus reset sequence as defined in <i>Universal Serial Bus Specification Rev. 2.0</i> is started. Software clears this bit to terminate the bus reset sequence. Software must hold this bit at logic 1 until the reset sequence, as specified in <i>Universal Serial Bus Specification Rev. 2.0</i>, is completed.</p> <p>Remark: When software sets this bit, it must also clear the Port Enable bit.</p> <p>Remark: When software clears this bit, there may be a delay before the bit status changes to logic 0 because it will not read logic 0 until the reset is completed. If the port is in high-speed mode after reset is completed, the Host Controller will automatically enable this port; it can set the Port Enable bit. A Host Controller must terminate the reset and stabilize the state of the port within 2 ms of software changing this bit from logic 1 to logic 0. For example, if the port detects that the attached device is high-speed during a reset, then the Host Controller must enable the port within 2 ms of software clearing this bit.</p> <p>HCH (bit 12 in the USBSTS register) must be logic 0 before software attempts to use this bit. The Host Controller may hold Port Reset asserted when the HCH bit is set. [1]</p>
7	SUSP	<p>Suspend: Default = 0. Logic 1 means the port is in the suspend state. Logic 0 means the port is not suspended. The PED (Port Enabled) bit and this bit define the port states as follows:</p> <p>PED = 0 and SUSP = X — Port is disabled</p> <p>PED = 1 and SUSP = 0 — Port is enabled</p> <p>PED = 1 and SUSP = 1 — port is suspended.</p> <p>When in the suspend state, downstream propagation of data is blocked on this port, except for the port reset. If a transaction was in progress when this bit was set, blocking occurs at the end of the current transaction. In the suspend state, the port is sensitive to resume detection. The bit status does not change until the port is suspended and there may be a delay in suspending a port, if there is a transaction currently in progress on the USB. Attempts to clear this bit are ignored by the Host Controller. The Host Controller will unconditionally set this bit to logic 0 when:</p> <ul style="list-style-type: none"> • Software changes the FPR (Force Port Resume) bit to logic 0. • Software changes the PR (Port Reset) bit to logic 1. <p>If the host software sets this bit when the Port Enabled bit is logic 0, the results are undefined. [1]</p>

Table 117: PORTSC 1, 2, 3, 4 - Port Status and Control, 1, 2, 3, 4 register bit description...continued

Address: Value read from func2 of address $10h + 64h + (4 \times \text{Port Number} - 1)$ where Port Number

Bit	Symbol	Description
6	FPR	Force Port Resume: Logic 1 means resume detected or driven on the port. Logic 0 means no resume (K-state) detected or driven on the port. Default = 0. Software sets this bit to drive the resume signaling. The Host Controller sets this bit if a J-to-K transition is detected, while the port is in the suspend state. When this bit changes to logic 1 because a J-to-K transition is detected, PCD (bit 2 in register USBSTS) is also set to logic 1. If software sets this bit to logic 1, the Host Controller must not set bit PCD. When the EHCI controller owns the port, the resume sequence follows the sequence given in <i>Universal Serial Bus Specification Rev. 2.0</i> . The resume signaling (full-speed 'K') is driven on the port as long as this bit remains set. Software must time the resume and clear this bit after the correct amount of time has elapsed. Clearing this bit causes the port to return to high-speed mode, forcing the bus below the port into a high-speed idle. This bit will remain at logic 1, until the port has switched to the high-speed idle. The Host Controller must complete this transition within 2 ms of software clearing this bit. [1]
5	OCC	Overcurrent Change: Default = 0. This bit is set to logic 1 when there is a change in overcurrent active. Software clears this bit by setting this bit to logic 1.
4	OCA	Overcurrent Active: Default = 0. If set to logic 1, this port has an overcurrent condition. If set to logic 0, this port does not have an overcurrent condition. This bit will automatically change from logic 1 to logic 0 when the overcurrent condition is removed.
3	PEDC	Port Enable/Disable Change: Logic 1 means the port enabled or disabled status has changed. Logic 0 means no change. Default = 0. For the root hub, this bit is set only when a port is disabled because of the appropriate conditions existing at the EOF2 point. For definition of port error, refer to Chapter 11 of <i>Universal Serial Bus Specification Rev. 2.0</i> . Software clears this bit by setting it. [1]
2	PED	Port Enabled/Disabled: Logic 1 means enable. Logic 0 means disable. Default = 0. Ports can only be enabled by the Host Controller as a part of the reset and enable sequence. Software cannot enable a port by writing logic 1 to this field. The Host Controller will only set this bit when the reset sequence determines that the attached device is a high-speed device. Ports can be disabled by either a fault condition or by host software. The bit status does not change until the port state has changed. There may be a delay in disabling or enabling a port because of other Host Controller and bus events. When the port is disabled, downstream propagation of data is blocked on this port, except for reset. [1]
1	ECSC	Connect Status Change: Logic 1 means change in ECCS. Logic 0 means no change. Default = 0. This bit indicates a change has occurred in the ECCS of the port. The Host Controller sets this bit for all changes to the port device connect status, even if the system software has not cleared an existing connect status change. For example, the insertion status changes two times before the system software has cleared the changed condition, hub hardware will be setting an already-set bit, that is, the bit will remain set. Software clears this bit by writing logic 1 to it. [1]
0	ECCS	Current Connect Status: Logic 1 indicates a device is present on port. Logic 0 indicates no device is present. Default = 0. This value reflects the current state of the port and may not directly correspond to the event that caused the ECSC bit to be set. [1]

[1] These fields read logic 0, if the PP bit is logic 0.

12. Power consumption

[Table 118](#) shows the power consumption.

Table 118: Power consumption when SEL2PORTS is LOW

Power pins group	Conditions	Typ	Unit
Total current on pins $V_{CC(I/O_AUX)} + V_{I(VAUX3V3)} + V_{DDA_AUX}$ $+ V_{CC(I/O)} + V_{I(VREG3V3)}$ [1]	no device connected to the ISP1563 [2]	57	mA
	one high-speed device connected to the ISP1563	79	mA
	two high-speed devices connected to the ISP1563	97	mA
	three high-speed devices connected to the ISP1563	117	mA
	four high-speed devices connected to the ISP1563	135	mA
Auxiliary current on pins $V_{CC(I/O_AUX)} + V_{I(VAUX3V3)} + V_{DDA_AUX}$	no device connected to the ISP1563 [2]	42	mA
	one high-speed device connected to the ISP1563	64	mA
	two high-speed devices connected to the ISP1563	82	mA
	three high-speed devices connected to the ISP1563	102	mA
	four high-speed devices connected to the ISP1563	120	mA
Current on pins $V_{CC(I/O)} + V_{I(VREG3V3)}$	no device connected to the ISP1563	15	mA
	one high-speed device connected to the ISP1563	15	mA
	two high-speed devices connected to the ISP1563	15	mA
	three high-speed devices connected to the ISP1563	15	mA
	four high-speed devices connected to the ISP1563	15	mA

[1] When the SEL2PORTS pin is HIGH, that is, when only two ports are available, the respective current values for the total power are lower by approximately 10 mA than the respective values when SEL2PORTS is LOW.

[2] When one to four full-speed or low-speed power devices are connected, the power consumption is comparable to the power consumption when no high-speed devices are connected. There is a difference of only about 2 mA.

[Table 119](#) shows the power consumption in S1 and S3 suspend modes.

Table 119: Power consumption: S1 and S3

Power state	Typ	Unit
S1	36	mA
S3	11 [1] [2]	mA

[1] When I²C-bus and legacy support are present.

[2] For details, refer to the ISP1563 errata.

13. Limiting values

Table 120: Limiting values
In accordance with the Absolute Maximum Rating System (IEC 60134).

Symbol	Parameter	Conditions	Min	Max	Unit
$V_{CC(I/O)}$	supply voltage to I/O pins		-0.5	+4.6	V
$V_{I(VREG3V3)}$	supply voltage to internal regulator		-0.5	+4.6	V
$V_{CC(I/O_AUX)}$	auxiliary supply voltage to I/O pins		-0.5	+4.6	V
$V_{I(VAUX3V3)}$	auxiliary supply voltage to internal regulator		-0.5	+4.6	V
V_{DDA_AUX}	auxiliary supply voltage for analog block		-0.5	+4.6	V
I_{lu}	latch-up current	$V_I < 0\text{ V}$ or $V_I > V_{CC(I/O)}$	-	100	mA
V_{esd}	electrostatic discharge voltage	all pins ($I_{LI} < 1\ \mu\text{A}$)	-4	+4	kV
T_{stg}	storage temperature		-40	+125	°C

14. Recommended operating conditions

Table 121: Recommended operating conditions

Symbol	Parameter	Conditions	Min	Typ	Max	Unit
$V_{CC(I/O)}$	supply voltage to I/O pins		3.0	3.3	3.6	V
$V_{I(VREG3V3)}$	supply voltage to internal regulator		3.0	3.3	3.6	V
$V_{CC(I/O_AUX)}$	auxiliary supply voltage to I/O pins		3.0	3.3	3.6	V
$V_{I(VAUX3V3)}$	auxiliary supply voltage to internal regulator		3.0	3.3	3.6	V
V_{DDA_AUX}	auxiliary supply voltage for analog block		3.0	3.3	3.6	V
$V_{I(3V3)}$	input voltage on 3.3 V buffers		0	-	$V_{CC(I/O)} + 0.5\text{ V}$	V
T_{amb}	ambient temperature		-40	-	+85	°C

15. Static characteristics

Table 122: Static characteristics: I²C-bus interface (SDA and SCL)

$V_{CC(I/O)} = 3.0\text{ V to }3.6\text{ V}$; $T_{amb} = -40\text{ }^{\circ}\text{C to }+85\text{ }^{\circ}\text{C}$; unless otherwise specified.

Symbol	Parameter	Conditions	Min	Typ	Max	Unit
V_{IH}	HIGH-level input voltage		2.1	-	-	V
V_{IL}	LOW-level input voltage		-	-	0.9	V
V_{hys}	hysteresis voltage		0.15	-	-	V
V_{OL}	LOW-level output voltage	$I_{OL} = 3\text{ mA}$	-	-	0.4	V
$I_{CC(susp)}$	suspend supply current		-	1	-	μA

Table 123: Static characteristics: digital pins

$V_{CC(I/O)} = 3.0\text{ V to }3.6\text{ V}$; $T_{amb} = -40\text{ }^{\circ}\text{C to }+85\text{ }^{\circ}\text{C}$; unless otherwise specified.

Symbol	Parameter	Conditions	Min	Typ	Max	Unit
V_{IH}	HIGH-level input voltage		2.0	-	-	V
V_{IL}	LOW-level input voltage		-	-	0.8	V
V_{hys}	hysteresis voltage		0.4	-	0.7	V
V_{OL}	LOW-level output voltage	$I_{OL} = 3\text{ mA}$	-	-	0.4	V
V_{OH}	HIGH-level output voltage		2.4	-	-	V

Table 124: Static characteristics: PCI interface block

$V_{CC(I/O)} = 3.0\text{ V to }3.6\text{ V}$; $T_{amb} = -40\text{ }^{\circ}\text{C to }+85\text{ }^{\circ}\text{C}$; unless otherwise specified.

Symbol	Parameter	Conditions	Min	Typ	Max	Unit
V_{IH}	HIGH-level input voltage		2.0	-	5.5	V
V_{IL}	LOW-level input voltage		0	-	0.9	V
V_{IPU}	input pull-up voltage		2.1	-	-	V
I_{LI}	input leakage current	$0\text{ V} < V_I < V_{CC(I/O)}$	-10	-	+10	μA
V_{OH}	HIGH-level output voltage	$I_O = 500\text{ }\mu\text{A}$	2.7	-	-	V
V_{OL}	LOW-level output voltage	$I_O = 1500\text{ }\mu\text{A}$	-	-	0.3	V
C_{IN}	input pin capacitance		-	-	10	pF
C_{clk}	clock capacitance		5	-	12	pF
C_{IDSEL}	IDSEL pin capacitance		-	-	8	pF

Table 125: Static characteristics: USB interface block (pins DM1 to DM4 and DP1 to DP4)

$V_{DDA_AUX} = 3.0\text{ V to }3.6\text{ V}$; $T_{amb} = -40\text{ }^{\circ}\text{C to }+85\text{ }^{\circ}\text{C}$; unless otherwise specified.

Symbol	Parameter	Conditions	Min	Typ	Max	Unit
Input levels for high-speed						
V_{HSSQ}	squelch detection threshold (differential signal amplitude)	squelch detected	-	-	100	mV
		no squelch detected	150	-	-	mV
V_{HSDSC}	disconnect detection threshold (differential signal amplitude)	disconnect detected	625	-	-	mV
		disconnect not detected	-	-	525	mV
V_{HSCM}	data signaling common mode voltage range		-50	-	+500	mV

Table 125: Static characteristics: USB interface block (pins DM1 to DM4 and DP1 to DP4)...*continued**V_{DDA_AUX} = 3.0 V to 3.6 V; T_{amb} = -40 °C to +85 °C; unless otherwise specified.*

Symbol	Parameter	Conditions	Min	Typ	Max	Unit
Output levels for high-speed						
V _{HSOI}	idle state		-10	-	+10	mV
V _{HSOH}	data signaling HIGH		360	-	440	mV
V _{HSOL}	data signaling LOW		-10	-	+10	mV
V _{CHIRPJ}	Chirp J level (differential voltage)		700 ^[1]	-	1100	mV
V _{CHIRPK}	Chirp K level (differential voltage)		-900 ^[1]	-	-500	mV
Input levels for full-speed and low-speed						
V _{IH}	HIGH-level input voltage (drive)		2.0	-	-	V
V _{IHZ}	HIGH-level input voltage (floating)		2.7	-	3.6	V
V _{IL}	LOW-level input voltage		-	-	0.8	V
V _{DI}	differential input sensitivity	V _{DP} - V _{DM}	0.2	-	-	V
V _{CM}	differential common mode range		0.8	-	2.5	V
Output levels for full-speed and low-speed						
V _{OH}	HIGH-level output voltage		2.8	-	3.6	V
V _{OL}	LOW-level output voltage		0	-	0.3	V
V _{OSE1}	SE1		0.8	-	-	V
V _{CRS}	output signal crossover point voltage		1.3	-	2.0	V

[1] High-speed termination resistor disabled, pull-up resistor connected. Only during reset, when both the hub and device are capable of high-speed operation.

16. Dynamic characteristics

Table 126: Dynamic characteristics: system clock timing

Symbol	Parameter	Conditions	Min	Typ	Max	Unit
Reset						
$t_{W(\text{RESET_N})}$	pulse width on pin RESET_N	crystal oscillator running	-	10	-	μs
Crystal oscillator						
f_{clk}	PCI clock		31	-	33	MHz
	external clock input [1]	crystal [2]	-	12	-	MHz
		oscillator		-	48	-
R_S	series resistance		-	-	100	Ω
C_L	load capacitance		-	18	-	pF
External clock input						
V_I	input voltage		1.65	1.8	1.95	V
J	external clock jitter		-	-	50	ppm
$t_{\text{CR}}, t_{\text{CF}}$	rise time and fall time		-	-	3	ns
δ_{clk}	clock duty factor		-	50	-	%

[1] Recommended accuracy of the clock frequency is 50 ppm for the crystal and oscillator.

[2] Suggested values for external capacitors when using a crystal are 22 pF to 27 pF.

Table 127: Dynamic characteristics: I²C-bus interface (SDA and SCL)

$V_{\text{CC(I/O)}} = 3.0 \text{ V to } 3.6 \text{ V}$; $T_{\text{amb}} = -40^\circ\text{C to } +85^\circ\text{C}$; unless otherwise specified.

Symbol	Parameter	Conditions	Min	Typ	Max	Unit
t_{CF}	output fall time V_{IH} to V_{IL}	$10 < C_b < 400$ [1]	-	0	250	ns

[1] The capacitive load for each bus line (C_b) is specified in pF. To meet the specification for V_{OL} and the maximum rise time (300 ns), use an external pull-up resistor with $R_{\text{UP(max)}} = 850/C_b$ k Ω and $R_{\text{UP(min)}} = (V_{\text{CC(I/O)}} - 0.4)/3$ k Ω .

Table 128: Dynamic characteristics: PCI interface block

$V_{\text{CC(I/O)}} = 3.0 \text{ V to } 3.6 \text{ V}$; $T_{\text{amb}} = -40^\circ\text{C to } +85^\circ\text{C}$; unless otherwise specified.

Symbol	Parameter	Conditions	Min	Typ	Max	Unit
SR_{out}	output slew rate (rise, fall)	standard load	1	-	4	V/ns

[1] Standard load is 10 pF together with a pull-up and pull-down resistor of 10 k Ω .

Table 129: Dynamic characteristics: high-speed source electrical characteristics

$V_{\text{DDA_AUX}} = 3.0 \text{ V to } 3.6 \text{ V}$; $T_{\text{amb}} = -40^\circ\text{C to } +85^\circ\text{C}$; unless otherwise specified.

Symbol	Parameter	Conditions	Min	Typ	Max	Unit
Driver characteristics						
t_{HSR}	high-speed differential rise time	10 % to 90 %	500	-	-	ps
t_{HSF}	high-speed differential fall time	90 % to 10 %	500	-	-	ps
Z_{HSDRV}	drive output resistance; also serves as a high-speed termination	includes the R_S resistor	40.5	45	49.5	Ω

Table 129: Dynamic characteristics: high-speed source electrical characteristics...continued $V_{DDA_AUX} = 3.0\text{ V to }3.6\text{ V}$; $T_{amb} = -40\text{ }^{\circ}\text{C to }+85\text{ }^{\circ}\text{C}$; unless otherwise specified.

Symbol	Parameter	Conditions	Min	Typ	Max	Unit
Clock timing						
t_{HSDRAT}	high-speed data rate		479.76	-	480.24	Mbit/s
t_{HSFRAM}	micro frame interval		124.9375	-	125.0625	μs
t_{HSRFI}	consecutive micro frame interval difference		1	-	four high-speed bit times	ns

Table 130: Dynamic characteristics: full-speed source electrical characteristics $V_{DDA_AUX} = 3.0\text{ V to }3.6\text{ V}$; $T_{amb} = -40\text{ }^{\circ}\text{C to }+85\text{ }^{\circ}\text{C}$; unless otherwise specified.

Symbol	Parameter	Conditions	Min	Typ	Max	Unit
Driver characteristics						
t_{FR}	rise time	$C_L = 50\text{ pF}$; 10 % to 90 % of $ V_{OH} - V_{OL} $	4	-	20	ns
t_{FF}	fall time	$C_L = 50\text{ pF}$; 90 % to 10 % of $ V_{OH} - V_{OL} $	4	-	20	ns
t_{FRFM}	differential rise and fall time matching		90	-	111.1	%

Data timing; see Figure 10

t_{FDEOP}	source jitter for differential transition to SE0 transition	full-speed timing	-2	-	+5	ns
t_{FEOPT}	source SE0 interval of EOP		160	-	175	ns
t_{FEOPR}	receiver SE0 interval of EOP		82	-	-	ns
t_{LDEOP}	source jitter for differential transition to SE0 transition	low-speed timing	-40	-	+100	ns
t_{LEOPT}	source SE0 interval of EOP		1.25	-	1.5	μs
t_{LEOPR}	receiver SE0 interval of EOP		670	-	-	ns
t_{FST}	width of SE0 interval during the differential transaction		-	-	14	ns

Table 131: Dynamic characteristics: low-speed source electrical characteristics $V_{DDA_AUX} = 3.0\text{ V to }3.6\text{ V}$; $T_{amb} = -40\text{ }^{\circ}\text{C to }+85\text{ }^{\circ}\text{C}$; unless otherwise specified.

Symbol	Parameter	Conditions	Min	Typ	Max	Unit
Driver characteristics						
t_{LR}	rise time		75	-	300	ns
t_{LF}	fall time		75	-	300	ns
t_{LRFM}	rise and fall time matching		90	-	125	%

16.1 Timing

Table 132: PCI clock and I/O timing

Symbol	Parameter	Conditions	Min	Typ	Max	Unit
PCI clock timing; see Figure 7						
$T_{cyc}(PCICLK)$	PCICLK cycle time		30	-	32	ns
$t_{HIGH}(PCICLK)$	PCICLK HIGH time		11	-	-	ns
$t_{LOW}(PCICLK)$	PCICLK LOW time		11	-	-	ns
SR_{PCICLK}	PCICLK slew rate		1	-	4	V/ns
$SR_{RST\#}$	RST# slew rate		50	-	-	mV/ns
PCI input timing; see Figure 8						
$t_{su}(PCICLK)_{bs}$	setup time to PCICLK (bus signal)		7	-	-	ns
$t_{su}(PCICLK)_{ptp}$	setup time to PCICLK (point-to-point)	[1]	10	-	-	ns
$t_h(PCICLK)$	input hold time from PCICLK		0	-	-	ns
PCI output timing; see Figure 9						
$t_{val}(PCICLK)_{bs}$	PCICLK to signal valid delay (bus signal)		2	-	11	ns
$t_{val}(PCICLK)_{ptp}$	PCICLK to signal valid delay (point-to-point)	[1]	2	-	12	ns
$t_{dZ(act)}$	float to active delay		2	-	-	ns
$t_{d(act)Z}$	active to float delay		-	-	28	ns
PCI reset timing						
t_{rst}	reset active time after CLK stable		1	-	-	ms

[1] REQ# and GNT# are point-to-point signals. GNT# has a setup of 10 ns; REQ# has a setup of 12 ns. All others are bus signals.

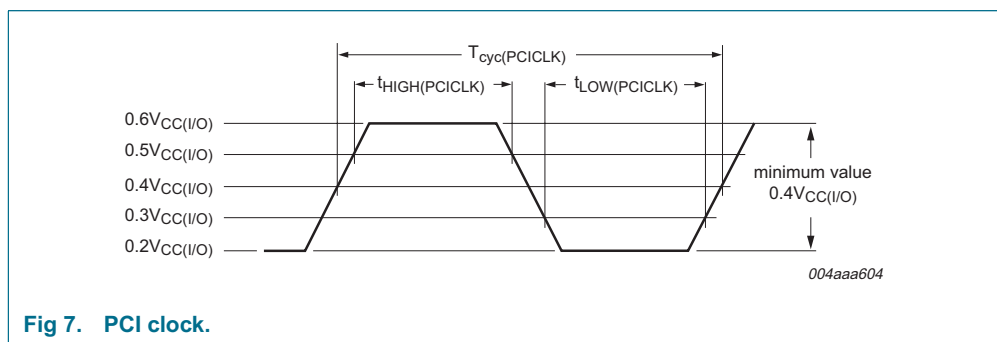

Fig 7. PCI clock.

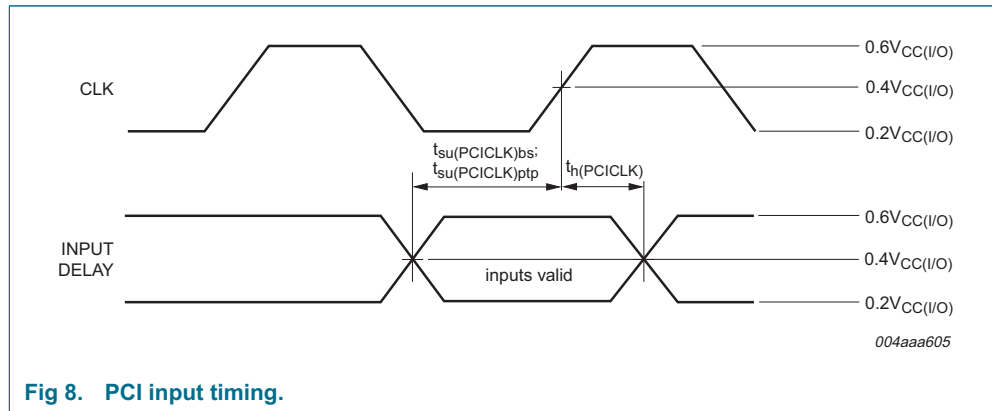

Fig 8. PCI input timing.

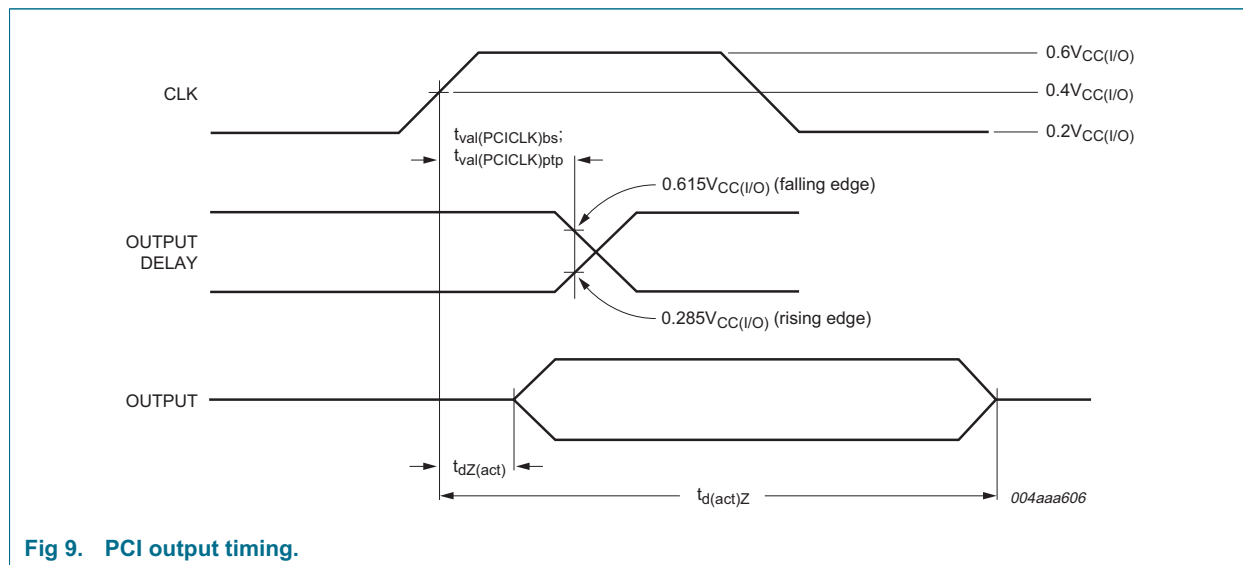
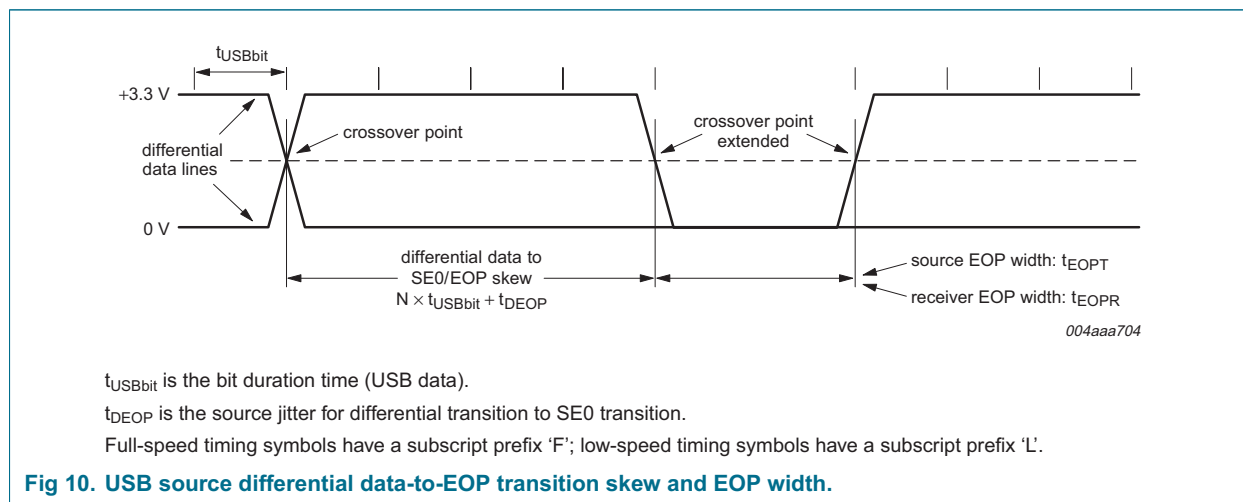

Fig 9. PCI output timing.



t_{USBbit} is the bit duration time (USB data).

t_{DEOP} is the source jitter for differential transition to SE0 transition.

Full-speed timing symbols have a subscript prefix 'F'; low-speed timing symbols have a subscript prefix 'L'.

Fig 10. USB source differential data-to-EOP transition skew and EOP width.

17. Package outline

LQFP128: plastic low profile quad flat package; 128 leads; body 14 x 14 x 1.4 mm

SOT420-1

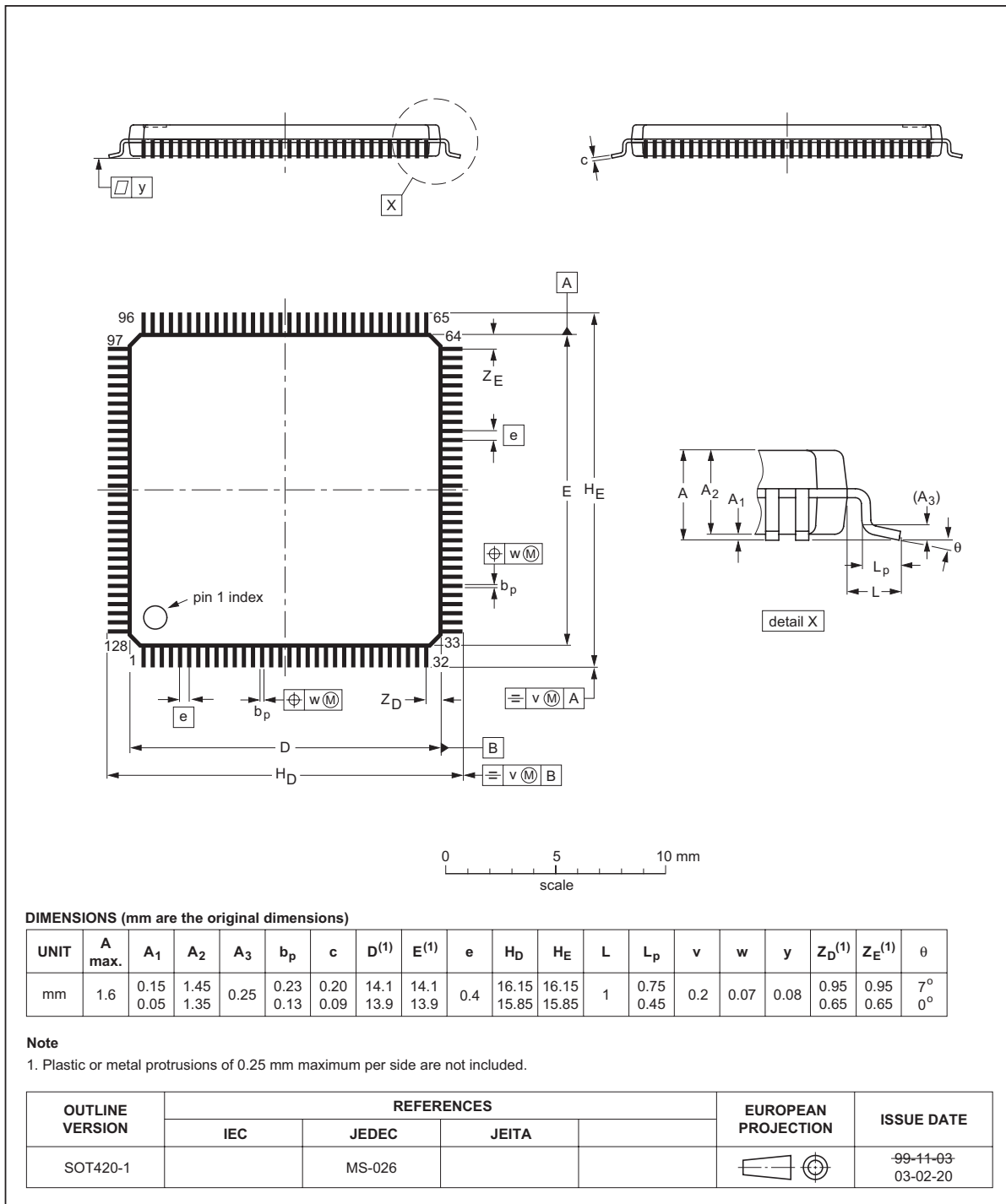

Fig 11. Package outline SOT420-1 (LQFP128).

18. Soldering

18.1 Introduction to soldering surface mount packages

This text gives a very brief insight to a complex technology. A more in-depth account of soldering ICs can be found in our *Data Handbook IC26; Integrated Circuit Packages* (document order number 9398 652 90011).

There is no soldering method that is ideal for all surface mount IC packages. Wave soldering can still be used for certain surface mount ICs, but it is not suitable for fine pitch SMDs. In these situations reflow soldering is recommended.

18.2 Reflow soldering

Reflow soldering requires solder paste (a suspension of fine solder particles, flux and binding agent) to be applied to the printed-circuit board by screen printing, stencilling or pressure-syringe dispensing before package placement. Driven by legislation and environmental forces the worldwide use of lead-free solder pastes is increasing.

Several methods exist for reflowing; for example, convection or convection/infrared heating in a conveyor type oven. Throughput times (preheating, soldering and cooling) vary between 100 seconds and 200 seconds depending on heating method.

Typical reflow peak temperatures range from 215 °C to 270 °C depending on solder paste material. The top-surface temperature of the packages should preferably be kept:

- below 225 °C (SnPb process) or below 245 °C (Pb-free process)
 - for all BGA, HTSSON..T and SSOP..T packages
 - for packages with a thickness ≥ 2.5 mm
 - for packages with a thickness < 2.5 mm and a volume ≥ 350 mm³ so called thick/large packages.
- below 240 °C (SnPb process) or below 260 °C (Pb-free process) for packages with a thickness < 2.5 mm and a volume < 350 mm³ so called small/thin packages.

Moisture sensitivity precautions, as indicated on packing, must be respected at all times.

18.3 Wave soldering

Conventional single wave soldering is not recommended for surface mount devices (SMDs) or printed-circuit boards with a high component density, as solder bridging and non-wetting can present major problems.

To overcome these problems the double-wave soldering method was specifically developed.

If wave soldering is used the following conditions must be observed for optimal results:

- Use a double-wave soldering method comprising a turbulent wave with high upward pressure followed by a smooth laminar wave.
- For packages with leads on two sides and a pitch (e):
 - larger than or equal to 1.27 mm, the footprint longitudinal axis is **preferred** to be parallel to the transport direction of the printed-circuit board;

- smaller than 1.27 mm, the footprint longitudinal axis **must** be parallel to the transport direction of the printed-circuit board.

The footprint must incorporate solder thieves at the downstream end.

- For packages with leads on four sides, the footprint must be placed at a 45° angle to the transport direction of the printed-circuit board. The footprint must incorporate solder thieves downstream and at the side corners.

During placement and before soldering, the package must be fixed with a droplet of adhesive. The adhesive can be applied by screen printing, pin transfer or syringe dispensing. The package can be soldered after the adhesive is cured.

Typical dwell time of the leads in the wave ranges from 3 seconds to 4 seconds at 250 °C or 265 °C, depending on solder material applied, SnPb or Pb-free respectively.

A mildly-activated flux will eliminate the need for removal of corrosive residues in most applications.

18.4 Manual soldering

Fix the component by first soldering two diagonally-opposite end leads. Use a low voltage (24 V or less) soldering iron applied to the flat part of the lead. Contact time must be limited to 10 seconds at up to 300 °C.

When using a dedicated tool, all other leads can be soldered in one operation within 2 seconds to 5 seconds between 270 °C and 320 °C.

18.5 Package related soldering information

Table 133: Suitability of surface mount IC packages for wave and reflow soldering methods

Package ^[1]	Soldering method	
	Wave	Reflow ^[2]
BGA, HTSSON..T ^[3] , LBGA, LFBGA, SQFP, SSOP..T ^[3] , TFBGA, VFBGA, XSON	not suitable	suitable
DHVQFN, HBCC, HBGA, HLQFP, HSO, HSOP, HSQFP, HSSON, HTQFP, HTSSOP, HVQFN, HVSON, SMS	not suitable ^[4]	suitable
PLCC ^[5] , SO, SOJ	suitable	suitable
LQFP, QFP, TQFP	not recommended ^[5] ^[6]	suitable
SSOP, TSSOP, VSO, VSSOP	not recommended ^[7]	suitable
CWQCCN..L ^[8] , PMFP ^[9] , WQCCN..L ^[8]	not suitable	not suitable

[1] For more detailed information on the BGA packages refer to the *(LF)BGA Application Note (AN01026)*; order a copy from your Philips Semiconductors sales office.

[2] All surface mount (SMD) packages are moisture sensitive. Depending upon the moisture content, the maximum temperature (with respect to time) and body size of the package, there is a risk that internal or external package cracks may occur due to vaporization of the moisture in them (the so called popcorn effect). For details, refer to the Drypack information in the *Data Handbook IC26; Integrated Circuit Packages; Section: Packing Methods*.

[3] These transparent plastic packages are extremely sensitive to reflow soldering conditions and must on no account be processed through more than one soldering cycle or subjected to infrared reflow soldering with peak temperature exceeding 217 °C ± 10 °C measured in the atmosphere of the reflow oven. The package body peak temperature must be kept as low as possible.

- [4] These packages are not suitable for wave soldering. On versions with the heatsink on the bottom side, the solder cannot penetrate between the printed-circuit board and the heatsink. On versions with the heatsink on the top side, the solder might be deposited on the heatsink surface.
- [5] If wave soldering is considered, then the package must be placed at a 45° angle to the solder wave direction. The package footprint must incorporate solder thieves downstream and at the side corners.
- [6] Wave soldering is suitable for LQFP, QFP and TQFP packages with a pitch (e) larger than 0.8 mm; it is definitely not suitable for packages with a pitch (e) equal to or smaller than 0.65 mm.
- [7] Wave soldering is suitable for SSOP, TSSOP, VSO and VSSOP packages with a pitch (e) equal to or larger than 0.65 mm; it is definitely not suitable for packages with a pitch (e) equal to or smaller than 0.5 mm.
- [8] Image sensor packages in principle should not be soldered. They are mounted in sockets or delivered pre-mounted on flex foil. However, the image sensor package can be mounted by the client on a flex foil by using a hot bar soldering process. The appropriate soldering profile can be provided on request.
- [9] Hot bar soldering or manual soldering is suitable for PMFP packages.

19. Abbreviations

Table 134: Abbreviations

Acronym	Description
BIOS	Basic Input Output System
CMOS	Complementary Metal-Oxide Semiconductor
DID	Device ID
EEPROM	Electrically Erasable Programmable Read-Only Memory
EHCI	Enhanced Host Controller Interface
EMI	Electro-Magnetic Interference
ESD	Electro-Static Discharge
HC	Host Controller
HCCA	Host Controller Communication Area
HCD	Host Controller Driver
OHCI	Open Host Controller Interface
OS	Operating System
PCI	Peripheral Component Interconnect
PCI-SIG	PCI-Special Interest Group
PLL	Phase-Locked Loop
PM	Power Management
PMC	Power Management Capabilities
PME	Power Management Event
PMCSR	Power Management Control/Status
POR	Power-On Reset
POST	Power On Self Test
STB	Set-Top Box
USB	Universal Serial Bus
VGA	Video Graphics Array
VID	Vendor ID



20. References

- [1] Universal Serial Bus Specification Rev. 2.0
- [2] Open Host Controller Interface Specification for USB Rev. 1.0a
- [3] Enhanced Host Controller Interface Specification for Universal Serial Bus Rev. 1.0
- [4] PCI Local Bus Specification Rev. 2.2
- [5] PCI Bus Power Management Interface Specification Rev. 1.1
- [6] The I²C-bus Specification, Version 2.1.

21. Revision history

Table 135: Revision history

Document ID	Release date	Data sheet status	Change notice	Doc. number	Supersedes
ISP1563_1	20050714	Product data sheet	-	9397 750 14224	-

22. Data sheet status

Level	Data sheet status ^[1]	Product status ^{[2] [3]}	Definition
I	Objective data	Development	This data sheet contains data from the objective specification for product development. Philips Semiconductors reserves the right to change the specification in any manner without notice.
II	Preliminary data	Qualification	This data sheet contains data from the preliminary specification. Supplementary data will be published at a later date. Philips Semiconductors reserves the right to change the specification without notice, in order to improve the design and supply the best possible product.
III	Product data	Production	This data sheet contains data from the product specification. Philips Semiconductors reserves the right to make changes at any time in order to improve the design, manufacturing and supply. Relevant changes will be communicated via a Customer Product/Process Change Notification (CPCN).

[1] Please consult the most recently issued data sheet before initiating or completing a design.

[2] The product status of the device(s) described in this data sheet may have changed since this data sheet was published. The latest information is available on the Internet at URL <http://www.semiconductors.philips.com>.

[3] For data sheets describing multiple type numbers, the highest-level product status determines the data sheet status.

23. Definitions

Short-form specification — The data in a short-form specification is extracted from a full data sheet with the same type number and title. For detailed information see the relevant data sheet or data handbook.

Limiting values definition — Limiting values given are in accordance with the Absolute Maximum Rating System (IEC 60134). Stress above one or more of the limiting values may cause permanent damage to the device. These are stress ratings only and operation of the device at these or at any other conditions above those given in the Characteristics sections of the specification is not implied. Exposure to limiting values for extended periods may affect device reliability.

Application information — Applications that are described herein for any of these products are for illustrative purposes only. Philips Semiconductors make no representation or warranty that such applications will be suitable for the specified use without further testing or modification.

24. Disclaimers

Life support — These products are not designed for use in life support appliances, devices, or systems where malfunction of these products can reasonably be expected to result in personal injury. Philips Semiconductors

customers using or selling these products for use in such applications do so at their own risk and agree to fully indemnify Philips Semiconductors for any damages resulting from such application.

Right to make changes — Philips Semiconductors reserves the right to make changes in the products - including circuits, standard cells, and/or software - described or contained herein in order to improve design and/or performance. When the product is in full production (status 'Production'), relevant changes will be communicated via a Customer Product/Process Change Notification (CPCN). Philips Semiconductors assumes no responsibility or liability for the use of any of these products, conveys no license or title under any patent, copyright, or mask work right to these products, and makes no representations or warranties that these products are free from patent, copyright, or mask work right infringement, unless otherwise specified.

25. Trademarks

Notice — All referenced brands, product names, service names and trademarks are the property of their respective owners.

I²C-bus — wordmark and logo are trademarks of Koninklijke Philips Electronics N.V.

26. Contact information

For additional information, please visit: <http://www.semiconductors.philips.com>

For sales office addresses, send an email to: sales.addresses@www.semiconductors.philips.com

27. Tables

Table 1: Ordering information	3	(address 61h) bit allocation	26
Table 2: Pin description	5	Table 28: FLADJ - Frame Length Adjustment register (address 61h) bit description	26
Table 3: PCI configuration space registers of OHCI1, OHCI2 and EHCI	16	Table 29: PORTWAKECAP - Port Wake Capability register (address 62h) bit description	27
Table 4: VID - Vendor ID register (address 00h) bit description	17	Table 30: Power Management registers	27
Table 5: DID - Device ID register (address 02h) bit description	17	Table 31: Cap_ID - Capability Identifier register bit description	27
Table 6: Command register (address 04h) bit allocation	17	Table 32: Next_Item_Ptr - Next Item Pointer register bit description	27
Table 7: Command register (address 04h) bit description	18	Table 33: PMC - Power Management Capabilities register bit allocation	28
Table 8: Status register (address 06h) bit allocation . .	19	Table 34: PMC - Power Management Capabilities register bit description	28
Table 9: Status register (address 06h) bit description .	19	Table 35: PMCSR - Power Management Control/Status register bit allocation	30
Table 10: REVID - Revision ID register (address 08h) bit description	20	Table 36: PMCSR - Power Management Control/Status register bit description	30
Table 11: Class Code register (address 09h) bit allocation	21	Table 37: PMCSR_BSE - PMCSR PCI-to-PCI Bridge Support Extensions register bit allocation	31
Table 12: Class Code register (address 09h) bit description	21	Table 38: PMCSR_BSE - PMCSR PCI-to-PCI Bridge Support Extensions register bit description	32
Table 13: CLS - CacheLine Size register (address 0Ch) bit description	22	Table 39: PCI bus power and clock control	32
Table 14: LT - Latency Timer register (address 0Dh) bit description	22	Table 40: Data register bit description	32
Table 15: Header Type register (address 0Eh) bit allocation	22	Table 41: USB Host Controller registers	36
Table 16: Header Type register (address 0Eh) bit description	22	Table 42: HcRevision - Host Controller Revision register bit allocation	38
Table 17: BAR 0 - Base Address register 0 (address 10h) bit description	23	Table 43: HcRevision - Host Controller Revision register bit description	39
Table 18: SVID - Subsystem Vendor ID register (address 2Ch) bit description	23	Table 44: HcControl - Host Controller Control register bit allocation	39
Table 19: SID - Subsystem ID register (address 2Eh) bit description	23	Table 45: HcControl - Host Controller Control register bit description	40
Table 20: CP - Capabilities Pointer register (address 34h) bit description	24	Table 46: HcCommandStatus - Host Controller Command Status register bit allocation	42
Table 21: IL - Interrupt Line register (address 3Ch) bit description	24	Table 47: HcCommandStatus - Host Controller Command Status register bit description	42
Table 22: IP - Interrupt Pin register (address 3Dh) bit description	24	Table 48: HcInterruptStatus - Host Controller Interrupt Status register bit allocation	43
Table 23: Min_Gnt - Minimum Grant register (address 3Eh) bit description	24	Table 49: HcInterruptStatus - Host Controller Interrupt Status register bit description	44
Table 24: Max_Lat - Maximum Latency register (address 3Fh) bit description	25	Table 50: HcInterruptEnable - Host Controller Interrupt Enable register bit allocation	45
Table 25: EHCI-specific PCI registers	25	Table 51: HcInterruptEnable - Host Controller Interrupt Enable register bit description	45
Table 26: SBRN - Serial Bus Release Number register (address 60h) bit description	26	Table 52: HcInterruptDisable - Host Controller Interrupt Disable register bit allocation	46
Table 27: FLADJ - Frame Length Adjustment register (address 61h) bit allocation	26	Table 53: HcInterruptDisable - Host Controller	

continued >>

Interrupt Disable register bit description	47	Table 75: HcPeriodicStart - Host Controller Periodic Start register bit description	56
Table 54: HcHCCA - Host Controller Communication Area register bit allocation	48	Table 76: HcLSThreshold - Host Controller LS Threshold register bit allocation	57
Table 55: HcHCCA - Host Controller Communication Area register bit description	48	Table 77: HcLSThreshold - Host Controller LS Threshold register bit description	57
Table 56: HcPeriodCurrentED - Host Controller Period Current Endpoint Descriptor register bit allocation	48	Table 78: HcRhDescriptorA - Host Controller Root Hub Descriptor A register bit allocation	57
Table 57: HcPeriodCurrentED - Host Controller Period Current Endpoint Descriptor register bit description	49	Table 79: HcRhDescriptorA - Host Controller Root Hub Descriptor A register bit description	58
Table 58: HcControlHeadED - Host Controller Control Head Endpoint Descriptor register bit allocation	49	Table 80: HcRhDescriptorB - Host Controller Root Hub Descriptor B register bit allocation	59
Table 59: HcControlHeadED - Host Controller Control Head Endpoint Descriptor register bit description	50	Table 81: HcRhDescriptorB - Host Controller Root Hub Descriptor B register bit description	60
Table 60: HcControlCurrentED - Host Controller Control Current Endpoint Descriptor register bit allocation	50	Table 82: HcRhStatus - Host Controller Root Hub Status register bit allocation	60
Table 61: HcControlCurrentED - Host Controller Control Current Endpoint Descriptor register bit description	50	Table 83: HcRhStatus - Host Controller Root Hub Status register bit description	61
Table 62: HcBulkHeadED - Host Controller Bulk Head Endpoint Descriptor register bit allocation	51	Table 84: HcRhPortStatus[4:1] - Host Controller Root Hub Port Status[4:1] register bit allocation	62
Table 63: HcBulkHeadED - Host Controller Bulk Head Endpoint Descriptor register bit description	51	Table 85: HcRhPortStatus[4:1] - Host Controller Root Hub Port Status[4:1] register bit description	62
Table 64: HcBulkCurrentED - Host Controller Bulk Current Endpoint Descriptor register bit allocation	51	Table 86: Legacy support registers	66
Table 65: HcBulkCurrentED - Host Controller Bulk Current Endpoint Descriptor register bit description	52	Table 87: Emulated registers	66
Table 66: HcDoneHead - Host Controller Done Head register bit allocation	52	Table 88: HceControl - Host Controller Emulation Control register bit allocation	66
Table 67: HcDoneHead - Host Controller Done Head register bit description	53	Table 89: HceControl - Host Controller Emulation Control register bit description	67
Table 68: HcFmInterval - Host Controller Frame Interval register bit allocation	53	Table 90: HceInput - Host Controller Emulation Input register bit allocation	68
Table 69: HcFmInterval - Host Controller Frame Interval register bit description	54	Table 91: HceInput - Host Controller Emulation Input register bit description	68
Table 70: HcFmRemaining - Host Controller Frame Remaining register bit allocation	54	Table 92: HceOutput - Host Controller Emulation Output register bit allocation	68
Table 71: HcFmRemaining - Host Controller Frame Remaining register bit description	55	Table 93: HceOutput - Host Controller Emulation Output register bit description	69
Table 72: HcFmNumber - Host Controller Frame Number register bit allocation	55	Table 94: HceStatus - Host Controller Emulation Status register bit allocation	69
Table 73: HcFmNumber - Host Controller Frame Number register bit description	56	Table 95: HceStatus - Host Controller Emulation Status register bit description	70
Table 74: HcPeriodicStart - Host Controller Periodic Start register bit allocation	56	Table 96: CAPLENGTH/HCIVERSION - Capability Registers Length/Host Controller Interface Version Number register bit allocation	70
		Table 97: CAPLENGTH/HCIVERSION - Capability Registers Length/Host Controller Interface Version Number register bit description	71
		Table 98: HCSPARAMS - Host Controller Structural Parameters register bit allocation	71
		Table 99: HCSPARAMS - Host Controller Structural Parameters register bit description	72
		Table 100: HCCPARAMS - Host Controller Capability	

continued >>

Parameters register bit allocation	73	electrical characteristics	93
Table 101:HCCPARAMS - Host Controller Capability Parameters register bit description	73	Table 131:Dynamic characteristics: low-speed source electrical characteristics	93
Table 102:USBCMD - USB Command register bit allocation	74	Table 132:PCI clock and I/O timing	94
Table 103:USBCMD - USB Command register bit description	75	Table 133:Suitability of surface mount IC packages for wave and reflow soldering methods	98
Table 104:USBSTS - USB Status register bit allocation	77	Table 134:Abbreviations	99
Table 105:USBSTS - USB Status register bit description	77	Table 135:Revision history	100
Table 106:USBINTR - USB Interrupt Enable register bit allocation	79		
Table 107:USBINTR - USB Interrupt Enable register bit description	79		
Table 108:FRINDEX - Frame Index register bit allocation	80		
Table 109:FRINDEX - Frame Index register bit description	80		
Table 110:PERIODICLISTBASE - Periodic Frame List Base Address register bit allocation	81		
Table 111:PERIODICLISTBASE - Periodic Frame List Base Address register bit description	82		
Table 112:ASYNCLISTADDR - Current Asynchronous List Address register bit allocation	82		
Table 113:ASYNCLISTADDR - Current Asynchronous List Address register bit description	83		
Table 114:CONFIGFLAG - Configure Flag register bit allocation	83		
Table 115:CONFIGFLAG - Configure Flag register bit description	83		
Table 116:PORTSC 1, 2, 3, 4 - Port Status and Control, 1, 2, 3, 4 register bit allocation	84		
Table 117:PORTSC 1, 2, 3, 4 - Port Status and Control, 1, 2, 3, 4 register bit description	84		
Table 118:Power consumption when SEL2PORTS is LOW	88		
Table 119:Power consumption: S1 and S3	88		
Table 120:Limiting values	89		
Table 121:Recommended operating conditions	89		
Table 122:Static characteristics: I ² C-bus interface (SDA and SCL)	90		
Table 123:Static characteristics: digital pins	90		
Table 124:Static characteristics: PCI interface block	90		
Table 125:Static characteristics: USB interface block (pins DM1 to DM4 and DP1 to DP4)	90		
Table 126:Dynamic characteristics: system clock timing	92		
Table 127:Dynamic characteristics: I ² C-bus interface (SDA and SCL)	92		
Table 128:Dynamic characteristics: PCI interface block	92		
Table 129:Dynamic characteristics: high-speed source electrical characteristics	92		
Table 130:Dynamic characteristics: full-speed source			

continued >>



28. Figures

Fig 1.	Block diagram.	4
Fig 2.	Pin configuration.	5
Fig 3.	Power-on reset.	13
Fig 4.	Power supply connection.	14
Fig 5.	EEPROM connection diagram.	33
Fig 6.	Information loading from EEPROM.	34
Fig 7.	PCI clock.	94
Fig 8.	PCI input timing.	95
Fig 9.	PCI output timing.	95
Fig 10.	USB source differential data-to-EOP transition skew and EOP width.	95
Fig 11.	Package outline SOT420-1 (LQFP128).	96

continued >>

29. Contents

1	General description	1	8.2.2.2	FLADJ register	26
2	Features	2	8.2.2.3	PORTWAKECAP register	26
3	Applications	2	8.2.3	Power management registers	27
4	Ordering information	3	8.2.3.1	Cap_ID register	27
5	Block diagram	4	8.2.3.2	Next_Item_Ptr register	27
6	Pinning information	5	8.2.3.3	PMC register	28
6.1	Pinning	5	8.2.3.4	PMCSR register	30
6.2	Pin description	5	8.2.3.5	PMCSR_BSE register	31
7	Functional description	12	8.2.3.6	Data register	32
7.1	OHCI Host Controller	12	9	I²C-bus interface	33
7.2	EHCI Host Controller	12	9.1	Protocol	33
7.3	Dynamic port-routing logic	12	9.2	Hardware connections	33
7.4	Hi-Speed USB analog transceivers	12	9.3	Information loading from EEPROM	34
7.5	LED indicators for downstream ports	12	10	Power management	34
7.6	Power management	12	10.1	PCI bus power states	34
7.7	Legacy support	13	10.2	USB bus states	35
7.8	Phase-Locked Loop (PLL)	13	11	USB Host Controller registers	35
7.9	Power-On Reset (POR)	13	11.1	OHCI USB Host Controller operational registers	38
7.10	Power supply	13	11.1.1	HcRevision register	38
8	PCI	14	11.1.2	HcControl register	39
8.1	PCI interface	14	11.1.3	HcCommandStatus register	41
8.1.1	PCI configuration space	15	11.1.4	HcInterruptStatus register	43
8.1.2	PCI initiator and target	15	11.1.5	HcInterruptEnable register	45
8.2	PCI configuration registers	15	11.1.6	HcInterruptDisable register	46
8.2.1	PCI configuration header registers	16	11.1.7	HcHCCA register	48
8.2.1.1	Vendor ID register	17	11.1.8	HcPeriodCurrentED register	48
8.2.1.2	Device ID register	17	11.1.9	HcControlHeadED register	49
8.2.1.3	Command register	17	11.1.10	HcControlCurrentED register	50
8.2.1.4	Status register	19	11.1.11	HcBulkHeadED register	51
8.2.1.5	Revision ID register	20	11.1.12	HcBulkCurrentED register	51
8.2.1.6	Class Code register	21	11.1.13	HcDoneHead register	52
8.2.1.7	CacheLine Size register	21	11.1.14	HcFmInterval register	53
8.2.1.8	Latency Timer register	22	11.1.15	HcFmRemaining register	54
8.2.1.9	Header Type register	22	11.1.16	HcFmNumber register	55
8.2.1.10	Base Address register 0	22	11.1.17	HcPeriodicStart register	56
8.2.1.11	Subsystem Vendor ID register	23	11.1.18	HcLSThreshold register	57
8.2.1.12	Subsystem ID register	23	11.1.19	HcRhDescriptorA register	57
8.2.1.13	Capabilities Pointer register	23	11.1.20	HcRhDescriptorB register	59
8.2.1.14	Interrupt Line register	24	11.1.21	HcRhStatus register	60
8.2.1.15	Interrupt Pin register	24	11.1.22	HcRhPortStatus[4:1] register	61
8.2.1.16	Min_Gnt and Max_Lat registers	24	11.2	USB legacy support registers	66
8.2.1.17	TRDY Timeout register	25	11.2.1	HceControl register	66
8.2.1.18	Retry Timeout register	25	11.2.2	HceInput register	67
8.2.2	Enhanced Host Controller-specific PCI registers	25	11.2.3	HceOutput register	68
8.2.2.1	SBRN register	25	11.2.4	HceStatus register	69
			11.3	EHCI controller capability registers	70

continued >>

11.3.1	CAPLENGTH/HCVERSION register	70
11.3.2	HCSPARAMS register	71
11.3.3	HCCPARAMS register	73
11.3.4	HCSP-PORTROUTE register	74
11.4	Operational registers of Enhanced USB Host Controller	74
11.4.1	USBCMD register	74
11.4.2	USBSTS register	76
11.4.3	USBINTR register	78
11.4.4	FRINDEX register	80
11.4.5	PERIODICLISTBASE register	81
11.4.6	ASYNCLISTADDR register	82
11.4.7	CONFIGFLAG register	83
11.4.8	PORTSC registers 1, 2, 3, 4	83
12	Power consumption	88
13	Limiting values	89
14	Recommended operating conditions	89
15	Static characteristics	90
16	Dynamic characteristics	92
16.1	Timing	94
17	Package outline	96
18	Soldering	97
18.1	Introduction to soldering surface mount packages	97
18.2	Reflow soldering	97
18.3	Wave soldering	97
18.4	Manual soldering	98
18.5	Package related soldering information	98
19	Abbreviations	99
20	References	100
21	Revision history	100
22	Data sheet status	101
23	Definitions	101
24	Disclaimers	101
25	Trademarks	101
26	Contact information	101



© Koninklijke Philips Electronics N.V. 2005

All rights are reserved. Reproduction in whole or in part is prohibited without the prior written consent of the copyright owner. The information presented in this document does not form part of any quotation or contract, is believed to be accurate and reliable and may be changed without notice. No liability will be accepted by the publisher for any consequence of its use. Publication thereof does not convey nor imply any license under patent- or other industrial or intellectual property rights.

Date of release: 14 July 2005
Document number: 9397 750 14224

Published in The Netherlands