

DS15BA101

1.5 Gbps Differential Buffer with Adjustable Output Voltage

General Description

The DS15BA101 is a high-speed differential buffer for cable driving, level translation, signal buffering, and signal repeating applications. Its fully differential signal path ensures exceptional signal integrity and noise immunity and it drives both differential and single-ended transmission lines at data rates in excess of 1.5 Gbps.

Output voltage amplitude is adjustable via a single external resistor for level translation and cable driving applications into 50-ohm single-ended and 100-ohm differential mode impedances.

The DS15BA101 is powered from a single 3.3V supply and consumes 150 mW (typ) at 1.5 Gbps. It operates over the full -40°C to +85°C industrial temperature range and is available in a space saving 3x3 mm LLP-8 package.

Features

- Data rates from DC to 1.5+ Gbps
- Differential or single-ended input
- Adjustable output amplitude
- Single 3.3V supply
- Industrial -40°C to +85°C temperature
- Low power: 150 mW (typ) at 1.5 Gbps
- Space-saving 3 x 3 mm LLP-8 package

Applications

- Cable extension applications
- Level translation
- Signal buffering and repeating
- Security cameras

Typical Application

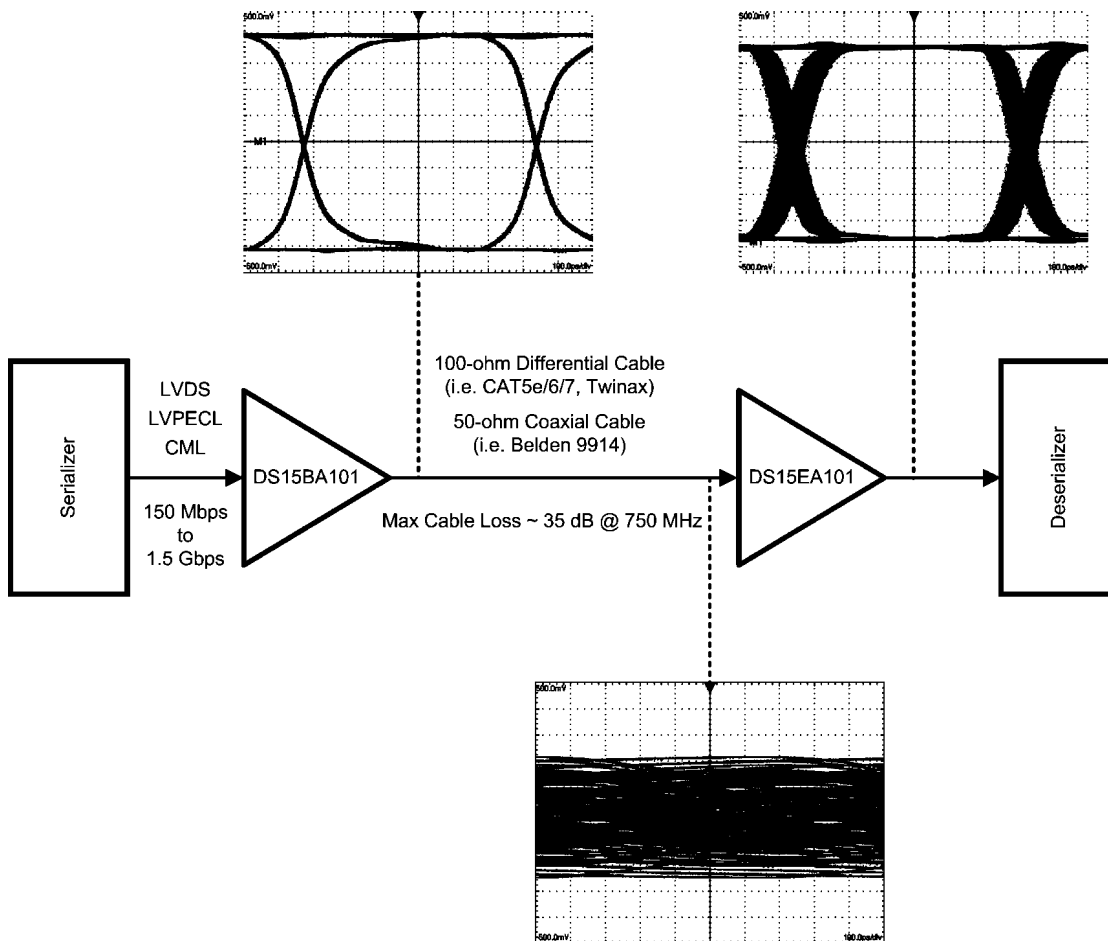

20199902

Absolute Maximum Ratings (Note 1)

Supply Voltage:	-0.5V to 3.6V
Input Voltage (all inputs)	-0.3V to $V_{CC}+0.3V$
Output Current	28 mA
Storage Temperature Range	-65°C to +150°C
Junction Temperature	+150°C
Lead Temperature (Soldering 4 Sec)	+260°C
Package Thermal Resistance	
θ_{JA} LLP-8	+90.7°C/W
θ_{JC} LLP-8	+41.2°C/W

ESD Rating (HBM)

5 kV

ESD Rating (MM)

250V

Recommended Operating Conditions

Supply Voltage ($V_{CC} - GND$):	3.3V \pm 5%
Operating Free Air Temperature (T_A) DS15BA101SD	-40°C to +85°C

DC Electrical Characteristics

Over Supply Voltage and Operating Temperature ranges, unless otherwise specified (Notes 2, 3).

Symbol	Parameter	Conditions	Reference	Min	Typ	Max	Units
V_{ICM}	Input Common Mode Voltage	(Note 4)	IN+, IN-	0.8		$V_{CC} - V_{ID}/2$	V
V_{ID}	Differential Input Voltage Swing			100		2000	mV _{P-P}
V_{OS}	Output Common Mode Voltage		OUT+, OUT-		$V_{CC} - V_{OUT}/2$		V
V_{OUT}	Output Voltage	Single-ended, 25 Ω load $R_{VO} = 953\Omega$ 1%,			400		mV _{P-P}
		Single-ended, 25 Ω load $R_{VO} = 487\Omega$ 1%,			800		mV _{P-P}
I_{CC}	Supply Current	(Note 5)			45	49	mA

AC Electrical Characteristics

Over Supply Voltage and Operating Temperature ranges, unless otherwise specified (Note 3).

Symbol	Parameter	Conditions	Reference	Min	Typ	Max	Units
DR_{MAX}	Maximum Data Rate	(Note 4)	IN+, IN-	1.5	2.0		Gbps
t_{LHT}	Output Low to High Transition Time	20% – 80% (Note 6)	OUT+, OUT-		120	220	ps
t_{HLT}	Output High to Low Transition Time				120	220	ps
t_{PLHD}	Propagation Low to High Delay	(Note 4)		0.95	1.10	1.35	ns
t_{PHLD}	Propagation High to Low Delay	(Note 4)		0.95	1.10	1.35	ns
t_{TJ}	Total Jitter	1.5 Gbps			26		ps _{P-P}

Note 1: "Absolute Maximum Ratings" are those parameter values beyond which the life and operation of the device cannot be guaranteed. The stating herein of these maximums shall not be construed to imply that the device can or should be operated at or beyond these values. The table of "Electrical Characteristics" specifies acceptable device operating conditions.

Note 2: Current flow into device pins is defined as positive. Current flow out of device pins is defined as negative. All voltages are stated referenced to GND.

Note 3: Typical values are stated for $V_{CC} = +3.3V$ and $T_A = +25^\circ C$.

Note 4: Specification is guaranteed by characterization.

Note 5: Maximum I_{CC} is measured at $V_{CC} = +3.465V$ and $T_A = +70^\circ C$.

Note 6: Specification is guaranteed by characterization and verified by test.

Connection Diagram

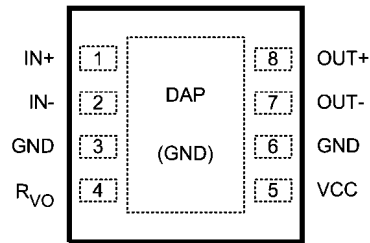

20199901

8-Pad LLP

Order Number DS15BA101SD or DS15BA101SDX
See NS Package Number SDA08A

Pin Descriptions

Pin #	Name	Description
1	IN+	Non-inverting input pin.
2	IN-	Inverting input pin.
3	GND	Circuit common (ground reference).
4	R_{VO}	Output voltage amplitude control. Connect a resistor to V_{CC} to set output voltage.
5	V_{CC}	Positive power supply (+3.3V).
6	GND	Circuit common (ground reference).
7	OUT-	Inverting output pin.
8	OUT+	Non-inverting output pin.

Device Operation

INPUT INTERFACING

The DS15BA101 accepts either differential or single-ended input. The inputs are self-biased, allowing for simple AC or DC coupling. DC-coupled inputs must be kept within the spec-

ified common-mode range. The IN+ and IN- pins are self-biased at approximately 2.1V with $V_{CC} = 3.3V$. The following three figures illustrate typical DC-coupled interface to common differential drivers.

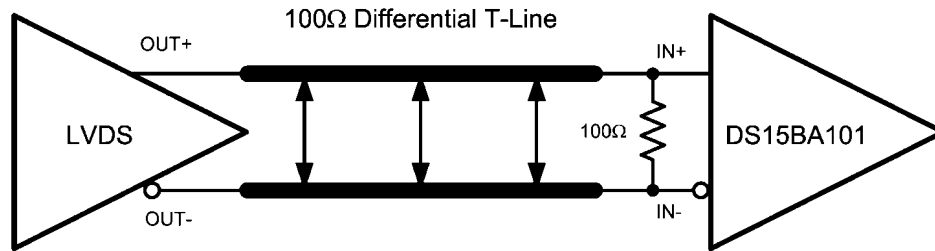

20199920

Typical LVDS Driver DC-Coupled Interface to DS15BA101 Input

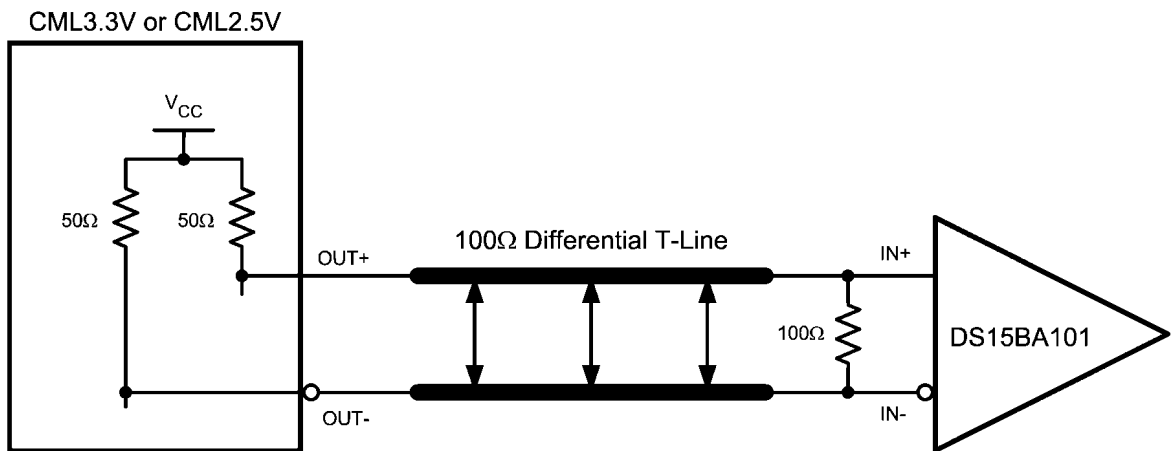

20199921

Typical CML Driver DC-Coupled Interface to DS15BA101 Input

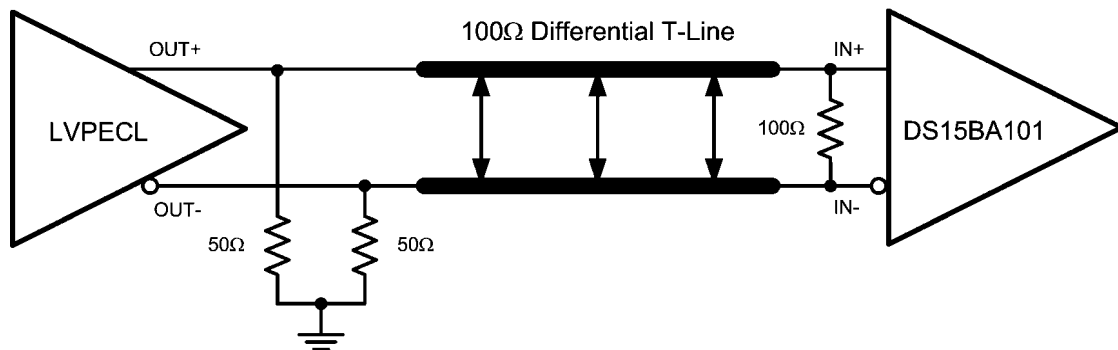

20199922

Typical LVPECL Driver DC-Coupled Interface to DS15BA101 Input

OUTPUT INTERFACING

The DS15BA101 uses current mode outputs. Single-ended output levels are 400 mV_{P-P} into AC-coupled 100Ω differential cable (with $R_{VO} = 953\Omega$) or into AC-coupled 50Ω coaxial cable (with $R_{VO} = 487\Omega$). Output level is controlled by the value of the R_{VO} resistor connected between the R_{VO} and V_{CC} .

The R_{VO} resistor should be placed as close as possible to the R_{VO} pin. In addition, the copper in the plane layers below the

R_{VO} network should be removed to minimize parasitic capacitance. The following figure illustrates typical DC-coupled interface to common differential receivers and assumes that the receivers have high impedance inputs. While most receivers have a common mode input range that can accommodate CML signals, it is recommended to check respective receiver's datasheet prior to implementing the suggested interface implementation.

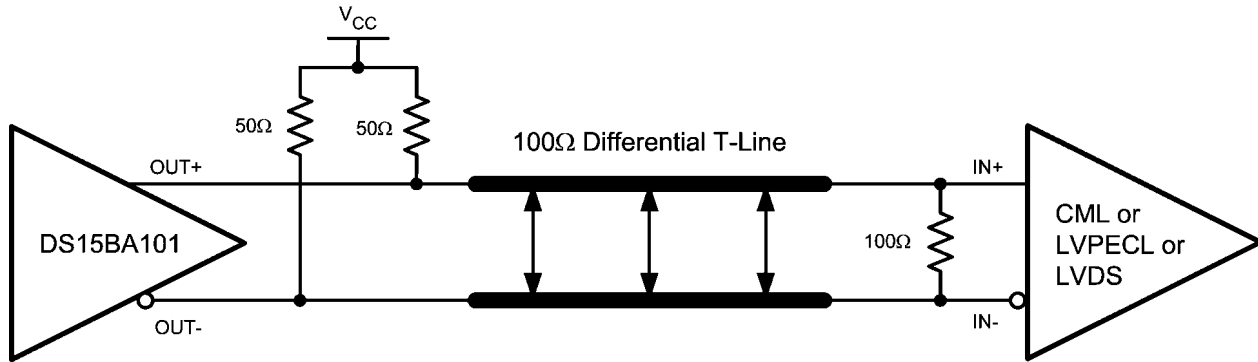

Typical DS15BA101 Output DC-Coupled Interface to an LVDS, CML or LVPECL Receiver

20199923

CABLE EXTENDER APPLICATION

The DS15BA101 together with the DS15EA101 form a cable extender chipset optimized for extending serial data streams from serializer/deserializer (SerDes) pairs and field programmable gate arrays (FPGAs) over 100Ω differential (i.e.

CAT5e/6/7 and twinax) and 50Ω coaxial cables. Setting correct DS15BA101 output amplitude and proper cable termination are keys for optimal operation. The following two figures show recommended chipset configuration for 100Ω differential and 50Ω coaxial cables.

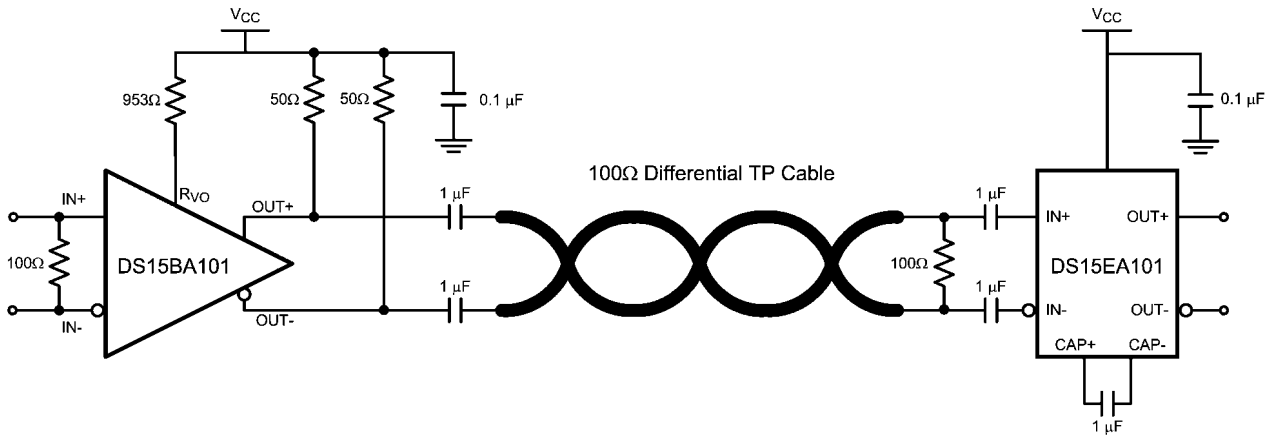

20199905

Cable Extender Chipset Connection Diagram for 100Ω Differential Cables

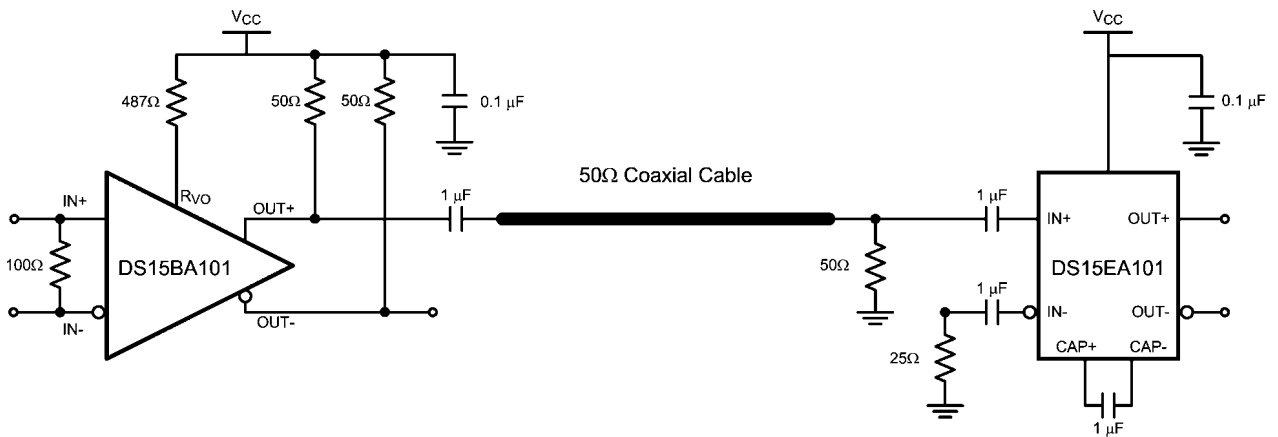

20199906

Cable Extender Chipset Connection Diagram for 50Ω Coaxial Cables

REFERENCE DESIGN

There is a complete reference design (P/N: DriveCable02EVK) available for evaluation of the cable extender chipset (DS15BA101 and DS15EA101). For more information visit <http://www.national.com/appinfo/lvds/drivecable02evk.html>.

Typical Performance

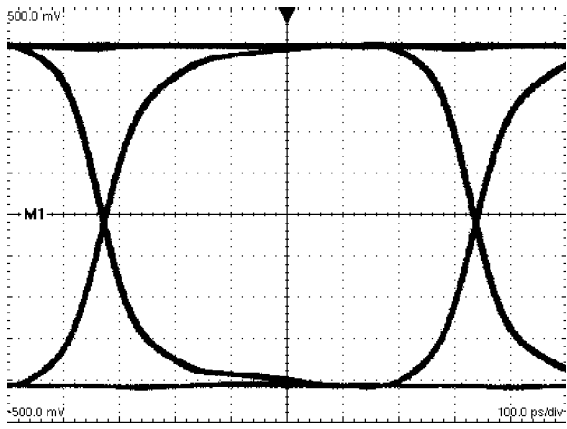

1.5 Gbps Differential DS15BA101 Output
 $R_{VO} = 953\Omega$, H:100 ps / DIV, V:100 mV / DIV

20199910

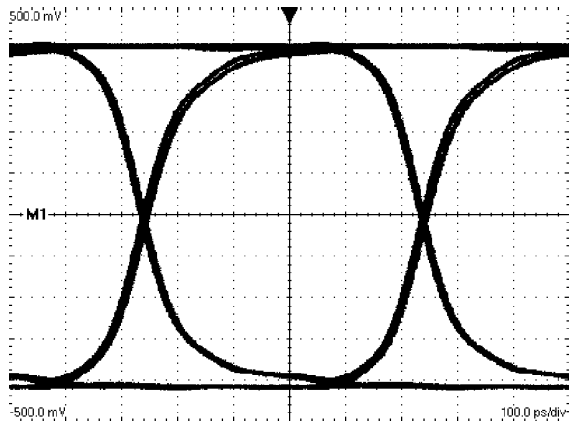

2.0 Gbps Differential DS15BA101 Output
 $R_{VO} = 953\Omega$, H:100 ps / DIV, V:100 mV / DIV

20199911

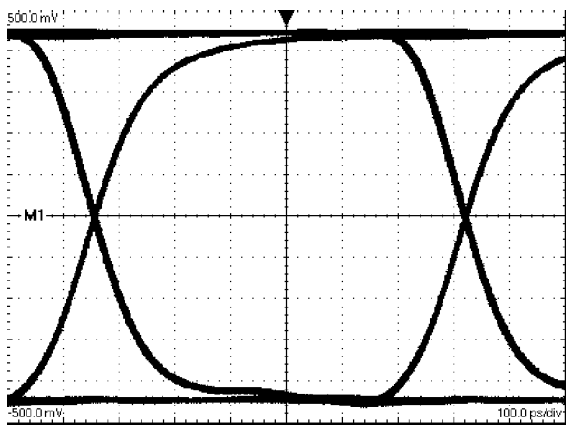

1.5 Gbps Single-ended DS15BA101 Output
 $R_{VO} = 487\Omega$, H:100 ps / DIV, V:100 mV / DIV

20199912

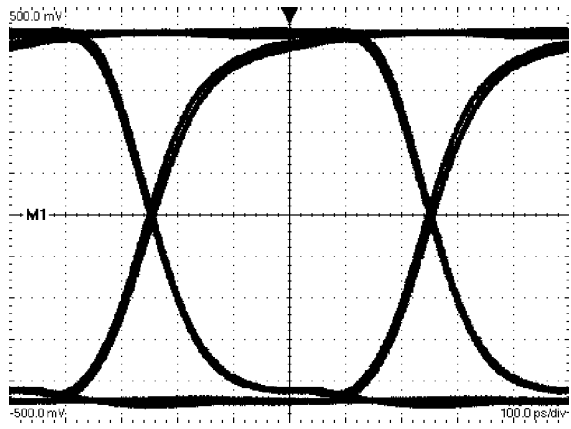

2.0 Gbps Single-ended DS15BA101 Output
 $R_{VO} = 487\Omega$, H:100 ps / DIV, V:100 mV / DIV

20199913

Physical Dimensions inches (millimeters) unless otherwise noted

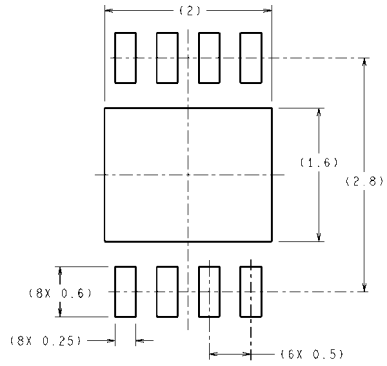

RECOMMENDED LAND PATTERN

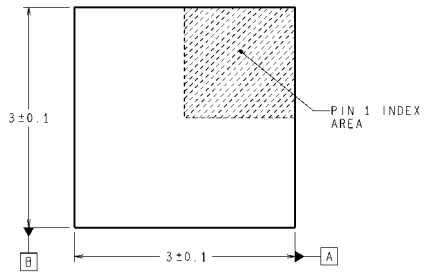

DIMENSIONS ARE IN MILLIMETERS
DIMENSIONS IN () FOR REFERENCE ONLY

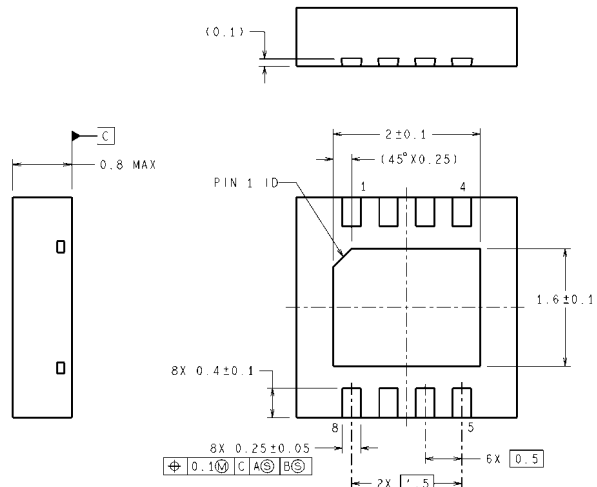

SDA08A (Rev A)

8-Pad LLP
Order Number DS15BA101SD or DS15BA101SDX
NS Package Number SDA08A
(See AN-1187 for PCB Design and Assembly Recommendations)

Notes

DS15BA101

Notes

For more National Semiconductor product information and proven design tools, visit the following Web sites at:

Products		Design Support	
Amplifiers	www.national.com/amplifiers	WEBENCH® Tools	www.national.com/webench
Audio	www.national.com/audio	App Notes	www.national.com/appnotes
Clock and Timing	www.national.com/timing	Reference Designs	www.national.com/refdesigns
Data Converters	www.national.com/adc	Samples	www.national.com/samples
Interface	www.national.com/interface	Eval Boards	www.national.com/evalboards
LVDS	www.national.com/lvds	Packaging	www.national.com/packaging
Power Management	www.national.com/power	Green Compliance	www.national.com/quality/green
Switching Regulators	www.national.com/switchers	Distributors	www.national.com/contacts
LDOs	www.national.com/ldo	Quality and Reliability	www.national.com/quality
LED Lighting	www.national.com/led	Feedback/Support	www.national.com/feedback
Voltage Reference	www.national.com/vref	Design Made Easy	www.national.com/easy
PowerWise® Solutions	www.national.com/powerwise	Solutions	www.national.com/solutions
Serial Digital Interface (SDI)	www.national.com/sdi	Mil/Aero	www.national.com/milaero
Temperature Sensors	www.national.com/tempsensors	SolarMagic™	www.national.com/solarmagic
Wireless (PLL/VCO)	www.national.com/wireless	Analog University®	www.national.com/AU

THE CONTENTS OF THIS DOCUMENT ARE PROVIDED IN CONNECTION WITH NATIONAL SEMICONDUCTOR CORPORATION ("NATIONAL") PRODUCTS. NATIONAL MAKES NO REPRESENTATIONS OR WARRANTIES WITH RESPECT TO THE ACCURACY OR COMPLETENESS OF THE CONTENTS OF THIS PUBLICATION AND RESERVES THE RIGHT TO MAKE CHANGES TO SPECIFICATIONS AND PRODUCT DESCRIPTIONS AT ANY TIME WITHOUT NOTICE. NO LICENSE, WHETHER EXPRESS, IMPLIED, ARISING BY ESTOPPEL OR OTHERWISE, TO ANY INTELLECTUAL PROPERTY RIGHTS IS GRANTED BY THIS DOCUMENT.

TESTING AND OTHER QUALITY CONTROLS ARE USED TO THE EXTENT NATIONAL DEEMS NECESSARY TO SUPPORT NATIONAL'S PRODUCT WARRANTY. EXCEPT WHERE MANDATED BY GOVERNMENT REQUIREMENTS, TESTING OF ALL PARAMETERS OF EACH PRODUCT IS NOT NECESSARILY PERFORMED. NATIONAL ASSUMES NO LIABILITY FOR APPLICATIONS ASSISTANCE OR BUYER PRODUCT DESIGN. BUYERS ARE RESPONSIBLE FOR THEIR PRODUCTS AND APPLICATIONS USING NATIONAL COMPONENTS. PRIOR TO USING OR DISTRIBUTING ANY PRODUCTS THAT INCLUDE NATIONAL COMPONENTS, BUYERS SHOULD PROVIDE ADEQUATE DESIGN, TESTING AND OPERATING SAFEGUARDS.

EXCEPT AS PROVIDED IN NATIONAL'S TERMS AND CONDITIONS OF SALE FOR SUCH PRODUCTS, NATIONAL ASSUMES NO LIABILITY WHATSOEVER, AND NATIONAL DISCLAIMS ANY EXPRESS OR IMPLIED WARRANTY RELATING TO THE SALE AND/OR USE OF NATIONAL PRODUCTS INCLUDING LIABILITY OR WARRANTIES RELATING TO FITNESS FOR A PARTICULAR PURPOSE, MERCHANTABILITY, OR INFRINGEMENT OF ANY PATENT, COPYRIGHT OR OTHER INTELLECTUAL PROPERTY RIGHT.

LIFE SUPPORT POLICY

NATIONAL'S PRODUCTS ARE NOT AUTHORIZED FOR USE AS CRITICAL COMPONENTS IN LIFE SUPPORT DEVICES OR SYSTEMS WITHOUT THE EXPRESS PRIOR WRITTEN APPROVAL OF THE CHIEF EXECUTIVE OFFICER AND GENERAL COUNSEL OF NATIONAL SEMICONDUCTOR CORPORATION. As used herein:

Life support devices or systems are devices which (a) are intended for surgical implant into the body, or (b) support or sustain life and whose failure to perform when properly used in accordance with instructions for use provided in the labeling can be reasonably expected to result in a significant injury to the user. A critical component is any component in a life support device or system whose failure to perform can be reasonably expected to cause the failure of the life support device or system or to affect its safety or effectiveness.

National Semiconductor and the National Semiconductor logo are registered trademarks of National Semiconductor Corporation. All other brand or product names may be trademarks or registered trademarks of their respective holders.

Copyright© 2009 National Semiconductor Corporation

For the most current product information visit us at www.national.com



National Semiconductor Americas Technical Support Center
 Email: support@nsc.com
 Tel: 1-800-272-9959

National Semiconductor Europe Technical Support Center
 Email: europe.support@nsc.com
 German Tel: +49 (0) 180 5010 771
 English Tel: +44 (0) 870 850 4288

National Semiconductor Asia Pacific Technical Support Center
 Email: ap.support@nsc.com

National Semiconductor Japan Technical Support Center
 Email: jpn.feedback@nsc.com