

# 5th-Order, Lowpass, Elliptic, Switched-Capacitor Filters

## General Description

The MAX7408/MAX7411/MAX7412/MAX7415 5th-order, lowpass, elliptic, switched-capacitor filters (SCFs) operate from a single +5V (MAX7408/MAX7411) or +3V (MAX7412/MAX7415) supply. The devices draw only 1.2mA of supply current and allow corner frequencies from 1Hz to 15kHz, making them ideal for low-power post-DAC filtering and anti-aliasing applications. They can be put into a low-power mode, reducing supply current to 0.2 $\mu$ A.

Two clocking options are available: self-clocking (through the use of an external capacitor) or external clocking for tighter cutoff-frequency control. An offset-adjust pin allows for adjustment of the DC output level.

The MAX7408/MAX7412 deliver 53dB of stopband rejection and a sharp rolloff with a transition ratio of 1.6. The MAX7411/MAX7415 achieve a sharper rolloff with a transition ratio of 1.25 while still providing 37dB of stopband rejection. Their fixed response limits the design task to selecting a clock frequency.

## Applications

ADC Anti-Aliasing                      CT2 Base Stations  
Post-DAC Filtering                      Speech Processing

## Selector Guide

| PART    | TRANSITION RATIO | OPERATING VOLTAGE (V) |
|---------|------------------|-----------------------|
| MAX7408 | r = 1.6          | +5                    |
| MAX7411 | r = 1.25         | +5                    |
| MAX7412 | r = 1.6          | +3                    |
| MAX7415 | r = 1.25         | +3                    |

## Typical Operating Circuit

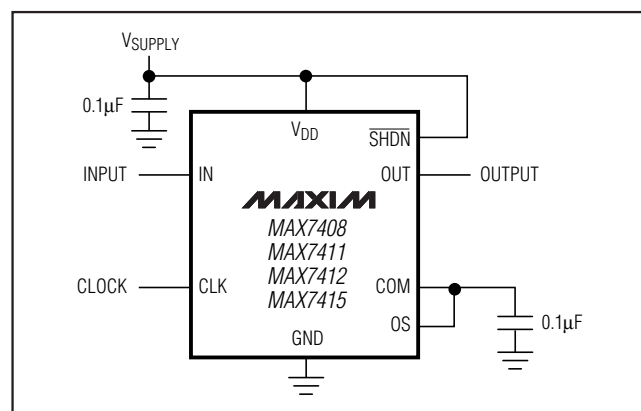

## Features

- ◆ 5th-Order, Elliptic Lowpass Filters
- ◆ Low Noise and Distortion: -80dB THD + Noise
- ◆ Clock-Tunable Corner Frequency (1Hz to 15kHz)
- ◆ Single-Supply Operation
  - +5V (MAX7408/MAX7411)
  - +3V (MAX7412/MAX7415)
- ◆ Low Power
  - 1.2mA (operating mode)
  - 0.2 $\mu$ A (shutdown mode)
- ◆ Available in 8-Pin  $\mu$ MAX/DIP Packages
- ◆ Low Output Offset:  $\pm$ 4mV

## Ordering Information

| PART       | TEMP. RANGE    | PIN-PACKAGE   |
|------------|----------------|---------------|
| MAX7408CPA | 0°C to +70°C   | 8 Plastic DIP |
| MAX7408CUA | 0°C to +70°C   | 8 $\mu$ MAX   |
| MAX7408EPA | -40°C to +85°C | 8 Plastic DIP |
| MAX7408EUA | -40°C to +85°C | 8 $\mu$ MAX   |
| MAX7411CPA | 0°C to +70°C   | 8 Plastic DIP |
| MAX7411CUA | 0°C to +70°C   | 8 $\mu$ MAX   |
| MAX7411EPA | -40°C to +85°C | 8 Plastic DIP |
| MAX7411EUA | -40°C to +85°C | 8 $\mu$ MAX   |
| MAX7412CPA | 0°C to +70°C   | 8 Plastic DIP |
| MAX7412CUA | 0°C to +70°C   | 8 $\mu$ MAX   |
| MAX7412EPA | -40°C to +85°C | 8 Plastic DIP |
| MAX7412EUA | -40°C to +85°C | 8 $\mu$ MAX   |
| MAX7415CPA | 0°C to +70°C   | 8 Plastic DIP |
| MAX7415CUA | 0°C to +70°C   | 8 $\mu$ MAX   |
| MAX7415EPA | -40°C to +85°C | 8 Plastic DIP |
| MAX7415EUA | -40°C to +85°C | 8 $\mu$ MAX   |

## Pin Configuration



# 5th-Order, Lowpass, Elliptic, Switched-Capacitor Filters

## ABSOLUTE MAXIMUM RATINGS

|   |                                   |
|---|-----------------------------------|
| V <sub>DD</sub> to GND                                | -0.3V to +6V                      |
| IN, OUT, COM, OS, CLK, $\overline{\text{SHDN}}$       | -0.3V to (V <sub>DD</sub> + 0.3V) |
| OUT Short-Circuit Duration                            | 1sec                              |
| Continuous Power Dissipation (T <sub>A</sub> = +70°C) |                                   |
| 8-Pin DIP (derate 6.90mW/°C above +70°C)              | 552mW                             |
| 8-Pin $\mu$ MAX (derate 4.1mW/°C above +70°C)         | 330mW                             |

## Operating Temperature Ranges

|                                     |                 |
|-------------------------------------|-----------------|
| MAX74_ _C_A                         | 0°C to +70°C    |
| MAX74_ _E_A                         | -40°C to +85°C  |
| Storage Temperature Range           | -65°C to +160°C |
| Lead Temperature (soldering, 10sec) | +300°C          |

Stresses beyond those listed under "Absolute Maximum Ratings" may cause permanent damage to the device. These are stress ratings only, and functional operation of the device at these or any other conditions beyond those indicated in the operational sections of the specifications is not implied. Exposure to absolute maximum rating conditions for extended periods may affect device reliability.

## ELECTRICAL CHARACTERISTICS—MAX7408/MAX7411

(V<sub>DD</sub> = +5V; filter output measured at OUT, 10k $\Omega$  || 50pF load to GND at OUT,  $\overline{\text{SHDN}}$  = V<sub>DD</sub>, OS = COM, 0.1 $\mu$ F from COM to GND, f<sub>CLK</sub> = 100kHz, T<sub>A</sub> = T<sub>MIN</sub> to T<sub>MAX</sub>, unless otherwise noted. Typical values are at T<sub>A</sub> = +25°C.)

| PARAMETER                                       | SYMBOL                           | CONDITIONS  | MIN                      | TYP                | MAX                      | UNITS      |
|---|----------------------------------|---|--------------------------|--------------------|--------------------------|------------|
| <b>FILTER</b>                                   |                                  |   |                          |                    |                          |            |
| Corner-Frequency Range                          | f <sub>C</sub>                   | (Note 1)  |                          | 0.001 to 15        |                          | kHz        |
| Clock-to-Corner Ratio                           | f <sub>CLK</sub> /f <sub>C</sub> |   |                          | 100:1              |                          |            |
| Clock-to-Corner Tempco                          |                                  |   |                          | 10                 |                          | ppm/°C     |
| Output Voltage Range                            |                                  |   | 0.25                     |                    | V <sub>DD</sub> - 0.25   | V          |
| Output Offset Voltage                           | V <sub>OFFSET</sub>              | V <sub>IN</sub> = V <sub>COM</sub> = V <sub>DD</sub> / 2                        |                          | ±4                 | ±25                      | mV         |
| DC Insertion Gain with Output Offset Removed    |                                  | V <sub>COM</sub> = V <sub>DD</sub> / 2 (Note 2)                                 | 0                        | 0.2                | 0.4                      | dB         |
| Total Harmonic Distortion plus Noise            | THD+N                            | f <sub>IN</sub> = 200Hz, V <sub>IN</sub> = 4Vp-p, measurement bandwidth = 22kHz |                          | -81                |                          | dB         |
| Offset Voltage Gain                             | A <sub>OS</sub>                  | OS to OUT   |                          | 1                  |                          | V/V        |
| COM Voltage Range                               | V <sub>COM</sub>                 | Input, COM externally driven  | $\frac{V_{DD}}{2} - 0.5$ | $\frac{V_{DD}}{2}$ | $\frac{V_{DD}}{2} + 0.5$ | V          |
|   |                                  | Output, COM internally driven   | $\frac{V_{DD}}{2} - 0.2$ | $\frac{V_{DD}}{2}$ | $\frac{V_{DD}}{2} + 0.2$ |            |
| Input Voltage Range at OS                       | V <sub>OS</sub>                  | Measured with respect to COM  |                          | ±0.1               |                          | V          |
| Input Resistance at COM                         | R <sub>COM</sub>                 |   | 110                      | 180                |                          | k $\Omega$ |
| Clock Feedthrough                               |                                  | T <sub>A</sub> = +25°C  |                          | 5                  |                          | mVp-p      |
| Resistive Output Load Drive                     | R <sub>L</sub>                   |   | 10                       | 1                  |                          | k $\Omega$ |
| Maximum Capacitive Load at OUT                  | C <sub>L</sub>                   |   | 50                       | 500                |                          | pF         |
| Input Leakage Current at COM                    |                                  | $\overline{\text{SHDN}}$ = GND, V <sub>COM</sub> = 0 to V <sub>DD</sub>         |                          | ±0.2               | ±10                      | $\mu$ A    |
| Input Leakage Current at OS                     |                                  | V <sub>OS</sub> = 0 to V <sub>DD</sub>  |                          | ±0.2               | ±10                      | $\mu$ A    |
| <b>CLOCK</b>                                    |                                  |   |                          |                    |                          |            |
| Internal Oscillator Frequency                   | f <sub>OSC</sub>                 | C <sub>OSC</sub> = 1000pF (Note 3)  | 19                       | 27                 | 34                       | kHz        |
| Clock Output Current (Internal Oscillator Mode) | I <sub>CLK</sub>                 |   |                          | ±12                | ±20                      | $\mu$ A    |
| Clock Input High                                | V <sub>IH</sub>                  |   | 4.5                      |                    |                          | V          |
| Clock Input Low                                 | V <sub>IL</sub>                  |   |                          |                    | 0.5                      | V          |

# 5th-Order, Lowpass, Elliptic, Switched-Capacitor Filters

MAX7408/MAX7411/MAX7412/MAX7415

## ELECTRICAL CHARACTERISTICS—MAX7408/MAX7411 (continued)

( $V_{DD} = +5V$ ; filter output measured at OUT,  $10k\Omega \parallel 50pF$  load to GND at OUT,  $\overline{SHDN} = V_{DD}$ , OS = COM,  $0.1\mu F$  from COM to GND,  $f_{CLK} = 100kHz$ ,  $T_A = T_{MIN}$  to  $T_{MAX}$ , unless otherwise noted. Typical values are at  $T_A = +25^\circ C$ .)

| PARAMETER                               | SYMBOL                | CONDITIONS                            | MIN | TYP       | MAX      | UNITS   |
|---|-----------------------|---------------------------------------|-----|-----------|----------|---------|
| <b>POWER REQUIREMENTS</b>               |                       |                                       |     |           |          |         |
| Supply Voltage                          | $V_{DD}$              |                                       | 4.5 |           | 5.5      | V       |
| Supply Current                          | $I_{DD}$              | Operating mode, no load               |     | 1.16      | 1.5      | mA      |
| Shutdown Current                        | $I_{\overline{SHDN}}$ | $\overline{SHDN} = GND$               |     | 0.2       | 1        | $\mu A$ |
| Power-Supply Rejection Ratio            | PSRR                  | Measured at DC                        |     | 70        |          | dB      |
| <b>SHUTDOWN</b>                         |                       |                                       |     |           |          |         |
| $\overline{SHDN}$ Input High            | $V_{SDH}$             |                                       | 4.5 |           |          | V       |
| $\overline{SHDN}$ Input Low             | $V_{SDL}$             |                                       |     |           | 0.5      | V       |
| $\overline{SHDN}$ Input Leakage Current |                       | $V_{\overline{SHDN}} = 0$ to $V_{DD}$ |     | $\pm 0.2$ | $\pm 10$ | $\mu A$ |

## ELECTRICAL CHARACTERISTICS—MAX7412/MAX7415

( $V_{DD} = +3V$ , filter output measured at OUT pin,  $10k\Omega \parallel 50pF$  load to GND at OUT,  $\overline{SHDN} = V_{DD}$ , OS = COM,  $0.1\mu F$  from COM to GND,  $f_{CLK} = 100kHz$ ;  $T_A = T_{MIN}$  to  $T_{MAX}$ , unless otherwise noted. Typical values are at  $T_A = +25^\circ C$ .)

| PARAMETER                                    | SYMBOL        | CONDITIONS  | MIN                      | TYP                | MAX                      | UNITS           |
|--|---------------|---|--------------------------|--------------------|--------------------------|-----------------|
| <b>FILTER CHARACTERISTICS</b>                |               |   |                          |                    |                          |                 |
| Corner-Frequency Range                       | $f_C$         | (Note 1)  |                          | 0.001 to 15        |                          | kHz             |
| Clock-to-Corner Ratio                        | $f_{CLK}/f_C$ |   |                          | 100:1              |                          |                 |
| Clock-to-Corner Tempco                       |               |   |                          | 10                 |                          | ppm/ $^\circ C$ |
| Output Voltage Range                         |               |   | 0.25                     |                    | $V_{DD} - 0.25$          | V               |
| Output Offset Voltage                        | $V_{OFFSET}$  | $V_{IN} = V_{COM} = V_{DD} / 2$                                       |                          | $\pm 4$            | $\pm 25$                 | mV              |
| DC Insertion Gain with Output Offset Removed |               | $V_{COM} = V_{DD} / 2$ (Note 2)                                       | 0                        | 0.2                | 0.4                      | dB              |
| Total Harmonic Distortion plus Noise         | THD+N         | $f_{IN} = 200Hz$ , $V_{IN} = 2.5Vp-p$ , measurement bandwidth = 22kHz |                          | -79                |                          | dB              |
| Offset Voltage Gain                          | $A_{OS}$      | OS to OUT   |                          | 1                  |                          | V/V             |
| COM Voltage Range                            | $V_{COM}$     |   | $\frac{V_{DD}}{2} - 0.1$ | $\frac{V_{DD}}{2}$ | $\frac{V_{DD}}{2} + 0.1$ | V               |
| Input Voltage Range at OS                    | $V_{OS}$      | Measured with respect to COM  |                          | $\pm 0.1$          |                          | V               |
| Input Resistance at COM                      | $R_{COM}$     |   | 110                      | 180                |                          | $k\Omega$       |
| Clock Feedthrough                            |               | $T_A = +25^\circ C$   |                          | 3                  |                          | mV/p-p          |
| Resistance Output Load Drive                 | $R_L$         |   | 10                       | 1                  |                          | $k\Omega$       |
| Maximum Capacitive Load at OUT               | $C_L$         |   | 50                       | 500                |                          | pF              |
| Input Leakage Current at COM                 |               | $\overline{SHDN} = GND$ , $V_{COM} = 0$ to $V_{DD}$                   |                          | $\pm 0.2$          | $\pm 10$                 | $\mu A$         |
| Input Leakage Current at OS                  |               | $V_{OS} = 0$ to $V_{DD}$  |                          | $\pm 0.2$          | $\pm 10$                 | $\mu A$         |

# 5th-Order, Lowpass, Elliptic, Switched-Capacitor Filters

## ELECTRICAL CHARACTERISTICS—MAX7412/MAX7415 (continued)

( $V_{DD} = +3V$ , filter output measured at OUT pin,  $10k\Omega \parallel 50pF$  load to GND at OUT,  $\overline{SHDN} = V_{DD}$ , OS = COM,  $0.1\mu F$  from COM to GND,  $f_{CLK} = 100kHz$ ;  $T_A = T_{MIN}$  to  $T_{MAX}$ , unless otherwise noted. Typical values are at  $T_A = +25^\circ C$ .)

| PARAMETER                                       | SYMBOL                | CONDITIONS                            | MIN | TYP       | MAX      | UNITS   |
|---|-----------------------|---------------------------------------|-----|-----------|----------|---------|
| <b>CLOCK</b>                                    |                       |                                       |     |           |          |         |
| Internal Oscillator Frequency                   | $f_{OSC}$             | $C_{OSC} = 1000pF$ (Note 3)           | 19  | 27        | 34       | kHz     |
| Clock Output Current (Internal Oscillator Mode) | $I_{CLK}$             | $V_{CLK} = 0$ or $3V$                 |     | $\pm 12$  | $\pm 20$ | $\mu A$ |
| Clock Input High                                | $V_{IH}$              |                                       | 2.5 |           |          | V       |
| Clock Input Low                                 | $V_{IL}$              |                                       |     |           | 0.5      | V       |
| <b>POWER REQUIREMENTS</b>                       |                       |                                       |     |           |          |         |
| Supply Voltage                                  | $V_{DD}$              |                                       | 2.7 |           | 3.6      | V       |
| Supply Current                                  | $I_{DD}$              | Operating mode, no load               |     | 1.13      | 1.5      | mA      |
| Shutdown Current                                | $I_{\overline{SHDN}}$ | $\overline{SHDN} = GND$               |     | 0.2       | 1        | $\mu A$ |
| Power-Supply Rejection Ratio                    | PSRR                  | Measured at DC                        |     | 70        |          | dB      |
| <b>SHUTDOWN</b>                                 |                       |                                       |     |           |          |         |
| $\overline{SHDN}$ Input High                    | $V_{SDH}$             |                                       | 2.5 |           |          | V       |
| $\overline{SHDN}$ Input Low                     | $V_{SDL}$             |                                       |     |           | 0.5      | V       |
| $\overline{SHDN}$ Input Leakage Current         |                       | $V_{\overline{SHDN}} = 0$ to $V_{DD}$ |     | $\pm 0.2$ | $\pm 10$ | $\mu A$ |

## ELLIPTIC FILTER ( $r = 1.6$ ) CHARACTERISTICS—MAX7408/MAX7412

( $V_{DD} = +5V$  for MAX7408,  $V_{DD} = +3V$  for MAX7412; filter output measured at OUT;  $10k\Omega \parallel 50pF$  load to GND at OUT;  $\overline{SHDN} = V_{DD}$ ;  $V_{COM} = V_{OS} = V_{DD} / 2$ ;  $f_{CLK} = 100kHz$ ;  $T_A = T_{MIN}$  to  $T_{MAX}$ ; unless otherwise noted. Typical values are at  $T_A = +25^\circ C$ .) (Note 3)

| PARAMETER  | CONDITIONS         | MIN  | TYP   | MAX | UNITS |
|--|--------------------|------|-------|-----|-------|
| Insertion Gain with DC Gain Error Removed (Note 4) | $f_{IN} = 0.34f_C$ | -0.4 | -0.2  | 0.4 | dB    |
|  | $f_{IN} = 0.63f_C$ | -0.4 | 0.2   | 0.4 |       |
|  | $f_{IN} = 0.84f_C$ | -0.4 | -0.2  | 0.4 |       |
|  | $f_{IN} = 0.96f_C$ | -0.4 | 0.2   | 0.4 |       |
|  | $f_{IN} = f_C$     | -0.7 | -0.2  | 0.2 |       |
|  | $f_{IN} = 1.60f_C$ |      | -53.4 | -50 |       |
|  | $f_{IN} = 1.90f_C$ |      | -53.4 | -50 |       |
|  | $f_{IN} = 4.62f_C$ |      | -53.4 | -50 |       |

# 5th-Order, Lowpass, Elliptic, Switched-Capacitor Filters

MAX7408/MAX7411/MAX7412/MAX7415

## ELLIPTIC FILTER ( $r = 1.25$ ) CHARACTERISTICS—MAX7411/MAX7415

( $V_{DD} = +5V$  for MAX7411,  $V_{DD} = +3V$  for MAX7415; filter output measured at OUT;  $10k\Omega \parallel 50pF$  load to GND at OUT;  $\overline{SHDN} = V_{DD}$ ,  $V_{COM} = V_{OS} = V_{DD} / 2$ ;  $f_{CLK} = 100kHz$ ;  $T_A = T_{MIN}$  to  $T_{MAX}$ ; unless otherwise noted. Typical values are at  $T_A = +25^\circ C$ .) (Note 3)

| PARAMETER  | CONDITIONS         | MIN  | TYP   | MAX | UNITS |
|--|--------------------|------|-------|-----|-------|
| Insertion Gain with DC Gain Error Removed (Note 4) | $f_{IN} = 0.38f_C$ | -0.4 | -0.2  | 0.4 | dB    |
|  | $f_{IN} = 0.68f_C$ | -0.4 | 0.2   | 0.4 |       |
|  | $f_{IN} = 0.87f_C$ | -0.4 | -0.2  | 0.4 |       |
|  | $f_{IN} = 0.97f_C$ | -0.4 | 0.2   | 0.4 |       |
|  | $f_{IN} = f_C$     | -0.7 | -0.2  | 0.2 |       |
|  | $f_{IN} = 1.25f_C$ |      | -38.5 | -34 |       |
|  | $f_{IN} = 1.43f_C$ |      | -37.2 | -35 |       |
|  | $f_{IN} = 3.25f_C$ |      | -37.2 | -35 |       |

**Note 1:** The maximum  $f_C$  is defined as the clock frequency  $f_{CLK} = 100 \cdot f_C$  at which the peak SINAD drops to 68dB with a sinusoidal input at  $0.2f_C$ .

**Note 2:** DC insertion gain is defined as  $\Delta V_{OUT} / \Delta V_{IN}$ .

**Note 3:**  $f_{OSC}$  (kHz)  $\approx 27 \cdot 10^3 / C_{OSC}$  ( $C_{OSC}$  in pF).

**Note 4:** The input frequencies,  $f_{IN}$ , are selected at the peaks and troughs of the ideal elliptic frequency responses.

## Typical Operating Characteristics

( $V_{DD} = +5V$  for MAX7408/MAX7411,  $V_{DD} = +3V$  for MAX7412/MAX7415;  $f_{CLK} = 100kHz$ ;  $\overline{SHDN} = V_{DD}$ ;  $V_{COM} = V_{OS} = V_{DD} / 2$ ;  $T_A = +25^\circ C$ ; unless otherwise noted.)



# 5th-Order, Lowpass, Elliptic, Switched-Capacitor Filters

## Typical Operating Characteristics (continued)

( $V_{DD} = +5V$  for MAX7408/MAX7411,  $V_{DD} = +3V$  for MAX7412/MAX7415;  $f_{CLK} = 100kHz$ ;  $\overline{SHDN} = V_{DD}$ ;  $V_{COM} = V_{OS} = V_{DD} / 2$ ;  $T_A = +25^\circ C$ ; unless otherwise noted.)

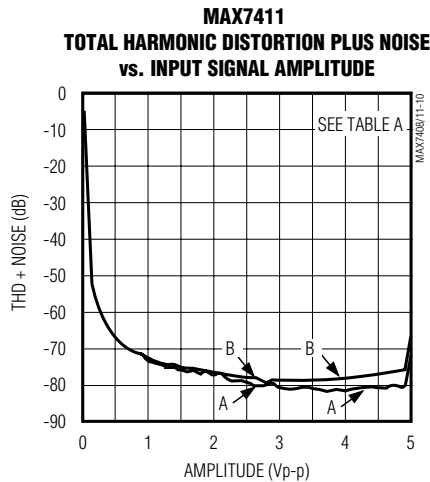
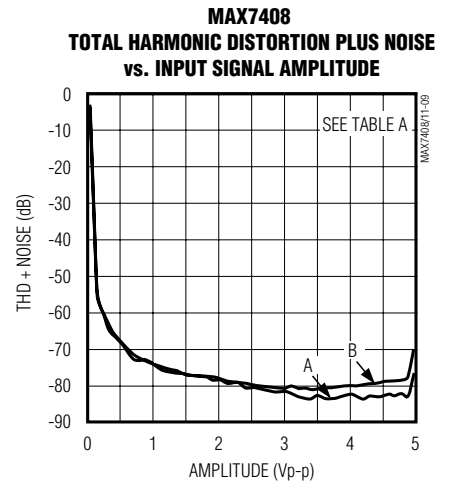
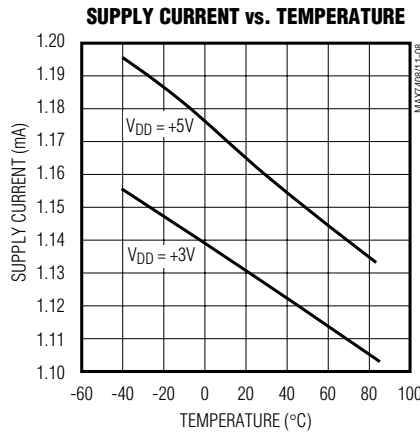
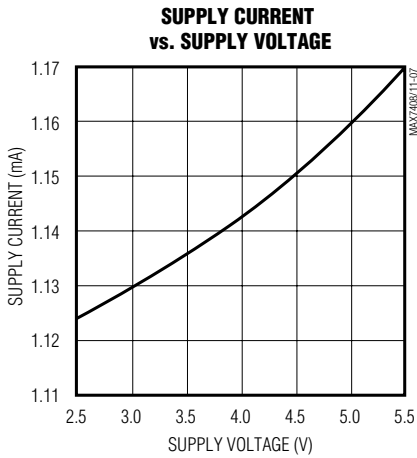
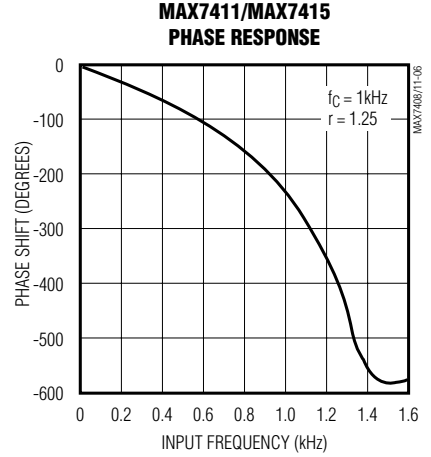
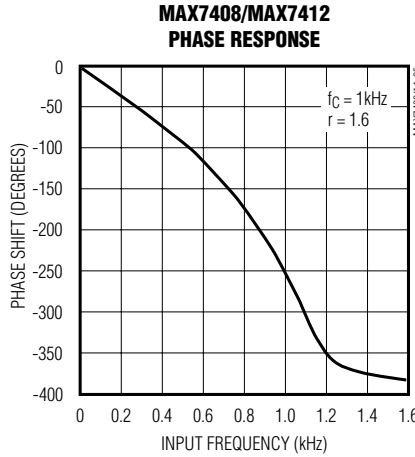
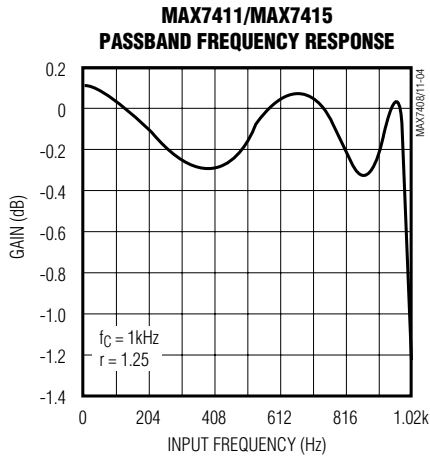

**Table A. THD + Noise Test Conditions**

| LABEL | $f_{IN}$ (Hz) | $f_C$ (kHz) | $f_{CLK}$ (kHz) | MEASUREMENT BANDWIDTH (kHz) |
|-------|---------------|-------------|-----------------|-----------------------------|
| A     | 200           | 1           | 100             | 22                          |
| B     | 1k            | 5           | 500             | 80                          |

# 5th-Order, Lowpass, Elliptic, Switched-Capacitor

## Typical Operating Characteristics (continued)

( $V_{DD} = +5V$  for MAX7408/MAX7411,  $V_{DD} = +3V$  for MAX7412/MAX7415;  $f_{CLK} = 100kHz$ ;  $\overline{SHDN} = V_{DD}$ ;  $V_{COM} = V_{OS} = V_{DD} / 2$ ;  $T_A = +25^\circ C$ ; unless otherwise noted.)

MAX7408/MAX7411/MAX7412/MAX7415



# 5th-Order, Lowpass, Elliptic, Switched-Capacitor Filters

## Pin Description

| PIN | NAME                     | FUNCTION  |
|-----|--------------------------|---|
| 1   | COM                      | Common Input Pin. Biased internally at mid-supply. Bypass externally to GND with 0.1 $\mu$ F capacitor. To override internal biasing, drive with an external supply.                        |
| 2   | IN                       | Filter Input  |
| 3   | GND                      | Ground  |
| 4   | V <sub>DD</sub>          | Positive Supply Input, +5V for MAX7408/MAX7411 or +3V for MAX7412/MAX7415   |
| 5   | OUT                      | Filter Output   |
| 6   | OS                       | Offset Adjust Input. To adjust output offset, bias OS with a resistive voltage-divider between an external supply and ground. Connect OS to COM if no offset adjustment is needed.          |
| 7   | $\overline{\text{SHDN}}$ | Shutdown Input. Drive low to enable shutdown mode; drive high or connect to V <sub>DD</sub> for normal operation.   |
| 8   | CLK                      | Clock Input. Connect an external capacitor (C <sub>OSC</sub> ) from CLK to GND to set the internal oscillator frequency. To override the internal oscillator, connect to an external clock. |

## Detailed Description

The MAX7408/MAX7411/MAX7412/MAX7415 family of 5th-order, elliptic, lowpass filters provides sharp rolloff with good stopband rejection. All parts operate with a 100:1 clock-to-corner frequency ratio and a 15kHz maximum corner frequency.

Most switched-capacitor filters (SCFs) are designed with biquadratic sections. Each section implements two pole-zero pairs, and the sections can be cascaded to produce higher order filters. The advantage to this approach is ease of design. However, this type of design is highly sensitive to component variations if any section's Q is high. The MAX7408/MAX7411/MAX7412/MAX7415 use an alternative approach, which is to emulate a passive network using switched-capacitor integrators with summing and scaling. The passive network may be synthesized using CAD programs, or may be found in many filter books. Figure 1 shows a basic 5th-order ladder elliptic filter structure.

A switched-capacitor filter that emulates a passive ladder filter retains many of the same advantages. The component sensitivity of a passive ladder filter is low when compared to a cascaded biquadratic design,

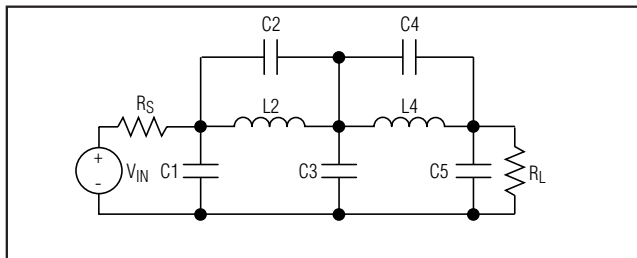

Figure 1. 5th-Order Ladder Elliptic Filter Network

because each component affects the entire filter shape rather than a single pole-zero pair. In other words, a mismatched component in a biquadratic design has a concentrated error on its respective poles, while the same mismatch in a ladder filter design spreads its error over all poles.

## Elliptic Characteristics

Lowpass elliptic filters such as the MAX7408/MAX7411/MAX7412/MAX7415 provide the steepest possible rolloff with frequency of the four most common filter types (Butterworth, Bessel, Chebyshev, and elliptic). The high Q value of the poles near the passband edge combined with the stopband zeros allows for the sharp attenuation characteristic of elliptic filters, making these devices ideal for anti-aliasing and post-DAC filtering in single-supply systems (see the *Anti-Aliasing and Post-DAC Filtering* section).

In the frequency domain, the first transmission zero causes the filter's amplitude to drop to a minimum level. Beyond this zero, the response rises as the frequency increases until the next transmission zero. The stopband begins at the stopband frequency,  $f_s$ . At frequencies above  $f_s$ , the filter's gain does not exceed the gain at  $f_s$ . The corner frequency,  $f_c$ , is defined as the point where the filter output attenuation falls just below the passband ripple. The transition ratio ( $r$ ) is defined as the ratio of the stopband frequency to the corner frequency:

$$r = f_s / f_c$$

The MAX7408/MAX7412 have a transition ratio of 1.6 and typically 53dB of stopband rejection. The MAX7411/MAX7415 have a transition ratio of 1.25 (providing a steeper rolloff) and typically 37dB of stopband rejection.



# 5th-Order, Lowpass, Elliptic, Switched-Capacitor Filters

MAX7408/MAX7411/MAX7412/MAX7415



Figure 2. Elliptic Filter Response

## Clock Signal

### External Clock

These SCFs are designed for use with external clocks that have a 40% to 60% duty cycle. When using an external clock, drive the CLK pin with a CMOS gate powered from 0 to V<sub>DD</sub>. Varying the rate of the external clock adjusts the corner frequency of the filter:

$$f_c = \frac{f_{CLK}}{100}$$

### Internal Clock

When using the internal oscillator, the capacitance (C<sub>OSC</sub>) on CLK determines the oscillator frequency:

$$f_{OSC}(kHz) = \frac{k}{C_{OSC}(pF)}$$

Since C<sub>OSC</sub> is in the low picofarads, minimize the stray capacitance at CLK so that it does not affect the internal oscillator frequency. Varying the rate of the internal oscillator adjusts the filter's corner frequency by a 100:1 clock-to-corner frequency ratio. For example, an internal oscillator frequency of 100kHz produces a nominal corner frequency of 1kHz.

### Input Impedance vs. Clock Frequencies

The MAX7408/MAX7411/MAX7412/MAX7415's input impedance is effectively that of a switched-capacitor resistor (see the following equation), and is inversely proportional to frequency. The input impedance values determined by the equation represent the average input impedance, since the input current is not continuous. As a rule, use a driver with an output resistance less than 10% of the filter's input impedance.



Figure 3. Offset Adjustment Circuit

Estimate the input impedance of the filter by using the following formula:

$$Z_{IN} = \frac{1}{(f_{CLK} \times C_{IN})}$$

where  $f_{CLK}$  = clock frequency and  $C_{IN}$  = 1pF.

### Low-Power Shutdown Mode

The MAX7408/MAX7411/MAX7412/MAX7415 have a shutdown mode that is activated by driving  $\overline{SHDN}$  low. In shutdown mode, the filter supply current reduces to 0.2µA, and the output of the filter becomes high impedance. For normal operation, drive  $\overline{SHDN}$  high or connect to V<sub>DD</sub>.

## Applications Information

### Offset (OS) and Common-Mode (COM) Input Adjustment

COM sets the common-mode input voltage and is biased at mid-supply with an internal resistor-divider. If the application does not require offset adjustment, connect OS to COM. For applications where offset adjustment is required, apply an external bias voltage through a resistor-divider network to OS, as shown in Figure 3. For applications that require DC level shifting, adjust OS with respect to COM. (Note: Do not leave OS unconnected.) The output voltage is represented by these equations:

$$V_{OUT} = (V_{IN} - V_{COM}) + V_{OS}$$

$$V_{COM} = \frac{V_{DD}}{2} \text{ (typical)}$$

where  $(V_{IN} - V_{COM})$  is lowpass filtered by the SCF and OS is added at the output stage. See the *Electrical*

# 5th-Order, Lowpass, Elliptic, Switched-Capacitor Filters

Characteristics table for the input voltage range of COM and OS. Changing the voltage on COM or OS significantly from mid-supply reduces the dynamic range.

### Power Supplies

The MAX7408/MAX7411 operate from a single +5V supply and the MAX7412/MAX7415 operate from a single +3V supply. Bypass  $V_{DD}$  to GND with a 0.1 $\mu$ F capacitor. If dual supplies are required, connect COM to the system ground and GND to the negative supply. Figure 5 shows an example of dual-supply operation. Single-supply and dual-supply performance are equivalent. For either single-supply or dual-supply operation, drive CLK and SHDN from GND ( $V_-$  in dual supply operation) to  $V_{DD}$ . Use the MAX7408/MAX7411 for  $\pm 2.5$ , and use the MAX7412/MAX7415 for  $\pm 1.5$ V. For  $\pm 5$ V dual-supply applications, see the MAX291/MAX292/MAX295/MAX296 and MAX293/MAX294/MAX297 data sheets.

### Input Signal Amplitude Range

The optimal input signal range is determined by observing the voltage level at which the signal-to-noise plus distortion (SINAD) ratio is maximized for a given corner frequency. The *Typical Operating Characteristics* show the THD+Noise response as the input signal's peak-to-peak amplitude is varied.

### Anti-Aliasing and Post-DAC Filtering

When using the MAX7408/MAX7411/MAX7412/MAX7415 for anti-aliasing or post-DAC filtering, synchronize the DAC (or ADC) and the filter clocks. If the



Figure 5. Dual-Supply Operation

clocks are not synchronized, beat frequencies may alias into the desired passband.

### Harmonic Distortion

Harmonic distortion arises from nonlinearities within the filter. These nonlinearities generate harmonics when a pure sine wave is applied to the filter input. Table 1 lists typical harmonic distortion values with a 10k $\Omega$  load at  $T_A = +25^\circ\text{C}$ .

Table 1. Typical Harmonic Distortion

| FILTER  | f <sub>CLK</sub> (kHz) | f <sub>IN</sub> (Hz) | V <sub>IN</sub> (V <sub>p-p</sub> ) | TYPICAL HARMONIC DISTORTION (dB) |     |     |     |
|---------|------------------------|----------------------|-------------------------------------|----------------------------------|-----|-----|-----|
|         |                        |                      |                                     | 2nd                              | 3rd | 4th | 5th |
| MAX7408 | 500                    | 1k                   | 4                                   | TBD                              | TBD | TBD | TBD |
|         | 100                    | 200                  |                                     | TBD                              | TBD | TBD | TBD |
| MAX7411 | 500                    | 1k                   | 4                                   | TBD                              | TBD | TBD | TBD |
|         | 100                    | 200                  |                                     | TBD                              | TBD | TBD | TBD |
| MAX7412 | 500                    | 1k                   | 2                                   | TBD                              | TBD | TBD | TBD |
|         | 100                    | 200                  |                                     | TBD                              | TBD | TBD | TBD |
| MAX7415 | 500                    | 1k                   | 2                                   | TBD                              | TBD | TBD | TBD |
|         | 100                    | 200                  |                                     | TBD                              | TBD | TBD | TBD |

# 5th-Order, Lowpass, Elliptic, Switched-Capacitor Filters

## Chip Information

TRANSISTOR COUNT: 1457

## Package Information



MAX7408/MAX7411/MAX7412/MAX7415

# 5th-Order, Lowpass, Elliptic, Switched-Capacitor Filters

## Package Information (continued)



|    | INCHES |       | MILLIMETERS |       |
|----|--------|-------|-------------|-------|
|    | MIN    | MAX   | MIN         | MAX   |
| A  | ---    | 0.200 | ---         | 5.08  |
| A1 | 0.015  | ---   | 0.38        | ---   |
| A2 | 0.125  | 0.175 | 3.18        | 4.45  |
| A3 | 0.055  | 0.080 | 1.40        | 2.03  |
| B  | 0.016  | 0.022 | 0.41        | 0.56  |
| B1 | 0.045  | 0.065 | 1.14        | 1.65  |
| C  | 0.008  | 0.012 | 0.20        | 0.30  |
| D1 | 0.005  | 0.080 | 0.13        | 2.03  |
| E  | 0.300  | 0.325 | 7.62        | 8.26  |
| E1 | 0.240  | 0.310 | 6.10        | 7.87  |
| e  | 0.100  | ---   | 2.54        | ---   |
| eA | 0.300  | ---   | 7.62        | ---   |
| eB | ---    | 0.400 | ---         | 10.16 |
| L  | 0.115  | 0.150 | 2.92        | 3.81  |

|   | INCHES |       | MILLIMETERS |       | N  | MS001 |
|---|--------|-------|-------------|-------|----|-------|
|   | MIN    | MAX   | MIN         | MAX   |    |       |
| D | 0.348  | 0.390 | 8.84        | 9.91  | 8  | AB    |
| D | 0.735  | 0.765 | 18.67       | 19.43 | 14 | AC    |
| D | 0.745  | 0.765 | 18.92       | 19.43 | 16 | AA    |
| D | 0.885  | 0.915 | 22.48       | 23.24 | 18 | AD    |
| D | 1.015  | 1.045 | 25.78       | 26.54 | 20 | AE    |
| D | 1.14   | 1.265 | 28.96       | 32.13 | 24 | AF    |
| D | 1.360  | 1.380 | 34.54       | 35.05 | 28 | *5    |

- NOTES:
1. D&E DO NOT INCLUDE MOLD FLASH
  2. MOLD FLASH OR PROTRUSIONS NOT TO EXCEED .15mm (.006")
  3. CONTROLLING DIMENSION: MILLIMETER
  4. MEETS JEDEC MS001-XX AS SHOWN IN ABOVE TABLE
  5. SIMILAR TO JEDEC MO-058AB
  6. N = NUMBER OF PINS



PACKAGE FAMILY OUTLINE: PDIP .300"



21-0043 A

Maxim cannot assume responsibility for use of any circuitry other than circuitry entirely embodied in a Maxim product. No circuit patent licenses are implied. Maxim reserves the right to change the circuitry and specifications without notice at any time.

12 Maxim Integrated Products, 120 San Gabriel Drive, Sunnyvale, CA 94086 408-737-7600