

OBSOLETE:

FOR INFORMATION PURPOSES ONLY

Contact Linear Technology for Potential Replacement

FEATURES

- Low Operating Voltage $\pm 5V$ to $\pm 15V$
- **Supply Current: 500 μA**
- **Zero Supply Current When Shut Down**
- **Outputs Can Be Driven $\pm 30V$**
- Output "Open" When Off (Three-State)
- Output Drive: 10mA
- Pinout Similar to 1488*
- Output of Several Devices Can Be Paralleled

APPLICATIONS

- RS232 Driver
- Micropower Interface
- Level Translator

DESCRIPTION

The LT[®]1030 is an RS232 line driver that operates over a $\pm 5V$ to $\pm 15V$ range on low supply current and can be shut down to zero supply current. Outputs are fully protected from externally applied voltages of $\pm 30V$ by current limiting. Since the output swings to within 200mV of the positive supply and 1V of the negative supply, power supply needs are minimized.

A major advantage of the LT1030 is the high impedance output state when off or powered down, which allows several different drivers on the same bus.

Our RS232 product line includes other high performance devices. The LT1039 is a triple low power driver/receiver with shutdown that can be powered from a 5V supply. The LT1080 is a 5V powered dual driver/receiver with on-chip $\pm 9V$ power generator and shutdown.

 LT, LTC and LT are registered trademarks of Linear Technology Corporation.
 *Check compatibility (some pins may be different).

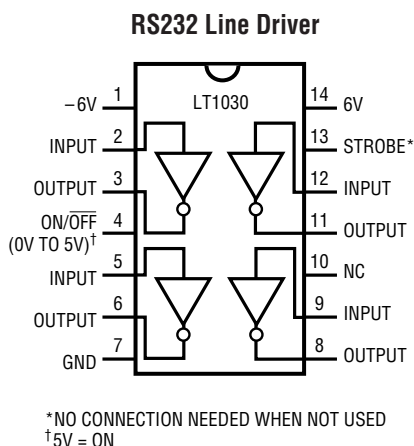
TYPICAL APPLICATION

LT1030 • TA01

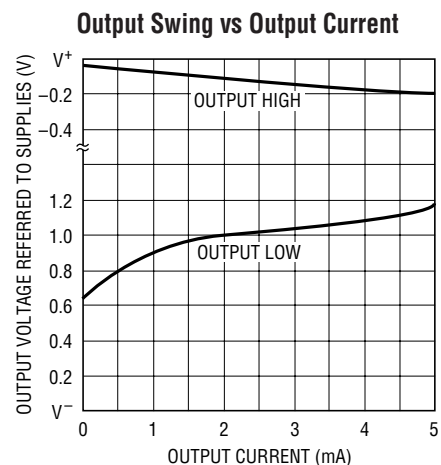

LT1030 • TA02

LT1030

ABSOLUTE MAXIMUM RATINGS

Supply Voltage	$\pm 15V$
Logic Input Pins	V^- to 25V
On/Off Pin	GND to 12V
Output (Forced)	$V^- + 30V, V^+ - 30V$
Short-Circuit Duration (to $\pm 30V$)	Indefinite
Operating Temperature Range	
Commercial	$0^\circ C$ to $70^\circ C$
Guaranteed Functional by Design	$-25^\circ C$ to $85^\circ C$
Storage Temperature	$-65^\circ C$ to $150^\circ C$
Lead Temperature (Soldering, 10 sec)	$300^\circ C$

PACKAGE/ORDER INFORMATION

N PACKAGE
14-LEAD PDIP

S PACKAGE
14-LEAD PLASTIC SO

$T_{JMAX} = 125^\circ C, \theta_{JA} = 90^\circ C/W (N)$
 $T_{JMAX} = 125^\circ C, \theta_{JA} = 95^\circ C/W (S)$

ORDER PART NUMBER

LT1030CN
LT1030CS

LT1030CJ
CONSULT
FACTORY

Consult factory for Industrial and Military grade parts.

ELECTRICAL CHARACTERISTICS (Supply Voltage = ± 5 to $\pm 15V$)

PARAMETER	CONDITIONS	MIN	TYP	MAX	UNITS	
Supply Current	$V_{ON/OFF} \geq 2.4V, I_{OUT} = 0, \text{ All Outputs Low}$	●	500	1000	μA	
Power Supply Leakage Current	$V_{ON/OFF} \leq 0.4V$	●	1	10	μA	
	$V_{ON/OFF} \leq 0.1V$		10	150	μA	
Output Voltage Swing	Load = 2mA	Positive	$V^+ - 0.3V$	$V^+ - 0.1V$	V	
		Negative		$V^- + 0.9V$	$V^- + 1.4V$	V
Output Current	$V_{SUPPLY} \pm 5V \text{ to } \pm 15V$	5	12		mA	
Output Overload Voltage (Forced)	Operating or Shutdown	●	$V^+ - 30V$	$V^- + 30V$	V	
Output Current	Shutdown	$V_S = 0V, V_{OUT} = \pm 30V$		100	μA	
		$V_S = \pm 15V, V_{OUT} = \pm 20V$		100	μA	
Input Overload Voltage (Forced)	Operating or Shutdown	●	V^-	15	V	
Logic Input Levels	Low Input ($V_{OUT} = \text{High}$)	●		1.4	0.8	V
	High Input ($V_{OUT} = \text{Low}$)	●	2	1.4		V
Logic Input Current	$V_{IN} > 2.0V$		2	20	μA	
	$V_{IN} < 0.8V$		10	20	μA	
On/Off Pin Current	$0 \leq V_{IN} \leq 5V$	●	-10	30	μA	
Slew Rate			4	15	$V/\mu S$	

The ● denotes specifications which apply over the full operating temperature range.

Note 1: 3V applied to the Strobe pin will force all outputs low. Strobe pin input impedance is about 2k to ground. Leave open when not used.

PIN FUNCTIONS

V^- (Pin 1): Operates $-15V$ to $-2V$.

LOGIC INPUT (Pins 2, 5, 9, 12): Operate properly on TTL or CMOS levels. Output valid from $(V^- + 2V) \leq V_{IN} \leq 15V$. Connect to 5V when not used.

OUTPUT (Pins 3, 6, 8, 11): Line drive outputs.

ON/OFF (Pin 4): Shuts down entire circuit. Cannot be left open. For "normally on" operation, connect between 5V to 10V.

GND (Pin 7): Ground must be more positive than V^- .

STROBE (Pin 13): Forces all outputs low. Drive with 3V.

V^+ (Pin 14): Positive supply 5V to 15V.

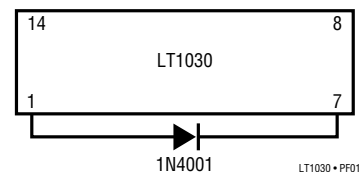

Note: As with other bipolar ICs, forward biasing the substrate diode can cause problems. The LT1030 will draw high current from V^+ to ground if the V^- pin is open circuited or pulled above ground. If this is possible, connecting a diode from V^- to ground will prevent the high current state. Any low cost diode can be used.

TYPICAL PERFORMANCE CHARACTERISTICS

On Supply Current vs Temperature

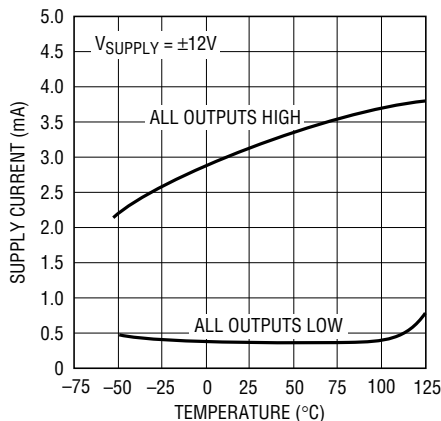

LT1030 • TPC01

On Supply Current vs Supply Voltage

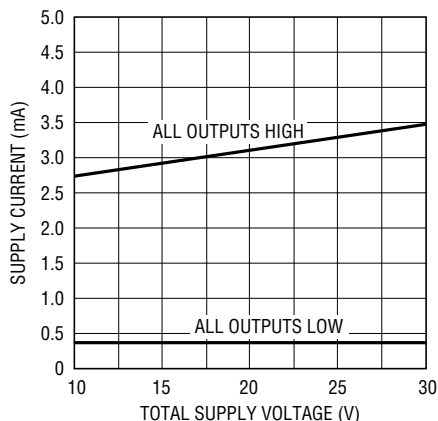

LT1030 • TPC02

Off Supply Current vs Temperature

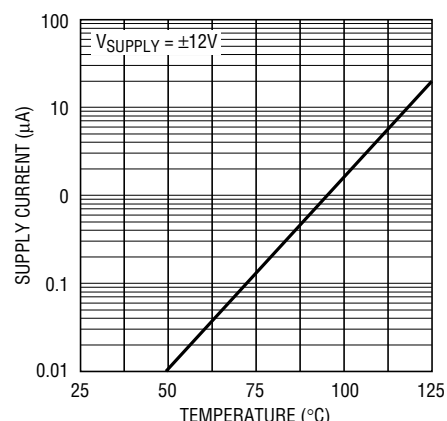

LT1030 • TPC03

Off Output Leakage vs Temperature

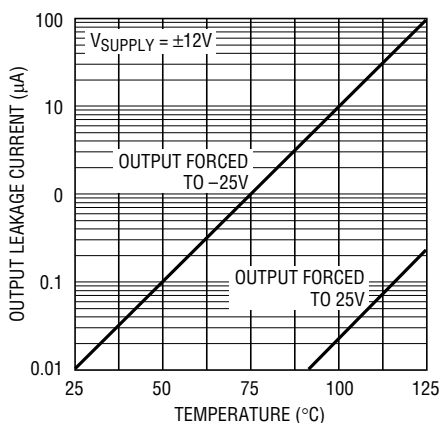

LT1030 • TPC04

On/Off Pin Current vs Voltage

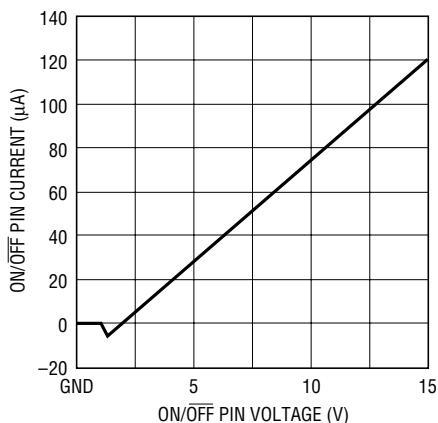

LT1030 • TPC05

Shutdown Voltage vs Temperature

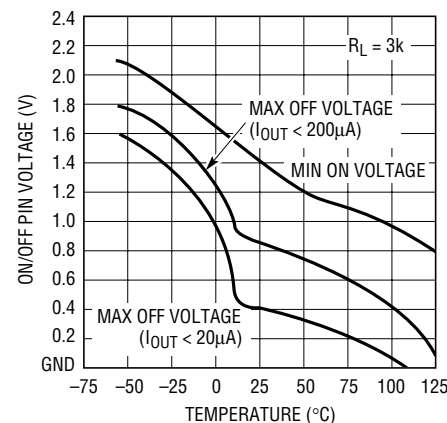

LT1030 • TPC06

Current Limit vs Temperature

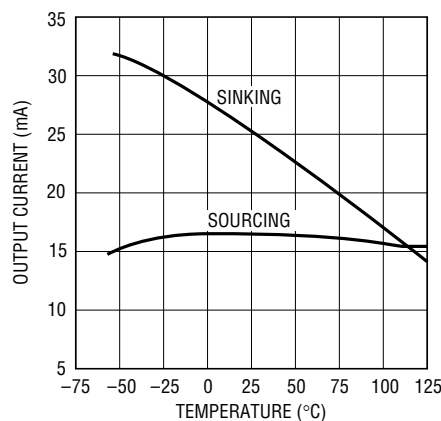

LT1030 • TPC07

Output Swing vs Temperature

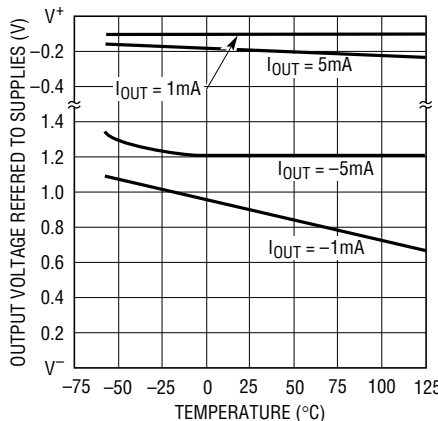

LT1030 • TPC08

Slew Rate vs Temperature

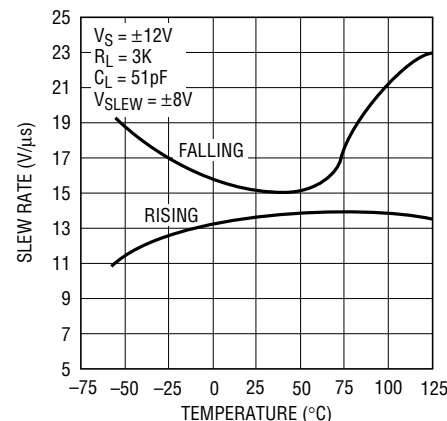

LT1030 • TPC09

TYPICAL PERFORMANCE CHARACTERISTICS

On-Off Response Time

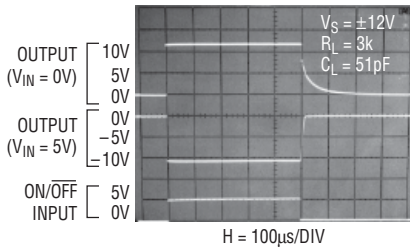

On-Off Response Time

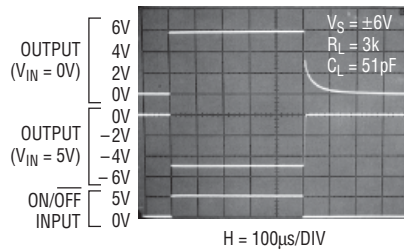

Output Waveforms

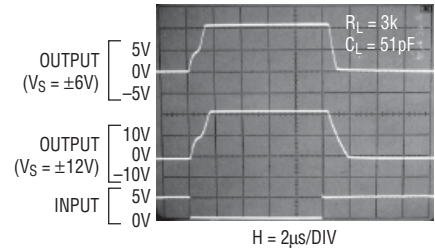

Output Waveform Driving Capacitive Load

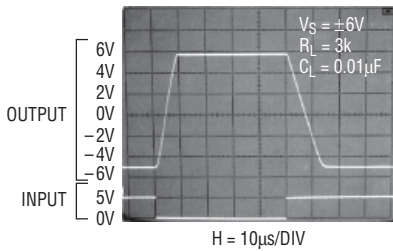

Strobe Pin Response Time

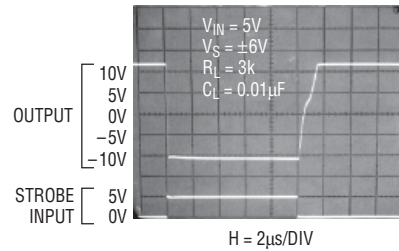

PACKAGE DESCRIPTION

Dimension in inches (millimeters) unless otherwise noted.

N Package
14-Lead Plastic DIP

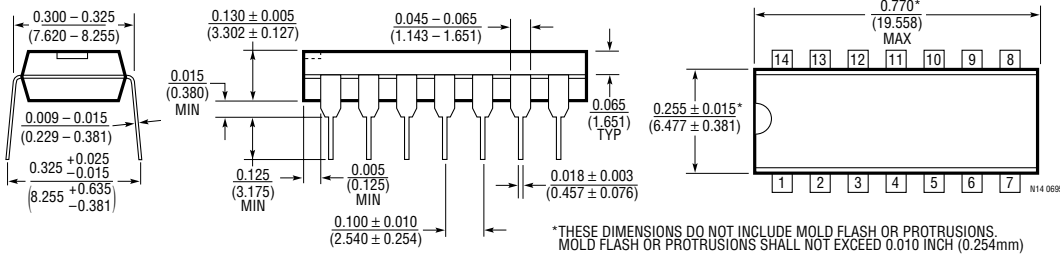

S Package
14-Lead Plastic SO

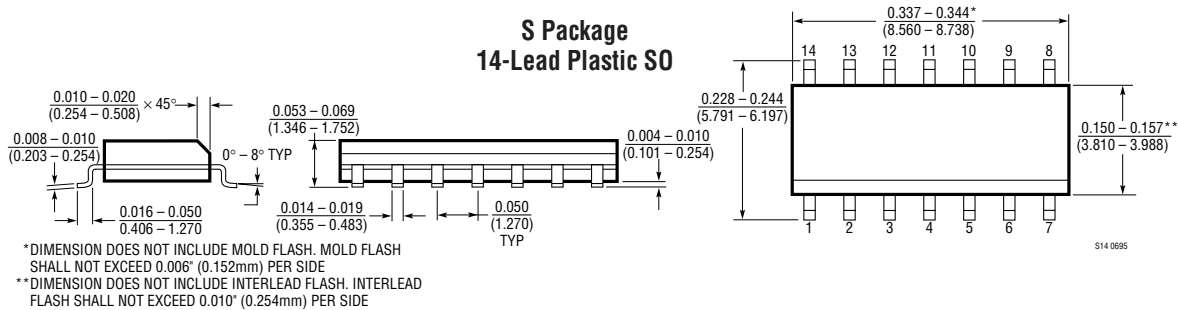

RELATED PARTS

PART NUMBER	DESCRIPTION	COMMENTS
LT1180A	Dual 5V RS232 Transceiver with Shutdown	Shutdown Plus 10kV ESD
LTC®1321	Programmable RS232/RS485 Transceiver	Low Supply Current, High Speed Data Transmission
LT1134A	4-Driver/4-Receiver RS232 Transceiver	Single 5V Supply, 10kV ESD Protection, 0.1µF Charge Pump Capacitor
LTC1383	Micropower Dual 5V RS232 Transceiver	Lowest Power 2-Driver/2-Receiver Solution