



# Programmable DTE/DCE, +5V RS-232 Transceiver

MAX214

## General Description

The MAX214 +5V RS-232 transceiver provides a complete, 8-line, software-configurable, DTE or DCE port RS-232 interface. Tx, Rx, RTS, CTS, DTR, DSR, DCD, and RI circuits can be configured as either Data Terminal Equipment (DTE) or Data Circuit-Terminating Equipment (DCE) using the DTE/DCE control pin. The MAX214 eliminates the need to swap cables when switching between DTE and DCE configurations.

## Applications

- AT-Compatible Laptop Computers
- AT-Compatible Desktop Computers
- Modems, Printers, and Other Peripherals

## Typical Operating Circuit

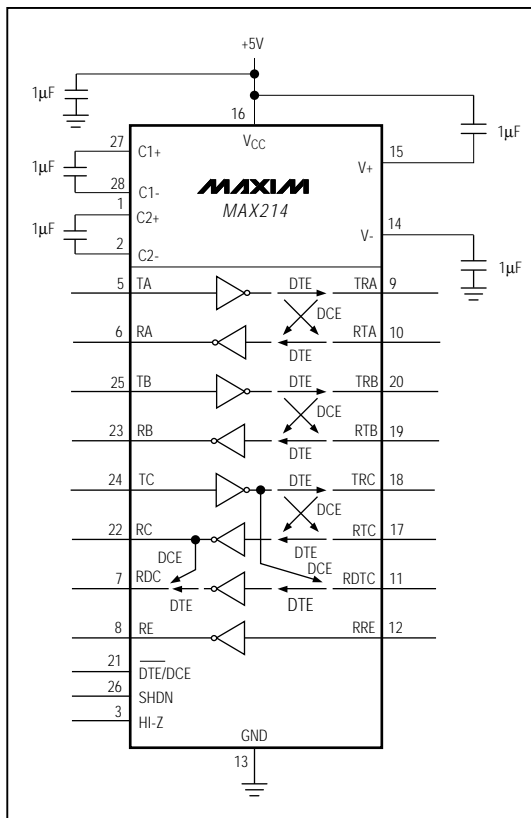

## Features

- ◆ Eliminates Null Modem Cables
- ◆ Programmable DTE or DCE Serial Port
- ◆ 1µF Charge-Pump Capacitors
- ◆ 116kbps Data Rate—Guaranteed
- ◆ 20µA Shutdown Mode
- ◆ Receivers Active in Shutdown

## Ordering Information

PART	TEMP. RANGE	PIN-PACKAGE
MAX214CPI	0°C to +70°C	28 Plastic DIP
MAX214CWI	0°C to +70°C	28 Wide SO
MAX214C/D	0°C to +70°C	Dice*
MAX214EPI	-40°C to +85°C	28 Plastic DIP
MAX214EWI	-40°C to +85°C	28 Wide SO

\* Dice are specified at  $T_A = +25^\circ\text{C}$ .

## Pin Configuration

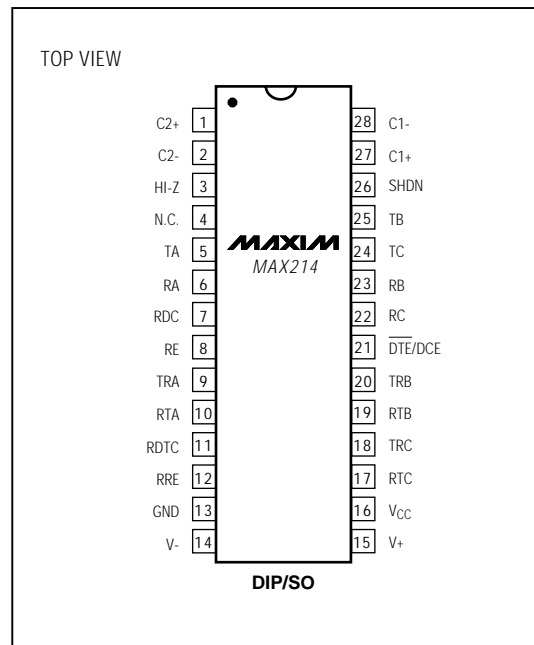

Maxim Integrated Products 1

Call toll free 1-800-998-8800 for free samples or literature.

# Programmable DTE/DCE, +5V RS-232 Transceiver

MAX214

## ABSOLUTE MAXIMUM RATINGS

V <sub>CC</sub> .....	-0.3V to +6V	Continuous Power Dissipation (T <sub>A</sub> = +70°C)	
Input Voltages		Plastic DIP (derate 9.09mW/°C above +70°C) .....	727mW
T <sub>IN</sub> , DTE/DCE, SHDN HI-Z .....	-0.3V to (V <sub>CC</sub> + 0.3V)	Wide SO (derate 12.50mW/°C above +70°C) .....	1000mW
R <sub>IN</sub> .....	±15V	Operating Temperature Ranges:	
Output Voltages:		MAX214C_I .....	0°C to +70°C
T <sub>OUT</sub> .....	±15V	MAX214E_I .....	-40°C to +85°C
R <sub>OUT</sub> .....	-0.3V to (V <sub>CC</sub> + 0.3V)	Storage Temperature Range .....	-65°C to +150°C
Short-Circuit (one output at a time)		Lead Temperature (soldering, 10sec) .....	+300°C
T <sub>OUT</sub> to GND .....	Continuous		
R <sub>OUT</sub> to GND.....	Continuous		

Stresses beyond those listed under "Absolute Maximum Ratings" may cause permanent damage to the device. These are stress ratings only, and functional operation of the device at these or any other conditions beyond those indicated in the operational sections of the specifications is not implied. Exposure to absolute maximum rating conditions for extended periods may affect device reliability.

## ELECTRICAL CHARACTERISTICS

(V<sub>CC</sub> = 4.5V to 5.5V, C1 to C4 = 1μF, T<sub>A</sub> = T<sub>MIN</sub> to T<sub>MAX</sub>, unless otherwise noted.)

PARAMETER	CONDITIONS	MIN	TYP	MAX	UNITS
<b>RS-232 TRANSMITTERS</b>					
Logic Input Threshold Low		0.8	1.4		V
Logic Input Threshold High			1.4	2.0	V
Logic Input Pull-Up Current	Normal operation	1	10	50	μA
	Shutdown		±0.01	±1	
Output Voltage Swing	All transmitter outputs loaded with 3kΩ to ground	±5.0	±7.5		V
Transmitter Output Resistance	V <sub>CC</sub> = V <sub>+</sub> = V <sub>-</sub> = 0V, V <sub>OUT</sub> = ±2V (Note 1)	300	300k		Ω
Output Short-Circuit Current	V <sub>OUT</sub> = 0V	±7	±25		mA
<b>RS-232 RECEIVERS</b>					
Input Voltage Operating Range				±15	V
Positive Threshold Input Low	T <sub>A</sub> = +25°C, V <sub>CC</sub> = 5V, normal operation, SHDN = 0V	0.8	1.3		V
Positive Threshold Input High	T <sub>A</sub> = +25°C, V <sub>CC</sub> = 5V, normal operation, SHDN = 0V		1.8	2.4	V
Positive Threshold Input Hysteresis	V <sub>CC</sub> = 5V, normal operation, SHDN = 0V (no hysteresis in shutdown)	0.2	0.5	1.0	V
Negative Threshold Input Low	T <sub>A</sub> = +25°C, V <sub>CC</sub> = 5V	Normal operation, SHDN = 0V	-2.6	-1.9	V
		Shutdown, SHDN = 5V	0.8	1.3	
Negative Threshold Input High	T <sub>A</sub> = +25°C, V <sub>CC</sub> = 5V	Normal operation, SHDN = 0V		-1.5	V
		Shutdown, SHDN = 5V		1.3	
Negative Threshold Input Hysteresis	V <sub>CC</sub> = 5V, normal operation, SHDN = 0V (no hysteresis in shutdown)	0.2	0.4	1.0	V
Input Resistance	HI-Z = 0V and SHDN = 0V	3	5	7	kΩ
	HI-Z = 5V or SHDN = 5V	100	300		
TTL/CMOS Output Voltage Low	I <sub>OUT</sub> = 3.2mA		0.2	0.4	V
TTL/CMOS Output Voltage High	I <sub>OUT</sub> = -1.0mA	3.5	V <sub>CC</sub> - 0.2		V

# Programmable DTE/DCE, +5V RS-232 Transceiver

MAX214

## ELECTRICAL CHARACTERISTICS (continued)

(V<sub>CC</sub> = 4.5V to 5.5V, C1 to C4 = 1μF, T<sub>A</sub> = T<sub>MIN</sub> to T<sub>MAX</sub>, unless otherwise noted.)

PARAMETER	CONDITIONS	MIN	TYP	MAX	UNITS
<b>POWER SUPPLY</b>					
V <sub>CC</sub> Supply Current	No load, T <sub>A</sub> = +25°C		9	20	mA
Shutdown Supply Current	$\overline{\text{DTE}}/\text{DCE} = 0\text{V}$ , SHDN = HI-Z = V <sub>CC</sub> , Figure 1		T <sub>A</sub> = +25°C		μA
			T <sub>A</sub> = T <sub>MIN</sub> to T <sub>MAX</sub>		
<b>CONTROL LOGIC (<math>\overline{\text{DTE}}/\text{DCE}</math>, SHDN, HI-Z)</b>					
Logic Input Threshold Low		0.8	1.3		V
Logic Input Threshold High			1.3	2.0	V
Input Leakage Current				±1	μA
<b>AC CHARACTERISTICS</b>					
Data Rate	Normal operation, transmitters and receivers		200	116	kbps
	Receivers in shutdown mode		20		
Transition-Region Slew Rate	T <sub>A</sub> = +25°C, V <sub>CC</sub> = 5V, R <sub>L</sub> = 3kΩ to 7kΩ, C <sub>L</sub> = to 2500pF, measured from 3V to -3V or -3V to 3V	6	12	30	V/μs
Transmitter Propagation Delay, TTL to RS-232 (Normal Operation)	t <sub>PHLT</sub>		1.3	3.5	μs
	t <sub>PLHT</sub>		1.4	3.5	
Transmitter + to - Propagation-Delay Difference (Normal Operation)	t <sub>PHLT</sub> - t <sub>PLHT</sub>		100		ns
Receiver Propagation Delay, RS-232 to TTL (Normal Operation)	t <sub>PHLR</sub> , t <sub>PLHR</sub>		0.4	1.5	μs
Receiver Propagation Delay, RS-232 to TTL (Shutdown Mode)	t <sub>PHLR</sub>		0.4	10	μs
	t <sub>PLHR</sub>		1.5	10	
Receiver Propagation-Delay Difference (Normal Operation)	t <sub>PHLT</sub> - t <sub>PLHT</sub>		100		ns
<b>MODE-CHANGE TIMING (DTE/DCE)</b>					
Transmitter Enable Time	t <sub>TEN</sub> (includes charge-pump start-up time)		250		μs
Transmitter Disable Time	t <sub>TTR</sub>		600		ns
Transmitter $\overline{\text{DTE}}/\text{DCE}$ Switch Time	t <sub>TSW</sub>		600		ns
Receiver $\overline{\text{DTE}}/\text{DCE}$ Switch Time	t <sub>RSW</sub>		300		ns
Receiver Termination-Resistor Connect/Disconnect Time	(SHDN = 0V)		300		ns
Receiver Termination-Resistor Connect Entering SHDN Time			250		μs
Receiver Termination-Resistor Disconnect Exiting SHDN Time			300		ns

**Note 1:** The 300Ω minimum is the EIA/TIA-232E specification, but the actual resistance when in shutdown mode or when V<sub>CC</sub> = 0V is typically 300kΩ.

# Programmable DTE/DCE, +5V RS-232 Transceiver

## Typical Operating Characteristics

(V<sub>CC</sub> = 5V, C1 to C4 = 1μF, all transmitters loaded with 3kΩ in parallel with 2.5nF, T<sub>A</sub> = +25°C, unless otherwise noted.)

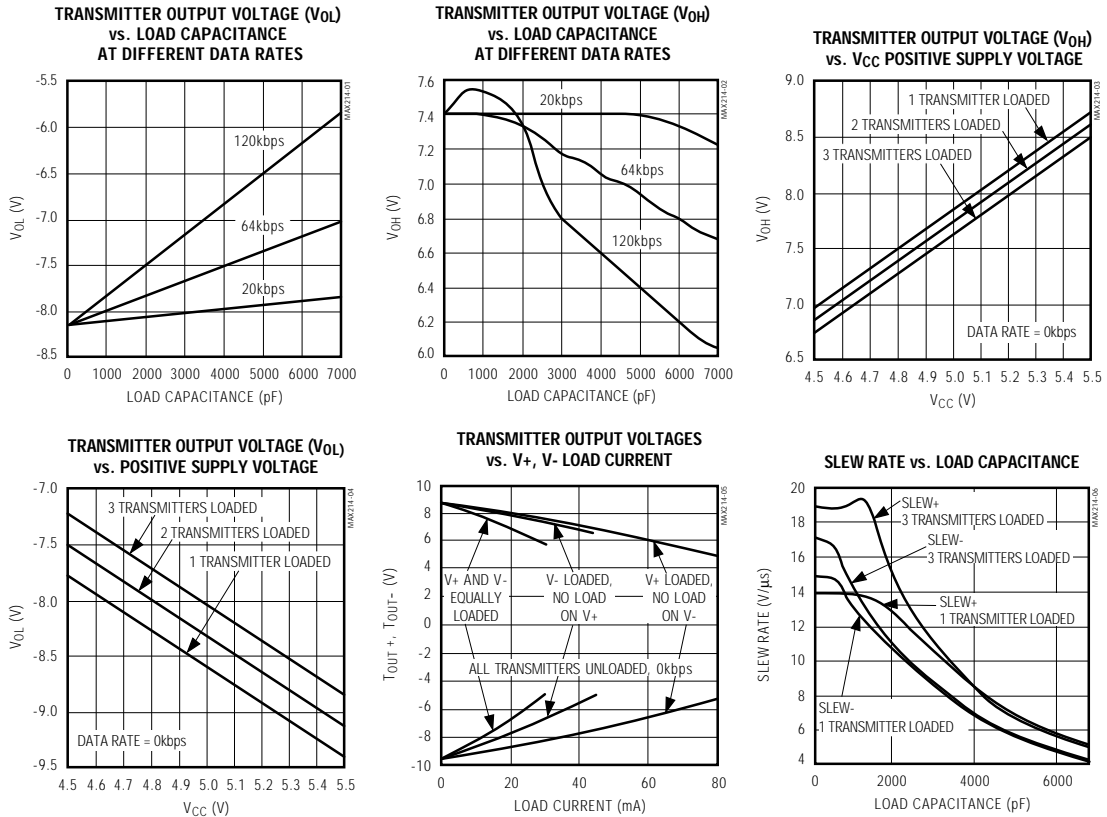

# Programmable DTE/DCE, +5V RS-232 Transceiver

## Pin Description

MAX214

PIN	NAME	FUNCTION
1, 2	C2+, C2-	Terminals for negative charge-pump capacitor
3	HI-Z	RS-232 receiver impedance control. Take high to disconnect the termination resistor.
4	N.C.	No connect—not internally connected
5, 24, 25	TA, TC, TB	TTL/CMOS driver A, C, B inputs
6, 8, 22, 23	RA, RE, RC, RB	TTL/CMOS receiver A, E, C, B outputs
7	RDC	TTL/CMOS DTE receiver output D for $\overline{\text{DTE}}/\text{DCE} = 0\text{V}$ , or TTL/CMOS DCE receiver output C for $\overline{\text{DTE}}/\text{DCE} = +5\text{V}$
9, 18, 20	TRA, TRC, TRB	RS-232 DTE driver output for $\overline{\text{DTE}}/\text{DCE} = 0\text{V}$ , or RS-232 DCE receiver input for $\overline{\text{DTE}}/\text{DCE} = +5\text{V}$
10, 17, 19	RTA, RTC, RTB	RS-232 DTE receiver input for $\overline{\text{DTE}}/\text{DCE} = 0\text{V}$ , or RS-232 DCE driver output for $\overline{\text{DTE}}/\text{DCE} = +5\text{V}$
11	RDC	RS-232 DTE receiver input D for $\overline{\text{DTE}}/\text{DCE} = 0\text{V}$ , or RS-232 DCE driver output C for $\overline{\text{DTE}}/\text{DCE} = +5\text{V}$
12	RRE	RS-232 receiver input
13	GND	Ground
14	V-	-2V <sub>CC</sub> voltage generated by the charge pump
15	V+	+2V <sub>CC</sub> voltage generated by the charge pump
16	V <sub>CC</sub>	+4.5V to +5.5V supply voltage
21	$\overline{\text{DTE}}/\text{DCE}$	Data terminal equipment (DTE) and data circuit-terminating equipment (DCE) control pin. DCE active high and DTE active low.
26	SHDN	Shutdown control; shutdown high, normal operation low
27, 28	C1+, C1-	Terminals for positive charge-pump capacitor

## Detailed Description

The MAX214 RS-232 transceiver provides a complete, 8-line, software-configurable, DTE or DCE port RS-232 interface. Tx, Rx, RTS, CTS, DTR, DSR, DCD, and RI circuits can be configured as either Data Terminal Equipment (DTE) or Data Circuit-Terminating Equipment (DCE) using the  $\overline{\text{DTE}}/\text{DCE}$  control pin. The MAX214 eliminates the need to swap cables when switching between DTE and DCE configurations. This is useful when, for example, a portable computer is required to communicate with printers, modems, and other computers without carrying multiple cables.

The MAX214 runs from a single +5V supply and incorporates a dual charge-pump voltage converter to generate the necessary voltages for the RS-232 transmitters. A shutdown mode is provided to save power when transmission is not required, but the receivers always stay active for simple detection of ring indicator signals.

## $\overline{\text{DTE}}/\text{DCE}$ Operation

The  $\overline{\text{DTE}}/\text{DCE}$  pin allows circuit configuration under software control. Tables 1a and 1b show the pin definitions of the MAX214 in both DTE and DCE modes. The Function columns show the direction of data flow from the input pin to the output pin of the MAX214, and onto the corresponding DB-25 connector's pin.

### +5V to $\pm 10\text{V}$ Dual Charge-Pump Voltage Converter

The +5V to  $\pm 10\text{V}$  conversion is performed by two charge-pump voltage converters (Figure 2). The first uses capacitor C1 to double the +5V to +10V, storing the +10V on the output filter capacitor, C3. The second charge-pump voltage converter uses C2 to invert the +10V to -10V, storing the -10V on the V- output filter capacitor, C4.









In shutdown mode, V+ is pulled to V<sub>CC</sub> by an internal resistor, and V- falls to GND.

# Programmable DTE/DCE, +5V RS-232 Transceiver







MAX214

MAX214

**Table 1a. DTE-Operation Pin Configurations**

TTL/CMOS I/O LABEL	MAX214 PIN	FUNCTION	MAX214 PIN	RS-232 I/O LABEL	DB-25 PIN	INPUT THRESHOLD
Transmitter (TxD)	5		9	TxD	2	
Receiver (RxD)	6		10	RxD	3	+
Request to Send (RTS)	25		20	RTS	4	
Clear to Send (CTS)	23		19	CTS	5	-
Data Terminal Ready (DTR)	24		18	DTR	20	
Data Set Ready (DSR)	22		17	DSR	6	-
Detector Carrier Data (DCD)	7		11	DCD	8	+
Ring Indicator (RI)	8		12	RI	22	+

**Table 1b. DCE-Operation Pin Configurations**

MAX214 PIN	FUNCTION	MAX214 PIN	RS-232 I/O LABEL	DB-25 PIN	INPUT THRESHOLD
5		10	RxD	3	
6		9	TxD	2	+
25		19	CTS	5	
23		20	RTS	4	-
24		17	DSR	6	
		11	DCD	8	
22		18	DTR	20	-
7					
8		12	RI	22	+

# Programmable DTE/DCE, +5V RS-232 Transceiver

MAX214

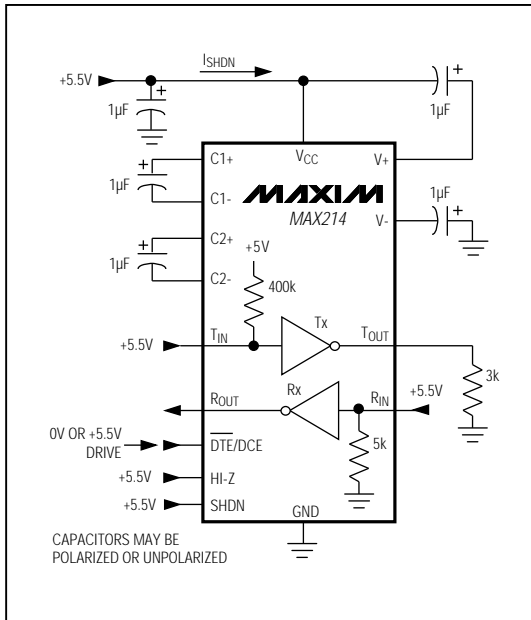

Figure 1. MAX214 Shutdown-Current Test Circuit

**RS-232 Drivers**  
With  $V_{CC} = 5V$ , the typical driver output voltage swing is  $\pm 8V$  when loaded with a nominal  $5k\Omega$  RS-232 receiver. Under worst-case operating conditions (including 116kbps data rate,  $3k\Omega \parallel 2500pF$  load,  $V_{CC} = 4.5V$ , maximum rated temperature) the output swing is guaranteed to meet the  $\pm 5V$  minimum specified by EIA/TIA-232 and V.28. The open-circuit output voltage swing ranges from  $(V_+ - 0.6V)$  to  $V_-$ .

Input thresholds are both CMOS and TTL compatible. The inputs of unused drivers can be left unconnected because  $400k\Omega$  pull-up resistors to  $V_{CC}$  are included on-chip. Since all drivers invert, the pull-up resistors force the outputs of unused drivers low. The input pull-up resistors typically source  $10\mu A$ ; in shutdown mode, they are disconnected to reduce supply current.

When in low-power shutdown mode, the driver outputs are turned off and their leakage current is less than  $1\mu A$ , even if the transmitter output is back-driven with voltages up to  $\pm 15V$ .

**RS-232 Receivers**  
The receivers convert the RS-232 signals to CMOS-logic levels. They invert, to match the inversion of RS-232 drivers. The guaranteed receiver input thresholds are significantly tighter than the  $\pm 3V$  thresholds required by the EIA/TIA-232E specification,

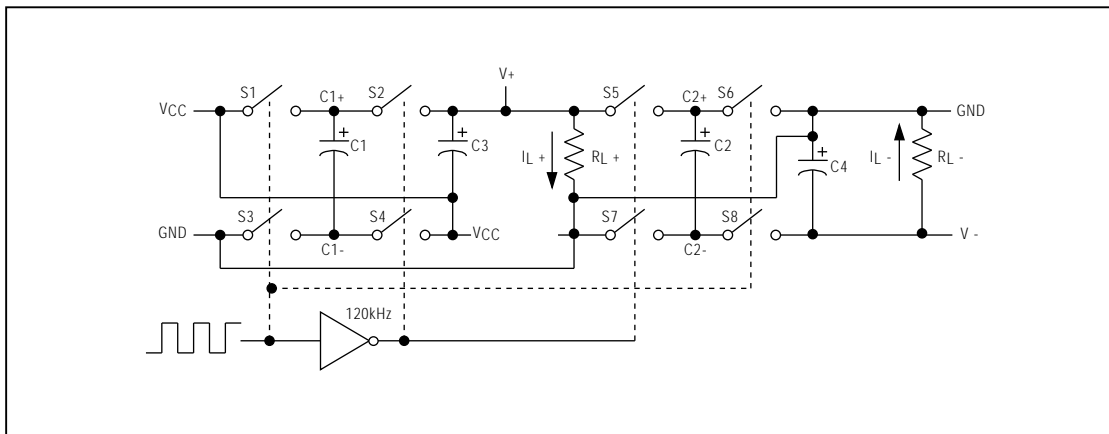

Figure 2. Charge-Pump Diagram

# Programmable DTE/DCE, +5V RS-232 Transceiver

MAX214

**Table 2. Control Pin Configurations**

CONTROL INPUTS			RS-232 PINS		
SHUTDOWN	HI-Z	DTE/DCE	TRA, TRB, TRC	RTA, RTB, RTC, RDTC	RRE
0	0	0	Transmit Mode	Receive Mode/5k $\Omega$	Receive Mode/5k $\Omega$
0	0	1	Receive Mode/5k $\Omega$	Transmit Mode	Receive Mode/5k $\Omega$
0	1	0	Transmit Mode	Receive Mode/HI-Z	Receive Mode/HI-Z
0	1	1	Receive Mode/HI-Z	Transmit Mode	Receive Mode/HI-Z
1	0	0	Disabled/HI-Z	Slow Receive/HI-Z	Slow Receive/HI-Z
1	0	1	Slow Receive/HI-Z	Disabled/HI-Z	Slow Receive/HI-Z
1	1	0	Disabled/HI-Z	Slow Receive/HI-Z	Slow Receive/HI-Z
1	1	1	Slow Receive/HI-Z	Disabled/HI-Z	Slow Receive/HI-Z

which improves noise margins. The polarity of each receiver's input threshold is shown in Tables 1a and 1b. In normal operating mode, receiver inputs are internally connected to ground with 5k $\Omega$  resistors. So unconnected receivers with positive input thresholds have high outputs, and those with negative input thresholds have low outputs.

When shut down, all receivers have positive thresholds. This allows the receiver inputs to respond to TTL-/CMOS-logic levels, as well as RS-232 levels. The guaranteed 0.8V input threshold ensures that receivers shorted to ground will have a logic 1 output. Also, the 300k $\Omega$  input resistance to ground ensures that a receiver with its input left open will also have a logic 1 output.

The receiver's 0.5V of hysteresis provides clean output transitions, even with slow rise-time and fall-time signals with moderate amounts of noise and ringing. The receivers have no hysteresis in shutdown mode.

### HI-Z Control

The receiver inputs are terminated with 5k $\Omega$  resistors, to comply with the requirements of EIA/TIA-232E. However, these internal resistors can be disconnected by taking the HI-Z control pin to a logic high. This makes all of the MAX214's receiver inputs high impedance, and facilitates the transmission of RS-232 data from a single transmitter to multiple receivers. In this case, all but one of the receiving ICs should be put into the high input-impedance state.

### Shutdown Control

In shutdown mode, the charge pumps are turned off, V<sub>+</sub> is pulled down to V<sub>CC</sub>, V<sub>-</sub> is pulled to ground, and the transmitter outputs are disabled. This reduces supply current typically to 4 $\mu$ A. The time required to exit shutdown is about 250 $\mu$ s, as shown in Figure 3.

### Receivers

Receiver outputs never go into a high-impedance state; they are always active, even in shutdown mode (see Table 2). These awake-in-shutdown receivers are useful for monitoring external activity (for example, on RI), while maintaining minimal power consumption. Receivers in shutdown mode are slower (20kbps) than when not shut down (116kbps), and lack the hysteresis present in normal operation.

### Drivers

The driver outputs are high impedance in shutdown mode, even when back-driven with voltages up to  $\pm$ 15V.

## Applications Information

### Capacitor Selection

The type of capacitor (C1 to C4) used is not critical for proper operation. The MAX214 requires 1 $\mu$ F capacitors, although in all cases capacitors of up to 10 $\mu$ F can be used without harm. Ceramic dielectrics are suggested for the 1 $\mu$ F capacitors.



## Programmable DTE/DCE, +5V RS-232 Transceiver

When using the minimum recommended capacitor values, make sure the capacitance value does not degrade excessively as the operating temperature varies. If in doubt, use capacitors with a larger nominal value (for example, 2 times larger). The effective series resistance (ESR) of the capacitors may vary over temperature and increase when below 0°C. ESR influences the amount of ripple on V+ and V-, so if low ripple is required over wide temperature ranges, use larger capacitors or low-ESR types.

To reduce the output impedance at V+ and V-, use larger capacitors (up to 10 $\mu$ F). This can be useful when "stealing" power from V+ or from V-.

### Driver Outputs when Exiting Shutdown

Figure 3 shows the MAX214 driver outputs when exiting shutdown. As they become active, the two driver outputs are shown going to opposite RS-232 levels (one driver input is high, the other is low). Each driver is loaded with 3k $\Omega$  in parallel with 2.5nF.

### Power-Supply Bypassing

Decouple VCC to ground with a capacitor of the same value as the charge-pump capacitors.

### V+ and V- as Power Supplies

A small amount of power can be drawn from V+ and V-, although this will reduce noise margins. See the Output Voltage vs. Load Current graph in the *Typical Operating Characteristics*. Increasing the charge-

pump capacitor sizes up to 10 $\mu$ F reduces the impedance of the V+ and V- outputs.

### High Data Rates

The MAX214 maintains the RS-232  $\pm 5.0$ V minimum driver output voltage even at high data rates. The *Typical Operating Characteristics* show transmitter output voltage levels driving 3k $\Omega$  in parallel with various capacitive loads at data rates up to 120kbps.

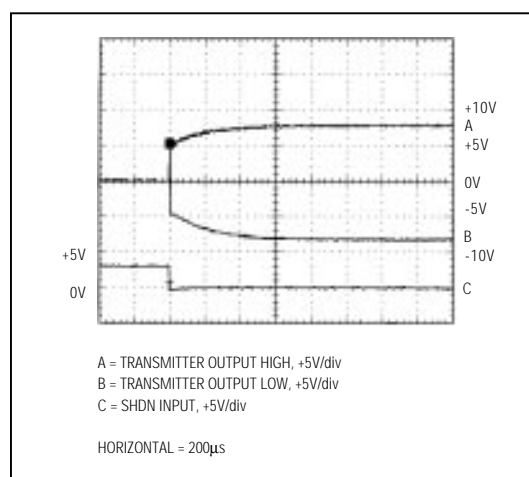

Figure 3. Transmitter Outputs When Exiting Shutdown

# Programmable DTE/DCE, +5V RS-232 Transceiver

MAX214

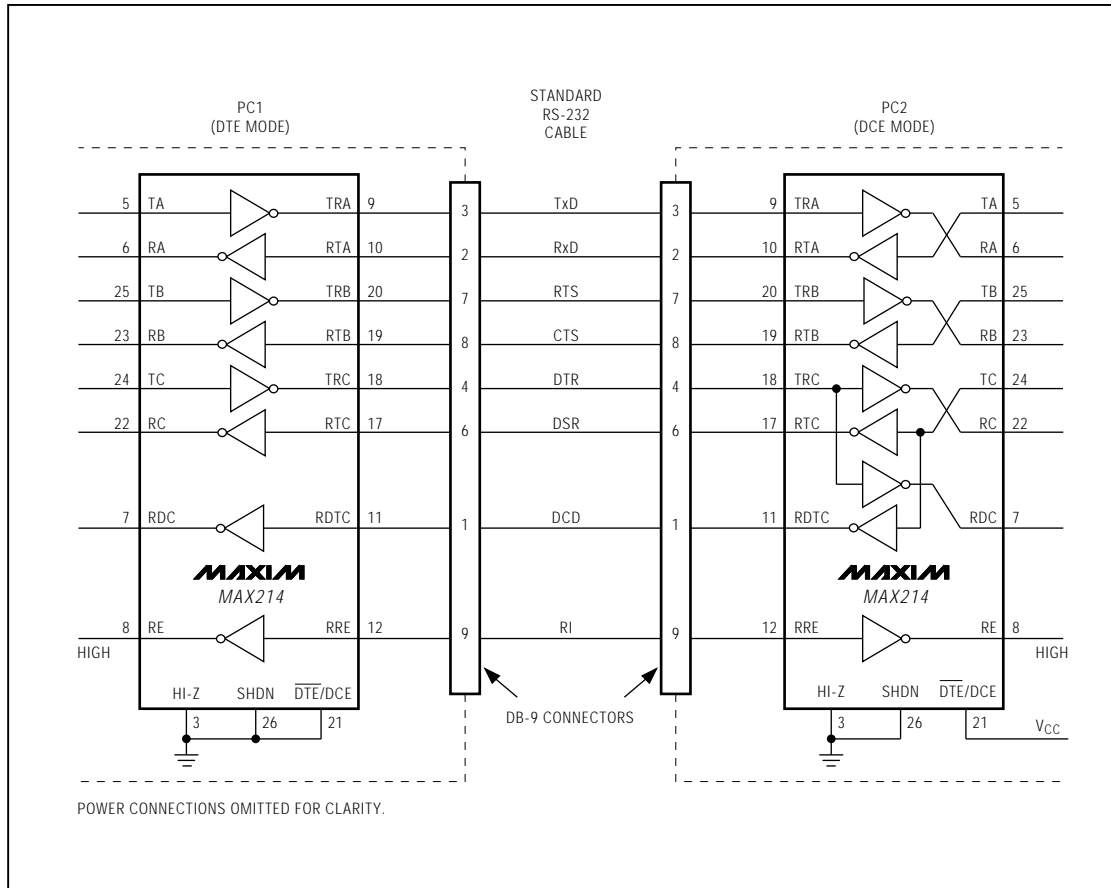

Figure 4. Typical Application Circuit Showing 2 PCs with Both DTE and DCE Operation

# Programmable DTE/DCE, +5V RS-232 Transceiver

**Table 3. Summary of EIA/TIA-232E, V.28 Specifications**

PARAMETER	CONDITIONS	EIA/TIA-232E, V.28 SPECIFICATIONS
Driver Output Voltage 0 Level 1 Level Output Level, Max	3kΩ to 7kΩ load	+5.0V to +15V
	3kΩ to 7kΩ load	-5.0V to -15V
	No load	±25V
Data Rate	3kΩ ≤ R <sub>L</sub> ≤ 7kΩ, C <sub>L</sub> ≤ 2500pF	Up to 20kbits/sec
Receiver Input Voltage 0 Level 1 Level Input Level, Max		+3.0V to +15V
		-3.0V to -15V
		±25V
Instantaneous Slew Rate, Max	3kΩ ≤ R <sub>L</sub> ≤ 7kΩ, C <sub>L</sub> ≤ 2500pF	30V/μs
Driver Output Short-Circuit Current, Max		100mA
Transition Rate on Driver Output	V.28	1ms or 3% of the period
	EIA/TIA-232E	4% of the period
Driver Output Resistance	-2V < V <sub>OUT</sub> < +2V	300Ω

Chip Topography

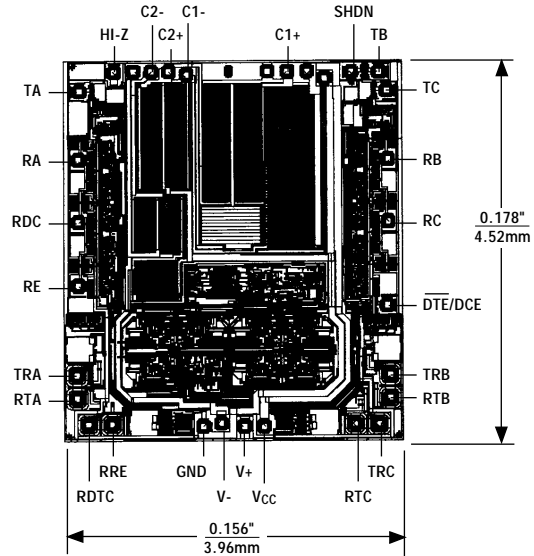

MAX214

TRANSISTOR COUNT: 694;  
SUBSTRATE CONNECTED TO V+.

**Table 4. DB9/DB25 Cable Connections Commonly Used for EIA/TIA-232 and V.24 Asynchronous Interfaces**

DB9 PIN	DB25 PIN	NAME	SYMBOL	FUNCTION
1	8	Received Line Signal Detector, sometimes called Data Carrier Detect	DCD	Handshake from DCE
2	3	Receive Data	RxD	Data from DCE
3	2	Transmit Data	TxD	Data from DTE
4	20	Data Terminal Ready	DTR	Handshake from DTE
5	7	Signal Ground	GND	Reference point for signals
6	6	Data Set Ready	DSR	Handshake from DCE
7	4	Request to Send	RTS	Handshake from DTE
8	5	Clear to Send	CTS	Handshake from DCE
9	22	Ring Indicator	RI	Handshake from DCE

# Programmable DTE/DCE, +5V RS-232 Transceiver

## Package Information

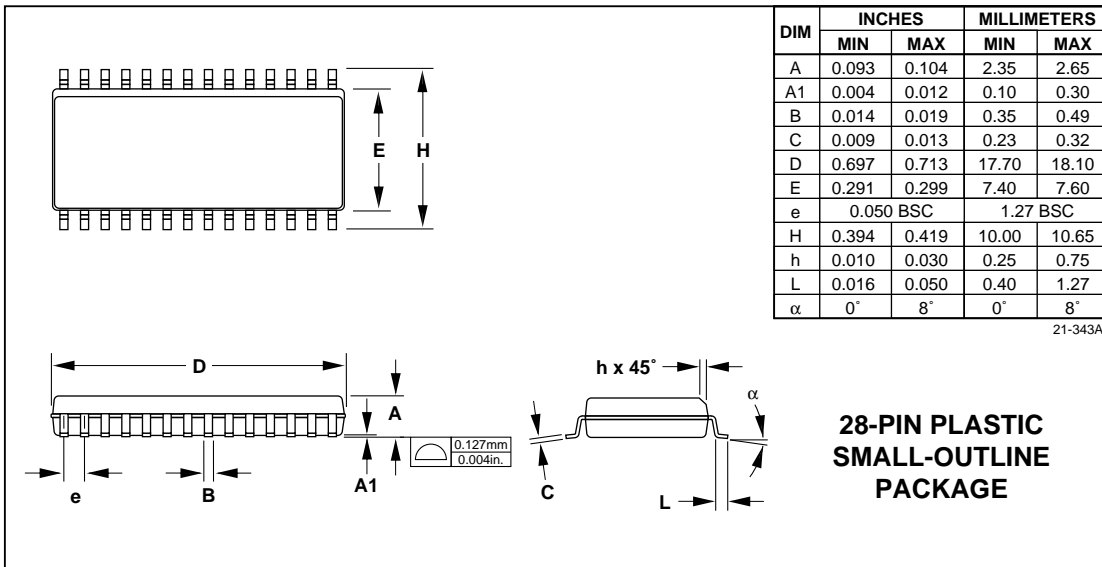
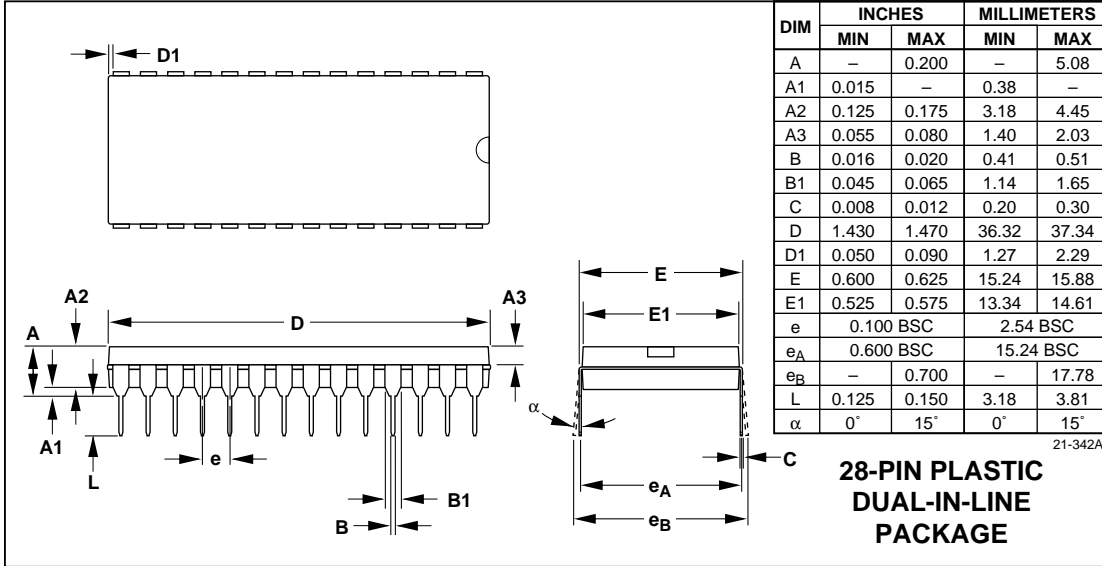

Maxim cannot assume responsibility for use of any circuitry other than circuitry entirely embodied in a Maxim product. No circuit patent licenses are implied. Maxim reserves the right to change the circuitry and specifications without notice at any time.

12 Maxim Integrated Products, 120 San Gabriel Drive, Sunnyvale, CA 94086 (408) 737-7600

© 1995 Maxim Integrated Products

Printed USA

MAXIM is a registered trademark of Maxim Integrated Products.