

NSC800™ High-Performance Low-Power CMOS Microprocessor

General Description

The NSC800 is an 8-bit CMOS microprocessor that functions as the central processing unit (CPU) in National Semiconductor's NSC800 microcomputer family. National's microCMOS technology used to fabricate this device provides system designers with performance equivalent to comparable NMOS products, but with the low power advantage of CMOS. Some of the many system functions incorporated on the device, are vectored priority interrupts, refresh control, power-save feature and interrupt acknowledge. The NSC800 is available in dual-in-line and surface mounted chip carrier packages.

The system designer can choose not only from the dedicated CMOS peripherals that allow direct interfacing to the NSC800 but from the full line of National's CMOS products to allow a low-power system solution. The dedicated peripherals include NSC810A RAM I/O Timer, NSC858 UART, and NSC831 I/O.

All devices are available in commercial, industrial and military temperature ranges along with two added reliability flows. The first is an extended burn in test and the second is the military class C screening in accordance with Method 5004 of MIL-STD-883.

Features

- Fully compatible with Z80® instruction set:
 - Powerful set of 158 instructions
 - 10 addressing modes
 - 22 internal registers
- Low power: 50 mW at 5V V_{CC}
- Unique power-save feature
- Multiplexed bus structure
- Schmitt trigger input on reset
- On-chip bus controller and clock generator
- Variable power supply 2.4V – 6.0V
- On-chip 8-bit dynamic RAM refresh circuitry
- Speed: 1.0 μs instruction cycle at 4.0 MHz
 - NSC800-4 4.0 MHz
 - NSC800-35 3.5 MHz
 - NSC800-3 2.5 MHz
 - NSC800-1 1.0 MHz
- Capable of addressing 64k bytes of memory and 256 I/O devices
- Five interrupt request lines on-chip

Block Diagram

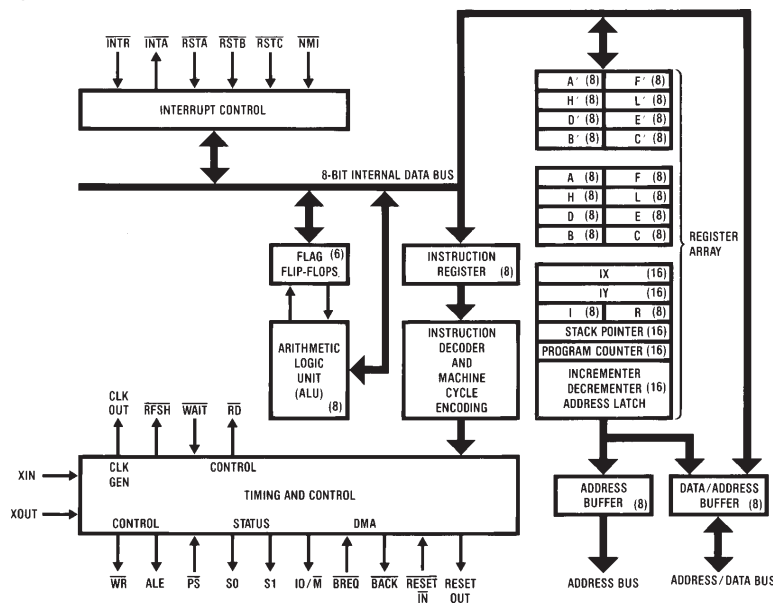

TL/C/5171-73

NSC800™ is a trademark of National Semiconductor Corp.
 TRI-STATE® is a registered trademark of National Semiconductor Corp.
 Z80® is a registered trademark of Zilog Corp.

Table of Contents

1.0 ABSOLUTE MAXIMUM RATINGS

2.0 OPERATING CONDITIONS

3.0 DC ELECTRICAL CHARACTERISTICS

4.0 AC ELECTRICAL CHARACTERISTICS

5.0 TIMING WAVEFORMS

NSC800 HARDWARE

6.0 PIN DESCRIPTIONS

- 6.1 Input Signals
- 6.2 Output Signals
- 6.3 Input/Output Signals

7.0 CONNECTION DIAGRAMS

8.0 FUNCTIONAL DESCRIPTION

- 8.1 Register Array
- 8.2 Dedicated Registers
 - 8.2.1 Program Counter
 - 8.2.2 Stack Pointer
 - 8.2.3 Index Register
 - 8.2.4 Interrupt Register
 - 8.2.5 Refresh Register
- 8.3 CPU Working and Alternate Register Sets
 - 8.3.1 CPU Working Registers
 - 8.3.2 Alternate Registers
- 8.4 Register Functions
 - 8.4.1 Accumulator
 - 8.4.2 F Register—Flags
 - 8.4.3 Carry (C)
 - 8.4.4 Adds/Subtract (N)
 - 8.4.5 Parity/Overflow (P/V)
 - 8.4.6 Half Carry (H)
 - 8.4.7 Zero Flag (Z)
 - 8.4.8 Sign Flag (S)
 - 8.4.9 Additional General Purpose Registers
 - 8.4.10 Alternate Configurations
- 8.5 Arithmetic Logic Unit (ALU)
- 8.6 Instruction Register and Decoder

9.0 TIMING AND CONTROL

- 9.1 Internal Clock Generator
- 9.2 CPU Timing
- 9.3 Initialization
- 9.4 Power Save Feature

9.0 TIMING AND CONTROL

- 9.5 Bus Access Control
- 9.6 Interrupt Control

NSC800 SOFTWARE

10.0 INTRODUCTION

11.0 ADDRESSING MODES

- 11.1 Register
- 11.2 Implied
- 11.3 Immediate
- 11.4 Immediate Extended
- 11.5 Direct Addressing
- 11.6 Register Indirect
- 11.7 Indexed
- 11.8 Relative
- 11.9 Modified Page Zero
- 11.10 Bit

12.0 INSTRUCTION SET

- 12.1 Instruction Set Index/Alphabetical
- 12.2 Instruction Set Mnemonic Notation
- 12.3 Assembled Object Code Notation
- 12.4 8-Bit Loads
- 12.5 16-Bit Loads
- 12.6 8-Bit Arithmetic
- 12.7 16-Bit Arithmetic
- 12.8 Bit Set, Reset, and Test
- 12.9 Rotate and Shift
- 12.10 Exchanges
- 12.11 Memory Block Moves and Searches
- 12.12 Input/Output
- 12.13 CPU Control
- 12.14 Program Control
- 12.15 Instruction Set: Alphabetical Order
- 12.16 Instruction Set: Numerical Order

13.0 DATA ACQUISITION SYSTEM

14.0 NSC800M/883B MIL STD 883/CLASS C SCREENING

15.0 BURN-IN CIRCUITS

16.0 ORDERING INFORMATION

17.0 RELIABILITY INFORMATION

1.0 Absolute Maximum Ratings (Note 1)

If Military/Aerospace specified devices are required, please contact the National Semiconductor Sales Office/Distributors for availability and specifications.

Storage Temperature	-65°C to +150°C
Voltage on Any Pin with Respect to Ground	-0.3V to $V_{CC} + 0.3V$
Maximum V_{CC}	7V
Power Dissipation	1W
Lead Temp. (Soldering, 10 seconds)	300°C

2.0 Operating Conditions

NSC800-1	→ $T_A = 0^\circ\text{C}$ to $+70^\circ\text{C}$ $T_A = -40^\circ\text{C}$ to $+85^\circ\text{C}$
NSC800-3	→ $T_A = 0^\circ\text{C}$ to $+70^\circ\text{C}$ $T_A = -40^\circ\text{C}$ to $+85^\circ\text{C}$ $T_A = -55^\circ\text{C}$ to $+125^\circ\text{C}$
NSC800-35/883C	→ $T_A = -55^\circ\text{C}$ to $+125^\circ\text{C}$
NSC800-4	→ $T_A = 0^\circ\text{C}$ to $+70^\circ\text{C}$ $T_A = -40^\circ\text{C}$ to $+85^\circ\text{C}$
NSC800-4MIL	→ $T_A = -55^\circ\text{C}$ to $+90^\circ\text{C}$

3.0 DC Electrical Characteristics $V_{CC} = 5V \pm 10\%$, GND = 0V, unless otherwise specified.

Symbol	Parameter	Conditions	Min	Typ	Max	Units
V_{IH}	Logical 1 Input Voltage		$0.8 V_{CC}$		V_{CC}	V
V_{IL}	Logical 0 Input Voltage		0		$0.2 V_{CC}$	V
V_{HY}	Hysteresis at RESET IN input	$V_{CC} = 5V$	0.25	0.5		V
V_{OH1}	Logical 1 Output Voltage	$I_{OUT} = -1.0 \text{ mA}$	2.4			V
V_{OH2}	Logical 1 Output Voltage	$I_{OUT} = -10 \mu\text{A}$	$V_{CC} - 0.5$			V
V_{OL1}	Logical 0 Output Voltage	$I_{OUT} = 2 \text{ mA}$	0		0.4	V
V_{OL2}	Logical 0 Output Voltage	$I_{OUT} = 10 \mu\text{A}$	0		0.1	V
I_{IL}	Input Leakage Current	$0 \leq V_{IN} \leq V_{CC}$	-10.0		10.0	μA
I_{OL}	Output Leakage Current	$0 \leq V_{IN} \leq V_{CC}$	-10.0		10.0	μA
I_{CC}	Active Supply Current	$I_{OUT} = 0$, $f_{(XIN)} = 2 \text{ MHz}$, $T_A = 25^\circ\text{C}$		8	11	mA
I_{CC}	Active Supply Current	$I_{OUT} = 0$, $f_{(XIN)} = 5 \text{ MHz}$, $T_A = 25^\circ\text{C}$		10	15	mA
I_{CC}	Active Supply Current	$I_{OUT} = 0$, $f_{(XIN)} = 7 \text{ MHz}$, $T_A = 25^\circ\text{C}$		15	21	mA
I_{CC}	Active Supply Current	$I_{OUT} = 0$, $f_{(XIN)} = 8 \text{ MHz}$, $T_A = 25^\circ\text{C}$		15	21	mA
I_Q	Quiescent Current	$I_{OUT} = 0$, $\overline{PS} = 0$, $V_{IN} = 0$ or $V_{IN} = V_{CC}$ $f_{(XIN)} = 0 \text{ MHz}$, $T_A = 25^\circ\text{C}$, $X_{IN} = 0$, $CLK = 1$		2	5	mA
I_{PS}	Power-Save Current	$I_{OUT} = 0$, $\overline{PS} = 0$, $V_{IN} = 0$ or $V_{IN} = V_{CC}$ $f_{(XIN)} = 5.0 \text{ MHz}$, $T_A = 25^\circ$		5	7	mA
C_{IN}	Input Capacitance			6	10	pF
C_{OUT}	Output Capacitance			8	12	pF
V_{CC}	Power Supply Voltage	(Note 2)	2.4	5	6	V

Note 1: Absolute Maximum Ratings indicate limits beyond which permanent damage may occur. Continuous operation at these limits is not intended and should be limited to those conditions specified under DC Electrical Characteristics.

Note 2: CPU operation at lower voltages will reduce the maximum operating speed. Operation at voltages other than $5V \pm 10\%$ is guaranteed by design, not tested.

4.0 AC Electrical Characteristics $V_{CC} = 5V \pm 10\%$, $GND = 0V$, unless otherwise specified

Symbol	Parameter	NSC800-1		NSC800-3		NSC800-35		NSC800-4		Units	Notes
		Min	Max	Min	Max	Min	Max	Min	Max		
t_X	Period at XIN and XOUT Pins	500	3333	200	3333	142	3333	125	3333	ns	
T	Period at Clock Output (= 2 t_X)	1000	6667	400	6667	284	6667	250	6667	ns	
t_R	Clock Rise Time		110		110		90		80	ns	Measured from 10%–90% of signal
t_F	Clock Fall Time		70		60		55		50	ns	Measured from 10%–90% of signal
t_L	Clock Low Time	435		150		90		80		ns	50% duty cycle, square wave input on XIN
t_H	Clock High Time	450		145		85		75		ns	50% duty cycle, square wave input on XIN
$t_{ACC(OP)}$	ALE to Valid Data		1340		490		340		300	ns	Add t for each WAIT STATE
$t_{ACC(MR)}$	ALE to Valid Data		1875		620		405		360	ns	Add t for each WAIT STATE
t_{AFR}	AD(0–7) Float after \overline{RD} Falling		0		0		0		0	ns	
t_{BABE}	\overline{BACK} Rising to Bus Enable		1000		400		300		250	ns	
t_{BABF}	\overline{BACK} Falling to Bus Float		50		50		50		50	ns	
t_{BACL}	\overline{BACK} Fall to CLK Falling	425		125		60		55		ns	
t_{BRH}	\overline{BREQ} Hold Time	0		0		0		0		ns	
t_{BRS}	\overline{BREQ} Set-Up Time	100		50		50		45		ns	
t_{CAF}	Clock Falling ALE Falling	0	70	0	65	0	60	0	55	ns	
t_{CAR}	Clock Rising to ALE Rising	0	100	0	100	0	90	0	80	ns	
t_{CRD}	Clock Rising to Read Rising		100		90		90		80	ns	
t_{CRF}	Clock Rising to Refresh Falling		80		70		70		65	ns	
t_{DAI}	ALE Falling to \overline{INTA} Falling	445		160		95		85		ns	
t_{DAR}	ALE Falling to \overline{RD} Falling	400	575	160	250	100	180	90	160	ns	
t_{DAW}	ALE Falling to \overline{WR} Falling	900	1010	350	420	225	300	200	265	ns	
$t_{D(BACK)1}$	ALE Falling to \overline{BACK} Falling	2460		975		635		560		ns	Add t for each WAIT state Add t for opcode fetch cycles
$t_{D(BACK)2}$	\overline{BREQ} Rising to \overline{BACK} Rising	500	1610	200	700	140	540	125	475	ns	
$t_{D(I)}$	ALE Falling to \overline{INTR} , \overline{NMI} , $\overline{RSTA-C}$, \overline{PS} , \overline{BREQ} , Inputs Valid		1360		475		284		250	ns	Add t for each WAIT state Add t for opcode fetch cycles
t_{DPA}	Rising \overline{PS} to Falling ALE	500	1685	200	760	140	580	125	510	ns	See Figure 14 also
$t_{D(WAIT)}$	ALE Falling to WAIT Input Valid		550		250		170		125	ns	

OP— Opcode Fetch
MR— Memory Read

4.0 AC Electrical Characteristics $V_{CC} = 5V \pm 10\%$, $GND = 0V$, unless otherwise specified (Continued)

Symbol	Parameter	NSC800-1		NSC800-3		NSC800-35		NSC800-4		Units	Notes
		Min	Max	Min	Max	Min	Max	Min	Max		
$T_{H(ADH)1}$	A(8–15) Hold Time During Opcode Fetch	0		0		0		0		ns	
$T_{H(ADH)2}$	A(8–15) Hold Time During Memory or IO, \overline{RD} and \overline{WR}	400		100		85		60		ns	
$T_{H(ADL)}$	AD(0–7) Hold Time	100		60		35		30		ns	
$T_{H(WD)}$	Write Data Hold Time	400		100		85		75		ns	
t_{INH}	Interrupt Hold Time	0		0		0		0		ns	
t_{INS}	Interrupt Set-Up Time	100		50		50		45		ns	
t_{NMI}	Width of NMI Input	50		30		25		20		ns	
t_{RDH}	Data Hold after Read	0		0		0		0		ns	
t_{RFLF}	\overline{RFSH} Rising to ALE Falling	60		50		45		40		ns	
$t_{RL(MR)}$	\overline{RD} Rising to ALE Rising (Memory Read)	390		100		50		45		ns	
$t_{S(AD)}$	AD(0–7) Set-Up Time	300		45		45		40		ns	
$t_{S(ALE)}$	A(8–15), SO, SI, IO/ \overline{M} Set-Up Time	350		70		55		50		ns	
$t_{S(WD)}$	Write Data Set-Up Time	385		75		35		30		ns	
$t_{W(ALE)}$	ALE Width	430		130		115		100		ns	
t_{WH}	\overline{WAIT} Hold Time	0		0		0		0		ns	
$t_{W(I)}$	Width of \overline{INTR} , $\overline{RSTA-C}$, \overline{PS} , \overline{BREQ}	500		200		140		125		ns	
$t_{W(INTA)}$	\overline{INTA} Strobe Width	1000		400		225		200		ns	Add two t states for first \overline{INTA} of each interrupt response string Add t for each \overline{WAIT} state
t_{WL}	\overline{WR} Rising to ALE Rising	450		130		70		70		ns	
$t_{W(RD)}$	Read Strobe Width During Opcode Fetch	960		360		210		185		ns	Add t for each \overline{WAIT} State Add t/2 for Memory Read Cycles
$t_{W(RFSH)}$	Refresh Strobe Width	1925		725		450		395		ns	
t_{WS}	\overline{WAIT} Set-Up Time	100		70		60		55		ns	
$t_{W(WAIT)}$	\overline{WAIT} Input Width	550		250		195		175		ns	
$t_{W(WR)}$	Write Strobe Width	985		370		250		220		ns	Add t for each \overline{WAIT} state
t_{XCF}	XIN to Clock Falling	25	100	15	95	5	90	5	80	ns	
t_{XCR}	XIN to Clock Rising	25	85	15	85	5	90	5	80	ns	

Note 1: Test conditions: t = 1000 ns for NSC800-1, 400 ns for NSC800, 285 ns for NSC800-35, 250 ns for NSC800-4.

Note 2: Output timings are measured with a purely capacitive load of 100 pF.

5.0 Timing Waveforms

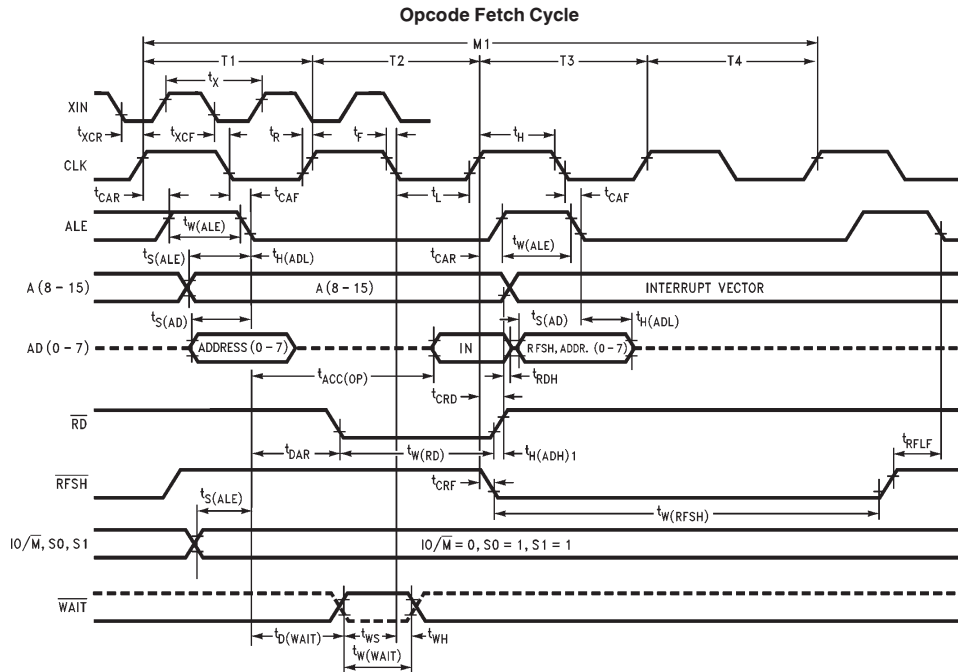

TL/C/5171-3

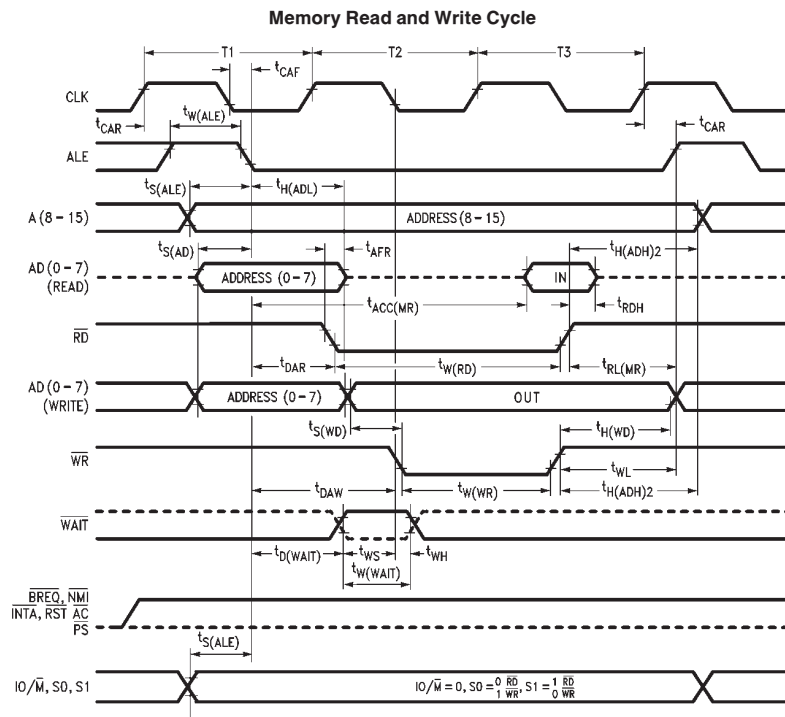

TL/C/5171-4

5.0 Timing Waveforms (Continued)

Interrupt—Power-Save Cycle

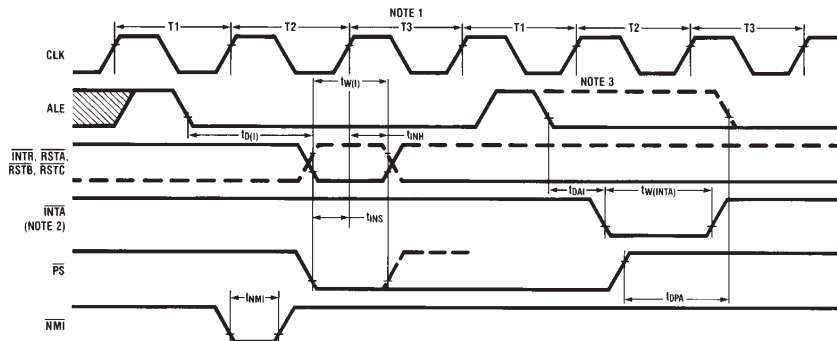

TL/C/5171-5

Note 1: This t state is the last t state of the last M cycle of any instruction.

Note 2: Response to INTR input.

Note 3: Response to PS input.

Bus Acknowledge Cycle

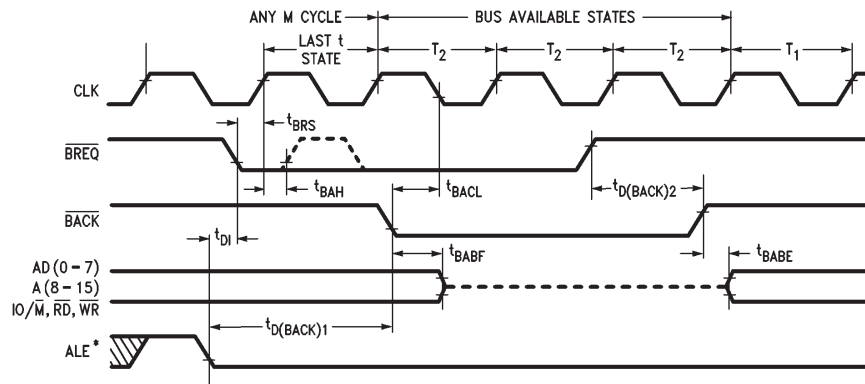

TL/C/5171-6

*Waveform not drawn to proportion. Use only for specifying test points.

AC Testing Input/Output Waveform

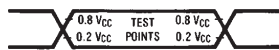

TL/C/5171-7

AC Testing Load Circuit

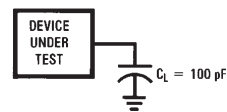

TL/C/5171-8

NSC800 HARDWARE

6.0 Pin Descriptions

6.1 INPUT SIGNALS

Reset Input ($\overline{\text{RESET IN}}$): Active low. Sets A (8–15) and AD (0–7) to TRI-STATE® (high impedance). Clears the contents of PC, I and R registers, disables interrupts, and activates reset out.

Bus Request ($\overline{\text{BREQ}}$): Active low. Used when another device requests the system bus. The NSC800 recognizes $\overline{\text{BREQ}}$ at the end of the current machine cycle, and sets A(8–15), AD(0–7), IO/ $\overline{\text{M}}$, $\overline{\text{RD}}$, and $\overline{\text{WR}}$ to the high impedance state. $\overline{\text{RFSH}}$ is high during a bus request cycle. The CPU acknowledges the bus request via the $\overline{\text{BACK}}$ output signal.

Non-Maskable Interrupt ($\overline{\text{NMI}}$): Active low. The non-maskable interrupt, generated by the peripheral device(s), is the highest priority interrupt. The edge sensitive interrupt requires only a pulse to set an internal flip-flop which generates the internal interrupt request. The $\overline{\text{NMI}}$ flip-flop is monitored on the same clock edge as the other interrupts. It must also meet the minimum set-up time spec for the interrupt to be accepted in the current machine instruction. When the processor accepts the interrupt the flip-flop resets automatically. Interrupt execution is independent of the interrupt enable flip-flop. $\overline{\text{NMI}}$ execution results in saving the PC on the stack and automatic branching to restart address X'0066 in memory.

Restart Interrupts, A, B, C ($\overline{\text{RSTA}}$, $\overline{\text{RSTB}}$, $\overline{\text{RSTC}}$): Active low level sensitive. The CPU recognizes restarts generated by the peripherals at the end of the current instruction, if their respective interrupt enable and master enable bits are set. Execution is identical to $\overline{\text{NMI}}$ except the interrupts vector to the following restart addresses:

Name	Restart Address (X')
$\overline{\text{NMI}}$	0066
$\overline{\text{RSTA}}$	003C
$\overline{\text{RSTB}}$	0034
$\overline{\text{RSTC}}$	002C
$\overline{\text{INTR}}$ (Mode 1)	0038

The order of priority is fixed. The list above starts with the highest priority.

Interrupt Request ($\overline{\text{INTR}}$): Active low, level sensitive. The CPU recognizes an interrupt request at the end of the current instruction provided that the interrupt enable and master interrupt enable bits are set. $\overline{\text{INTR}}$ is the lowest priority interrupt. Program control selects one of three response modes which determines the method of servicing $\overline{\text{INTR}}$ in conjunction with $\overline{\text{INTA}}$. See Interrupt Control.

Wait ($\overline{\text{WAIT}}$): Active low. When set low during $\overline{\text{RD}}$, $\overline{\text{WR}}$ or $\overline{\text{INTA}}$ machine cycles (during the $\overline{\text{WR}}$ machine cycle, wait must be valid prior to write going active) the CPU extends its machine cycle in increments of t (wait) states. The wait machine cycle continues until the $\overline{\text{WAIT}}$ input returns high.

The wait strobe input will be accepted only during machine cycles that have $\overline{\text{RD}}$, $\overline{\text{WR}}$ or $\overline{\text{INTA}}$ strobes and during the machine cycle immediately after an interrupt has been accepted by the CPU. The later cycle has its RD strobe suppressed but it will still accept the wait.

Power-Save ($\overline{\text{PS}}$): Active low. $\overline{\text{PS}}$ is sampled during the last t state of the current instruction cycle. When $\overline{\text{PS}}$ is low, the

CPU stops executing at the end of current instruction and keeps itself in the low-power mode. Normal operation resumes when $\overline{\text{PS}}$ returns high (see Power Save Feature description).

CRYSTAL (X_{IN} , X_{OUT}): X_{IN} can be used as an external clock input. A crystal can be connected across X_{IN} and X_{OUT} to provide a source for the system clock.

6.2 OUTPUT SIGNALS

Bus Acknowledge ($\overline{\text{BACK}}$): Active low. $\overline{\text{BACK}}$ indicates to the bus requesting device that the CPU bus and its control signals are in the TRI-STATE mode. The requesting device then commands the bus and its control signals.

Address Bits 8–15 [$A(8-15)$]: Active high. These are the most significant 8 bits of the memory address during a memory instruction. During an I/O instruction, the port address on the lower 8 address bits gets duplicated onto A(8–15). During a BREQ/BACK cycle, the A(8–15) bus is in the TRI-STATE mode.

Reset Out ($\overline{\text{RESET OUT}}$): Active high. When RESET OUT is high, it indicates the CPU is being reset. This signal is normally used to reset the peripheral devices.

Input/Output/Memory (IO/ $\overline{\text{M}}$): An active high on the IO/ $\overline{\text{M}}$ output signifies that the current machine cycle is an input/output cycle. An active low on the IO/ $\overline{\text{M}}$ output signifies that the current machine cycle is a memory cycle. It is TRI-STATE during BREQ/BACK cycles.

Refresh ($\overline{\text{RFSH}}$): Active low. The refresh output indicates that the dynamic RAM refresh cycle is in progress. $\overline{\text{RFSH}}$ goes low during T3 and T4 states of all M1 cycles. During the refresh cycle, AD(0–7) has the refresh address and A(8–15) indicates the interrupt vector register data. $\overline{\text{RFSH}}$ is high during BREQ/BACK cycles.

Address Latch Enable (ALE): Active high. ALE is active only during the T1 state of any M cycle and also T3 state of the M1 cycle. The high to low transition of ALE indicates that a valid memory, I/O or refresh address is available on the AD(0–7) lines.

Read Strobe ($\overline{\text{RD}}$): Active low. The CPU receives data via the AD(0–7) lines on the trailing edge of the $\overline{\text{RD}}$ strobe. The $\overline{\text{RD}}$ line is in the TRI-STATE mode during BREQ/BACK cycles.

Write Strobe ($\overline{\text{WR}}$): Active low. The CPU sends data via the AD(0–7) lines while the $\overline{\text{WR}}$ strobe is low. The $\overline{\text{WR}}$ line is in the TRI-STATE mode during BREQ/BACK cycles.

Clock (CLK): CLK is the output provided for use as a system clock. The CLK output is a square wave at one half the input frequency.

Interrupt Acknowledge ($\overline{\text{INTA}}$): Active low. This signal strobes the interrupt response vector from the interrupting peripheral devices onto the AD(0–7) lines. $\overline{\text{INTA}}$ is active during the M1 cycle immediately following the t state where the CPU recognized the $\overline{\text{INTR}}$ interrupt request.

Two of the three interrupt request modes use $\overline{\text{INTA}}$. In mode 0 one to four $\overline{\text{INTA}}$ signals strobe a one to four byte instruction onto the AD(0–7) lines. In mode 2 one $\overline{\text{INTA}}$ signal strobes the lower byte of an interrupt response vector onto the bus. In mode 1, $\overline{\text{INTA}}$ is inactive and the CPU response to $\overline{\text{INTR}}$ is the same as for an NMI or restart interrupt.

6.0 Pin Descriptions (Continued)

Status (S0, S1): Bus status outputs provide encoded information regarding the current M cycle as follows:

Machine Cycle	Status			Control	
	S0	S1	IO/M	RD	WR
Opcode Fetch	1	1	0	0	1
Memory Read	0	1	0	0	1
Memory Write	1	0	0	1	0
I/O Read	0	1	1	0	1
I/O Write	1	0	1	1	0
Halt*	0	0	0	0	1
Internal Operation*	0	1	0	1	1
Acknowledge of Int**	1	1	0	1	1

*ALE is not suppressed in this cycle.

**This is the cycle that occurs immediately after the CPU accepts an interrupt (RSTA, RSTB, RSTC, INTR, NMI).

Note 1: During halt, CPU continues to do dummy opcode fetch from location following the halt instruction with a halt status. This is so CPU can continue to do its dynamic RAM refresh.

Note 2: No early status is provided for interrupt or hardware restarts.

6.3 INPUT/OUTPUT SIGNALS

Multiplexed Address/Data [AD(0-7)]: Active high

At \overline{RD} Time: Input data to CPU.

At \overline{WR} Time: Output data from CPU.

At Falling Edge of ALE Time: Least significant byte of address port address during I/O reference cycle.

During $\overline{BREQ}/$ \overline{BACK} Cycle: High impedance.

7.0 Connection Diagrams

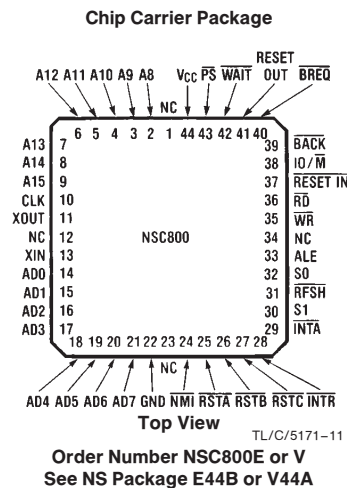
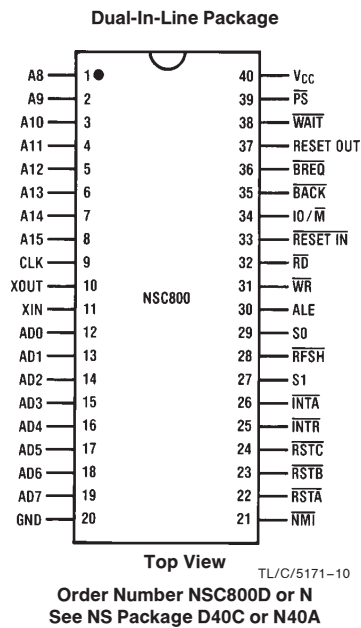

8.0 Functional Description

This section reviews the CPU architecture shown below, focusing on the functional aspects from a hardware perspective, including timing details.

As illustrated in *Figure 1*, the NSC800 is an 8-bit parallel device. The major functional blocks are: the ALU, register array, interrupt control, timing and control logic. These areas are connected via the 8-bit internal data bus. Detailed descriptions of these blocks are provided in the following sections.

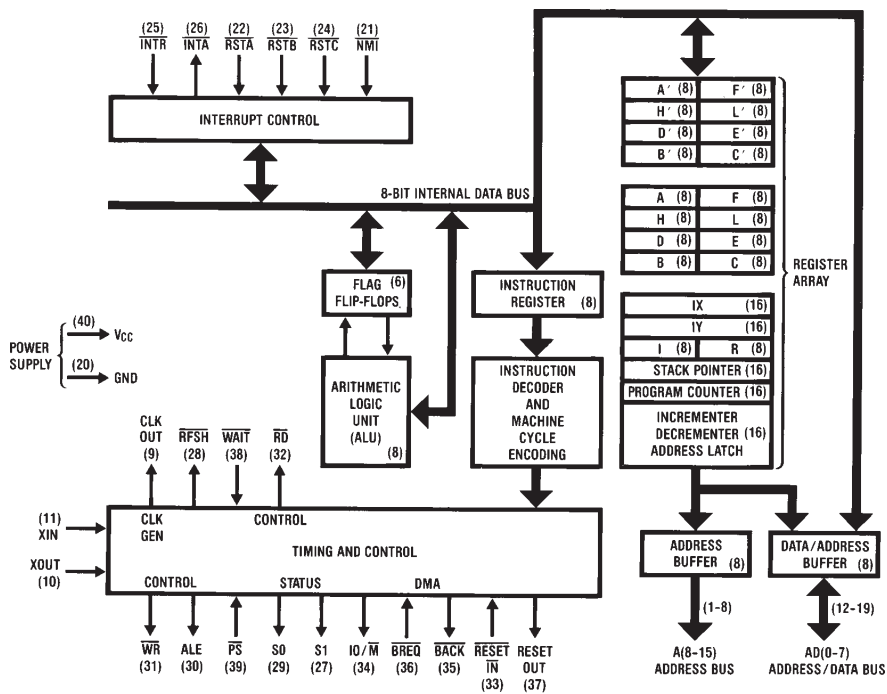

Note: Applicable pinout for 40-pin dual-in-line package within parentheses

TL/C/5171-9

FIGURE 1. NSC800 CPU Functional Block Diagram

8.0 Functional Description (Continued)

8.1 REGISTER ARRAY

The NSC800 register array is divided into two parts: the dedicated registers and the working registers, as shown in Figure 2.

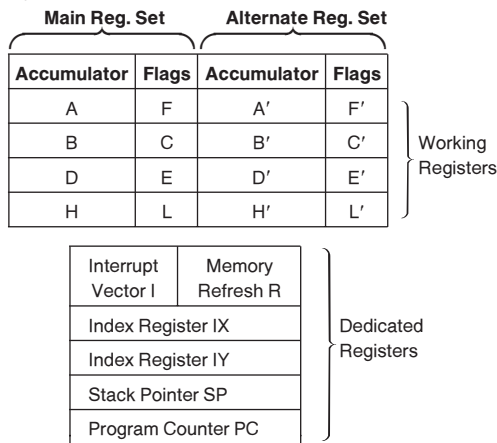

FIGURE 2. NSC800 Register Array

8.2 DEDICATED REGISTERS

There are 6 dedicated registers in the NSC800: two 8-bit and four 16-bit registers (see Figure 3).

Although their contents are under program control, the program has no control over their operational functions, unlike the CPU working registers. The function of each dedicated register is described as follows:

CPU Dedicated Registers

Program Counter PC	(16)
Stack Pointer SP	(16)
Index Register IX	(16)
Index Register IY	(16)
Interrupt Vector Register I	(8)
Memory Refresh Register R	(8)

FIGURE 3. Dedicated Registers

8.2.1 Program Counter (PC)

The program counter contains the 16-bit address of the current instruction being fetched from memory. The PC increments after its contents have been transferred to the address lines. When a program jump occurs, the PC receives the new address which overrides the incrementer.

There are many conditional and unconditional jumps, calls, and return instructions in the NSC800's instruction repertoire that allow easy manipulation of this register in controlling the program execution (i.e. JP NZ nn, JR Zd2, CALL NC, nn).

8.2.2 Stack Pointer (SP)

The 16-bit stack pointer contains the address of the current top of stack that is located in external system RAM. The stack is organized in a last-in, first-out (LIFO) structure. The pointer decrements before data is pushed onto the stack, and increments after data is popped from the stack.

Various operations store or retrieve, data on the stack. This, along with the usage of subroutine calls and interrupts, allows simple implementation of subroutine and interrupt nesting as well as alleviating many problems of data manipulation.

8.2.3 Index Register (IX and IY)

The NSC800 contains two index registers to hold independent, 16-bit base addresses used in the indexed addressing mode. In this mode, an index register, either IX or IY, contains a base address of an area in memory making it a pointer for data tables.

In all instructions employing indexed modes of operation, another byte acts as a signed two's complement displacement. This addressing mode enables easy data table manipulations.

8.2.4 Interrupt Register (I)

When the NSC800 provides a Mode 2 response to $\overline{\text{INTR}}$, the action taken is an indirect call to the memory location containing the service routine address. The pointer to the address of the service routine is formed by two bytes, the high-byte is from the I Register and the low-byte is from the interrupting peripheral. The peripheral always provides an even address for the lower byte (LSB=0). When the processor receives the lower byte from the peripheral it concatenates it in the following manner:

I Register	External byte
8 bits	0

↑

The LSB of the external byte must be zero.

FIGURE 4a. Interrupt Register

The even memory location contains the low-order byte, the next consecutive location contains the high-order byte of the pointer to the beginning address of the interrupt service routine.

8.2.5 Refresh Register (R)

For systems that use dynamic memories rather than static RAM's, the NSC800 provides an integral 8-bit memory refresh counter. The contents of the register are incremented after each opcode fetch and are sent out on the lower portion of the address bus, along with a refresh control signal. This provides a totally transparent refresh cycle and does not slow down CPU operation.

The program can read and write to the R register, although this is usually done only for test purposes.

8.0 Functional Description (Continued)

8.3 CPU WORKING AND ALTERNATE REGISTER SETS

8.3.1 CPU Working Registers

The portion of the register array shown in *Figure 4b* represents the CPU working registers. These sixteen 8-bit registers are general-purpose registers because they perform a multitude of functions, depending on the instruction being executed. They are grouped together also due to the types of instructions that use them, particularly alternate set operations.

The F (flag) register is a special-purpose register because its contents are more a result of machine status rather than program data. The F register is included because of its interaction with the A register, and its manipulations in the alternate register set operations.

8.3.2 Alternate Registers

The NSC800 registers designated as CPU working registers have one common feature: the existence of a duplicate register in an alternate register set. This architectural concept simplifies programming during operations such as interrupt response, when the machine status represented by the contents of the registers must be saved.

The alternate register concept makes one set of registers available to the programmer at any given time. Two instructions (EX AF, A'F' and EXX), exchange the current working set of registers with their alternate set. One exchange between the A and F registers and their respective duplicates (A' and F') saves the primary status information contained in the accumulator and the flag register. The second exchange instruction performs the exchange between the remaining registers, B, C, D, E, H, and L, and their respective alternates B', C', D', E', H', and L'. This essentially saves the contents of the original complement of registers while providing the programmer with a usable alternate set.

CPU Main Working Register Set

Accumulator A	(8)	Flags F	(8)
Register B	(8)	Register C	(8)
Register D	(8)	Register E	(8)
Register H	(8)	Register L	(8)

CPU Alternate Working Register Set

Accumulator A'	(8)	Flags F'	(8)
Register B'	(8)	Register C'	(8)
Register D'	(8)	Register E'	(8)
Register H'	(8)	Register L'	(8)

FIGURE 4b. CPU Working and Alternate Registers

8.4 REGISTER FUNCTIONS

8.4.1 Accumulator (A Register)

The A register serves as a source or destination register for data manipulation instructions. In addition, it serves as the accumulator for the results of 8-bit arithmetic and logic operations.

The A register also has a special status in some types of operations; that is, certain addressing modes are reserved for the A register only, although the function is available for all the other registers. For example, any register can be loaded by immediate, register indirect, or indexed addressing modes. The A register, however, can also be loaded via an additional register indirect addressing.

Another special feature of the A register is that it produces more efficient memory coding than equivalent instruction functions directed to other registers. Any register can be rotated; however, while it requires a two-byte instruction to normally rotate any register, a single-byte instruction is available for rotating the contents of the accumulator (A register).

8.4.2 F Register - Flags

The NSC800 flag register consists of six status bits that contain information regarding the results of previous CPU operations. The register can be read by pushing the contents onto the stack and then reading it, however, it cannot be written to. It is classified as a register because of its affiliation with the accumulator and the existence of a duplicate register for use in exchange instructions with the accumulator.

Of the six flags shown in *Figure 5*, only four can be directly tested by the programmer via conditional jump, call, and return instructions. They are the Sign (S), Zero (Z), Parity/Overflow (P/V), and Carry (C) flags. The Half Carry (H) and Add/Subtract (N) flags are used for internal operations related to BCD arithmetic.

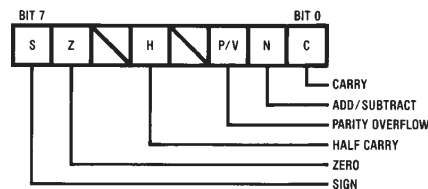

FIGURE 5. Flag Register

TL/C/5171-23

8.0 Functional Description (Continued)

8.4.3 Carry (C)

A carry from the highest order bit of the accumulator during an add instruction, or a borrow generated during a subtraction instruction sets the carry flag. Specific shift and rotate instructions also affect this bit.

Two specific instructions in the NSC800 instruction repertoire set (SCF) or complement (CCF) the carry flag.

Other operations that affect the C flag are as follows:

- Adds
- Subtracts
- Logic Operations (always resets C flag)
- Rotate Accumulator
- Rotate and Shifts
- Decimal Adjust
- Negation of Accumulator

Other operations do not affect the C flag.

8.4.4 Adds/Subtract (N)

This flag is used in conjunction with the H flag to ensure that the proper BCD correction algorithm is used during the decimal adjust instruction (DAA). The correction algorithm depends on whether an add or subtract was previously done with BCD operands.

The operations that set the N flag are:

- Subtractions
- Decrements (8-bit)
- Complementing of the Accumulator
- Block I/O
- Block Searches
- Negation of the Accumulator

The operations that reset the N flag are:

- Adds
- Increments
- Logic Operations
- Rotates
- Set and Complement Carry
- Input Register Indirect
- Block Transfers
- Load of the I or R Registers
- Bit Tests

Other operations do not affect the N flag.

8.4.5 Parity/Overflow (P/V)

The Parity/Overflow flag is a dual-purpose flag that indicates results of logic and arithmetic operations. In logic operations, the P/V flag indicates the parity of the result; the flag is set (high) if the result is even, reset (low) if the result is odd. In arithmetic operations, it represents an overflow condition when the result, interpreted as signed two's complement arithmetic, is out of range for the eight-bit accumulator (i.e. -128 to $+127$).

The following operations affect the P/V flag according to the parity of the result of the operation:

- Logic Operations
- Rotate and Shift
- Rotate Digits
- Decimal Adjust
- Input Register Indirect

The following operations affect the P/V flag according to the overflow result of the operation.

- Adds (16 bit with carry, 8-bit with/without carry)
- Subtracts (16 bit with carry, 8-bit with/without carry)
- Increments and Decrements
- Negation of Accumulator

The P/V flag has no significance immediately after the following operations.

- Block I/O
- Bit Tests

In block transfers and compares, the P/V flag indicates the status of the BC register, always ending in the reset state after an auto repeat of a block move. Other operations do not affect the P/V flag.

8.4.6 Half Carry (H)

This flag indicates a BCD carry, or borrow, result from the low-order four bits of operation. It can be used to correct the results of a previously packed decimal add, or subtract, operation by use of the Decimal Adjust Instruction (DAA).

The following operations affect the H flag:

- Adds (8-bit)
- Subtracts (8-bit)
- Increments and Decrements
- Decimal Adjust
- Negation of Accumulator
- Always Set by: Logic AND
Complement Accumulator
Bit Testing
- Always Reset By: Logic OR's and XOR's
Rotates and Shifts
Set Carry
Input Register Indirect
Block Transfers
Loads of I and R Registers

The H flag has no significance immediately after the following operations.

- 16-bit Adds with/without carry
- 16-Bit Subtracts with carry
- Complement of the carry
- Block I/O
- Block Searches

Other operations do not affect the H flag.

8.0 Functional Description (Continued)

8.4.7 Zero Flag (Z)

Loading a zero in the accumulator or when a zero results from an operation sets the zero flag.

The following operations affect the zero flag.

- Adds (16-bit with carry, 8-bit with/without carry)
- Subtracts (16-bit with carry, 8-bit with/without carry)
- Logic Operations
- Increments and Decrements
- Rotate and Shifts
- Rotate Digits
- Decimal Adjust
- Input Register Indirect
- Block I/O (always set after auto repeat block I/O)
- Block Searches
- Load of I and R Registers
- Bit Tests
- Negation of Accumulator

The Z flag has no significance immediately after the following operations:

- Block Transfers

Other operations do not affect the zero flag.

8.4.8 Sign Flag (S)

The sign flag stores the state of bit 7 (the most-significant bit and sign bit) of the accumulator following an arithmetic operation. This flag is of use when dealing with signed numbers.

The sign flag is affected by the following operation according to the result:

- Adds (16-bit with carry, 8-bit with/without carry)
- Subtracts (16-bit with carry, 8-bit with/without carry)
- Logic Operations
- Increments and Decrements
- Rotate and Shifts
- Rotate Digits
- Decimal Adjust
- Input Register Indirect
- Block Search
- Load of I and R Registers
- Negation of Accumulator

The S flag has no significance immediately after the following operations:

- Block I/O
- Block Transfers
- Bit Tests

Other operations do not affect the sign bit.

8.4.9 Additional General-Purpose Registers

The other general-purpose registers are the B, C, D, E, H and L registers and their alternate register set, B', C', D', E', H' and L'. The general-purpose registers can be used interchangeably.

In addition, the B and C registers perform special functions in the NSC800 expanded I/O capabilities, particularly block I/O operations. In these functions, the C register can address I/O ports; the B register provides a counter function when used in the register indirect address mode.

When used with the special condition jump instruction (DJNZ) the B register again provides the counter function.

8.4.10 Alternate Configurations

The six 8-bit general purpose registers (B,C,D,E,H,L) will combine to form three 16-bit registers. This occurs by concatenating the B and C registers to form the BC register, the D and E registers form the DE register, and the H and L registers form the HL register.

Having these 16-bit registers allows 16-bit data handling, thereby expanding the number of 16-bit registers available for memory addressing modes. The HL register typically provides the pointer address for use in register indirect addressing of the memory.

The DE register provides a second memory pointer register for the NSC800's powerful block transfer operations. The BC register also provides an assist to the block transfer operations by acting as a byte-counter for these operations.

8.5 ARITHMETIC-LOGIC UNIT (ALU)

The arithmetic, logic and rotate instructions are performed by the ALU. The ALU internally communicates with the registers and data buffer on the 8-bit internal data bus.

8.6 INSTRUCTION REGISTER AND DECODER

During an opcode fetch, the first byte of an instruction is transferred from the data buffer (i.e. its on the internal data bus) to the instruction register. The instruction register feeds the instruction decoder, which gated by timing signals, generates the control signals that read or write data from or to the registers, control the ALU and provide all required external control signals.

9.0 Timing and Control

9.1 INTERNAL CLOCK GENERATOR

An inverter oscillator contained on the NSC800 chip provides all necessary timing signals. The chip operation frequency is equal to one half of the frequency of this oscillator.

The oscillator frequency can be controlled by one of the following methods:

1. Leaving the X_{OUT} pin unterminated and driving the X_{IN} pin with an externally generated clock as shown in Figure 6. When driving X_{IN} with a square wave, the minimum duty cycle is 30% high.

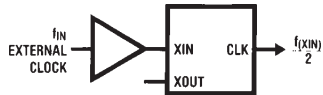

TL/C/5171-13

FIGURE 6. Use of External Clock

2. Connecting a crystal with the proper biasing network between X_{IN} and X_{OUT} as shown in Figure 7. Recommended crystal is a parallel resonance AT cut crystal.

Note 1: If the crystal frequency is between 1 MHz and 2 MHz a series resistor, R_S (470Ω to 1500Ω) should be connected between X_{OUT} and R, XTAL and C₂. Additionally, the capacitance of C₁ and C₂ should be increased by 2 to 3 times the recommended value. For crystal frequencies less than 1 MHz higher values of C₁ and C₂ may be required. Crystal parameters will also affect the capacitive loading requirements.

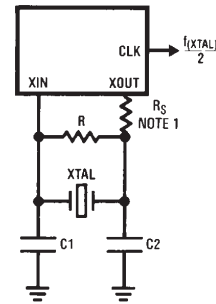

$$2 \text{ MHz} < \frac{f(\text{XTAL})}{2}$$

$$R = 1 \text{ M}\Omega$$

$$C_1 = 20 \text{ pF}$$

$$C_2 = 34 \text{ pF}$$

(Recommended)

TL/C/5171-14

FIGURE 7. Use Of Crystal

The CPU has a minimum clock frequency input (@ X_{IN}) of 300 kHz, which results in 150 kHz system clock speed. All registers internal to the chip are static, however there is dynamic logic which limits the minimum clock speed. The input clock can be stopped without fear of losing any data or damaging the part. You stop it in the phase of the clock that has X_{IN} low and CLK OUT high. When restarting the CPU, precautions must be taken so that the input clock meets these minimum specification. Once started, the CPU will continue operation from the same location at which it was stopped. During DC operation of the CPU, typical current drain will be 2 mA. This current drain can be reduced by placing the CPU in a wait state during an opcode fetch cycle then stopping the clock. For clock stop circuit, see Figure 8.

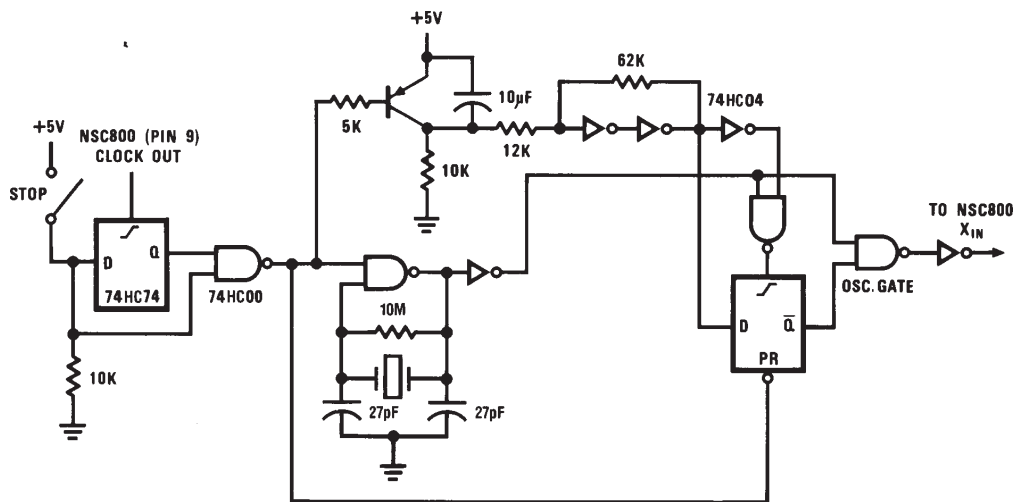

TL/C/5171-36

FIGURE 8. Clock Stop Circuit

9.0 Timing and Control (Continued)

9.2 CPU TIMING

The NSC800 uses a multiplexed bus for data and addresses. The 16-bit address bus is divided into a high-order 8-bit address bus that handles bits 8–15 of the address, and a low-order 8-bit multiplexed address/data bus that handles bits 0–7 of the address and bits 0–7 of the data. Strobe outputs from the NSC800 (ALE, \overline{RD} and \overline{WR}) indicate when a valid address or data is present on the bus. $\overline{IO/\overline{M}}$ indicates whether the ensuing cycle accesses memory or I/O.

During an input or output instruction, the CPU duplicates the lower half of the address [AD(0–7)] onto the upper address bus [A(8–15)]. The eight bits of address will stay on A(8–15) for the entire machine cycle and can be used for chip selection directly.

Figure 9 illustrates the timing relationship for opcode fetch cycles with and without a wait state.

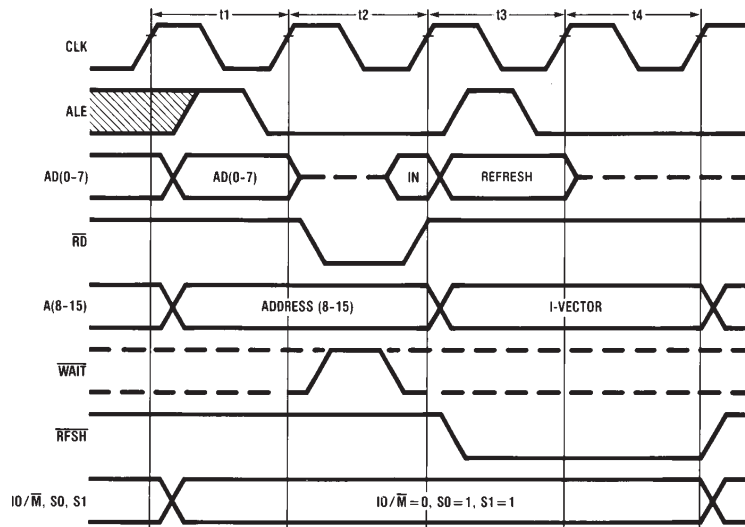

TL/C/5171-15

FIGURE 9a. Opcode Fetch Cycles without \overline{WAIT} States

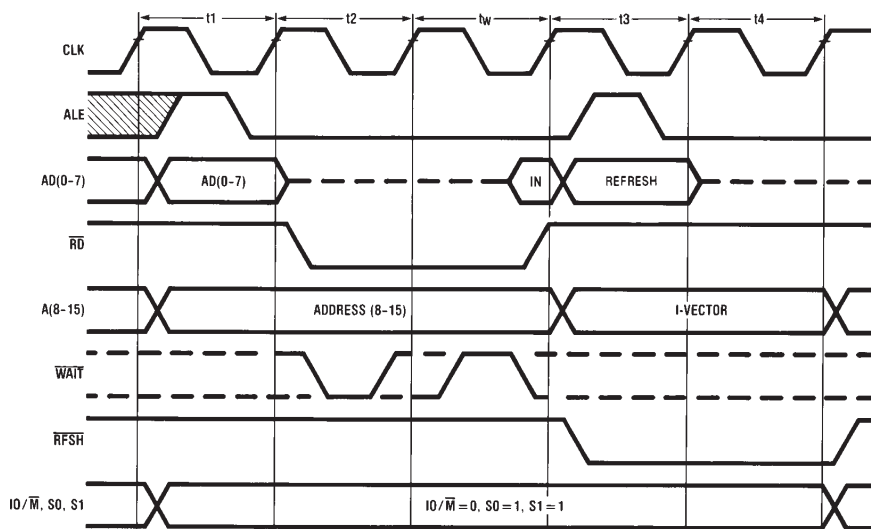

TL/C/5171-16

FIGURE 9b. Opcode Fetch Cycles with \overline{WAIT} States

9.0 Timing and Control (Continued)

During the opcode fetch, the CPU places the contents of the PC on the address bus. The falling edge of ALE indicates a valid address on the AD(0-7) lines. The $\overline{\text{WAIT}}$ input is sampled during t_2 and if active causes the NSC800 to insert a wait state (t_w). $\overline{\text{WAIT}}$ is sampled again during t_w so

that when it goes inactive, the CPU continues its opcode fetch by latching in the data on the rising edge of $\overline{\text{RD}}$ from the AD(0-7) lines. During t_3 , $\overline{\text{RFSH}}$ goes active and AD(0-7) has the dynamic RAM refresh address from register R and A(8-15) the interrupt vector from register I.

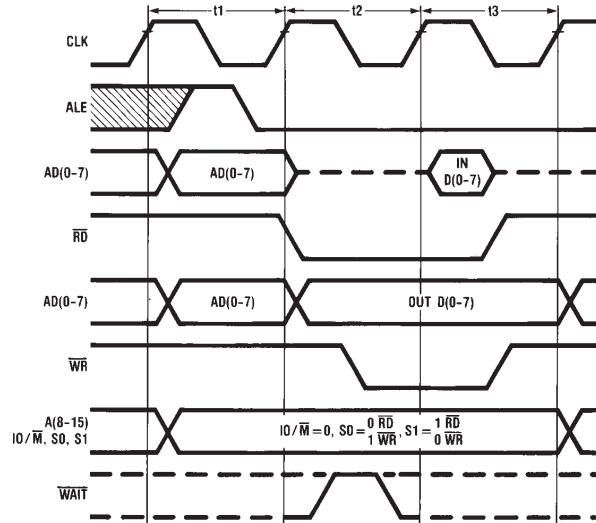

TL/C/5171-17

FIGURE 10a. Memory Read/Write Cycles without $\overline{\text{WAIT}}$ States

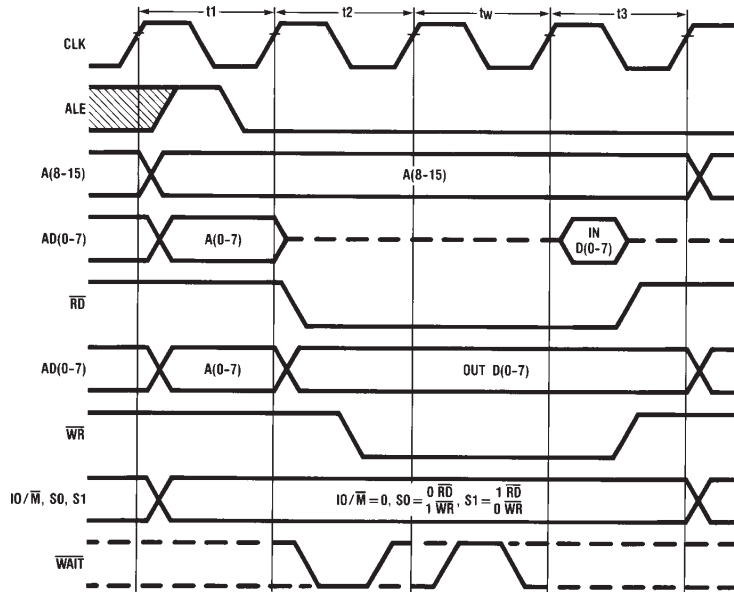

TL/C/5171-18

FIGURE 10b. Memory Read and Write with $\overline{\text{WAIT}}$ States

9.0 Timing and Control (Continued)

Figure 10 shows the timing for memory read (other than opcode fetches) and write cycles with and without a wait state. The \overline{RD} stobe is widened by $\frac{t}{2}$ (half the machine state) for memory reads so that the actual latching of the input data occurs later.

Figure 11 shows the timing for input and output cycles with and without wait states. The CPU automatically inserts one wait state into each I/O instruction to allow sufficient time for an I/O port to decode the address.

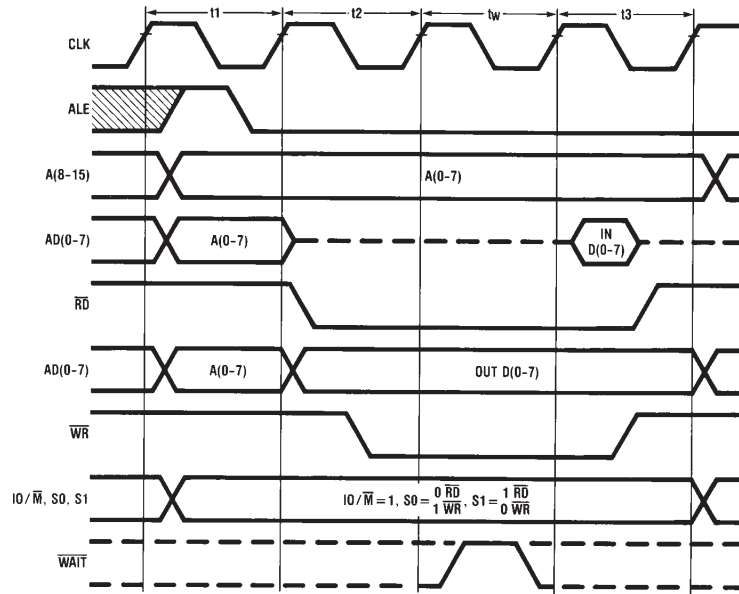

FIGURE 11a. Input and Output Cycles without WAIT States

TL/C/5171-19

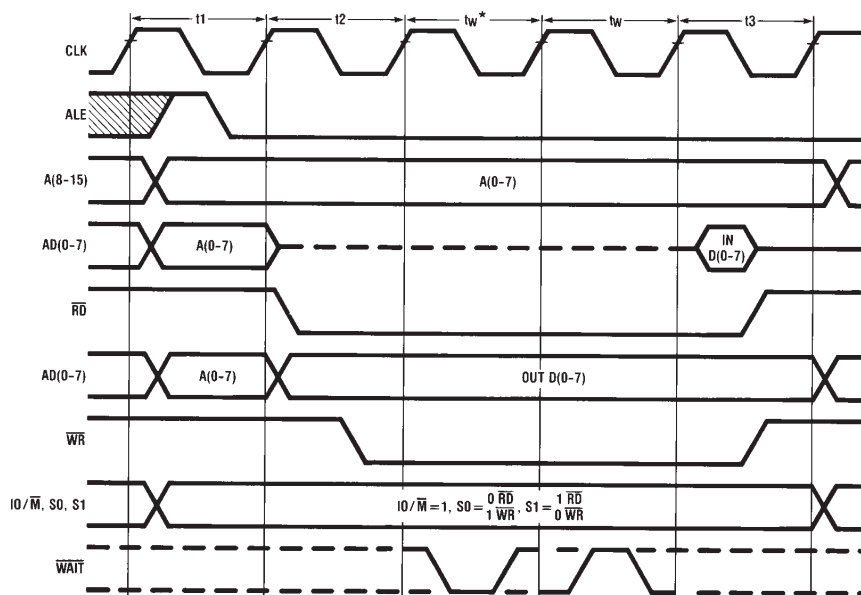

FIGURE 11b. Input and Output Cycles with WAIT States

TL/C/5171-20

*WAIT state automatically inserted during IO operation.

9.0 Timing and Control (Continued)

9.3 INITIALIZATION

$\overline{\text{RESET IN}}$ initializes the NSC800; RESET OUT initializes the peripheral components. The Schmitt trigger at the $\overline{\text{RESET IN}}$ input facilitates using an R-C network reset scheme during power up (see Figure 12).

To ensure proper power-up conditions for the NSC800, the following power-up and initialization procedure is recommended:

1. Apply power (V_{CC} and GND) and set $\overline{\text{RESET IN}}$ active (low). Allow sufficient time (approximately 30 ms if a crystal is used) for the oscillator and internal clocks to stabilize. $\overline{\text{RESET IN}}$ must remain low for at least 3t state (CLK) times. RESET OUT goes high as soon as the active $\overline{\text{RESET IN}}$ signal is clocked into the first flip-flop after the on-chip Schmitt trigger. RESET OUT signal is available to reset the peripherals.
2. Set $\overline{\text{RESET IN}}$ high. RESET OUT then goes low as the inactive $\overline{\text{RESET IN}}$ signal is clocked into the first flip-flop after the on-chip Schmitt trigger. Following this the CPU initiates the first opcode fetch cycle.

Note: The NSC800 initialization includes: Clear PC to X'0000 (the first opcode fetch, therefore, is from memory location X'0000). Clear registers I (Interrupt Vector Base) and R (Refresh Counter) to X'00. Clear interrupt control register bits IEA, IEB and IEC. The interrupt control bit IEI is set to 1 to maintain INS8080A/Z80A compatibility (see INTERRUPTS for more details). The CPU disables maskable interrupts and enters $\overline{\text{INTR}}$ Mode 0. While $\overline{\text{RESET IN}}$ is active (low), the A(8–15) and AD(0–7) lines go to high impedance (TRI-STATE) and all CPU strobes go to the inactive state (see Figure 13).

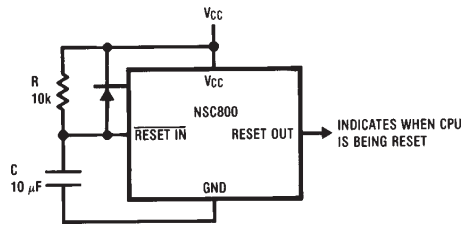

FIGURE 12. Power-On Reset

TL/C/5171-21

9.4 POWER-SAVE FEATURE

The NSC800 provides a unique power-save mode by the means of the $\overline{\text{PS}}$ pin. $\overline{\text{PS}}$ input is sampled at the last t state of the last M cycle of an instruction. After recognizing an active (low) level on $\overline{\text{PS}}$, The NSC800 stops its internal clocks, thereby reducing its power dissipation to one half of operating power, yet maintaining all register values and internal control status. The NSC800 keeps its oscillator running, and makes the CLK signal available to the system. When in power-save the ALE strobe will be stopped high and the address lines [AD(0–7), A(8–15)] will indicate the next machine address. When $\overline{\text{PS}}$ returns high, the opcode fetch (or M1 cycle) of the CPU begins in a normal manner. Note this M1 cycle could also be an interrupt acknowledge cycle if the NSC800 was interrupted simultaneously with $\overline{\text{PS}}$ (i.e. $\overline{\text{PS}}$ has priority over a simultaneously occurring interrupt). However, interrupts are not accepted during power save. Figure 14 illustrates the power save timing.

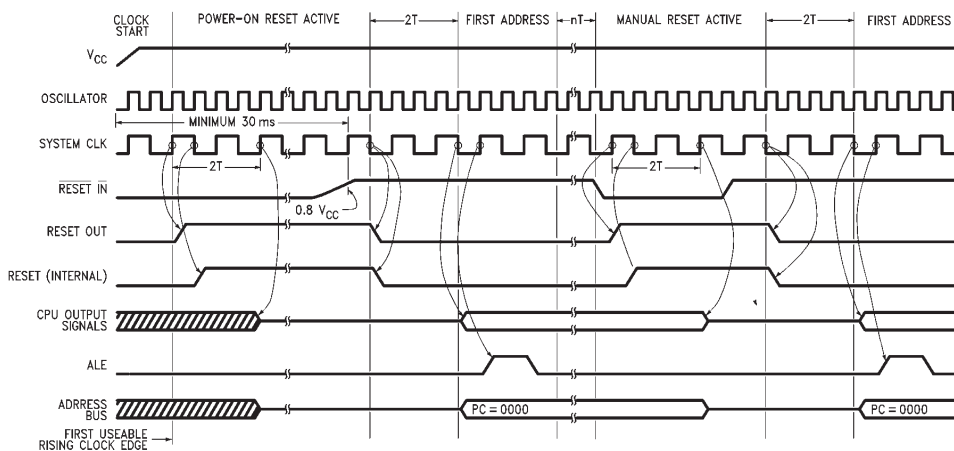

FIGURE 13. NSC800 Signals During Power-On and Manual Reset

TL/C/5171-74

9.0 Timing and Control (Continued)

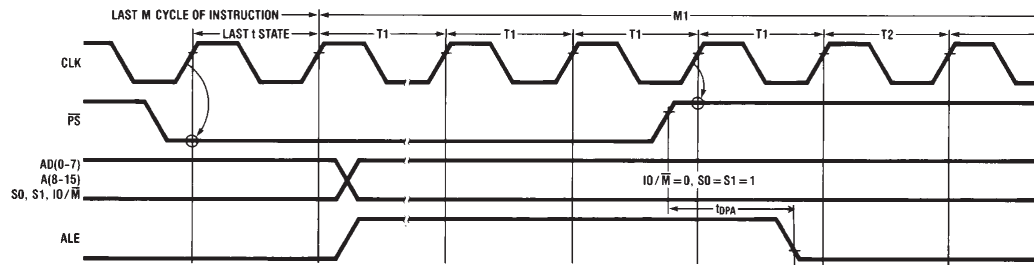
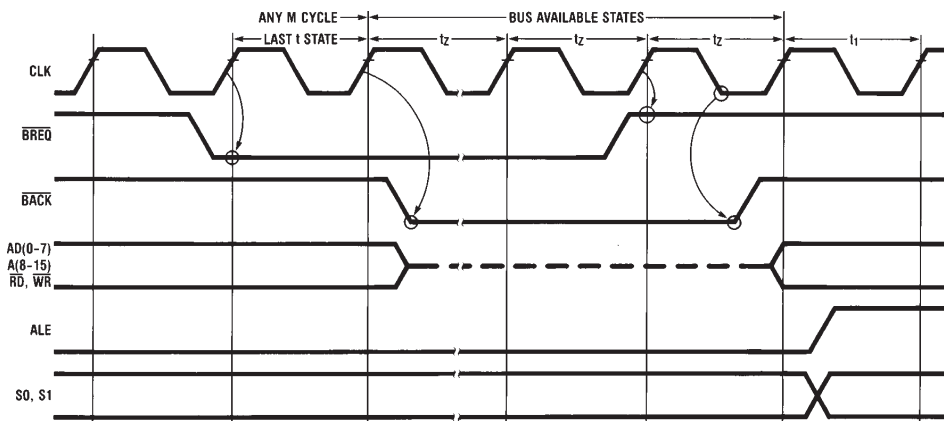

FIGURE 14. NSC800 Power-Save

TL/C/5171-28



TL/C/5171-22

*S0, S1 during \overline{BREQ} will indicate same machine cycle as during the cycle when \overline{BREQ} was accepted.

t_z = time states during which bus and control signals are in high impedance mode.

FIGURE 15. Bus Acknowledge Cycle

In the event \overline{BREQ} is asserted (low) at the end of an instruction cycle and \overline{PS} is active simultaneously, the following occurs:

1. The NSC800 will go into \overline{BACK} cycle.
2. Upon completion of \overline{BACK} cycle if \overline{PS} is still active the CPU will go into power-save mode.

9.5 BUS ACCESS CONTROL

Figure 15 illustrates bus access control in the NSC800. The external device controller produces an active \overline{BREQ} signal that requests the bus. When the CPU responds with \overline{BACK} then the bus and related control strobes go to high impedance (TRI-STATE) and the \overline{RFSH} signal remains high. It should be noted that (1) \overline{BREQ} is sampled at the last t state of any M machine cycle only. (2) The NSC800 will not acknowledge any interrupt/restart requests, and will not perform any dynamic RAM refresh functions until after \overline{BREQ} input signal is inactive high. (3) \overline{BREQ} signal has priority over all interrupt request signals, should \overline{BREQ} and interrupt request become active simultaneously. Therefore, interrupts latched at the end of the instruction cycle will be serviced after a simultaneously occurring \overline{BREQ} . \overline{NMI} is latched during an active \overline{BREQ} .

9.6 INTERRUPT CONTROL

The NSC800 has five interrupt/restart inputs, four are maskable (\overline{RSTA} , \overline{RSTB} , \overline{RSTC} , and \overline{INTR}) and one is non-maskable (\overline{NMI}). \overline{NMI} has the highest priority of all interrupts; the user cannot disable \overline{NMI} . After recognizing an active input on \overline{NMI} , the CPU stops before the next instruction, pushes the PC onto the stack, and jumps to address X'0066, where the user's interrupt service routine is located (i.e., restart to memory location X'0066). \overline{NMI} is intended for interrupts requiring immediate attention, such as power-down, control panel, etc.

\overline{RSTA} , \overline{RSTB} and \overline{RSTC} are restart inputs, which, if enabled, execute a restart to memory location X'003C, X'0034, and X'002C, respectively. Note that the CPU response to the \overline{NMI} and \overline{RST} (\overline{A} , \overline{B} , \overline{C}) request input is basically identical, except for the restored memory location. Unlike \overline{NMI} , however, restart request inputs must be enabled.

Figure 16 illustrates \overline{NMI} and \overline{RST} interrupt machine cycles. M1 cycle will be a dummy opcode fetch cycle followed by M2 and M3 which are stack push operations. The following instruction then starts from the interrupts restart location.

Note: \overline{RD} does not go low during this dummy opcode fetch. A unique indication of \overline{INTA} can be decoded using 2 ALEs and \overline{RD} .

9.0 Timing and Control (Continued)

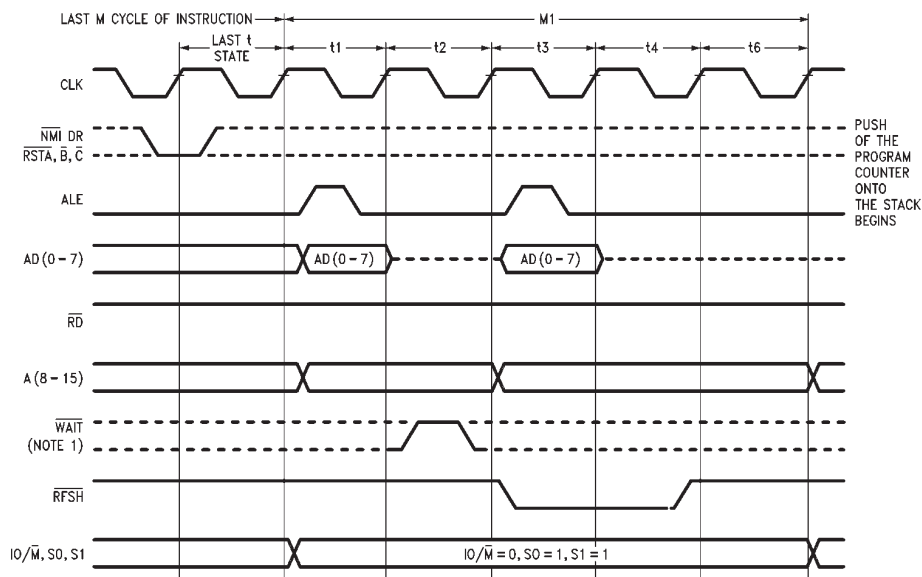

TL/C/5171-24

Note 1: This is the only machine cycle that does not have an \overline{RD} , \overline{WR} , or \overline{INTA} strobe but will accept a wait strobe.

FIGURE 16. Non-Maskable and Restart Interrupt Machine Cycle

The NSC800 also provides one more general purpose interrupt request input, \overline{INTR} . When enabled, the CPU responds to \overline{INTR} in one of the three modes defined by instruction IMO, IM1, and IM2 for modes 0, 1, and 2, respectively. Following reset, the CPU automatically enables mode 0.

Interrupt (\overline{INTR}) Mode 0: The CPU responds to an interrupt request by providing an \overline{INTA} (interrupt acknowledge) strobe, which can be used to gate an instruction from a peripheral onto the data bus. The CPU inserts two wait states during the first \overline{INTA} cycle to allow the interrupting device (or its controller) ample time to gate the instruction and determine external priorities (Figure 18). This can be any instruction from one to four bytes. The most popular instruction is one-byte call (restart instruction) or a three-byte call (CALL NN instruction). If it is a three-byte call, the CPU issues a total of three \overline{INTA} strobes. The last two (which do not include wait states) read NN.

Note: If the instruction stored in the ICU doesn't require the PC to be pushed onto the stack (eq. JP nn), then the PC will not be pushed.

Interrupt (\overline{INTR}) Mode 1: Similar to restart interrupts except the restart location is X'0038 (Figure 18).

Interrupt (\overline{INTR}) Mode 2: With this mode, the programmer maintains a table that contains the 16-bit starting address of every interrupt service routine. This table can be located anywhere in memory. When the CPU accepts a Mode 2 interrupt (Figure 17), it forms a 16-bit pointer to obtain the desired interrupt service routine starting address from the table. The upper 8 bits of this pointer are from the contents of the I register. The lower 8 bits of the pointer are supplied by the interrupting device with the LSB forced to zero. The programmer must load the interrupt vector prior to the interrupt occurring. The CPU uses the pointer to get the two adjacent bytes from the interrupt service routine starting address table to complete 16-bit service routine starting address.

dress. The first byte of each entry in the table is the least significant (low-order) portion of the address. The programmer must obviously fill this table with the desired addresses before any interrupts are to be accepted.

Note that the programmer can change this table at any time to allow peripherals to be serviced by different service routines. Once the interrupting device supplies the lower portion of the pointer, the CPU automatically pushes the program counter onto the stack, obtains the starting address from the table and does a jump to this address.

The interrupts have fixed priorities built into the NSC800 as:

\overline{NMI}	0066	(Highest Priority)
\overline{RSTA}	003C	
\overline{RSTB}	0034	
\overline{RSTC}	002C	
\overline{INTR}	0038	(Lowest Priority)

Interrupt Enable, Interrupt Disable. The NSC800 has two types of interrupt inputs, a non-maskable interrupt and four software maskable interrupts. The non-maskable interrupt (\overline{NMI}) cannot be disabled by the programmer and will be accepted whenever a peripheral device requests an interrupt. The \overline{NMI} is usually reserved for important functions that must be serviced when they occur, such as imminent power failure. The programmer can selectively enable or disable maskable interrupts (\overline{INT} , \overline{RSTA} , \overline{RSTB} and \overline{RSTC}). This selectivity allows the programmer to disable the maskable interrupts during periods when timing constraints don't allow program interruption.

There are two interrupt enable flip-flops (IFF_1 and IFF_2) on the NSC800. Two instructions control these flip-flops. Enable Interrupt (EI) and Disable Interrupt (DI). The state of IFF_1 determines the enabling or disabling of the maskable interrupts, while IFF_2 is used as a temporary storage location for the state of IFF_1 .

9.0 Timing and Control (Continued)

A reset to the CPU will force both IFF₁ and IFF₂ to the reset state disabling maskable interrupts. They can be enabled by an EI instruction at any time by the programmer. When an EI instruction is executed, any pending interrupt requests will not be accepted until after the instruction following EI has been executed. This single instruction delay is necessary in situations where the following instruction is a return instruction and interrupts must not be allowed until the return has been completed. The EI instruction sets both IFF₁ and IFF₂

to the enable state. When the CPU accepts an interrupt, both IFF₁ and IFF₂ are automatically reset, inhibiting further interrupts until the programmer wishes to issue a new EI instruction. Note that for all the previous cases, IFF₁ and IFF₂ are always equal.

The function of IFF₂ is to retain the status of IFF₁ when a non-maskable interrupt occurs. When a non-maskable interrupt is accepted, IFF₁ is reset to prevent further interrupts until reenabled by the programmer. Thus, after a non-maskable interrupt has been accepted, maskable interrupts are disabled but the previous state of IFF₁ is saved by IFF₂

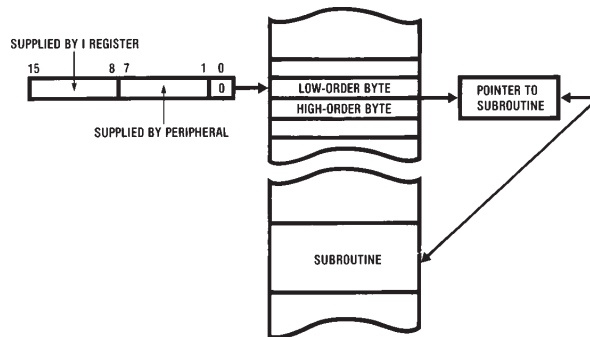
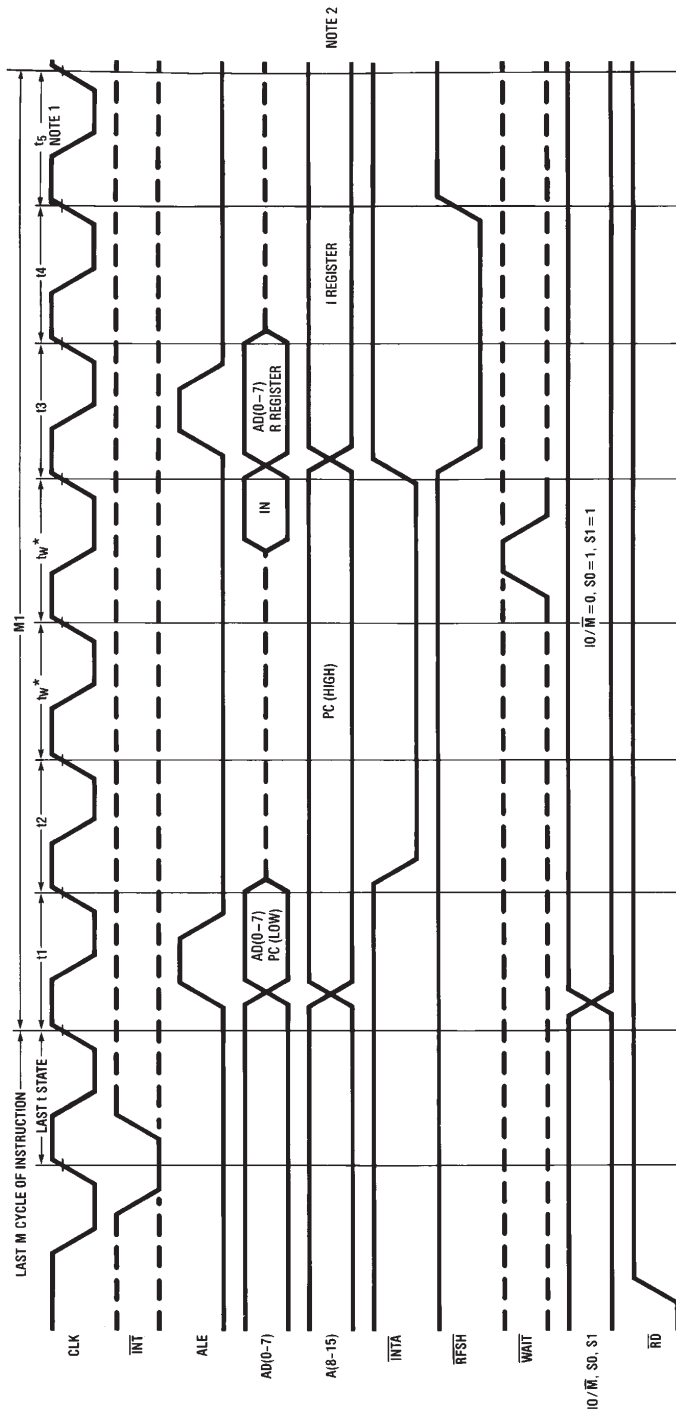

FIGURE 17. Interrupt Mode 2

TL/C/5171-27

9.0 Timing and Control (Continued)



TL/C/5171-25

*tw is the CPU generated WAIT state in response to an interrupt request.

Note 1: t5 will only occur in mode 1 and mode 2. During t5 the stack pointer is decremented.

Note 2: A jump to the appropriate address occurs here in mode 1 and mode 2. The CPU continues gathering data from the interrupting peripheral in mode 0 for a total of 2-4 machine cycles. In mode 0 cycles M2-M4 have only 1 wait state.

FIGURE 18. Interrupt Acknowledge Machine Cycle

9.0 Timing and Control (Continued)

so that the complete state of the CPU just prior to the non-maskable interrupt may be restored. The method of restoring the status of IFF₁ is through the execution of a Return Non-Maskable Interrupt (RETN) instruction. Since this instruction indicates that the non-maskable interrupt service routine is completed, the contents of IFF₂ are now copied back into IFF₁, so that the status of IFF₁ just prior to the acceptance of the non-maskable interrupt will be automatically restored.

Figure 19 depicts the status of the flip flops during a sample series of interrupt instructions.

Interrupt Control Register. The interrupt control register (ICR) is a 4-bit, write only register that provides the programmer with a second level of maskable control over the four maskable interrupt inputs.

The ICR is internal to the NSC800 CPU, but is addressed through the I/O space at I/O address port X'BB. Each bit in the register controls a mask bit dedicated to each maskable interrupt, \overline{RSTA} , \overline{RSTB} , \overline{RSTC} and \overline{INTR} . For an interrupt request to be accepted on any of these inputs, the corresponding mask bit in the ICR must be set (= 1) and IFF₁ and IFF₂ must be set. This provides the programmer with control over individual interrupt inputs rather than just a system wide enable or disable.

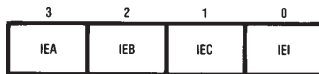

TL/C/5171-26

Bit	Name	Function
0	IEI	Interrupt Enable for \overline{INTR}
1	IEC	Interrupt Enable for \overline{RSTC}
2	IEB	Interrupt Enable for \overline{RSTB}
3	IEA	Interrupt Enable for \overline{RSTA}

For example: In order to enable \overline{RSTB} , CPU interrupts must be enabled and IEB must be set.

At reset, IEI bit is set and other mask bits IEA, IEB, IEC are cleared. This maintains the software compatibility between NSC800 and Z80A.

Execution of an I/O block move instruction will not affect the state of the interrupt control bits. The only two instructions that will modify this write only register are OUT (C), r and OUT (N), A.

Operation	IFF ₁	IFF ₂	Comment
Initialize	0	0	Interrupt Disabled
•			
•			
•			
EI	1	1	Interrupt Enabled after next instruction
•			
•			
\overline{INTR}	0	0	Interrupt Disable and \overline{INTR} Being Serviced
•			
•			
•			
EI	1	1	Interrupt Enabled after next instruction
RET	1	1	Interrupt Enabled
•			
•			
•			
\overline{NMI}	0	1	Interrupt Disabled
•			
•			
•			
RETN	1	1	Interrupt Enabled
•			
\overline{INTR}	0	0	Interrupt Disabled
•			
•			
•			
\overline{NMI}	0	0	Interrupt Disabled and \overline{NMI} Being Serviced
•			
•			
•			
RETN	0	0	Interrupt Disabled and \overline{INTR} Being Serviced
•			
•			
•			
EI	1	1	Interrupt Enabled after next instruction
RET	1	1	Interrupt Enabled
•			
•			
•			

FIGURE 19. IFF₁ and IFF₂ States Immediately after the Operation has been Completed

NSC800 SOFTWARE

10.0 Introduction

This chapter provides the reader with a detailed description of the NSC800 software. Each NSC800 instruction is described in terms of opcode, function, flags affected, timing, and addressing mode.

11.0 Addressing Modes

The following sections describe the addressing modes supported by the NSC800. Note that particular addressing modes are often restricted to certain types of instructions. Examples of instructions used in the particular addressing modes follow each mode description.

The 10 addressing modes and 158 instructions provide a flexible and powerful instruction set.

11.1 REGISTER

The most basic addressing mode is that which addresses data in the various CPU registers. In these cases, bits in the opcode select specific registers that are to be addressed by the instruction.

Example:

Instruction: Load register B from register C

Mnemonic: LD B,C

Opcode:

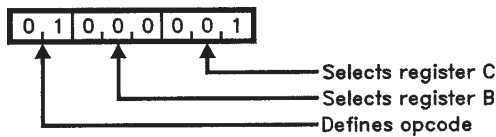

In this instruction, both the B and C registers are addressed by opcode bits.

11.2 IMPLIED

The implied addressing mode is an extension to the register addressing mode. In this mode, a specific register, the accumulator, is used in the execution of the instruction. In particular, arithmetic operations employ implied addressing, since the A register is assumed to be the destination register for the result without being specifically referenced in the opcode.

Example:

Instruction: Subtract the contents of register D from the Accumulator (A register)

Mnemonic: SUB D

Opcode:

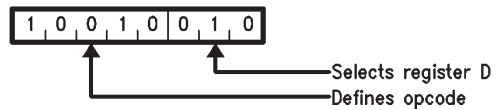

In this instruction, the D register is addressed with register addressing, while the use of the A register is implied by the opcode.

11.3 IMMEDIATE

The most straightforward way of introducing data to the CPU registers is via immediate addressing, where the data is contained in an additional byte of multi-byte instructions.

Example:

Instruction: Load the E register with the constant value X'7C.

Mnemonic: LD E,X'7C

Opcode:

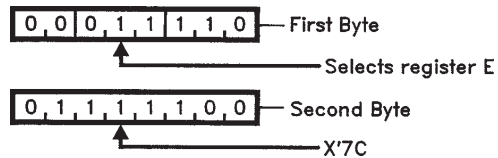

In this instruction, the E register is addressed with register addressing, while the constant X'7C is immediate data in the second byte of the instruction.

11.4 IMMEDIATE EXTENDED

As immediate addressing allows 8 bits of data to be supplied by the operand, immediate extended addressing allows 16 bits of data to be supplied by the operand. These are in two additional bytes of the instruction.

Example:

Instruction: Load the 16-bit IX register with the constant value X'ABCD.

Mnemonic: LD IX,X'ABCD

Opcode:

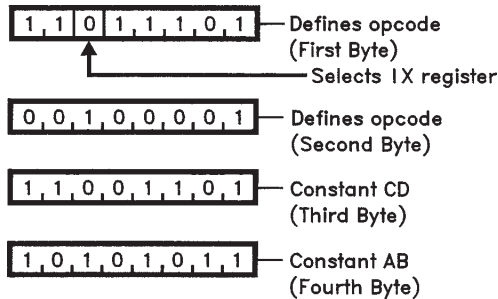

In this instruction, register addressing selects the IX register, while the 16-bit quantity X'ABCD is immediate data supplied as immediate extended format.

11.0 Addressing Modes (Continued)

11.5 DIRECT ADDRESSING

Direct addressing is the most straightforward way of addressing supplies a location in the memory space. Direct addressing, 16-bits of memory address information in two bytes of data as part of the instruction. The memory address could be either data, source of destination, or a location for program execution, as in program control instructions.

Example:

Instruction: Jump to location X'0377

Mnemonic: JP X'0377

Opcode:

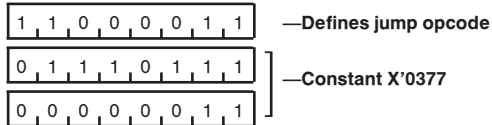

This instruction loads the Program Counter (PC) is loaded with the constant in the second and third bytes of the instruction. The program counter contents are transferred via direct addressing.

11.6 REGISTER INDIRECT

Next to direct addressing, register indirect addressing provides the second most straightforward means of addressing memory. In register indirect addressing, a specified register pair contains the address of the desired memory location. The instruction references the register pair and the register contents define the memory location of the operand.

Example:

Instruction: Add the contents of memory location X'0254 to the A register. The HL register contains X'0254.

Mnemonic: ADD A,(HL)

Opcode:

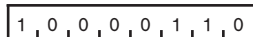

This instruction uses implied addressing of the A and HL registers and register indirect addressing to access the data pointed to by the HL register.

11.7 INDEXED

The most flexible mode of memory addressing is the indexed mode. This is similar to the register indirect mode of addressing because one of the two index registers (IX or IY) contains the base memory address. In addition, a byte of data included in the instruction acts as a displacement to the address in the index register.

Indexed addressing is particularly useful in dealing with lists of data.

Example:

Instruction: Increment the data in memory location X'1020.

The IY register contains X'1000.

Mnemonic: INC (IY+X'20)

Opcode:

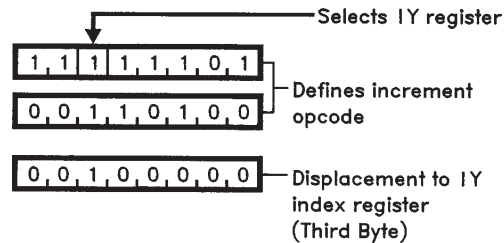

TL/C/5171-54

The indexed addressing mode uses the contents of index registers IX or IY along with the displacement to form a pointer to memory.

11.8 RELATIVE

Certain instructions allow memory locations to be addressed as a position relative to the PC register. These instructions allow jumps to memory locations which are offsets around the program counter. The offset, together with the current program location, is determined through a displacement byte included in the instruction. The formation of this displacement byte is explained more fully in the "Instructions Set" section.

Example:

Instruction: Jump to a memory location 7 bytes beyond the current location.

Mnemonic: JR \$+7

Opcode:

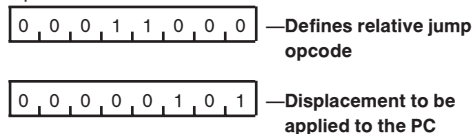

The program will continue at a location seven locations past the current PC.

11.0 Addressing Modes (Continued)

11.9 MODIFIED PAGE ZERO

A subset of NSC800 instructions (the Restart instructions) provides a code-efficient single-byte instruction that allows CALLs to be performed to any one of eight dedicated locations in page zero (locations X'0000 to X'00FF). Normally, a CALL is a 3-byte instruction employing direct memory addressing.

Example:

Instruction: Perform a restart call to location X'0028.

Mnemonic: RST X'28

Opcode:

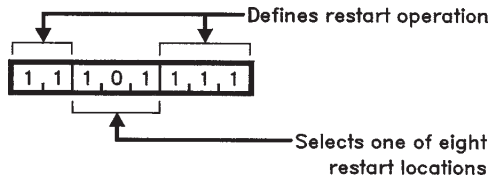

TL/C/5171-55

p	00H	08H	10H	18H	20H	28H	30H	38H
t	000	001	010	011	100	101	110	111

Program execution continues at location X'0028 after execution of a single-byte call employing modified page zero addressing.

11.10 BIT

The NSC800 allows setting, resetting, and testing of individual bits in registers and memory data bytes.

Example:

Operation: Set bit 2 in the L register

Mnemonic: SET 2,L

Opcode:

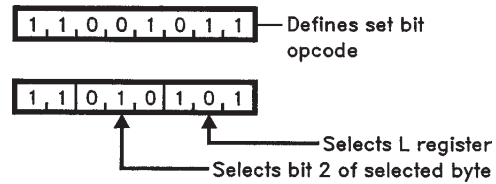

TL/C/5171-56

Bit addressing allows the selection of bit 2 in the L register selected by register addressing.

12.0 Instruction Set

This section details the entire NSC800 instruction set in terms of

- Opcode
- Instruction
- Function
- Timing
- Addressing Mode

The instructions are grouped in order under the following functional headings:

- 8-Bit Loads
- 16-Bit Loads
- 8-Bit Arithmetic
- 16-Bit Arithmetic
- Bit Set, Reset, and Test
- Rotate and Shift
- Exchanges
- Memory Block Moves and Searches
- Input/Output
- CPU Control
- Program Control

12.1 Instruction Set Index

Alphabetical Assembly Mnemonic	Operation	Page
ADC A,m ₁	Add, with carry, memory location contents to Accumulator	40
ADC A,n	Add, with carry, immediate data n to Accumulator	38
ADC A,r	Add, with carry, register r contents to Accumulator	36
ADC HL,pp	Add, with carry, register pair pp to HL	43
ADD A,m ₁	Add memory location contents to Accumulator	40
ADD A,n	Add immediate data n to Accumulator	38
ADD A,r	Add register r contents to Accumulator	36
ADD HL,pp	Add register pair pp to HL	43
ADD IX,pp	Add register pair pp to IX	43
ADD IY,pp	Add register pair pp to IY	43
ADD ss,pp	Add register pair pp to contents of register pair ss	43
AND m ₁	Logical 'AND' memory contents to Accumulator	41
AND n	Logical 'AND' immediate data to Accumulator	39
AND r	Logical 'AND' register r contents to Accumulator	36
BIT b,m ₁	Test bit b of location m ₁	45
BIT b,r	Test bit b of register r	44
CALL cc,nn	Call subroutine at location nn if condition cc is true	56
CALL nn	Unconditional call to subroutine at location nn	56
CCF	Complement carry flag	38
CP m ₁	Compare memory contents with Accumulator	42
CP n	Compare immediate data n with Accumulator	40
CP r	Compare register r to contents with Accumulator	37
CPD	Compare location (HL) and Accumulator, decrement HL and BC	50
CPDR	Compare location (HL) and Accumulator, decrement HL and BC; repeat until BC = 0	51
CPI	Compare location (HL) and Accumulator, increment HL, decrement BC	50
CPIR	Compare location (HL) and Accumulator, increment HL, decrement BC; repeat until BC = 0	51
CPL	Complement Accumulator (1's complement)	37
DAA	Decimal adjust Accumulator	38
DEC m ₁	Decrement data in memory location m ₁	42
DEC r	Decrement register r contents	37
DEC rr	Decrement register pair rr contents	44

12.1 Instruction Set Index (Continued)

Alphabetical Assembly Mnemonic	Operation	Page
DI	Disable interrupts	54
DJNZ,d	Decrement B and jump relative B \neq 0	56
EI	Enable interrupts	54
EX (SP),ss	Exchange the location (SP) with register ss	50
EX AF,A'F'	Exchange the contents of AF and A'F'	49
EX DE,HL	Exchange the contents of DE and HL	49
EXX	Exchange the contents of BC, DE and HL with the contents of B'C, D'E' and H'L', respectively	50
HALT	Halt (wait for interrupt or reset)	54
IM 0	Set interrupt mode 0	54
IM 1	Set interrupt mode 1	55
IM 2	Set interrupt mode 2	55
IN A,(n)	Load Accumulator with input from device (n)	52
IN r,(C)	Load register r with input from device (C)	52
INC m ₁	Increment data in memory location m ₁	42
INC r	Increment register r	37
INC rr	Increment contents of register pair rr	43
IND	Load location (HL) with input from port (C), decrement HL and B	52
INDR	Load location (HL) with input from port (C), decrement HL and B; repeat until B = 0	54
INI	Load location (HL) with input from port (C), increment HL, decrement B	52
INIR	Load location (HL) with input from port (C), increment HL, decrement B; repeat until B = 0	53
JP cc,nn	Jump to location nn, if condition cc is true	55
JP nn	Unconditional jump to location nn	55
JP (ss)	Unconditional jump to location (ss)	55
JR d	Unconditional jump relative to PC + d	55
JR kk,d	Jump relative to PC + d, if kk true	55
LD A,I	Load Accumulator with register I contents	32
LD A,m ₂	Load Accumulator from location m ₂	33
LD A,R	Load Accumulator with register R contents	32
LD I,A	Load register I with Accumulator contents	32
LD m ₁ ,n	Load memory with immediate data n	33
LD m ₁ ,r	Load memory from register r	32
LD m ₂ ,A	Load memory from Accumulator	33
LD (nn),rr	Load memory location nn with register pair rr	34
LD r,m ₁	Load register r from memory	33
LD r,n	Load register with immediate data n	32
LD R,A	Load register R from Accumulator	32
LD r _d ,r _s	Load destination register r _d from source register r _s	32
LD rr,(nn)	Load register pair rr from memory location nn	35
LD rr,nn	Load register pair rr with immediate data nn	34
LD SP,ss	Load SP from register pair ss	34
LDD	Load location (DE) with location (HL), decrement DE, HL and BC	50
LDDR	Load location (DE) with location (HL), decrement DE, HL and BC; repeat until BC = 0	51
LDI	Load location (DE) with location (HL), increment DE and HL, decrement BC	50
LDIR	Load location (DE) with location (HL), increment DE and HL, decrement BC; repeat until BC = 0	51
NEG	Negate Accumulator (2's complement)	38
NOP	No operation	54

12.1 Instruction Set Index (Continued)

Alphabetical Assembly Mnemonic	Operation	Page
OR m ₁	Logical 'OR' of memory location contents and accumulator	41
OR n	Logical 'OR' of immediate data n and Accumulator	39
OR r	Logical 'OR' of register r and Accumulator	37
OTDR	Load output port (C) with location (HL), decrement HL and B; repeat until B = 0	54
OTIR	Load output port (C) with location (HL), increment HL, decrement B; repeat until B = 0	53
OUT (C),r	Load output port (C) with register r	52
OUT (n),A	Load output port (n) with Accumulator	53
OUTD	Load output port (C) with location (HL), decrement HL and B	53
OUTI	Load output port (C) with location (HL), increment HL, decrement B	52
POP qq	Load register pair qq with top of stack	35
PUSH qq	Load top of stack with register pair qq	35
RES b,m ₁	Reset bit b of memory location m ₁	44
RES b,r	Reset bit b of register r	44
RET	Unconditional return from subroutine	56
RET cc	Return from subroutine, if cc true	56
RETI	Unconditional return from interrupt	56
RETN	Unconditional return from non-maskable interrupt	57
RL m ₁	Rotate memory contents left through carry	47
RL r	Rotate register r left through carry	45
RLA	Rotate Accumulator left through carry	45
RLC m ₁	Rotate memory contents left circular	47
RLC r	Rotate register r left circular	45
RLCA	Rotate Accumulator left circular	45
RLD	Rotate digit left and right between Accumulator and memory (HL)	49
RR m ₁	Rotate memory contents right through carry	48
RR r	Rotate register r right through carry	46
RRA	Rotate Accumulator right through carry	48
RRC m ₁	Rotate memory contents right circular	47
RRC r	Rotate register r right circular	45
RRCA	Rotate Accumulator right circular	46
RRD	Rotate digit right and left between Accumulator and memory (HL)	49
RST P	Restart to location P	57
SBC A,m ₁	Subtract, with carry, memory contents from Accumulator	41
SBC A,n	Subtract, with carry, immediate data n from Accumulator	39
SBC A,r	Subtract, with carry, register r from Accumulator	36
SBC HL,pp	Subtract, with carry, register pair pp from HL	43
SCF	Set carry flag	38
SET b,m ₁	Set bit b in memory location m ₁ contents	44
SET b,r	Set bit b in register r	44
SLA m ₁	Shift memory contents left, arithmetic	48
SLA r	Shift register r left, arithmetic	46
SRA m ₁	Shift memory contents right, arithmetic	48
SRA r	Shift register r right, arithmetic	46
SRL m ₁	Shift memory contents right, logical	48
SRL r	Shift register r right, logical	46
SUB m ₁	Subtract memory contents from Accumulator	40
SUB n	Subtract immediate data n from Accumulator	39
SUB r	Subtract register r from Accumulator	36
XOR m ₁	Exclusive 'OR' memory contents and Accumulator	42
XOR n	Exclusive 'OR' immediate data n and Accumulator	39
XOR r	Exclusive 'OR' register r and Accumulator	37

12.0 Instruction Set (Continued)

12.2 INSTRUCTION SET MNEMONIC NOTATION

In the following instruction set listing, the notations used are shown below.

- b: Designates one bit in a register or memory location. Bit address mode uses this indicator.
- cc: Designates condition codes used in conditional Jumps, Calls, and Return instruction; may be:
 NZ = Non-Zero (Z flag=0)
 Z = Zero (Z flag=1)
 NC = Non-Carry (C flag=0)
 C = Carry (C flag=1)
 PO = Parity Odd or No Overflow (P/V=0)
 PE = Parity Even or Overflow (P/V=1)
 P = Positive (S=0)
 M = Negative (S=1)
- d: Designates an 8-bit signed complement displacement. Relative or indexed address modes use this indicator.
- kk: Subset of cc condition codes used in conjunction with conditional relative jumps; may be NZ, Z, NC or C.
- m₁: Designates (HL), (IX+d) or (IY+d). Register indirect or indexed address modes use this indicator.
- m₂: Designates (BC), (DE) or (nn). Register indirect or direct address modes use this indicator.
- n: Any 8-bit binary number.
- nn: Any 16-bit binary number.
- p: Designates restart vectors and may be the hex values 0, 8, 10, 18, 20, 28, 30 or 38. Restart instructions employing the modified page zero addressing mode use this indicator.
- pp: Designates the BC, DE, SP or any 16-bit register used as a destination operand in 16-bit arithmetic operations employing the register address mode.
- qq: Designates BC, DE, HL, A, F, IX, or IY during operations employing register address mode.
- r: Designates A, B, C, D, E, H or L. Register addressing modes use this indicator.
- rr: Designates BC, DE, HL, SP, IX or IY. Register addressing modes use this indicator.
- ss: Designates HL, IX or IY. Register addressing modes use this indicator.
- X_L: Subscript L indicates the lower-order byte of a 16-bit register.
- X_H: Subscript H indicates the high-order byte of a 16-bit register.
- (): parentheses indicate the contents are considered a pointer address to a memory or I/O location.

12.3 ASSEMBLED OBJECT CODE NOTATION

Register Codes:

r	Register	rp	Register	rs	Register
000	B	00	BC	00	BC
001	C	01	DE	01	DE
010	D	10	HL	10	HL
011	E	11	SP	11	AF
100	H	pp	Register	qq	Register
101	L	00	BC	00	BC
111	A	01	DE	01	DE
		10	IX	10	HL
		11	SP	11	AF

Conditions Codes:

cc	Mnemonic	True Flag Condition
000	NZ	Z=0
001	Z	Z=1
010	NC	C=0
011	C	C=1
100	PO	P/V=0
101	PE	P/V=1
110	P	S=0
111	M	S=1
kk	Mnemonic	True Flag Condition
00	NZ	Z=0
01	Z	Z=1
10	NC	C=0
11	C	C=1

Restart Addresses:

t	T
000	X'00
001	X'08
010	X'10
011	X'18
100	X'20
101	X'28
110	X'30
111	X'38

12.4 8-Bit Loads

REGISTER TO REGISTER

LD r_d, r_s

Load register r_d with r_s :

$r_d \leftarrow r_s$ No flags affected

7 6 5 4 3 2 1 0

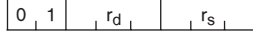

Timing: M cycles — 1

T states — 4

Addressing Mode: Register

LD A, I

Load Accumulator with the contents of the I register.

$A \leftarrow I$ S: Set if negative result

Z: Set if zero result

H: Reset

P/V: Set according to IFF₂ (zero if interrupt occurs during operation)

N: Reset

C: Not affected

7 6 5 4 3 2 1 0

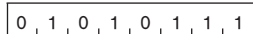
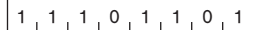

Timing: M cycles — 2

T states — 9 (4, 5)

Addressing Mode: Register

LD I, A

Load Interrupt vector register (I) with the contents of A.

$I \leftarrow A$ No flags affected

7 6 5 4 3 2 1 0

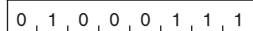
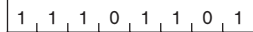

Timing: M cycles — 2

T states — 9 (4, 5)

Addressing Mode: Register

LD A, R

Load Accumulator with contents of R register.

$A \leftarrow R$ S: Set if negative result

Z: Set if zero result

H: Reset

P/V: Set according to IFF₂ (zero if interrupt occurs during operation)

N: Reset

C: Not affected

7 6 5 4 3 2 1 0

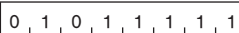
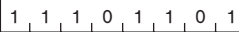

Timing: M cycles — 2

T states — 9 (4, 5)

Addressing Mode: Register

LD R, A

Load Refresh register (R) with contents of the Accumulator.

$R \leftarrow A$ No flags affected

7 6 5 4 3 2 1 0

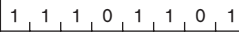

Timing: M cycles — 2

T states — 9 (4, 5)

Addressing Mode: Register

LD r, n

Load register r with immediate data n.

$r \leftarrow n$ No flags affected

7 6 5 4 3 2 1 0

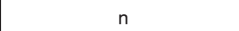
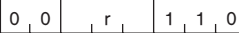

Timing: M cycles — 2

T states — 7 (4, 3)

Addressing Mode: Source — Immediate

Destination — Register

REGISTER TO MEMORY

LD m_1, r

Load memory from register r.

$m_1 \leftarrow r$ No flags affected

7 6 5 4 3 2 1 0

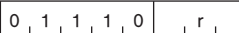

LD (HL), r

Timing: M cycles — 2

T states — 7 (4,3)

Addressing Mode: Source — Register

Destination — Register Indirect

7 6 5 4 3 2 1 0

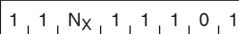

LD (IX + d), r (for $N_X = 0$)

LD (IY + d), r (for $N_X = 1$)

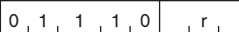

Timing: M cycles — 2

T states — 19 (4, 4, 3, 5, 3)

Addressing Mode: Source — Register

Destination — Indexed

12.4 8-Bit Loads (Continued)

LD m_2, A

Load memory from the Accumulator.

$m_2 \leftarrow A$ No flags affected

7 6 5 4 3 2 1 0
 0 0 0 0 0 0 1 0 LD (BC), A

0 0 0 1 0 0 1 0 LD (DE), A

Timing: M cycles—2
 T states—7 (4, 3)

Addressing Mode: Source—Register (Implied)
 Destination—Register Indirect

7 6 5 4 3 2 1 0
 0 0 1 1 0 0 1 0 LD (nn), A

n (low-order byte)

n (high-order byte)

Timing: M cycles—4
 T states—3 (4, 3, 3)

Addressing Mode: Source—Register (Implied)
 Destination—Direct

LD m_1, n

Load memory with immediate data.

$m_1 \leftarrow n$ No flags affected

7 6 5 4 3 2 1 0
 0 0 1 1 0 1 1 0 LD (HL), n

n

Timing: M cycles—3
 T states—10 (4, 3, 3)

Addressing Mode: Source—Immediate
 Destination—Register Indirect

7 6 5 4 3 2 1 0 LD (IX + d), n (for $N_X = 0$)
 1 1 N_X 1 1 1 0 1
 LD (IY + d), n (for $N_X = 1$)

0 0 1 1 0 1 1 0

d

n

Timing: M cycles—5
 T states—19 (4, 4, 3, 5, 3)

Addressing Mode: Source—Immediate
 Destination—Indexed

MEMORY TO REGISTER

LD r, m_1

Load register r from memory location m_1 .

$r \leftarrow m_1$ No flags affected

7 6 5 4 3 2 1 0
 0 1 r 1 1 0 LD R, (HL)

Timing: M cycles—2
 T states—7 (4, 3)

Addressing Mode: Source—Register Indirect
 Destination—Register

7 6 5 4 3 2 1 0 LD r, (IX + d) (for $N_X = 0$)
 1 1 N_X 1 1 1 0 1
 LD r, (IY + d) (for $N_X = 1$)

0 1 r 1 1 0

d

Timing: M cycles—5
 T states—19 (4, 4, 3, 5, 3)

Addressing Mode: Source—Indexed
 Destination—Register

LD A, m_2

Load the Accumulator from memory location m_2 .

$A \leftarrow m_2$ No flags affected

7 6 5 4 3 2 1 0 LD A, (BC)
 0 0 0 0 1 0 1 0

0 0 0 1 1 0 1 0 LD A, (DE)

Timing: M cycles—2
 T states—7 (4, 3)

Addressing Mode: Source—Register Indirect
 Destination—Register (Implied)

7 6 5 4 3 2 1 0 LD A, (nn)
 0 0 1 1 1 0 1 0

n (low-order byte)

n (high-order byte)

Timing: M cycles—4
 T states—13 (4, 3, 3, 3)

Addressing Mode: Source—Immediate Extended
 Destination—Register (Implied)

12.5 16-Bit Loads

REGISTER TO REGISTER

LD rr, nn

Load 16-bit register pair with immediate data.

rr, ← nn No flags affected

7 6 5 4 3 2 1 0 LD BC, nn
 0 0 rp 0 0 0 1 LD DE, nn
 LD HL, nn
 LD SP, nn

n (low-order byte)

n (high-order byte)

Timing: M cycles—3

T states—10 (4, 3, 3)

Addressing Mode: Source—Immediate Extended
 Destination—Register

7 6 5 4 3 2 1 0 LD IX, nn (for $N_X = 0$)
 1 1 N_X 1 1 1 0 1 LD IY, nn (for $N_X = 1$)

0 0 1 0 0 0 0 1

n (low-order byte)

n (high-order byte)

Timing: M cycles—4

T states—14 (4, 4, 3, 3)

Addressing Mode: Source—Immediate Extended
 Destination—Register

LD SP, ss

Load the SP from 16-bit register ss.

SP ← ss No flags affected

7 6 5 4 3 2 1 0 LD SP, HL
 1 1 1 1 1 0 0 1

Timing: M cycles—1

T states—6

Addressing Mode: Source—Register
 Destination—Register (Implied)

7 6 5 4 3 2 1 0 LD SP, IX (for $N_X = 0$)
 1 1 N_X 1 1 1 0 1 LD SP, IY (for $N_X = 1$)

1 1 1 1 1 0 0 1

Timing: M cycles—2

T states—10 (4, 6)

Addressing Mode: Source—Register
 Destination—Register (Implied)

REGISTER TO MEMORY

LD (nn), rr

Load memory location nn with contents of 16-bit register, rr.

(nn) ← rr_L No flags affected

(nn + 1) ← rr_H

7 6 5 4 3 2 1 0 LD (nn), HL
 0 0 1 0 0 0 1 0 (note an alternate
 opcode below)

n (low-order byte)

n (high-order byte)

Timing: M cycles—5

T states—16 (4, 3, 3, 3, 3)

Addressing Mode: Source—Register
 Destination—Direct

7 6 5 4 3 2 1 0 LD (nn), BC
 1 1 1 0 1 1 0 1 LD (nn), DE
 LD (nn), HL
 LD (nn), SP

0 1 rp 0 0 1 1

n (low-order byte)

n (high-order byte)

Timing: M cycles—6

T states—20 (4, 4, 3, 3, 3, 3)

Addressing Mode: Source—Register
 Destination—Direct

7 6 5 4 3 2 1 0 LD (nn), IX (for $N_X = 0$)
 1 1 N_X 1 1 1 0 1 LD (nn) IY (for $N_X = 1$)

0 0 1 0 0 0 1 0

n (low-order byte)

n (high-order byte)

Timing: M cycles—6

T states—20 (4, 4, 3, 3, 3, 3)

Addressing Mode: Source—Register
 Destination—Direct

12.5 16-Bit Loads (Continued)

PUSH qq

Push the contents of register pair qq onto the memory stack.

$(SP - 1) \leftarrow qq_H$ No flags affected

$(SP - 2) \leftarrow qq_L$

$SP \leftarrow SP - 2$

7	6	5	4	3	2	1	0	PUSH BC
1	1	rs	0	1	0	1		PUSH DE
								PUSH HL
								PUSH AF

Timing: M cycles—3
T states—11 (5, 3, 3)

Addressing Mode: Source—Register
Destination—Register Indirect (Stack)

7	6	5	4	3	2	1	0	PUSH IX (for $N_X=0$)
1	1	N_X	1	1	1	0	1	PUSH IY (for $N_X=1$)

1	1	1	0	0	1	0	1
---	---	---	---	---	---	---	---

Timing: M cycles—3
T states—15 (4, 5, 3, 3)

Addressing Mode: Source—Register
Destination—Register Indirect (Stack)

MEMORY TO REGISTER

LD rr, (nn)

Load 16-bit register from memory location nn.

$rr_L \leftarrow (nn)$ No flags affected

$rr_H \leftarrow (nn + 1)$

7	6	5	4	3	2	1	0	LD HL, (nn)
0	0	1	0	1	0	1	0	(note an alternate opcode below)

n (low-order byte)

n (high-order byte)

Timing: M cycles—5
T states—16 (4, 3, 3, 3, 3)

Addressing Mode: Source—Direct
Destination—Register

7	6	5	4	3	2	1	0	LD BC, (nn)
1	1	1	0	1	1	0	1	LD DE, (nn)
								LD HL, (nn)
0	1	rp	0	0	1	1		LD SP, (nn)

n (low-order byte)

n (high-order byte)

Timing: M cycles—6
T states—20 (4, 4, 3, 3, 3, 3)

Addressing Mode: Source—Direct
Destination—Register

7	6	5	4	3	2	1	0	LD IX, (nn) (for $N_X = 0$)
1	1	N_X	1	1	1	0	1	LD IY, (nn) (for $N_X = 1$)

0	0	1	0	1	0	1	0
---	---	---	---	---	---	---	---

n (low-order byte)

n (high-order byte)

Timing: M cycles—6
T states—20 (4, 4, 3, 3, 3, 3)

Addressing Mode: Source—Direct
Destination—Register

POP qq

Pop the contents of the memory stack to register qq.

$qq_L \leftarrow (SP)$ No flags affected

$qq_H \leftarrow (SP + 1)$

$SP \leftarrow SP + 2$

7	6	5	4	3	2	1	0	POP BC
1	1	rs	0	0	0	1		POP DE
								POP HL
								POP AF

Timing: M cycles—3
T states—10 (4, 3, 3)

Addressing Mode: Source—Register Indirect (Stack)
Destination—Register

7	6	5	4	3	2	1	0	POP IX (for $N_X=0$)
1	1	N_X	1	1	1	0	1	POP IY (for $N_X=1$)

1	1	1	0	0	0	0	1
---	---	---	---	---	---	---	---

Timing: M cycles—4
T states—14 (4, 4, 3, 3)

Addressing Mode: Source—Register Indirect (Stack)
Destination—Register

12.6 8-Bit Arithmetic

REGISTER ADDRESSING ARITHMETIC

Op	C Before DAA	Hex Value In Upper Digit (Bits 7-4)	H Before DAA	Hex Value In Lower Digit (Bits 3-0)	Number Added To Byte	C After DAA
	0	0-9	0	0-9	00	0
	0	0-8	0	A-F	06	0
	0	0-9	1	0-3	06	0
ADD	0	A-F	0	0-9	60	1
ADC	0	9-F	0	A-F	66	1
INC	0	A-F	1	0-3	66	1
	1	0-2	0	0-9	60	1
	1	0-2	0	A-F	66	1
	1	0-3	1	0-3	66	1
SUB	0	0-9	0	0-9	00	0
SBC	0	0-8	1	6-F	FA	0
DEC	1	7-F	0	0-9	A0	1
NEG	1	6-F	1	6-F	9A	1

ADD A, r

Add contents of register r to the Accumulator.

$A \leftarrow A + r$

S: Set if negative result

Z: Set if zero result

H: Set if carry from bit 3

P/V: Set according to overflow condition

N: Reset

C: Set if carry from bit 7

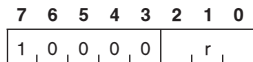

Timing: M cycles—1
T states—4

Addressing Mode: Source—Register
Destination—Implied

ADC A, r

Add contents of register r, plus the carry flag, to the Accumulator.

$A \leftarrow A + r + CY$

S: Set if negative result

Z: Set if zero result

H: Set if carry from bit 3

P/V: Set if result exceeds 2's complement range

N: Reset

C: Set if carry from bit 7



Timing: M cycles—1
T states—4

Addressing Mode: Source—Register
Destination—Implied

SUB r

Subtract the contents of register r from the Accumulator.

$A \leftarrow A - r$

S: Set if result is negative

Z: Set if result is zero

H: Set if borrow from bit 4

P/V: Set if result exceeds 8-bit 2's complement range

N: Set

C: Set according to borrow

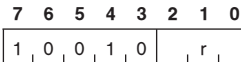

Timing: M cycles—1
T states—4

Addressing Mode: Source—Register
Destination—Implied

SBC A, r

Subtract contents of register r and the carry bit C from the Accumulator.

$A \leftarrow A - r - CY$

S: Set if result is negative

Z: Set if result is zero

H: Set if borrow from bit 4

P/V: Set if result exceeds 8-bit 2's complement range

N: Set

C: Set according to borrow

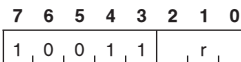

Timing: M cycles—1
T states—4

Addressing Mode: Source—Register
Destination—Implied

AND r

Logically AND the contents of the r register and the Accumulator.

$A \leftarrow A \wedge r$

S: Set if result is negative

Z: Set if result is zero

H: Set

P/V: Set if result parity is even

N: Reset

C: Reset

12.6 8-Bit Arithmetic (Continued)

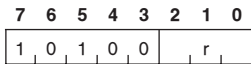

Timing: M cycles—1
T states—4

Addressing Mode: Source—Register
Destination—Implied

OR r

Logically OR the contents of the r register and the Accumulator.

$A \leftarrow A \vee r$

S: Set if result is negative
Z: Set if result is zero
H: Reset
P/V: Set if result parity is even
N: Reset
C: Reset

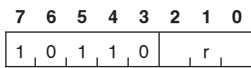

Timing: M cycles—1
T states—4

Addressing Mode: Source—Register
Destination—Implied

XOR r

Logically exclusively OR the contents of the r register with the Accumulator.

$A \leftarrow A \oplus r$

S: Set if result is negative
Z: Set if result is zero
H: Reset
P/V: Set if result parity is even
N: Reset
C: Reset

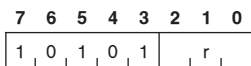

Timing: M cycles—1
T states—4

Addressing Mode: Source—Register
Destination—Implied

INC r

Increment register r.

$r \leftarrow r + 1$

S: Set if result is negative
Z: Set if result is zero
H: Set if carry from bit 3
P/V: Set only if r was X'7F before operation
N: Reset
C: N/A

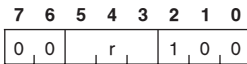

Timing: M cycles—1
T states—4

Addressing Mode: Source—Register
Destination—Register

CP r

Compare the contents of register r with the Accumulator and set the flags accordingly.

$A - r$

S: Set if result is negative
Z: Set if result is zero
H: Set if borrow from bit 4
P/V: Set if result exceeds 8-bit 2's complement range
N: Set
C: Set according to borrow

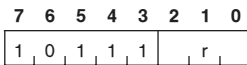

Timing: M cycles—1
T states—4

Addressing Mode: Source—Register
Destination—Implied

DEC r

Decrement the contents of register r.

$r \leftarrow r - 1$

S: Set if result is negative
Z: Set if result is zero
H: Set according to a borrow from bit 4
P/V: Set only if r was X'80 prior to operation
N: Set
C: N/A

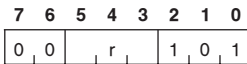

Timing: M cycles—1
T states—4

Addressing Mode: Source—Register
Destination—Register

CPL

Complement the Accumulator (1's complement).

$A \leftarrow \bar{A}$

S: N/A
Z: N/A
H: Set
P/V: N/A
N: Set
C: N/A

12.6 8-Bit Arithmetic (Continued)

7 6 5 4 3 2 1 0
 0 0 1 0 1 1 1 1

Timing: M cycles—1
 T states—4

Addressing Mode: Implied

NEG

Negate the Accumulator (2's complement).

$A \leftarrow 0 - A$ S: Set if result is negative
 Z: Set if result is zero
 H: Set according to borrow from bit 4
 P/V: Set only if Accumulator was X'80 prior to operation
 N: Set
 C: Set only if Accumulator was not X'00 prior to operation

7 6 5 4 3 2 1 0
 1 1 1 0 1 1 0 1

0 1 0 0 0 1 0 0

Timing: M cycles—2
 T states—8 (4, 4)

Addressing Mode: Implied

CCF

Complement the carry flag.

$CY \leftarrow \overline{CY}$ S: N/A
 Z: N/A
 H: Previous carry
 P/V: N/A
 N: Reset
 C: Complement of previous carry

7 6 5 4 3 2 1 0
 0 0 1 1 1 1 1 1

Timing: M cycles—1
 T states—4

Addressing Mode: Implied

SCF

Set the carry flag.

$CY \leftarrow 1$ S: N/A
 Z: N/A
 H: Reset
 P/V: N/A
 N: Reset
 C: Set

7 6 5 4 3 2 1 0
 0 0 1 1 0 1 1 1

Timing: M cycles—1
 T states—4

Addressing Mode: Implied

DAA

Adjust the Accumulator for BCD addition and subtraction operations. To be executed after BCD data has been operated upon the standard binary ADD, ADC, INC, SUB, SBC, DEC or NEG instructions (see "Register Addressing Arithmetic" table).

S: Set according to bit 7 of result
 Z: Set if result is zero
 H: Set according to instructions
 P/V: Set according to parity of result
 N: N/A
 C: Set according to instructions

7 6 5 4 3 2 1 0
 0 0 1 0 0 1 1 1

Timing: M cycles—1
 T states—4

Addressing Mode: Implied

IMMEDIATELY ADDRESSED ARITHMETIC

ADD A, n

Add the immediate data n to the Accumulator.

$A \leftarrow A + n$ S: Set if result is negative
 Z: Set if result is zero
 H: Set if carry from bit 3
 P/V: Set if result exceeds 8-bit 2's complement range
 N: Reset
 C: Set if carry from bit 7

7 6 5 4 3 2 1 0
 1 1 0 0 0 1 1 0

n

Timing: M cycles—2
 T states—7 (4, 3)

Addressing Mode: Source—Immediate
 Destination—Implied

ADC A, n

Add, with carry, the immediate data n and the Accumulator.

$A \leftarrow A + n + CY$ S: Set if result is negative
 Z: Set if result is zero
 H: Set if carry from bit 3
 P/V: Set if result exceeds 8-bit 2's complement range
 N: Reset
 C: Set according to carry from bit 7

12.6 8-Bit Arithmetic (Continued)

7 6 5 4 3 2 1 0
 1 1 0 0 1 1 1 0

n

Timing: M cycles—2
 T states—7 (4, 3)
 Addressing Mode: Source—Immediate
 Destination—Implied

SUB n

Subtract the immediate data n from the Accumulator.

$A \leftarrow A - n$ S: Set if result is negative
 Z: Set if result is zero
 H: Set if borrow from bit 4
 P/V: Set if result exceeds 8-bit 2's complement range
 N: Set
 C: Set according to borrow condition

7 6 5 4 3 2 1 0
 1 1 0 1 0 1 1 0

n

Timing: M cycles—2
 T states—7 (4, 3)
 Addressing Mode: Source—Immediate
 Destination—Implied

SBC A, n

Subtract, with carry, the immediate data n from the Accumulator.

$A \leftarrow A - n - CY$ S: Set if result is negative
 Z: Set if result is zero
 H: Set if borrow from bit 4
 P/V: Set if result exceeds 8-bit 2's complement range
 N: Set
 C: Set according to borrow condition

7 6 5 4 3 2 1 0
 1 1 0 1 1 1 1 0

n

Timing: M cycles—2
 T states—7 (4, 3)
 Addressing Mode: Source—Immediate
 Destination—Implied

AND n

The immediate data n is logically AND'ed to the Accumulator.

$A \leftarrow A \wedge n$ S: Set if result is negative
 Z: Set if result is zero
 H: Set
 P/V: Set if result parity is even
 N: Reset
 C: Reset

7 6 5 4 3 2 1 0
 1 1 1 0 0 1 1 0

n

Timing: M cycles—2
 T states—7 (4, 3)
 Addressing Mode: Source—Immediate
 Destination—Implied

OR n

The immediate data n is logically OR'ed to the contents of the Accumulator.

$A \leftarrow A \vee n$ S: Set if result is negative
 Z: Set if result is zero
 H: Reset
 P/V: Set if result parity is even
 N: Reset
 C: Reset

7 6 5 4 3 2 1 0
 1 1 1 1 0 1 1 0

n

Timing: M cycles—2
 T states—7 (4, 3)
 Addressing Mode: Source—Immediate
 Destination—Implied

XOR n

The immediate data n is exclusively OR'ed with the Accumulator.

$A \leftarrow A \oplus n$ S: Set if result is negative
 Z: Set if result is zero
 H: Reset
 P/V: Set if result parity is even
 N: Reset
 C: Reset

12.6 8-Bit Arithmetic (Continued)

7 6 5 4 3 2 1 0
 1 1 1 0 1 1 1 0

n

Timing: M cycles—2
 T states—7 (4, 3)
 Addressing Mode: Source—Immediate
 Destination—Implied

CP n

Compare the immediate data n with the contents of the Accumulator via subtraction and return the appropriate flags. The contents of the Accumulator are not affected.

$A - n$ S: Set if result is negative
 Z: Set if result is zero
 H: Set if borrow from bit 4
 P/V: Set if result exceeds 8-bit 2's complement range
 N: Set
 C: Set according to borrow condition

7 6 5 4 3 2 1 0
 1 1 1 1 1 1 1 0

n

Timing: M cycles—2
 T states—7 (4, 3)
 Addressing Mode: Immediate

MEMORY ADDRESSED ARITHMETIC

ADD A, m₁

Add the contents of the memory location m₁ to the Accumulator.

$A \leftarrow A + m_1$ S: Set if result is negative
 Z: Set if result is zero
 H: Set if carry from bit 3
 P/V: Set if result exceeds 8-bit 2's complement range
 N: Reset
 C: Set according to carry from bit 7

7 6 5 4 3 2 1 0
 1 0 0 0 0 1 1 0

Timing: M cycles—2
 T states—7 (4, 3)
 Addressing Mode: Source—Register Indirect
 Destination—Implied

7 6 5 4 3 2 1 0
 1 1 N_X 1 1 1 0 1

1 0 0 0 0 1 1 0

d

Timing: M cycles—5
 T states—19 (4, 4, 3, 5, 3)
 Addressing Mode: Source—Indexed
 Destination—Implied

ADC A, m₁

Add the contents of the memory location m₁ plus the carry to the Accumulator.

$A \leftarrow A + m_1 + CY$ S: Set if result is negative
 Z: Set if result is zero
 H: Set if carry from bit 3
 P/V: Set if result exceeds 8-bit 2's complement range
 N: Reset
 C: Set according to carry from bit 7

7 6 5 4 3 2 1 0
 1 0 0 0 1 1 1 0

ADC A, (HL)
 Timing: M cycles—2
 T states—7 (4, 3)
 Addressing Mode: Source—Register Indirect
 Destination—Implied

7 6 5 4 3 2 1 0
 1 1 N_X 1 1 1 0 1

1 0 0 0 1 1 1 0

d

Timing: M cycles—5
 T states—19 (4, 4, 3, 5, 3)
 Addressing Mode: Source—Indexed
 Destination—Implied

SUB m₁

Subtract the contents of memory location m₁ from the Accumulator.

$A \leftarrow A - m_1$ S: Set if result is negative
 Z: Set if result is zero
 H: Set if borrow from bit 4
 P/V: Set if result exceeds 8-bit 2's complement range
 N: Set
 C: Set according to borrow condition

12.6 8-Bit Arithmetic (Continued)

7 6 5 4 3 2 1 0

1 0 0 1 0 1 1 0

SUB (HL)

Timing: M cycles—2

T states—7 (4, 3)

Addressing Mode: Source—Register Indirect

Destination—Implied

7 6 5 4 3 2 1 0

1 1 N_X 1 1 1 0 1

SUB (IX + d) (for $N_X=0$)

SUB (IY + d) (for $N_X=1$)

1 0 0 1 0 1 1 0

d

Timing: M cycles—5

T states—19 (4, 4, 3, 5, 3)

Addressing Mode: Source—Indexed

Destination—Implied

SBC A, m_1

Subtract, with carry, the contents of memory location m_1 from the Accumulator.

$A \leftarrow A - m_1 - CY$ S: Set if result is negative

Z: Set if result is zero

H: Set if carry from bit 3

P/V: Set if result exceeds 8-bit 2's complement range

N: Set

C: Set according to borrow condition

7 6 5 4 3 2 1 0

1 0 0 1 1 1 1 0

SBC A, (HL)

Timing: M cycles—2

T states—7 (4, 3)

Addressing Mode: Source—Register Indirect

Destination—Implied

7 6 5 4 3 2 1 0

1 1 N_X 1 1 1 0 1

SBC A, (IX + d) (for $N_X=0$)

SBC A, (IY + d) (for $N_X=1$)

1 0 0 1 1 1 1 0

d

Timing: M cycles—5

T states—19 (4, 4, 3, 5, 3)

Addressing Mode: Source—Indexed

Destination—Implied

AND m_1

The data in memory location m_1 is logically AND'ed to the Accumulator.

$A \leftarrow A \wedge m_1$

S: Set if result is negative

Z: Set if result is zero

H: Set

P/V: Set if result parity is even

N: Reset

C: Reset

7 6 5 4 3 2 1 0

1 0 1 0 0 1 1 0

AND (HL)

Timing: M cycles—2

T states—7 (4, 3)

Addressing Mode: Source—Register Indirect

Destination—Implied

7 6 5 4 3 2 1 0

1 1 N_X 1 1 1 0 1

AND (IX + d) (for $N_X=0$)

AND (IY + d) (for $N_X=1$)

1 0 1 0 0 1 1 0

d

Timing: M cycles—5

T states—19 (4, 4, 3, 5, 3)

Addressing Mode: Source—Indexed

Destination—Implied

OR m_1

The data in memory location m_1 is logically OR'ed with the Accumulator.

$A \leftarrow A \vee m_1$

S: Set if result is negative

Z: Set if result is zero

H: Reset

P/V: Set if result parity is even

N: Reset

C: Reset

7 6 5 4 3 2 1 0

1 0 1 1 0 1 1 0

OR (HL)

Timing: M cycles—2

T states—7 (4, 3)

Addressing Mode: Source—Register Indexed

Destination—Implied

7 6 5 4 3 2 1 0

1 1 N_X 1 1 1 0 1

OR (IX + d) (for $N_X=0$)

OR (IY + d) (for $N_X=1$)

1 0 1 1 0 1 1 0

d

Timing: M cycles—5

T states—19 (4, 4, 3, 5, 3)

Addressing Mode: Source—Indexed

Destination—Implied

12.6 8-Bit Arithmetic (Continued)

XOR m_1

The data in memory location m_1 is exclusively OR'ed with the data in the Accumulator.

$A \leftarrow A \oplus m_1$

S: Set if result is negative
 Z: Set if result is zero
 H: Reset
 P/V: Set if result parity is even
 N: Reset
 C: Reset

7	6	5	4	3	2	1	0
1	0	1	0	1	1	1	0

 XOR (HL)

Timing: M cycles—2
 T states—7 (4, 3)

Addressing Mode: Source—Register Indexed
 Destination—Implied

7	6	5	4	3	2	1	0
1	1	N_X	1	1	1	0	1

 XOR (IX + d) (for $N_X=0$)
 XOR (IY + d) (for $N_X=1$)

7	6	5	4	3	2	1	0
1	0	1	0	1	1	1	0

d							
---	--	--	--	--	--	--	--

Timing: M cycles—5
 T states—19 (4, 4, 3, 5, 3)

Addressing Mode: Source—Indexed
 Destination—Implied

CP m_1

Compare the data in memory location m_1 with the data in the Accumulator via subtraction.

$A - m_1$

S: Set if result is negative
 Z: Set if result is zero
 H: Set if borrow from bit 4
 P/V: Set if result exceeds 8-bit 2's complement range
 N: Set
 C: Set according to borrow condition

7	6	5	4	3	2	1	0
1	0	1	1	1	1	1	0

 CP (HL)

Timing: M cycles—2
 T states—7 (4, 3)

Addressing Mode: Source—Register Indirect
 Destination—Implied

7	6	5	4	3	2	1	0
1	1	N_X	1	1	1	0	1

 CP (IX + d) (for $N_X=0$)
 CP (IY + d) (for $N_X=1$)

7	6	5	4	3	2	1	0
1	0	1	1	1	1	1	0

d							
---	--	--	--	--	--	--	--

Timing: M cycles—5
 T states—19 (4, 4, 3, 5, 3)

Addressing Mode: Source—Indexed
 Destination—Implied

INC m_1

Increment data in memory location m_1 .

$m_1 \leftarrow m_1 + 1$

S: Set if result is negative
 Z: Set if result is zero
 H: Set according to carry from bit 3
 P/V: Set if data was X'7F before operation
 N: Reset
 C: N/A

7	6	5	4	3	2	1	0
0	0	1	1	0	1	0	0

 INC (HL)

Timing: M cycles—3
 T states—11 (4, 4, 3)

Addressing Mode: Source—Register Indexed
 Destination—Register Indexed

7	6	5	4	3	2	1	0
1	1	N_X	1	1	1	0	1

 INC (IX + d) (for $N_X=0$)
 INC (IY + d) (for $N_X=1$)

7	6	5	4	3	2	1	0
0	0	1	1	0	1	0	0

d							
---	--	--	--	--	--	--	--

Timing: M cycles—6
 T states—23 (4, 4, 3, 5, 4, 3)

Addressing Mode: Source—Indexed
 Destination—Indexed

DEC m_1

Decrement data in memory location m_1 .

$m_1 \leftarrow m_1 - 1$

S: Set if result is negative
 Z: Set if result is zero
 H: Set according to borrow from bit 4
 P/V: Set only if m_1 was X'80 before operation
 N: Set
 C: N/A

12.6 8-Bit Arithmetic (Continued)

7 6 5 4 3 2 1 0
 0 0 1 1 0 1 0 1

DEC (HL)

Timing: M cycles — 3
 T states — 11 (4, 4, 3)

Addressing Mode: Source — Register Indexed
 Destination — Register Indexed

7 6 5 4 3 2 1 0
 1 1 N_X 1 1 1 0 1

DEC (IX + d) (for N_X = 0)
 DEC (IY + d) (for N_X = 1)

0 0 1 1 0 1 0 1

d

Timing: M cycles — 6
 T states — 23 (4, 4, 3, 5, 4, 3)

Addressing Mode: Source — Indexed
 Destination — Indexed

12.7 16-Bit Arithmetic

ADD ss, pp

Add the contents of the 16-bit register rp or pp to the contents of the 16-bit register ss.

ss ← ss + rp S: N/A
 or Z: N/A
 ss ← ss + pp H: Set if carry from bit 11
 P/V: N/A
 N: Reset
 C: Set if carry from bit 15

7 6 5 4 3 2 1 0
 0 0 rp 1 0 0 1

ADD HL, rp

Timing: M cycles — 3
 T states — 11 (4, 4, 3)

Addressing Mode: Source — Register
 Destination — Register

7 6 5 4 3 2 1 0
 1 1 N_X 1 1 1 0 1

ADD IX, pp (for N_X = 0)
 ADD IY, pp (for N_X = 1)

0 0 pp 1 0 0 1

Timing: M cycles — 4
 T states — 15 (4, 4, 4, 3)

Addressing Mode: Source — Register
 Destination — Register

ADC HL, pp

The contents of the 16-bit register pp are added, with the carry bit, to the HL register.

HL ← HL + pp + CY
 S: Set if result is negative
 Z: Set if result is zero
 H: Set according to carry out of bit 11

P/V: Set if result exceeds 16-bit 2's complement range

N: Reset

C: Set if carry out of bit 15

7 6 5 4 3 2 1 0
 1 1 1 0 1 1 0 1

0 1 pp 1 0 1 0

Timing: M cycles — 4
 T states — 15 (4, 4, 4, 3)

Addressing Mode: Source — Register
 Destination — Register

SBC HL, pp

Subtract, with carry, the contents of the 16-bit pp register from the 16-bit HL register.

HL ← HL - pp - CY
 S: Set if result is negative
 Z: Set if result is zero
 H: Set according to borrow from bit 12
 P/V: Set if result exceeds 16-bit 2's complement range
 N: Set
 C: Set according to borrow condition

7 6 5 4 3 2 1 0
 1 1 1 0 1 1 0 1

0 1 pp 0 0 1 0

Timing: M cycles — 4
 T states — 15 (4, 4, 4, 3)

Addressing Mode: Source — Register
 Destination — Register

INC rr

Increment the contents of the 16-bit register rr.

rr ← rr + 1 No flags affected

7 6 5 4 3 2 1 0
 0 0 rp 0 0 1 1

INC BC
 INC DE
 INC HL
 INC SP

Timing: M cycles — 1
 T states — 6

Addressing Mode: Register

7 6 5 4 3 2 1 0
 1 1 N_X 1 1 1 0 1

INC IX (for N_X = 0)
 INC IY (for N_X = 1)

0 0 1 0 0 0 1 1

Timing: M cycles — 2
 T states — 10 (4, 6)

Addressing Mode: Register

12.7 16-Bit Arithmetic (Continued)

DEC rr

Decrement the contents of the 16-bit register rr.

$rr \leftarrow rr - 1$ No flags affected

7 6 5 4 3 2 1 0 DEC BC

0 0 rp 1 0 1 1 DEC DE
DEC HL
DEC SP

Timing: M cycles — 1
T states — 6

Addressing Mode: Register

7 6 5 4 3 2 1 0 DEC IX (for $N_X=0$)

1 1 N_X 1 1 1 0 1 DEC IY (for $N_X=1$)

0 0 1 0 1 0 1 1

Timing: M cycles — 2
T states — 10 (4, 6)

Addressing Mode: Register

12.8 Bit Set, Reset, and Test

REGISTER

SET b, r

Bit b in register r is set.

$R_b \leftarrow 1$ No flags affected

7 6 5 4 3 2 1 0
1 1 0 0 1 0 1 1

1 1 b r

Timing: M cycles — 2
T states — 8 (4, 4)

Addressing Mode: Bit/Register

RES b, r

Bit b in register r is reset.

$r_b \leftarrow 0$ No flags affected

7 6 5 4 3 2 1 0
1 1 0 0 1 0 1 1

1 0 b r

Timing: M cycles — 2
T states — 8 (4, 4)

Addressing Mode: Bit/Register

BIT b, r

Bit b in register r is tested with the result put in the Z flag.

$Z \leftarrow \bar{r}_b$

S: Undefined
Z: Inverse of tested bit
H: Set
P/V: Undefined
N: Reset
C: N/A

7 6 5 4 3 2 1 0
1 1 0 0 1 0 1 1

0 1 b r

Timing: M cycles — 2
T states — 8 (4, 4)

Addressing Mode: Bit/Register

MEMORY

SET b, m₁

Bit b in memory location m₁ is set.

$m_{1b} \leftarrow 1$ No flags affected

7 6 5 4 3 2 1 0
1 1 0 0 1 0 1 1 SET b, (HL)

1 1 b 1 1 0

Timing: M cycles — 4
T states — 15 (4, 4, 4, 3)

Addressing Mode: Bit/Register Indirect

7 6 5 4 3 2 1 0 SET b, (IX + d) (for $N_X=0$)

1 1 N_X 1 1 1 0 1 SET b, (IY + d) (for $N_X=1$)

1 1 0 0 1 0 1 1

d

1 1 b 1 1 0

Timing: M cycles — 6
T states — 23 (4, 4, 3, 5, 4, 3)

Addressing Mode: Bit/Indexed

RES b, m₁

Bit b in memory location m₁ is reset.

$m_{1b} \leftarrow 0$ No flags affected

7 6 5 4 3 2 1 0
1 1 0 0 1 0 1 1 RES b, (HL)

1 0 b 1 1 0

Timing: M cycles — 4
T states — 15 (4, 4, 4, 3)

Addressing Mode: Bit/Register Indirect

7 6 5 4 3 2 1 0 RES b, (IX + d) (for $N_X=0$)

1 1 N_X 1 1 1 0 1 RES b, (IY + d) (for $N_X=1$)

1 1 0 0 1 0 1 1

d

1 0 b 1 1 0

Timing: M cycles — 6
T states — 23 (4, 4, 3, 5, 4, 3)

Addressing Mode: Bit/Indexed

12.8 Bit Set, Reset, and Test (Continued)

BIT B, m₁

Bit b in memory location m₁ is tested via the Z flag.

$Z \leftarrow \overline{m_{1b}}$

S: Undefined

Z: Inverse of tested bit

H: Set

P/V: Undefined

N: Reset

C: N/A

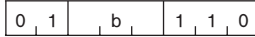
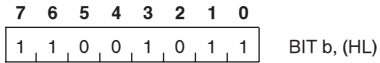

Timing: M cycles — 3
T states — 12 (4, 4, 4)

Addressing Mode: Bit/Register Indirect

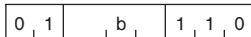
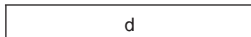
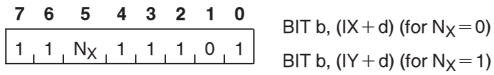

Timing: M cycles — 5
T states — 20 (4, 4, 3, 5, 4)

Addressing Mode: Bit/Index

12.9 Rotate and Shift

REGISTER

RLC r

Rotate register r left circular.

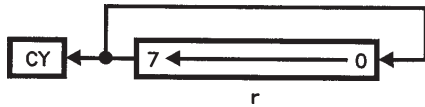

TL/C/5171-57

S: Set if result is negative

Z: Set if result is zero

H: Reset

P/V: Set if result parity is even

N: Reset

C: Set according to bit 7 of r

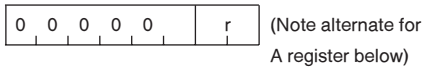
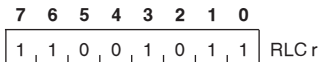

Timing: M cycles — 2
T states — 8 (4, 4)

Addressing Mode: Register

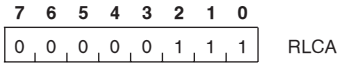

Timing: M cycles — 1
T states — 4

Addressing Mode: Implied
(Note RLCA does not affect S, Z, or P/V flags.)

RL r

Rotate register r left through carry.

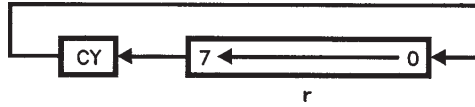

TL/C/5171-58

S: Set if result is negative

Z: Set if result is zero

H: Reset

P/V: Set if result parity is even

N: Reset

C: Set according to bit 7 of r

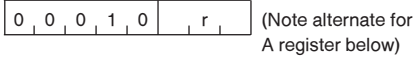
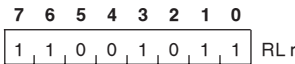

Timing: M cycles — 2
T states — 8 (4, 4)

Addressing Mode: Register

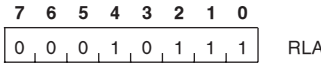

Timing: M cycles — 1
T states — 4

Addressing Mode: Implied
(Note RLA does not affect S, Z, or P/V flags.)

RRC r

Rotate register r right circular.

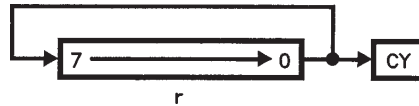

TL/C/5171-59

S: Set if result is negative

Z: Set if result is zero

H: Reset

P/V: Set if result parity is even

N: Reset

C: Set according to bit 0 of r

12.9 Rotate and Shift (Continued)

7 6 5 4 3 2 1 0

1 1 0 0 1 0 1 1

RRC r

0 0 0 0 1 r

(Note alternate for
A register below)

Timing: M cycles — 2
T states — 8 (4, 4)

Addressing Mode: Register

7 6 5 4 3 2 1 0

0 0 0 0 1 1 1 1

RRCA

Timing: M cycles — 1
T states — 4

Addressing Mode: Implied

(Note RRCA does not affect S, Z, or P/V flags.)

RR r

Rotate register r right through carry.

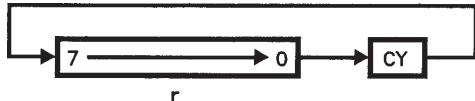

TL/C/5171-60

S: Set if result is negative
Z: Set if result is zero
H: Reset
P/V: Set if result parity is even
N: Reset
C: Set according to bit 0 of r

7 6 5 4 3 2 1 0

1 1 0 0 1 0 0 1

RR r

0 0 0 1 1 r

(Note alternate for
A register below)

Timing: M cycles — 2
T states — 8 (4, 4)

Addressing Mode: Register

7 6 5 4 3 2 1 0

0 0 0 1 1 1 1 1

RRA

Timing: M cycles — 1
T states — 4

Addressing Mode: Implied

(Note RRA does not affect S, Z, or P/V flags.)

SLA r

Shift register r left arithmetic.



TL/C/5171-61

S: Set if result is negative
Z: Set if result is zero
H: Reset

P/V: Set if result parity is even

N: Reset

C: Set according to bit 7 of r

7 6 5 4 3 2 1 0

1 1 0 0 1 0 1 1

0 0 1 0 0 r

Timing: M cycles — 2
T states — 8 (4, 4)

Addressing Mode: Register

SRA r

Shift register r right arithmetic.



TL/C/5171-62

S: Set if result is negative
Z: Set if result is zero
H: Reset
P/V: Set if result parity is even
N: Reset
C: Set according to bit 0 of r

7 6 5 4 3 2 1 0

1 1 0 0 1 0 1 1

0 0 1 0 1 r

Timing: M cycles — 2
T states — 8 (4, 4)

Addressing Mode: Register

SRL r

Shift register r right logical.

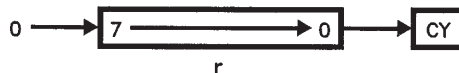

TL/C/5171-63

S: Reset
Z: Set if result is zero
H: Reset
P/V: Set if result parity is even
N: Reset
C: Set according to bit 0 of r

7 6 5 4 3 2 1 0

1 1 0 0 1 0 1 1

0 0 1 1 1 r

Timing: M cycles — 2
T states — 8 (4, 4)

Addressing Mode: Register

12.9 Rotate and Shift (Continued)

MEMORY

RLC m_1

Rotate data in memory location m_1 left circular.

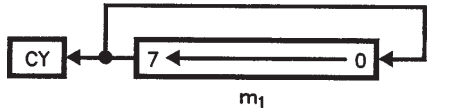

- TL/C/5171-64
- S: Set if result is negative
 - Z: Set if result is zero
 - H: Reset
 - P/V: Set if result parity is even
 - N: Reset
 - C: Set according to bit 7 of m_1

7 6 5 4 3 2 1 0
1 1 0 0 1 0 1 1 RLC (HL)

0 0 0 0 0 1 1 0

Timing: M cycles — 4
T states — 15 (4, 4, 4, 3)

Addressing Mode: Register indirect

7 6 5 4 3 2 1 0 RLC (IX + d) (for $N_X=0$)
1 1 N_X 1 1 1 0 1 RLC (IX + d) (for $N_X=1$)

1 1 0 0 1 0 1 1

d

0 0 0 0 0 1 1 0

Timing: M cycles — 6
T states — 23 (4, 4, 3, 5, 4, 3)

Addressing Mode: Indexed

RL m_1

Rotate the data in memory location m_1 left though carry.

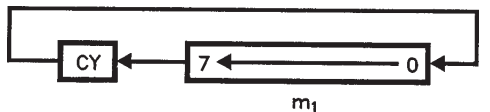

- TL/C/5171-65
- S: Set if result is negative
 - Z: Set if result is zero
 - H: Reset
 - P/V: Set if result parity is even
 - N: Reset
 - C: Set according to bit 7 of m_1

7 6 5 4 3 2 1 0
1 1 0 0 1 0 1 1 RL (HL)

0 0 0 1 0 1 1 0

Timing: M cycles — 4
T states — 15 (4, 4, 4, 3)

Addressing Mode: Register Indirect

7 6 5 4 3 2 1 0 RL (IX + d) (for $N_X=0$)
1 1 N_X 1 1 1 0 1 RL (IX + d) (for $N_X=1$)

1 1 0 0 1 0 1 1

d

0 0 0 1 0 1 1 0

Timing: M cycles — 6
T states — 23 (4, 4, 3, 5, 4, 3)

Addressing Mode: Indexed

RRC m_1

Rotate the data in memory location m_1 right circular.



- TL/C/5171-66
- S: Set if result is negative
 - Z: Set if result is zero
 - H: Reset
 - P/V: Set if result parity is even
 - N: Reset
 - C: Set according to bit 0 of m_1

7 6 5 4 3 2 1 0
1 1 0 0 1 0 1 1 RRC (HL)

0 0 0 0 1 1 1 0

Timing: M cycles — 4
T states — 15 (4, 4, 4, 3)

Addressing Mode: Register Indirect

7 6 5 4 3 2 1 0 RRC (IX + d) (for $N_X=0$)
1 1 N_X 1 1 1 0 1 RRC (IX + d) (for $N_X=1$)

1 1 0 0 1 0 1 1

d

0 0 0 0 1 1 1 0

Timing: M cycles — 6
T states — 23 (4, 4, 3, 5, 4, 3)

Addressing Mode: Indexed

12.9 Rotate and Shift (Continued)

RR m_1

Rotate the data in memory location m_1 right through the carry.

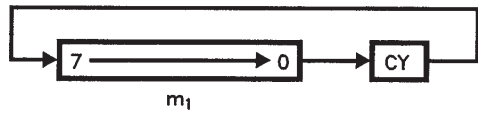

TL/C/5171-67

- S: Set if result is negative
- Z: Set if result is zero
- H: Reset
- P/V: Set if result parity is even
- N: Reset
- C: Set according to bit 0 of m_1

7 6 5 4 3 2 1 0

1 1 0 0 1 0 1 1

RR (HL)

0 0 0 1 1 1 1 0

Timing: M cycles — 4
T states — 15 (4, 4, 4, 3)

Addressing Mode: Register Indirect

7 6 5 4 3 2 1 0

1 1 N_X 1 1 1 0 1

RR (IX + d) (for $N_X = 0$)

1 1 0 0 1 0 1 1

RR (IY + d) (for $N_X = 1$)

d

0 0 0 1 1 1 1 0

Timing: M cycles — 6
T states — 23 (4, 4, 3, 5, 4, 3)

Addressing Mode: Indexed

SLA m_1

Shift the data in memory location m_1 left arithmetic.

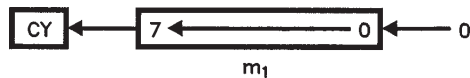

TL/C/5171-68

- S: Set if result is negative
- Z: Set if result is zero
- H: Reset
- P/V: Set if result parity is even
- N: Reset
- C: Set according to bit 7 of m_1

7 6 5 4 3 2 1 0

1 1 0 0 1 0 1 1

SLA (HL)

0 0 1 0 0 1 1 0

Timing: M cycles — 4
T states — 15 (4, 4, 4, 3)

Addressing Mode: Register Indirect

7 6 5 4 3 2 1 0

1 1 N_X 1 1 1 0 1

SLA (IX + d) (for $N_X = 0$)

1 1 0 0 1 0 1 1

SLA (IY + d) (for $N_X = 1$)

d

0 0 1 0 0 1 1 0

Timing: M cycles — 6
T states — 23 (4, 4, 3, 5, 4, 3)

Addressing Mode: Indexed

SRA m_1

Shift the data in memory location m_1 right arithmetic.

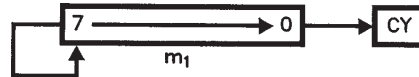

TL/C/5171-69

- S: Set if result is negative
- Z: Set if result is zero
- H: Reset
- P/V: Set if result parity is even
- N: Reset
- C: Set according to bit 0 of m_1

7 6 5 4 3 2 1 0

1 1 0 0 1 0 1 1

SRA (HL)

0 0 1 0 1 1 1 0

Timing: M cycles — 4
T states — 15 (4, 4, 4, 3)

Addressing Mode: Register Indirect

7 6 5 4 3 2 1 0

1 1 N_X 1 1 1 0 1

SRA (IX + d) (for $N_X = 0$)

1 1 0 0 1 0 1 1

SRA (IY + d) (for $N_X = 1$)

d

0 0 1 0 1 1 1 0

Timing: M cycles — 6
T states — 23 (4, 4, 3, 5, 4, 3)

Addressing Mode: Indexed

SRL m_1

Shift right logical the data in memory location m_1 .

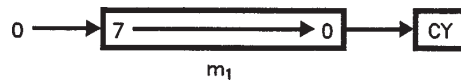

TL/C/5171-70

- S: Reset
- Z: Set if result is zero
- H: Reset
- P/V: Set if result parity is even
- N: Reset
- C: Set according to bit 0 of m_1

12.9 Rotate and Shift (Continued)

7 6 5 4 3 2 1 0

1 1 0 0 1 0 1 1

SRL (HL)

0 0 1 1 1 1 1 0

Timing:

M cycles — 4

T states — 15 (4, 4, 4, 3)

Addressing Mode:

Register Indirect

7 6 5 4 3 2 1 0

1 1 N_X 1 1 1 0 1

SRL (IX + d) (for $N_X = 0$)

1 1 0 0 1 0 1 1

SRL (IY + d) (for $N_X = 1$)

d

0 0 1 1 1 1 1 0

Timing:

M cycles — 6

T states — 23 (4, 4, 3, 5, 4, 3)

Addressing Mode:

Indexed

REGISTER/MEMORY

RLD

Rotate digit left and right between the Accumulator and memory (HL).

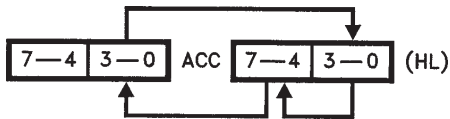

TL/C/5171-71

S: Set if result is negative

Z: Set if result is zero

H: Reset

P/V: Set if result parity is even

N: Reset

C: N/A

7 6 5 4 3 2 1 0

1 1 1 0 1 1 0 1

0 1 1 0 1 1 1 1

Timing:

M cycles — 5

T states — 18 (4, 4, 3, 4, 3)

Addressing Mode:

Implied/Register Indirect

RRD

Rotate digit right and left between the Accumulator and memory (HL).

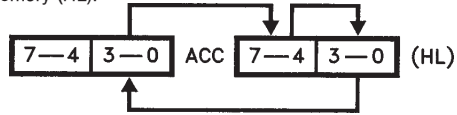

TL/C/5171-72

S: Set if result is negative

Z: Set if result is zero

H: Reset

P/V: Set if result parity is even

N: Reset

C: N/A

7 6 5 4 3 2 1 0

1 1 1 0 1 1 0 1

0 1 1 0 0 1 1 1

Timing:

M cycles — 5

T states — 18 (4, 4, 3, 4, 3)

Addressing Mode:

Implied/Register Indirect

12.10 Exchanges

REGISTER/REGISTER

EX DE, HL

Exchange the contents of the 16-bit register pairs DE and HL.

DE \leftrightarrow HL

No flags affected

7 6 5 4 3 2 1 0

1 1 1 0 1 0 1 1

Timing:

M cycles — 1

T states — 4

Addressing Mode:

Register

EX AF, A'F'

The contents of the Accumulator and flag register are exchanged with their corresponding alternate registers, that is A and F are exchanged with A' and F'.

A \leftrightarrow A'

No flags affected

F \leftrightarrow F'

7 6 5 4 3 2 1 0

0 0 0 0 1 0 0 0

Timing:

M cycles — 1

T states — 4

Addressing Mode:

Register

12.10 Exchanges (Continued)

EXX

Exchange the contents of the BC, DE, and HL registers with their corresponding alternate register.

BC \leftrightarrow B'C' No flags affected
 DE \leftrightarrow D'E'
 HL \leftrightarrow H'L'

7	6	5	4	3	2	1	0
1	1	0	1	1	0	0	1

Timing: M cycles — 1
 T states — 4

Addressing Mode: Implied

REGISTER/MEMORY

EX (SP), ss

Exchange the two bytes at the top of the external memory stack with the 16-bit register ss.

(SP) \leftrightarrow SS_L No flags affected
 (SP + 1) \leftrightarrow SS_H

7	6	5	4	3	2	1	0
1	1	1	0	0	0	1	1

EX (SP), HL

Timing: M cycles — 5
 T states — 19 (4, 3, 4, 3, 5)

Addressing Mode: Register/Register Indirect

7	6	5	4	3	2	1	0
1	1	N _X	1	1	1	0	1

EX (SP), IX (for N_X = 0)

EX (SP), IY (for N_X = 1)

7	6	5	4	3	2	1	0
1	1	1	0	0	0	1	1

Timing: M cycles — 6
 T states — 23 (4, 4, 3, 4, 3, 5)

Addressing Mode: Register/Register Indirect

12.11 Memory Block Moves and Searches

SINGLE OPERATIONS

LDI

Move data from memory location (HL) to memory location (DE), increment memory pointers, and decrement byte counter BC.

(DE) \leftarrow (HL) S: N/A
 DE \leftarrow DE + 1 Z: N/A
 HL \leftarrow HL + 1 H: Reset
 BC \leftarrow BC - 1 P/V: Set if BC - 1 \neq 0, otherwise reset
 N: Reset
 C: N/A

7	6	5	4	3	2	1	0
1	1	1	0	1	1	0	1

7	6	5	4	3	2	1	0
1	0	1	0	0	0	0	0

Timing: M cycles — 4
 T states — 16 (4, 4, 3, 5)

Addressing Mode: Register Indirect

LDD

Move data from memory location (HL) to memory location (DE), and decrement memory pointer and byte counter BC.

(DE) \leftarrow (HL) S: N/A
 DE \leftarrow DE - 1 Z: N/A
 HL \leftarrow HL - 1 H: Reset
 BC \leftarrow BC - 1 P/V: Set if BC - 1 \neq 0, otherwise reset
 N: Reset
 C: N/A

7	6	5	4	3	2	1	0
1	1	1	0	1	1	0	1

7	6	5	4	3	2	1	0
1	0	1	0	1	0	0	0

Timing: M cycles — 4
 T states — 16 (4, 4, 3, 5)

Addressing Mode: Register Indirect

CPI

Compare data in memory location (HL) to the Accumulator, increment the memory pointer, and decrement the byte counter. The Z flag is set if the comparison is equal.

A - (HL) S: Set if result of comparison subtract is negative
 HL \leftarrow HL + 1 Z: Set if result of comparison is zero
 BC \leftarrow BC - 1 H: Set according to borrow from bit 4
 Z \leftarrow 1 P/V: Set if BC - 1 \neq 0, otherwise reset
 if A = (HL) N: Set
 C: N/A

7	6	5	4	3	2	1	0
1	1	1	0	1	1	0	1

7	6	5	4	3	2	1	0
1	0	1	0	0	0	0	1

Timing: M cycles — 4
 T states — 16 (4, 4, 3, 5)

Addressing Mode: Register Indirect

CPD

Compare data in memory location (HL) to the Accumulator, and decrement the memory pointer and byte counter. The Z flag is set if the comparison is equal.

A - (HL) S: Set if result is negative
 HL \leftarrow HL - 1 Z: Set if result of comparison is zero
 BC \leftarrow BC - 1 H: Set according to borrow from bit 4
 Z \leftarrow 1 P/V: Set if BC - 1 \neq 0, otherwise reset
 if A = (HL) N: Set
 C: N/A

12.11 Memory Block Moves and Searches (Continued)

7 6 5 4 3 2 1 0

1 1 1 0 1 1 0 1

1 0 1 0 1 0 0 1

Timing: M cycles — 4
T states — 16 (4, 4, 3, 5)

Addressing Mode: Register Indirect

REPEAT OPERATIONS

LDIR

Move data from memory location (HL) to memory location (DE), increment memory pointers, decrement byte counter BC, and repeat until BC = 0.

(DE) ← (HL) S: N/A

DE ← DE + 1 Z: N/A

HL ← HL + 1 H: Reset

BC ← BC - 1 P/V: Reset

Repeat until N: Reset

BC = 0 C: N/A

7 6 5 4 3 2 1 0

1 1 1 0 1 1 0 1

1 0 1 1 0 0 0 0

Timing: For BC ≠ 0 M cycles — 5
T states — 21 (4, 4, 3, 5, 5)

For BC = 0 M cycles — 4
T states — 16 (4, 4, 3, 5)

Addressing Mode: Register Indirect

(Note that each repeat is accomplished by a decrement of the BC, so that refresh, etc. continues for each cycle.)

LDDR

Move data from memory location (HL) to memory location (DE), decrement memory pointers and byte counter BC, and repeat until BC = 0.

(DE) ← (HL) S: N/A

DE ← DE - 1 Z: N/A

HL ← HL - 1 H: Reset

BC ← BC - 1 P/V: Reset

Repeat until N: Reset

BC = 0 C: N/A

7 6 5 4 3 2 1 0

1 1 1 0 1 1 0 1

1 0 1 1 1 0 0 0

Timing: For BC ≠ 0 M cycles — 5
T states — 21 (4, 4, 3, 5, 5)

For BC = 0 M cycles — 4
T states — 16 (4, 4, 3, 5)

Addressing Mode: Register Indirect

(Note that each repeat is accomplished by a decrement of the BC, so that refresh, etc. continues for each cycle.)

CPIR

Compare data in memory location (HL) to the Accumulator, increment the memory, decrement the byte counter BC, and repeat until BC = 0 or (HL) equals A.

A ← (HL)

HL ← HL + 1

BC ← BC - 1

Repeat until BC = 0

or A = (HL)

S: Set if sign of subtraction performed for comparison is negative

Z: Set if A = (HL), otherwise reset

H: Set according to borrow from bit 4

P/V: Set if BC - 1 ≠ 0, otherwise reset

N: Set

C: N/A

7 6 5 4 3 2 1 0

1 1 1 0 1 1 0 1

1 0 1 1 0 0 0 1

Timing: For BC ≠ 0 M cycles — 5
T states — 21 (4, 4, 3, 5, 5)

For BC = 0 M cycles — 4
T states — 16 (4, 4, 3, 5)

Addressing Mode: Register Indirect

(Note that each repeat is accomplished by a decrement of the PC, so that refresh, etc. continues for each cycle.)

CPDR

Compare data in memory location (HL) to the contents of the Accumulator, decrement the memory pointer and byte counter BC, and repeat until BC = 0, or until (HL) equals the Accumulator.

A ← (HL)

HL ← HL - 1

BC ← BC - 1

Repeat until BC = 0

or A = (HL)

S: Set if sign of subtraction performed for comparison is negative

Z: Set according to equality of A and (HL), set if true

H: Set according to borrow from bit 4

P/V: Set if BC - 1 ≠ 0, otherwise reset

N: Set

C: N/A

7 6 5 4 3 2 1 0

1 1 1 0 1 1 0 1

1 0 1 1 1 0 0 1

Timing: For BC ≠ 0 M cycles — 5
T states — 21 (4, 4, 3, 5, 5)

For BC = 0 M cycles — 4
T states — 16 (4, 4, 3, 5)

Addressing Mode: Register Indirect

(Note that each repeat is accomplished by a decrement of the BC, so that refresh, etc. continues for each cycle.)

12.12 Input/Output

IN A, (n)

Input data to the Accumulator from the I/O device at address N.

$A \leftarrow (n)$ No flags affected

7 6 5 4 3 2 1 0
1 1 0 1 1 0 1 1

1 1 0 1 1 0 1 1

n

Timing: M cycles — 3
T states — 11 (4, 3, 4)

Addressing Mode: Source — Direct
Destination — Register

IN r, (C)

Input data to register r from the I/O device addressed by the contents of register C. If r=110 only flags are affected.

$r \leftarrow (C)$ S: Set if result is negative
Z: Set if result is zero
H: Reset
P/V: Set if result parity is even

N: Reset

C: N/A

7 6 5 4 3 2 1 0

1 1 1 0 1 1 0 1

0 1 r 0 0 0

Timing: M cycles — 3
T states — 12 (4, 4, 4)

Addressing Mode: Source — Register Indirect
Destination — Register

OUT (C), r

Output register r to the I/O device addressed by the contents of register C.

$(C) \leftarrow r$ No flags affected

7 6 5 4 3 2 1 0

1 1 1 0 1 1 0 1

0 1 r 0 0 1

Timing: M cycles — 3
T states — 12 (4, 4, 4)

Addressing Mode: Source — Register
Destination — Register Indirect

INI

Input data from the I/O device addressed by the contents of register C to the memory location pointed to by the contents of the HL register. The HL pointer is incremented and the byte counter B is decremented.

$(HL) \leftarrow (C)$ S: Undefined
 $B \leftarrow B - 1$ Z: Set if $B-1=0$, otherwise reset
 $HL \leftarrow HL + 1$ H: Undefined

P/V: Undefined

N: Set

C: N/A

7 6 5 4 3 2 1 0

1 1 1 0 1 1 0 1

1 0 1 0 0 0 1 0

Timing: M cycles — 4
T states — 16 (4, 5, 3, 4)

Addressing Mode: Implied/Source — Register Indirect
Destination — Register Indirect

OUTI

Output data from memory location (HL) to the I/O device at port address (C), increment the memory pointer, and decrement the byte counter B.

$(C) \leftarrow (HL)$ S: Undefined
 $B \leftarrow B - 1$ Z: Set if $B-1=0$, otherwise reset
 $HL \leftarrow HL + 1$ H: Undefined

P/V: Undefined

N: Set

C: N/A

7 6 5 4 3 2 1 0

1 1 1 0 1 1 0 1

1 0 1 0 0 0 1 1

Timing: M cycles — 4
T states — 16 (4, 5, 3, 4)

Addressing Mode: Implied/Source — Register Indirect
Destination — Register Indirect

IND

Input data from I/O device at port address (C) to memory location (HL), and decrement HL memory pointer and byte counter B.

$(HL) \leftarrow (C)$ S: Undefined
 $HL \leftarrow HL - 1$ Z: Set if $B-1=0$, otherwise reset
 $B \leftarrow B - 1$ H: Undefined

P/V: Undefined

N: Set

C: N/A

7 6 5 4 3 2 1 0

1 1 1 0 1 1 0 1

1 0 1 0 1 0 1 0

Timing: M cycles — 4
T states — 16 (4, 5, 3, 4)

Addressing Mode: Implied/Source — Register Indirect
Destination — Register Indirect

12.12 Input/Output (Continued)

OUT (n), A

Output the Accumulator to the I/O device at address n.

(n) ← A No flags affected

7	6	5	4	3	2	1	0
1	1	0	1	0	0	1	1

n							
---	--	--	--	--	--	--	--

Timing: M cycles — 3
T states — 11 (4, 3, 4)

Addressing Mode: Source — Register
Destination — Direct

OUTD

Data is output from memory location (HL) to the I/O device at port address (C), and the HL memory pointer and byte counter B are decremented.

(C) ← (HL) S: Undefined
B ← B - 1 Z: Set if B - 1 = 0, otherwise reset

HL ← HL - 1 H: Undefined

P/V: Undefined

N: Set

C: N/A

7	6	5	4	3	2	1	0
1	1	1	0	1	1	0	1

7	6	5	4	3	2	1	0
1	0	1	0	1	0	1	1

Timing: M cycles — 4
T states — 16 (4, 5, 3, 4)

Addressing Mode: Implied/Source — Register Indirect
Destination — Register Indirect

INIR

Data is input from the I/O device at port address (C) to memory location (HL), the HL memory pointer is incremented, and the byte counter B is decremented. The cycle is repeated until B = 0.

(Note that B is tested for zero after it is decremented. By loading B initially with zero, 256 data transfers will take place.)

(HL) ← (C) S: Undefined

HL ← HL + 1 Z: Set

B ← B - 1 H: Undefined

Repeat until B = 0 P/V: Undefined

N: Set

C: N/A

7	6	5	4	3	2	1	0
1	1	1	0	1	1	0	1

7	6	5	4	3	2	1	0
1	0	1	1	0	0	1	0

Timing: For B ≠ 0 M cycles — 5
T states — 21 (4, 5, 3, 4, 5)

For B = 0 M cycles — 4

T states — 16 (4, 5, 3, 4)

Addressing Mode: Implied/Source — Register Indirect
Destination — Register Indirect

(Note that at the end of each data transfer cycle, interrupts may be recognized and two refresh cycles will be performed.)

OTIR

Data is output to the I/O device at port address (C) from memory location (HL), the HL memory pointer is incremented, and the byte counter B is decremented. The cycles are repeated until B = 0.

(Note that B is tested for zero after it is decremented. By loading B initially with zero, 256 data transfers will take place.)

(C) ← (HL) S: Undefined

HL ← HL + 1 H: Undefined

B ← B - 1 Z: Set

Repeat until B = 0 P/V: Undefined

N: Set

C: N/A

7	6	5	4	3	2	1	0
1	1	1	0	1	1	0	1

7	6	5	4	3	2	1	0
1	0	1	1	0	0	1	1

Timing: For B ≠ 0 M cycles — 5
T states — 21 (4, 5, 3, 4, 5)

For B = 0 M cycles — 4

T states — 16 (4, 5, 3, 4)

Addressing Mode: Implied/Source — Register Indirect
Destination — Register Indirect

(Note that at the end of each data transfer cycle, interrupts may be recognized and two refresh cycles will be performed.)

12.13 CPU Control (Continued)

IM 1

The CPU is placed in interrupt mode 1.

--- No flags affected

7 6 5 4 3 2 1 0
1 1 1 0 1 1 0 1

0 1 0 1 0 1 1 0

Timing: M cycles — 2
T states — 8 (4, 4)

Addressing Mode: N/A

IM 2

The CPU is placed in interrupt mode 2.

--- No flags affected

7 6 5 4 3 2 1 0
1 1 1 0 1 1 0 1

0 1 0 1 1 1 1 0

Timing: M cycles — 2
T states — 8 (4, 4)

Addressing Mode: N/A

12.14 Program Control

JUMPS

JP nn

Unconditional jump to program location nn.

PC ← nn No flags affected

7 6 5 4 3 2 1 0
1 1 0 0 0 0 1 1

n (low-order byte)

n (high-order byte)

Timing: M cycles — 3
T states — 10 (4, 3, 3)

Addressing Mode: Direct

JP (ss)

Unconditional jump to program location pointed to by register ss.

PC ← ss No flags affected

7 6 5 4 3 2 1 0
1 1 1 0 1 0 0 1 JP (HL)

Timing: M cycles — 1
T states — 4

Addressing Mode: Register Indirect

7 6 5 4 3 2 1 0

1 1 N_X 1 1 1 0 1

JP (IX) (for N_X = 0)

JP (IY) (for N_X = 1)

1 1 1 0 1 0 0 1

Timing: M cycles — 2
T states — 8 (4, 4)

Addressing Mode: Register Indirect

JP cc, nn

Conditionally jump to program location nn based on testable flag states.

If cc true, No flags affected

PC ← nn,

otherwise continue

7 6 5 4 3 2 1 0
1 1 cc 0 1 0

n (low-order byte)

n (high-order byte)

Timing: M cycles — 3
T states — 10 (4, 3, 3)

Addressing Mode: Direct

JR d

Unconditional jump to program location calculated with respect to the program counter and the displacement d.

PC ← PC + d No flags affected

7 6 5 4 3 2 1 0
0 0 0 1 1 0 0 0

d - 2

Timing: M cycles — 3
T states — 12 (4, 3, 5)

Addressing Mode: PC Relative

JR kk, d

Conditionally jump to program location calculated with respect to the program counter and the displacement d, based on limited testable flag states.

If kk true, No flags affected

PC ← PC + d,

otherwise continue

7 6 5 4 3 2 1 0
0 0 1 kk 0 0 0

d - 2

Timing: if kk met M cycles — 3
(true) T states — 12 (4, 3, 5)
if kk not met M cycles — 2
(not true) T states — 7 (4, 3)

Addressing Mode: PC Relative

12.14 Program Control (Continued)

DJNZ d

Decrement the B register and conditionally jump to program location calculated with respect to the program counter and the displacement d, based on the contents of the B register.

$B \leftarrow B - 1$ No flags affected

If $B = 0$ continue,

else $PC \leftarrow PC + d$

7	6	5	4	3	2	1	0
0	0	0	1	0	0	0	0

d - 2							
-------	--	--	--	--	--	--	--

Timing: If $B \neq 0$ M cycles — 3
T states — 13 (5, 3, 5)

If $B = 0$ M cycles — 2
T states — 8 (5, 3)

Addressing Mode: PC Relative

CALLS

CALL nn

Unconditional call to subroutine at location nn.

$(SP - 1) \leftarrow PC_H$ No flags affected

$(SP - 2) \leftarrow PC_L$

$SP \leftarrow SP - 2$

$PC \leftarrow nn$

7	6	5	4	3	2	1	0
1	1	0	0	1	1	0	1

n (low-order byte)							
--------------------	--	--	--	--	--	--	--

n (high-order byte)							
---------------------	--	--	--	--	--	--	--

Timing: M Cycles — 5
T states — 17 (4, 3, 4, 3, 3)

Addressing Mode: Direct

CALL cc, nn

Conditional call to subroutine at location nn based on testable flag stages.

If cc true, No flags affected

$(SP - 1) \leftarrow PC_H$

$(SP - 2) \leftarrow PC_L$

$SP \leftarrow SP - 2$

$PC \leftarrow nn$,

else continue

7	6	5	4	3	2	1	0
1	1	cc	1	0	0		

n (low-order byte)							
--------------------	--	--	--	--	--	--	--

n (high-order byte)							
---------------------	--	--	--	--	--	--	--

Timing: If cc true M cycles — 5
T states 17 (4, 3, 4, 3, 3)

If cc not true M cycles — 3
T states — 10 (4, 3, 3)

Addressing Mode: Direct

RETURNS

RET

Unconditional return from subroutine or other return to program location pointed to by the top of the stack.

$PC_L \leftarrow (SP)$ No flags affected

$PC_H \leftarrow (SP + 1)$

$SP \leftarrow SP + 2$

7	6	5	4	3	2	1	0
1	1	0	0	1	0	0	1

Timing: M cycles — 3
T states — 10 (4, 3, 3)

Addressing Mode: Register Indirect

RET cc

Conditional return from subroutine or other return to program location pointed to by the top of the stack.

If cc true, No flags affected

$PC_L \leftarrow (SP)$

$PC_H \leftarrow (SP + 1)$

$SP \leftarrow SP + 2$,

else continue

7	6	5	4	3	2	1	0
1	1	cc	0	0	0		

Timing: If cc true M cycles — 3
T states — 11 (5, 3, 3)

If cc not true M cycles — 1

T states — 5

Addressing Mode: Register Indirect

RETI

Unconditional return from interrupt handling subroutine. Functionally identical to RET instruction. Unique opcode allows monitoring by external hardware.

$PC_L \leftarrow (SP)$ No flags affected

$PC_H \leftarrow (SP + 1)$

$SP \leftarrow SP + 2$

7	6	5	4	3	2	1	0
1	1	1	0	1	1	0	1

0	1	0	0	1	1	0	1
---	---	---	---	---	---	---	---

Timing: M cycles — 4
T states — 14 (4, 4, 3, 3)

Addressing Mode: Register Indirect

12.14 Program Control (Continued)

RETN

Unconditional return from non-maskable interrupt handling subroutine. Functionally similar to RET instruction, except interrupt enable state is restored to that prior to non-maskable interrupt.

$PC_L \leftarrow (SP)$ No flags affected

$PC_H \leftarrow (SP + 1)$

$SP \leftarrow SP + 2$

$IFF_1 \leftarrow IFF_2$

7	6	5	4	3	2	1	0
1	1	1	0	1	1	0	1

0	1	0	0	0	1	0	1
---	---	---	---	---	---	---	---

Timing: M cycles — 4
T states — 14 (4, 4, 3, 3)

Addressing Mode: Register Indirect

RESTARTS

RST P

The present contents of the PC are pushed onto the memory stack and the PC is loaded with dedicated program locations as determined by the specific restart executed.

$(SP - 1) \leftarrow PC_H$ No flags affected

$(SP - 2) \leftarrow PC_L$

$SP \leftarrow SP - 2$

$PC_H \leftarrow 0$

$PC_L \leftarrow P$

7	6	5	4	3	2	1	0
1	1		t		1	1	1

Timing: M cycles — 3
T states — 11 (5, 3, 3)

Addressing Mode: Modified Page Zero

p	00H	08H	10H	18H	20H	28H	30H	38H
t	000	001	010	011	100	101	110	111

12.15 Instruction Set: Alphabetical Order

ADC	A, (HL)	8E	BIT	0, B	CB 40
ADC	A, (IX + d)	DD 8Ed	BIT	0, C	CB 41
ADC	A, (IY + d)	FD 8Ed	BIT	0, D	CB 42
ADC	A, A	8F	BIT	0, E	CB 43
ADC	A, B	88	BIT	0, H	CB 44
ADC	A, C	89	BIT	0, L	CB 45
ADC	A, D	8A	BIT	1, (HL)	CB 4E
ADC	A, E	8B	BIT	1, (IX + d)	DD CBd4E
ADC	A, H	8C	BIT	1, (IY + d)	FD CBd4E
ADC	A, L	8D	BIT	1, A	CB 4F
ADC	A, n	CE n	BIT	1, B	CB 48
ADC	HL, BC	ED 4A	BIT	1, C	CB 49
ADC	HL, DE	ED 5A	BIT	1, D	CB 4A
ADC	HL, HL	ED 6A	BIT	1, E	CB 4B
ADC	HL, SP	ED 7A	BIT	1, H	CB 4C
ADD	A, (HL)	86	BIT	1, L	CB 4D
ADD	A, (IX + d)	DD 86d	BIT	2, (HL)	CB 56
ADD	A, (IY + d)	FD 86d	BIT	2, (IX + d)	DD CBd56
ADD	A, A	87	BIT	2, (IY + d)	FD CBd56
ADD	A, B	80	BIT	2, A	CB 57
ADD	A, C	81	BIT	2, B	CB 50
ADD	A, D	82	BIT	2, C	CB 51
ADD	A, E	83	BIT	2, D	CB 52
ADD	A, H	84	BIT	2, E	CB 53
ADD	A, L	85	BIT	2, H	CB 54
ADD	A, n	C6 n	BIT	2, L	CB 55
ADD	HL, BC	09	BIT	3, (HL)	CB 5E
ADD	HL, DE	19	BIT	3, (IX + d)	DD CBd5E
ADD	HL, HL	29	BIT	3, (IY + d)	FD CBd5E
ADD	HL, SP	39	BIT	3, A	CB 5F
ADD	IX, BC	DD 09	BIT	3, B	CB 58
ADD	IX, DE	DD 19	BIT	3, C	CB 59
ADD	IX, IX	DD 29	BIT	3, D	CB 5A
ADD	IX, SP	DD 39	BIT	3, E	CB 5B
ADD	IY, BC	FD 09	BIT	3, H	CB 5C
ADD	IY, DE	FD 19	BIT	3, L	CB 5D
ADD	IY, IY	FD 29	BIT	4, (HL)	CB 66
ADD	IY, SP	FD 39	BIT	4, (IX + d)	DD CBd66
AND	(HL)	A6	BIT	4, (IY + d)	FD CBd66
AND	(IX + d)	DD A6d	BIT	4, A	CB 67
AND	(IY + d)	FD A6d	BIT	4, B	CB 60
AND	A	A7	BIT	4, C	CB 61
AND	B	A0	BIT	4, D	CB 62
AND	C	A1	BIT	4, E	CB 63
AND	D	A2	BIT	4, H	CB 64
AND	E	A3	BIT	4, L	CB 65
AND	H	A4	BIT	5, (HL)	CB 6E
AND	L	A5	BIT	5, (IX + d)	DD CBd6E
AND	n	E6 n	BIT	5, (IY + d)	FD CBd6E
BIT	0, (HL)	CB 46	BIT	5, A	CB 6F
BIT	0, (IX + d)	DD CBd46	BIT	5, B	CB 68
BIT	0, (IY + d)	FD CBd46	BIT	5, C	CB 69
BIT	0, A	CB 47	BIT	5, D	CB 6A

(nn) = address of memory location

d = signed displacement

nn = Data (16 bit)

d2 = d - 2

n = Data (8 bit)

12.15 Instruction Set: Alphabetical Order (Continued)

BIT	5, E	CB 6B	DEC	A	3D
BIT	5, H	CB 6C	DEC	B	05
BIT	5, L	CB 6D	DEC	BC	0B
BIT	6, (HL)	CB 76	DEC	C	0D
BIT	6, (IX + d)	DD CBd76	DEC	D	15
BIT	6, (IY + d)	FD CBd76	DEC	DE	1B
BIT	6, A	CB 77	DEC	E	1D
BIT	6, B	CB 70	DEC	H	25
BIT	6, C	CB 71	DEC	HL	2B
BIT	6, D	CB 72	DEC	IX	DD 2B
BIT	6, E	CB 73	DEC	IY	FD 2B
BIT	6, H	CB 74	DEC	L	2D
BIT	6, L	CB 75	DEC	SP	3B
BIT	7, (HL)	CB 7E	DI		F3
BIT	7, (IX + d)	DD CBd7E	DJNZ	d2	10 d2
BIT	7, (IY + d)	FD CBd7E	EI		FB
BIT	7, A	CB 7F	EX	(SP), HL	E3
BIT	7, B	CB 78	EX	(SP), IX	DD E3
BIT	7, C	CB 79	EX	(SP), IY	FD E3
BIT	7, D	CB 7A	EX	AF, A'F'	08
BIT	7, E	CB 7B	EX	DE, HL	EB
BIT	7, H	CB 7C	EXX		D9
BIT	7, L	CB 7D	HALT		76
CALL	C, nn	DCnn	IM	0	ED 46
CALL	M, nn	FCnn	IM	1	ED 56
CALL	NC, nn	D4nn	IM	2	ED 5E
CALL	nn	CDnn	IN	A, (C)	ED78
CALL	NZ, nn	C4nn	IN	A, (n)	DB n
CALL	P, nn	F4nn	IN	B, (C)	ED 40
CALL	PE, nn	ECnn	IN	C, (C)	ED 48
CALL	PO, nn	E4nn	IN	D, (C)	ED 50
CALL	Z, nn	CCnn	IN	E, (C)	ED 58
CCF		3F	IN	H, (C)	ED 60
CP	(HL)	BE	IN	L, (C)	ED 68
CP	(IX + d)	DD BEd	INC	(HL)	34
CP	(IY + d)	FD BEd	INC	(IX + d)	DD 34d
CP	A	BF	INC	(IY + d)	FD 34d
CP	B	B8	INC	A	3C
CP	C	B9	INC	B	04
CP	D	BA	INC	BC	03
CP	E	BB	INC	C	0C
CP	H	BC	INC	D	14
CP	L	BD	INC	DE	13
CP	n	FE n	INC	E	1C
CPD		ED A9	INC	H	24
CPDR		ED B9	INC	HL	23
CPI		ED A1	INC	IX	DD 23
CPIR		ED B1	INC	IY	FD 23
CPL		2F	INC	L	2C
DAA		27	INC	SP	33
DEC	(HL)	35	IND		ED AA
DEC	(IX + d)	DD 35d	INDR		ED BA
DEC	(IY + d)	FD 35d	INI		ED A2

(nn) = Address of memory location

d = signed displacement

nn = Data (16 bit)

d2 = d - 2

n = Data (8 bit)

12.15 Instruction Set: Alphabetical Order (Continued)

INIR		ED B2	LD	A, (HL)	7E
JP	(HL)	E9	LD	A, (IX + d)	DD 7Ed
JP	(IX)	DD E9	LD	A, (IY + d)	FD 7Ed
JP	(IY)	FD E9	LD	A, (nn)	3Ann
JP	C, nn	DAnn	LD	A, A	7F
JP	M, nn	FAnn	LD	A, B	78
JP	NC, nn	D2nn	LD	A, C	79
JP	nn	C3nn	LD	A, D	7A
JP	NZ, nn	C2nn	LD	A, E	7B
JP	P, nn	F2nn	LD	A, H	7C
JP	PE, nn	EAnn	LD	A, I	ED 57
JP	PO, nn	E2nn	LD	A, L	7D
JP	Z, nn	CAnn	LD	A, n	3E n
JR	C, d2	38 d2	LD	B, (HL)	46
JR	d2	18 d2	LD	B, (IX + d)	DD 46d
JR	NC, d2	30 d2	LD	B, (IY + d)	FD 46d
JR	NZ, d2	20 d2	LD	B, A	47
JR	Z, d2	28 d2	LD	B, B	40
LD	(BC), A	02	LD	B, C	41
LD	(DE), A	12	LD	B, D	42
LD	(HL), A	77	LD	B, E	43
LD	(HL), B	70	LD	B, H	44
LD	(HL), C	71	LD	B, L	45
LD	(HL), D	72	LD	B, n	06 n
LD	(HL), E	73	LD	BC, (nn)	ED 4B
LD	(HL), H	74	LD	BC, nn	01nn
LD	(HL), L	75	LD	C, (HL)	4E
LD	(HL), n	36 n	LD	C, (IX + d)	DD 4Ed
LD	(IX + d), A	DD 77d	LD	C, (IY + d)	FD 4Ed
LD	(IX + d), B	DD 70d	LD	C, A	4F
LD	(IX + d), C	DD 71d	LD	C, B	48
LD	(IX + d), D	DD 72d	LD	C, C	49
LD	(IX + d), E	DD 73d	LD	C, D	4A
LD	(IX + d), H	DD 74d	LD	C, E	4B
LD	(IX + d), L	DD 75d	LD	C, H	4C
LD	(IX + d), n	DD 36dn	LD	C, L	4D
LD	(IY + d), A	FD 77d	LD	C, n	0E n
LD	(IY + d), B	FD 70d	LD	D, (HL)	56
LD	(IY + d), C	FD 71d	LD	D, (IX + d)	DD 56d
LD	(IY + d), D	FD 72d	LD	D, (IY + d)	FD 56d
LD	(IY + d), E	FD 73d	LD	D, A	57
LD	(IY + d), H	FD 74d	LD	D, B	50
LD	(IY + d), L	FD 75d	LD	D, C	51
LD	(IY + d), n	FD 36dn	LD	D, D	52
LD	(nn), A	32nn	LD	D, E	53
LD	(nn), BC	ED 43nn	LD	D, H	54
LD	(nn), DE	ED 53nn	LD	D, L	55
LD	(nn), HL	22nn	LD	D, n	16 n
LD	(nn), IX	DD 22nn	LD	DE, (nn)	ED 5Bnn
LD	(nn), IY	FD 22nn	LD	DE, nn	11nn
LD	(nn), SP	ED 73nn	LD	E, (HL)	5E
LD	A, (BC)	0A	LD	E, (IX + d)	DD 5Ed
LD	A, (DE)	1A	LD	E, (IY + d)	FD 5Ed

(nn) = Address of memory location

d = signed displacement

nn = Data (16 bit)

d2 = d - 2

n = Data (8 bit)

12.15 Instruction Set: Alphabetical Order (Continued)

LD	E, A	5F	OR	C	B1
LD	E, B	58	OR	D	B2
LD	E, C	59	OR	E	B3
LD	E, D	5A	OR	H	B4
LD	E, E	5B	OR	L	B5
LD	E, H	5C	OR	n	F6 n
LD	E, L	5D	OTDR		ED BB
LD	E, n	1E n	OTIR		ED B3
LD	H, (HL)	66	OUT	(C), A	ED 79
LD	H, (IX + d)	DD 66d	OUT	(C), B	ED 41
LD	H, (IY + d)	FD 66d	OUT	(C), C	ED 49
LD	H, A	67	OUT	(C), D	ED 51
LD	H, B	60	OUT	(C), E	ED 59
LD	H, C	61	OUT	(C), H	ED 61
LD	H, D	62	OUT	(C), L	ED 69
LD	H, E	63	OUT	n, A	D3 n
LD	H, H	64	OUTD		ED AB
LD	H, L	65	OUTI		ED A3
LD	H, n	26 n	POP	AF	F1
LD	HL, (nn)	2Ann	POP	BC	C1
LD	HL, nn	21nn	POP	DE	D1
LD	I, A	ED 47	POP	HL	E1
LD	IX, (nn)	DD 2Ann	POP	IX	DD E1
LD	IX, nn	DD 21nn	POP	IY	FD E1
LD	IY, (nn)	FD 2Ann	PUSH	AF	F5
LD	IY, nn	FD 21nn	PUSH	BC	C5
LD	L, (HL)	6E	PUSH	DE	D5
LD	L, (IX + d)	DD 6Ed	PUSH	HL	E5
LD	L, (IY + d)	FD 6Ed	PUSH	IX	DD E5
LD	L, A	6F	PUSH	IY	FD E5
LD	L, B	68	RES	0, (HL)	CB 86
LD	L, C	69	RES	0, (IX + d)	DD CBd86
LD	L, D	6A	RES	0, (IY + d)	FD CBd86
LD	L, E	6B	RES	0, A	CB 87
LD	L, H	6C	RES	0, B	CB 80
LD	L, L	6D	RES	0, C	CB 81
LD	L, n	2E n	RES	0, D	CB 82
LD	SP, (nn)	ED 7Bnn	RES	0, E	CB 83
LD	SP, HL	F9	RES	0, H	CB 84
LD	SP, IX	DD F9	RES	0, L	CB 85
LD	SP, IY	FD F9	RES	1, (HL)	CB 8E
LD	SP, nn	31nn	RES	1, (IX + d)	DD CBd8E
LDD		ED A8	RES	1, (IY + d)	FD CBd8E
LDDR		ED B8	RES	1, A	CB 8F
LDI		ED A0	RES	1, B	CB 88
LDIR		ED B0	RES	1, C	CB 89
NEG		ED n	RES	1, D	CB 8A
NOP		00	RES	1, E	CB 8B
OR	(HL)	B6	RES	1, H	CB 8C
OR	(IX + d)	DD B6d	RES	1, L	CB 8D
OR	(IY + d)	FD B6d	RES	2, (HL)	CB 96
OR	A	B7	RES	2, (IX + d)	DD CBd96
OR	B	B0	RES	2, (IY + d)	FD CBd96

(nn) = Address of memory location d = signed displacement
 nn = Data (16 bit) d2 = d - 2
 n = Data (8 bit)

12.15 Instruction Set: Alphabetical Order (Continued)

RES	2, A	CB 97	RES	7, D	CB BA
RES	2, B	CB 90	RES	7, E	CB BB
RES	2, C	CB 91	RES	7, H	CB BC
RES	2, D	CB 92	RES	7, L	CB BD
RES	2, E	CB 93	RET		C9
RES	2, H	CB 94	RET	C	D8
RES	2, L	CB 95	RET	M	F8
RES	3, (HL)	CB 9E	RET	NC	D0
RES	3, (IX + d)	DD CBd9E	RET	NZ	C0
RES	3, (IY + d)	FD CBd9E	RET	P	F0
RES	3, A	CB 9F	RET	PE	E8
RES	3, B	CB 98	RET	PO	E0
RES	3, C	CB 99	RET	Z	C8
RES	3, D	CB 9A	RETI		ED 4D
RES	3, E	CB 9B	RETN		ED 45
RES	3, H	CB 9C	RL	(HL)	CB 16
RES	3, L	CB 9D	RL	(IX + d)	DD CBd16
RES	4, (HL)	CB A6	RL	(IY + d)	FD CBd16
RES	4, (IX + d)	DD CBdA6	RL	A	CB 17
RES	4, (IY + d)	FD CBdA6	RL	B	CB 10
RES	4, A	CB A7	RL	C	CB 11
RES	4, B	CB A0	RL	D	CB 12
RES	4, C	CB A1	RL	E	CB 13
RES	4, D	CB A2	RL	H	CB 14
RES	4, E	CB A3	RL	L	CB 15
RES	4, H	CB A4	RLA		17
RES	4, L	CB A5	RLC	(HL)	CB 06
RES	5, (HL)	CB AE	RLC	(IX + d)	DD CBd06
RES	5, (IX + d)	DD CBdAE	RLC	(IY + d)	FD CBd06
RES	5, (IY + d)	FD CBdAE	RLC	A	CB 07
RES	5, A	CB AF	RLC	B	CB 00
RES	5, B	CB A8	RLC	C	CB 01
RES	5, C	CB A9	RLC	D	CB 02
RES	5, D	CB AA	RLC	E	CB 03
RES	5, E	CB AB	RLC	H	CB 04
RES	5, H	CB AC	RLC	L	CB 05
RES	5, L	CB AD	RLCA		07
RES	6, (HL)	CB B6	RLD		ED 6F
RES	6, (IX + d)	DD CBdB6	RR	(HL)	CB 1E
RES	6, (IY + d)	FD CBdB6	RR	(IX + d)	DD CBd1E
RES	6, A	CB B7	RR	(IY + d)	FD CBd1E
RES	6, B	CB B0	RR	A	CB 1F
RES	6, C	CB B1	RR	B	CB 18
RES	6, D	CB B2	RR	C	CB 19
RES	6, E	CB B3	RR	D	CB 1A
RES	6, H	CB B4	RR	E	CB 1B
RES	6, L	CB B5	RR	H	CB 1C
RES	7, (HL)	CB BE	RR	L	CB 1D
RES	7, (IX + d)	DD CBdBE	RRA		1F
RES	7, (IY + d)	FD CBdBE	RRC	(HL)	CB 0E
RES	7, A	CB BF	RRC	(IX + d)	DD CBd0E
RES	7, B	CB B8	RRC	(IY + d)	FD CBd0E
RES	7, C	CB B9	RRC	A	CB 0F

(nn) = Address of memory location

d = signed displacement

nn = Data (16 bit)

d2 = d - 2

n = Data (8 bit)

12.15 Instruction Set: Alphabetical Order (Continued)

RRC	B	CB 08	SET	2, (IX + d)	DD CBdD6
RRC	C	CB 09	SET	2, (IY + d)	FD CBdD6
RRC	D	CB 0A	SET	2, A	CB D7
RRC	E	CB 0B	SET	2, B	CB D0
RRC	H	CB 0C	SET	2, C	CB D1
RRC	L	CB 0D	SET	2, D	CB D2
RRCA		0F	SET	2, E	CB D3
RRD		ED 67	SET	2, H	CB D4
RST	0	C7	SET	2, L	CB D5
RST	08H	CF	SET	3, (HL)	CB DE
RST	10H	D7	SET	3, (IX + d)	DD CBdDE
RST	18H	DF	SET	3, (IY + d)	FD CBdDE
RST	20H	E7	SET	3, A	CB DF
RST	28H	EF	SET	3, B	CB D8
RST	30H	F7	SET	3, C	CB D9
RST	38H	FF	SET	3, D	CB DA
SBC	A, (HL)	9E	SET	3, E	CB DB
SBC	A, (IX + d)	DD 9Ed	SET	3, H	CB DC
SBC	A, (IY + d)	FD 9Ed	SET	3, L	CB DD
SBC	A, A	9F	SET	4, (HL)	CB E6
SBC	A, B	98	SET	4, (IX + d)	DD CBdE6
SBC	A, C	99	SET	4, (IY + d)	FD CBdE6
SBC	A, D	9A	SET	4, A	CB E7
SBC	A, E	9B	SET	4, B	CB E0
SBC	A, H	9C	SET	4, C	CB E1
SBC	A, L	9D	SET	4, D	CB E2
SBC	A, n	DE n	SET	4, E	CB E3
SBC	HL, BC	ED 42	SET	4, H	CB E4
SBC	HL, DE	ED 52	SET	4, L	CB E5
SBC	HL, HL	ED 62	SET	5, (HL)	CB EE
SBC	HL, SP	ED 72	SET	5, (IX + d)	DD CBdEE
SCF		37	SET	5, (IY + d)	FD CBdEE
SET	0, (HL)	CB C6	SET	5, A	CB EF
SET	0, (IX + d)	DD CBdC6	SET	5, B	CB E8
SET	0, (IY + d)	FD CBdC6	SET	5, C	CB E9
SET	0, A	CB C7	SET	5, D	CB EA
SET	0, B	CB C0	SET	5, E	CB EB
SET	0, C	CB C1	SET	5, H	CB EC
SET	0, D	CB C2	SET	5, L	CB ED
SET	0, E	CB C3	SET	6, (HL)	CB F6
SET	0, H	CB C4	SET	6, (IX + d)	DD CBdF6
SET	0, L	CB C5	SET	6, (IY + d)	FD CBdF6
SET	1, (HL)	CB CE	SET	6, A	CB F7
SET	1, (IX + d)	DD CBdCE	SET	6, B	CB F0
SET	1, (IY + d)	FD CBdCE	SET	6, C	CB F1
SET	1, A	CB CF	SET	6, D	CB F2
SET	1, B	CB C8	SET	6, E	CB F3
SET	1, C	CB C9	SET	6, H	CB F4
SET	1, D	CB CA	SET	6, L	CB F5
SET	1, E	CB CB	SET	7, (HL)	CB FE
SET	1, H	CB CC	SET	7, (IX + d)	DD CBdFE
SET	1, L	CB CD	SET	7, (IY + d)	FD CBdFE
SET	2, (HL)	CB D6	SET	7, A	CB FF

(nn) = Address of memory location d = displacement
 nn = Data (16 bit) d2 = d - 2
 n = Data (8 bit)

12.15 Instruction Set: Alphabetical Order (Continued)

SET	7, B	CB F8	SRL	A	CB 3F
SET	7, C	CB F9	SRL	B	CB 38
SET	7, D	CB FA	SRL	C	CB 39
SET	7, E	CB FB	SRL	D	CB 3A
SET	7, H	CB FC	SRL	E	CB 3B
SET	7, L	CB FD	SRL	H	CB 3C
SLA	(HL)	CB 26	SRL	L	CB 3D
SLA	(IX + d)	DD CBd26	SUB	(HL)	96
SLA	(IY + d)	FD CBd26	SUB	(IX + d)	DD 96d
SLA	A	CB 27	SUB	(IY + d)	FD 96d
SLA	B	CB 20	SUB	A	97
SLA	C	CB 21	SUB	B	90
SLA	D	CB 22	SUB	C	91
SLA	E	CB 23	SUB	D	92
SLA	H	CB 24	SUB	E	93
SLA	L	CB 25	SUB	H	94
SRA	(HL)	CB 2E	SUB	L	95
SRA	(IX + d)	DD CBd2E	SUB	n	D6 n
SRA	(IY + d)	FD CBd2E	XOR	(HL)	AE
SRA	A	CB 2F	XOR	(IX + d)	DD AEd
SRA	B	CB 28	XOR	(IY + d)	FD AEd
SRA	C	CB 29	XOR	A	AF
SRA	D	CB 2A	XOR	B	A8
SRA	E	CB 2B	XOR	C	A9
SRA	H	CB 2C	XOR	D	AA
SRA	L	CB 2D	XOR	E	AB
SRL	(HL)	CB 3E	XOR	H	AC
SRL	(IX + d)	DD CBd3E	XOR	L	AD
SRL	(IY + d)	FD CBd3E	XOR	n	EE n

12.16 Instruction Set: Numerical Order

Op Code	Mnemonic	Op Code	Mnemonic	Op Code	Mnemonic
00	NOP	15	DEC D	2Ann	LD HL,(nn)
01nn	LD BC,nn	16n	LD D,n	2B	DEC HL
02	LD (BC),A	17	RLA	2C	INC L
03	INC BC	18d2	JR d2	2D	DEC L
04	INC B	19	ADD HL,DE	2En	LD L,n
05	DEC B	1A	LD A,(DE)	2F	CPL
06n	LD B,n	1B	DEC DE	30d2	JR NC,d2
07	RLCA	1C	INC E	31nn	LD SP,nn
08	EX AF,A'F'	1D	DEC E	32nn	LD (nn),A
09	ADD HL,BC	1En	LD E,n	33	INC SP
0A	LD A,(BC)	1F	RRA	34	INC (HL)
0B	DEC BC	20d2	JR NZ,d2	35	DEC (HL)
0C	INC C	21nn	LD HL,nn	36n	LD (HL),n
0D	DEC C	22nn	LD (nn),HL	37	SCF
0En	LD C,n	23	INC HL	38	JR C,d2
0F	RRCA	24	INC H	39	ADD HL,SP
10d2	DJNZ d2	25	DEC H	3Ann	LD A,(nn)
11nn	LD DE,nn	26n	LD H, n	3B	DEC SP
12	LD (DE),A	27	DAA	3C	INC A
13	INC DE	28d2	JR Z,d2	3D	DEC A
14	INC D	29	ADD HL,HL	3En	LD A,n

(nn) = Address of memory location

nn = Data (16 bit)

n = Data (8 bit)

d = displacement

d2 = d - 2

12.16 Instruction Set: Numerical Order (Continued)

Op Code	Mnemonic	Op Code	Mnemonic	Op Code	Mnemonic
3F	CCF	74	LD (HL),H	A9	XOR C
40	LD B,B	75	LD (HL),L	AA	XOR D
41	LD B,C	76	HALT	AB	XOR E
42	LD B,D	77	LD (HL),A	AC	XOR H
43	LD B,E	78	LD A,B	AD	XOR L
44	LD B,H	79	LD A,C	AE	XOR (HL)
45	LD B,L	7A	LD A,D	AF	XOR A
46	LD B,(HL)	7B	LD A,E	B0	OR B
47	LD B,A	7C	LD A,H	B1	OR C
48	LD C,B	7D	LD A,L	B2	OR D
49	LD C,C	7E	LD A,(HL)	B3	OR E
4A	LD C,D	7F	LD A,A	B4	OR H
4B	LD C,E	80	ADD A,B	B5	OR L
4C	LD C,H	81	ADD A,C	B6	OR (HL)
4D	LD C,L	82	ADD A,D	B7	OR A
4E	LD C,(HL)	83	ADD A,E	B8	CP B
4F	LD C,A	84	ADD A,H	B9	CP C
50	LD D,B	85	ADD A,L	BA	CP D
51	LD D,C	86	ADD A,(HL)	BB	CP E
52	LD D,D	87	ADD A,A	BC	CP H
53	LD D,E	88	ADC A,B	BD	CP L
54	LD D,H	89	ADC A,C	BE	CP (HL)
55	LD D,L	8A	ADC A,D	BF	CP A
56	LD D,(HL)	8B	ADC A,E	C0	RET NZ
57	LD D,A	8C	ADC A,H	C1	POP BC
58	LD E,B	8D	ADC A,L	C2nn	JP NZ,nn
59	LD E,C	8E	ADC A,(HL)	C3nn	JP nn
5A	LD E,D	8F	ADC A,A	C4nn	CALL NZ,nn
5B	LD E,E	90	SUB B	C5	PUSH BC
5C	LD E,H	91	SUB C	C6n	ADD A,n
5D	LD E,L	92	SUB D	C7	RST 0
5E	LD E,(HL)	93	SUB E	C8	RET Z
5F	LD E,A	94	SUB H	C9	RET
60	LD H,B	95	SUB L	CAnn	JP Z,nn
61	LD H,C	96	SUB (HL)	CB00	RLC B
62	LD H,D	97	SUB A	CB01	RLC C
63	LD H,E	98	SBC A,B	CB02	RLC D
64	LD H,H	99	SBC A,C	CB03	RLC E
65	LD H,L	9A	SBC A,D	CB04	RLC H
66	LD H,(HL)	9B	SBC A,E	CB05	RLC L
67	LD H,A	9C	SBC A,H	CB06	RLC (HL)
68	LD L,B	9D	SBC A,L	CB07	RLC A
69	LD L,C	9E	SBC A,(HL)	CB08	RRC B
6A	LD L,D	9F	SBC A,A	CB09	RRC C
6B	LD L,E	A0	AND B	CB0A	RRC D
6C	LD L,H	A1	AND C	CB0B	RRC E
6D	LD L,L	A2	AND D	CB0C	RRC H
6E	LD L,(HL)	A3	AND E	CB0D	RRC L
6F	LD L,A	A4	AND H	CB0E	RRC (HL)
70	LD (HL),B	A5	AND L	CB0F	RRC A
71	LD (HL),C	A6	AND (HL)	CB10	RL B
72	LD (HL),D	A7	AND A	CB11	RL C
73	LD (HL),E	A8	XOR B	CB12	RL D

(nn) = Address of memory location d = displacement
nn = Data (16 bit) d2 = d - 2
n = Data (8-bit)

12.16 Instruction Set: Numerical Order (Continued)

Op Code	Mnemonic	Op Code	Mnemonic	Op Code	Mnemonic
CB13	RL E	CB4F	BIT 1,A	CB83	RES 0,E
CB14	RL H	CB50	BIT 2,B	CB84	RES 0,H
CB15	RL L	CB51	BIT 2,C	CB85	RES 0,L
CB16	RL (HL)	CB52	BIT 2,D	CB86	RES 0,(HL)
CB17	RL A	CB53	BIT 2,E	CB87	RES 0,A
CB18	RR B	CB54	BIT 2,H	CB88	RES 1,B
CB19	RR C	CB55	BIT 2,L	CB89	RES 1,C
CB1A	RR D	CB56	BIT 2,(HL)	CB8A	RES 1,D
CB1B	RR E	CB57	BIT 2,A	CB8B	RES 1,E
CB1C	RR H	CB58	BIT 3,B	CB8C	RES 1,H
CB1D	RR L	CB59	BIT 3,C	CB8D	RES 1,L
CB1E	RR (HL)	CB5A	BIT 3,D	CB8E	RES 1,(HL)
CB1F	RR A	CB5B	BIT 3,E	CB8F	RES 1,A
CB20	SLA B	CB5C	BIT 3,H	CB90	RES 2,B
CB21	SLA C	CB5D	BIT 3,L	CB91	RES 2,C
CB22	SLA D	CB5E	BIT 3,(HL)	CB92	RES 2,D
CB23	SLA E	CB5F	BIT 3,A	CB93	RES 2,E
CB24	SLA H	CB60	BIT 4,B	CB94	RES 2,H
CB25	SLA L	CB61	BIT 4,C	CB95	RES 2,L
CB26	SLA (HL)	CB62	BIT 4,D	CB96	RES 2,(HL)
CB27	SLA A	CB63	BIT 4,E	CB97	RES 2,A
CB28	SRA B	CB64	BIT 4,H	CB98	RES 3,B
CB29	SRA C	CB65	BIT 4,L	CB99	RES 3,C
CB2A	SRA D	CB66	BIT 4,(HL)	CB9A	RES 3,D
CB2B	SRA E	CB67	BIT 4,A	CB9B	RES 3,E
CB2C	SRA H	CB68	BIT 5,B	CB9C	RES 3,H
CB2D	SRA L	CB69	BIT 5,C	CB9D	RES 3,L
CB2E	SRA (HL)	CB6A	BIT 5,D	CB9E	RES 3,(HL)
CB2F	SRA A	CB6B	BIT 5,E	CB9F	RES 3,A
CB38	SRL B	CB6C	BIT 5,H	CBA0	RES 4,B
CB39	SRL C	CB6D	BIT 5,L	CBA1	RES 4,C
CB3A	SRL D	CB6E	BIT 5,(HL)	CBA2	RES 4,D
CB3B	SRL E	CB6F	BIT 5,A	CBA3	RES 4,E
CB3C	SRL H	CB70	BIT 6,B	CBA4	RES 4,H
CB3D	SRL L	CB71	BIT 6,C	CBA5	RES 4,L
CB3E	SRL (HL)	CB72	BIT 6,D	CBA6	RES 4,(HL)
CB3F	SRL A	CB73	BIT 6,E	CBA7	RES 4,A
CB40	BIT 0,B	CB74	BIT 6,H	CBA8	RES 5,B
CB41	BIT 0,C	CB75	BIT 6,L	CBA9	RES 5,C
CB42	BIT 0,D	CB76	BIT 6,(HL)	CBAA	RES 5,D
CB43	BIT 0,E	CB77	BIT 6,A	CBAB	RES 5,E
CB44	BIT 0,H	CB78	BIT 7,B	CBAC	RES 5,H
CB45	BIT 0,L	CB79	BIT 7,C	CBAD	RES 5,L
CB46	BIT 0,(HL)	CB7A	BIT 7,D	CBAE	RES 5,(HL)
CB47	BIT 0,A	CB7B	BIT 7,E	CBAF	RES 5,A
CB48	BIT 1,B	CB7C	BIT 7,H	CBB0	RES 6,B
CB49	BIT 1,C	CB7D	BIT 7,L	CBB1	RES 6,C
CB4A	BIT 1,D	CB7E	BIT 7,(HL)	CBB2	RES 6,D
CB4B	BIT 1,E	CB7F	BIT 7,A	CBB3	RES 6,E
CB4C	BIT 1,H	CB80	RES 0,B	CBB4	RES 6,H
CB4D	BIT 1,L	CB81	RES 0,C	CBB5	RES 6,L
CB4E	BIT 1,(HL)	CB82	RES 0,D	CBB6	RES 6,(HL)

(nn) = Address of memory location d = displacement
 nn = Data (16 bit) d2 = d - 2
 n = Data (8-bit)

12.16 Instruction Set: Numerical Order (Continued)

Op Code	Mnemonic	Op Code	Mnemonic	Op Code	Mnemonic
CBB7	RES 6,A	CBEC	SET 5,H	DD66d	LD H,(IX + d)
CBB8	RES 7,B	CBED	SET 5,L	DD6Ed	LD L,(IX + d)
CBB9	RES 7,C	CBEE	SET 5,(HL)	DD70d	LD (IX + d),B
CBBA	RES 7,D	CBEF	SET 5,A	DD71d	LD (IX + d),C
CBBB	RES 7,E	CBF0	SET 6,B	DD72d	LD (IX + d),D
CBBC	RES 7,H	CBF1	SET 6,C	DD73d	LD (IX + d),E
CBBD	RES 7,L	CBF2	SET 6,D	DD74d	LD (IX + d),H
CBBE	RES 7,(HL)	CBF3	SET 6,E	DD75d	LD (IX + d),L
CBBF	RES 7,A	CBF4	SET 6,H	DD77d	LD (IX + d),A
CBC0	SET 0,B	CBF5	SET 6,L	DD7Ed	LD A,(IX + d)
CBC1	SET 0,C	CBF6	SET 6,(HL)	DD86d	ADD A,(IX + d)
CBC2	SET 0,D	CBF7	SET 6,A	DD8Ed	ADC A,(IX + d)
CBC3	SET 0,E	CBF8	SET 7,B	DD96d	SUB (IX + d)
CBC4	SET 0,H	CBF9	SET 7,C	DD9Ed	SBC A,(IX + d)
CBC5	SET 0,L	CBFA	SET 7,D	DDA6d	AND (IX + d)
CBC6	SET 0,(HL)	CBFB	SET 7,E	DDAEd	XOR (IX + d)
CBC7	SET 0,A	CBFC	SET 7,H	DDB6d	OR (IX + d)
CBC8	SET 1,B	CBFD	SET 7,L	DDBEd	CP (IX + d)
CBC9	SET 1,C	CBFE	SET 7,(HL)	DDCBd06	RLC (IX + d)
CBCA	SET 1,D	CBFF	SET 7,A	DDCBd0E	RRC (IX + d)
CBCB	SET 1,E	CCnn	CALL Z,nn	DDCBd16	RL (IX + d)
CBCc	SET 1,H	CDnn	CALL nn	DDCBd1E	RR (IX + d)
CBCD	SET 1,L	CEn	ADC A,n	DDCBd26	SLA (IX + d)
CBCE	SET 1,(HL)	CF	RST 8	DDCBd2E	SRA (IX + d)
CBCF	SET 1,A	D0	RET NC	DDCBd3E	SRL (IX + d)
CBD0	SET 2,B	D1	POP DE	DDCBd46	BIT 0,(IX + d)
CBD1	SET 2,C	D2nn	JP NC,nn	DDCBd4E	BIT 1,(IX + d)
CBD2	SET 2,D	D3n	OUT (n),A	DDCBd56	BIT 2,(IX + d)
CBD3	SET 2,E	D4nn	CALL NC,nn	DDCBd5E	BIT 3,(IX + d)
CBD4	SET 2,H	D5	PUSH DE	DDCBd66	BIT 4,(IX + d)
CBD5	SET 2,L	D6n	SUB n	DDCBd6E	BIT 5,(IX + d)
CBD6	SET 2,(HL)	D7	RST 10H	DDCBd76	BIT 6,(IX + d)
CBD7	SET 2,A	D8	RET C	DDCBd7E	BIT 7,(IX + d)
CBD8	SET 3,B	D9	EXX	DDCBd86	RES 0,(IX + d)
CBD9	SET 3,C	DAnn	JP C,nn	DDCBd8E	RES 1,(IX + d)
CBDA	SET 3,D	DBn	IN A,(n)	DDCBd96	RES 2,(IX + d)
CBDB	SET 3,E	DCnn	CALL C,nn	DDCBd9E	RES 3,(IX + d)
CBDC	SET 3,H	DD09	ADD IX,BC	DDCBdA6	RES 4,(IX + d)
CBDd	SET 3,L	DD19	ADD IX,DE	DDCBdAE	RES 5,(IX + d)
CBDE	SET 3,(HL)	DD21nn	LD IX,nn	DDCBdB6	RES 6,(IX + d)
CBDF	SET 3,A	DD22nn	LD (nn),IX	DDCBdBE	RES 7,(IX + d)
CBE0	SET 4,B	DD23	INC IX	DDCBdC6	SET 0,(IX + d)
CBE1	SET 4,C	DD29	ADD IX,IX	DDCBdCE	SET 1,(IX + d)
CBE2	SET 4,D	DD2Ann	LD IX,(nn)	DDCBdD6	SET 2,(IX + d)
CBE3	SET 4,E	DD2B	DEC IX	DDCBdDE	SET 3,(IX + d)
CBE4	SET 4,H	DD34d	INC (IX + d)	DDCBdE6	SET 4,(IX + d)
CBE5	SET 4,L	DD35d	DEC (IX + d)	DDCBdEE	SET 5,(IX + d)
CBE6	SET 4,(HL)	DD36dn	LD (IX + d),n	DDCBdF6	SET 6,(IX + d)
CBE7	SET 4,A	DD39	ADD IX,SP	DDCBdFE	SET 7,(IX + d)
CBE8	SET 5,B	DD46d	LD B,(IX + d)	DDE1	POP IX
CBE9	SET 5,C	DD4Ed	LD C,(IX + d)	DDE3	EX (SP),IX
CBEA	SET 5,D	DD56d	LD D,(IX + d)	DDE5	PUSH IX
CBEb	SET 5,E	DD5Ed	LD E,(IX + d)	DDE9	JP (IX)

(nn) = Address of memory location d = displacement
 nn = Data (16 bit) d2 = d - 2
 n = Data (8-bit)

12.16 Instruction Set: Numerical Order (Continued)

Op Code	Mnemonic	Op Code	Mnemonic	Op Code	Mnemonic
DDF9	LD SP,IX	ED7Bnn	LD SP,(nn)	FD73d	LD (IY + d),E
DEn	SCB A,n	EDA0	LDI	FD74d	LD (IY + d),H
DF	RST 18H	EDA1	CPI	FD75d	LD (IY + d),L
E0	RET PO	EDA2	INI	FD77d	LD (IY + d),A
E1	POP HL	EDA3	OUTI	FD7Ed	LD A,(IY + d)
E2nn	JP PO,nn	EDA8	LDD	FD86d	ADD A,(IY + d)
E3	EX (SP),HL	EDA9	CPD	FD8Ed	ADC A,(IY + d)
E4nn	CALL PO,nn	EDAA	IND	FD96d	SUB (IY + d)
E5	PUSH HL	EDAB	OUTD	FD9Ed	SBC A,(IY + d)
E6n	AND n	EDB0	LDIR	FDA6d	AND (IY + d)
E7	RST 20H	EDB1	CPIR	FDAEd	XOR (IY + d)
E8	RET PE	EDB2	INIR	FDB6d	OR (IY + d)
E9	JP (HL)	EDB3	OTIR	FDBEd	CP (IY + d)
EAnn	JP PE,nn	EDB8	LDDR	FDE1	POP IY
EB	EX DE,HL	EDB9	CPDR	FDE3	EX (SP), IY
ECnn	CALL PE,nn	EDBA	INDR	FDE5	PUSH IY
ED40	IN B,(C)	EDBB	OTDR	FDE9	JP (IY)
ED41	OUT (C),B	EE n	XOR n	FDF9	LD SP,IY
ED42	SBC HL,BC	EF	RST 28H	FDCBd06	RLC (IY + d)
ED43nn	LD (nn),BC	F0	RET P	FDCBd0E	RRC (IY + d)
ED44	NEG	F1	POP AF	FDCBd16	RL (IY + d)
ED45	RETN	F2nn	JP P,nn	FDCBd1E	RR (IY + d)
ED46	IM 0	F3	DI	FDCBd26	SLA (IY + d)
ED47	LD I,A	F4nn	CALL P,nn	FDCBd2E	SRA (IY + d)
ED48	IN C,(C)	F5	PUSH AF	FDCBd3E	SRL (IY + d)
ED49	OUT (C),C	F6n	OR n	FDCBd46	BIT 0,(IY + d)
ED4A	ADC HL,BC	F7	RST 30H	FDCBd4E	BIT 1,(IY + d)
ED4Bnn	LD BC,(nn)	F8	RET M	FDCBd56	BIT 2,(IY + d)
ED4D	RETI	F9	LD SP,HL	FDCBd5E	BIT 3,(IY + d)
ED50	IN D,(C)	FAnn	JP M,nn	FDCBd66	BIT 4,(IY + d)
ED51	OUT (C),D	FB	EI	FDCBd6E	BIT 5,(IY + d)
ED52	SBC HL,DE	FCnn	CALL M,nn	FDCBd76	BIT 6,(IY + d)
ED53nn	LD (nn),DE	FD09	ADD IY,BC	FDCBd7E	BIT 7,(IY + d)
ED56	IM 1	FD19	ADD IY,DE	FDCBd86	RES 0,(IY + d)
ED57	LD A,I	FD21nn	LD IY,nn	FDCBd8E	RES 1,(IY + d)
ED58	IN E,(C)	FD22nn	LD (nn),IY	FDCBd96	RES 2,(IY + d)
ED59	OUT (C), E	FD23	INC IY	FDCBd9E	RES 3,(IY + d)
ED5A	ADC HL,DE	FD29	ADD IY,IY	FDCBdA6	RES 4,(IY + d)
ED5Bnn	LD DE,(nn)	FD2Ann	LD IY,(nn)	FDCBdAE	RES 5,(IY + d)
ED5E	IM 2	FD2B	DEC IY	FDCBdB6	RES 6,(IY + d)
ED60	IN H,(C)	FD34d	INC (IY + d)	FDCBdBE	RES 7,(IY + d)
ED61	OUT (C),H	FD35d	DEC (IY + d)	FDCBdC6	SET 0,(IY + d)
ED62	SBC HL,HL	FD36dn	LD (IY + d),n	FDCBdCE	SET 1,(IY + d)
ED67	RRD	FD39	ADD IY,SP	FDCBdD6	SET 2,(IY + d)
ED68	IN L,(C)	FD46d	LD B,(IY + d)	FDCBdDE	SET 3,(IY + d)
ED69	OUT (C),L	FD4Ed	LD C,(IY + d)	FDCBdE6	SET 4,(IY + d)
ED6A	ADC HL,HL	FD56d	LD D,(IY + d)	FDCBdEE	SET 5,(IY + d)
ED6F	RLD	FD5Ed	LD E,(IY + d)	FDCBdF6	SET 6,(IY + d)
ED72	SBC HL,SP	FD66d	LD H,(IY + d)	FDCBdFE	SET 7,(IY + d)
ED73nn	LD (nn),SP	FD6Ed	LD L,(IY + d)	FEn	CP n
ED78	IN A,(C)	FD70d	LD (IY + d),B	FF	RST 38H
ED79	OUT (C),A	FD71d	LD (IY + d),C		
ED7A	ADC HL,SP	FD72d	LD (IY + d),D		

(nn) = Address of memory location d = displacement
 nn = Data (16 bit) d2 = d - 2
 n = Data (8-bit)

13.0 Data Acquisition System

A natural application for the NSC800 is one that requires remote operation. Since power consumption is low if the system consists of only CMOS components, the entire package can conceivably operate from only a battery power source. In the application described herein, the only source of power will be from a battery pack composed of a stacked array of NiCad batteries (see *Figure 20*).

The application is that of a remote data acquisition system. Extensive use is made of some of the other LSI CMOS components manufactured by National: notably the ADC0816 and MM58167. The ADC0816 is a 16-channel analog-to-digital converter which operates from a 5V source. The MM58167 is a microprocessor-compatible real-time clock (RTC). The schematic for this system is shown in *Figure 20*. All the necessary features of the system are contained in six integrated circuits: NSC800, NSC810A, NSC831, HN6136P, ADC0816, and MM58167. Some other small scale integration CMOS components are used for normal interface requirements. To reduce component count, linear selection techniques are used to generate chip selects for the NSC810A and NSC831. Included also is a current loop communication link to enable the remote system to transfer data collected to a host system.

In order to keep component count low and maximize effectiveness, many of the features of the NSC800 family have been utilized. The RAM section of the NSC810A is used as a data buffer to store intermediate measurements and as scratch pad memory for calculations. Both timers contained in the NSC810A are used to produce the clocks required by the A/D converter and the RTC. The Power-Save feature of the NSC800 makes it possible to reduce system power consumption when it is not necessary to collect any data. One of the analog input channels of the A/D is connected to the battery pack to enable the CPU to monitor its own voltage supply and notify the host that a battery change is needed.

In operation, the NSC800 makes readings on various input conditions through the ADC0816. The type of devices connected to the A/D input depends on the nature of the remote environment. For example, the duties of the remote system might be to monitor temperature variations in a large building. In this case, the analog inputs would be connected to temperature transducers. If the system is situated in a process control environment, it might be monitoring fluid flow, temperatures, fluid levels, etc. In either case, operation would be necessary even if a power failure occurred, thus

the need for battery operation or at least battery backup. At some fixed times or at some particular time durations, the system takes readings by selecting one of the analog input channels, commands the A/D to perform a conversion, reads the data, and then formats it for transmission; or, the system checks the readings against set points and transmits a warning if the set points are exceeded. With the addition of the RTC, the host need not command the remote system to take these readings each time it is necessary. The NSC800 could simply set up the RTC to interrupt it at a previously defined time and when the interrupt occurs, make the readings. The resultant values could be stored in the NSC810A for later correlation. In the example of temperature monitoring in a building, it might be desired to know the high and low temperatures for a 12-hour period. After compiling the information, the system could dump the data to the host over the communications link. Note from the schematic that the current for the communication link is supplied by the host to remove the constant current drain from the battery supply.

The required clocks for the two peripheral devices are generated by the two timers in the NSC810A. Through the use of various divisors, the master clock generated by the NSC800 is divided down to produce the clocks. Four examples are shown in the table following *Figure 20*.

All the crystal frequencies are standard frequencies. The various divisors listed are selected to produce, from the master clock frequency of the NSC800, an exact 32,768 Hz clock for the MM58167 and a clock within the operating range of the A/D converter.

The MM58167 is a programmable real-time clock that is microprocessor compatible. Its data format is BCD. It allows the system to program its interrupt register to produce an interrupt output either on a time of day match (which includes the day of the week, the date and month) and/or every month, week, day, hour, minute, second, or tenth of a second. With this capability added to the system, precise time of day measurements are possible without having the CPU do timekeeping. The interrupt output can be connected, through the use of one port bit of the NSC810A, to put the CPU in the power-save mode and reenable it at a preset time. The interrupt output is also connected to one of the hardware restart inputs (RSTB) to enable time duration measurements. This power-down mode of operation would not be possible if the NSC800 had the duties of timekeep-

13.0 Data Acquisition System (Continued)

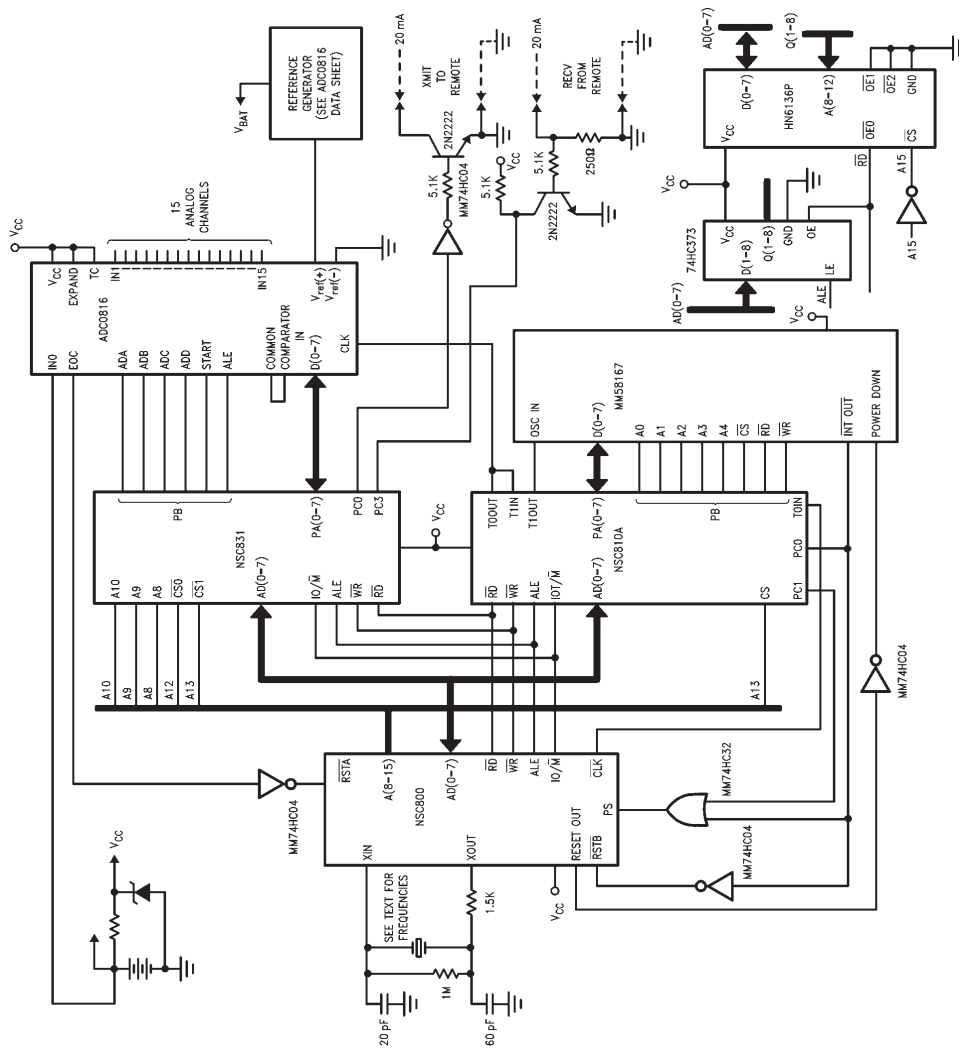

TL/O/5171-84

FIGURE 20. Remote Data Acquisition

13.0 Data Acquisition System (Continued)

ing. When in the power-save mode, the system power requirements are decreased by about 50%, thus extending battery life.

Communication with the peripheral devices (MM58167 and ADC0816) is accomplished through the I/O ports of the NSC810A and NSC831. The peripheral devices are not connected to the bus of the NSC800 as they are not directly compatible with a multiplexed bus structure. Therefore, additional components would be required to place them on the microprocessor bus. Writing data into the MM58167 is performed by first putting the desired data on Port A, followed by selecting the address of the internal register and applying the chip select through the use of Port B. A bit set and clear operation is performed to emulate a pulse on the bit of Port B connected to the \overline{WR} input of the MM58167. For a read operation, the same sequence of operations is performed except that Port A is set for the input mode of operation and the \overline{RD} line is pulsed. Similar techniques are used to read converted data from the A/D converter. When a conversion is desired, the CPU selects a channel and commands the ADC0816 to start a conversion. When the conversion is complete, the converter will produce an End-of-Conversion

signal which is connected to the \overline{RSTA} interrupt input of the NSC800.

When operating, the system shown consumes about 125 mw. When in the power-save mode, power consumption is decreased to about 70 mw. If, as is likely, the system is in the power-save mode most of the time, battery life can be quite long depending on the amp-hour rating of the batteries incorporated into the system. For example, if the battery pack is rated at 5 amp-hours, the system should be able to operate for about 400-500 hours before a battery charge or change is required.

As shown in the schematic (refer to *Figure 20*), analog input IN0 is connected to the battery source. In this way, the CPU can monitor its own power source and notify the host that it needs a battery replacement or charge. Since the battery source shown is a stacked array of 7 NiCads producing 8.4V, the converter input is connected in the middle so that it can take a reading on two or three of the cells. Since NiCad batteries have a relatively constant voltage output until very nearly discharged, the CPU can sense that the "knee" of the discharge curve has been reached and notify the host.

Typical Timer Output Frequencies

Crystal Frequency	CPU Clock Output	Timer 0 Output	Timer 1 Output
2.097152 MHz	1.048576 MHz	262.144 kHz divisor = 4	32.768 kHz divisor = 8
3.276800 MHz	1.638400 MHz	327.680 kHz divisor = 5	32.768 kHz divisor = 10
4.194304 MHz	2.097152 MHz	262.144 kHz divisor = 8	32.768 kHz divisor = 8
4.915200 MHz	2.457600 MHz	491.520 kHz divisor = 5	32.768 kHz divisor = 15

14.0 NSC800M/883B MIL-STD-833 Class C Screening

National Semiconductor offers the NSC800D and NSC800E with full class B screening per MIL-STD-883 for Military/Aerospace programs requiring high reliability. In addition, this screening is available for all of the key NSC800 peripheral devices.

Electrical testing is performed in accordance with RETS800X, which tests or guarantees all of the electrical performance characteristics of the NSC800 data sheet. A copy of the current revision of RETS800X is available upon request.

100% Screening Flow

Test	MIL-STD-883 Method/Condition	Requirement
Internal Visual	2010B	100%
Stabilization Bake	1008 C 24 Hrs. @ +150°C	100%
Temperature Cycling	1010 C 10 Cycles -65°C/+150°C	100%
Constant Acceleration	2001 E 30,000 G's, Y1 Axis	100%
Fine Leak	1014 A or B	100%
Gross Leak	1014C	100%
Burn-In	1015 160 Hrs. @ +125°C (using burn-in circuits shown below)	100%
Final Electrical PDA	+25°C DC per RETS800X 10% Max +125°C AC and DC per RETS800X -55°C AC and DC per RETS800X +25°C AC per RETS800X	100% 100% 100% 100%
QA Acceptance Quality Conformance	5005	Sample Per Method 5005
External Visual	2009	100%

15.0 Burn-In Circuits

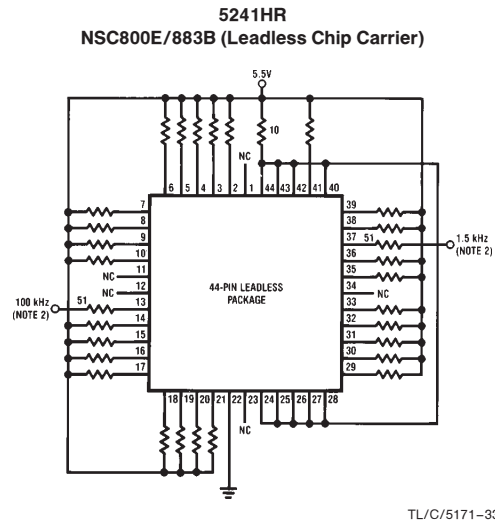
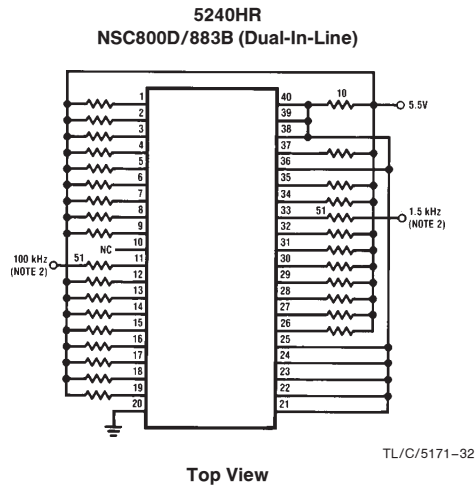

All resistors 2.7 k Ω unless marked otherwise.

Note 1: All resistors are 1/4W \pm 5% unless otherwise specified.

Note 2: All clocks 0V to 3V, 50% duty cycle, in phase with $< 1 \mu$ s rise and fall time.

Note 3: Device to be cooled down under power after burn-in.

16.0 Ordering Information

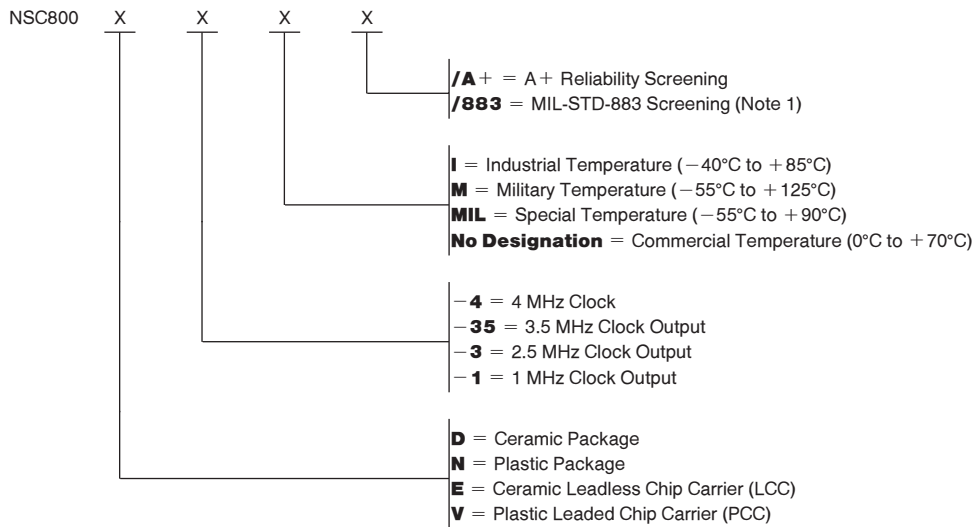

Note 1: Do not specify a temperature option; all parts are screened to military temperature.

17.0 Reliability Information

Gate Count 2750

Transistor Count 11,000

Physical Dimensions inches (millimeters)

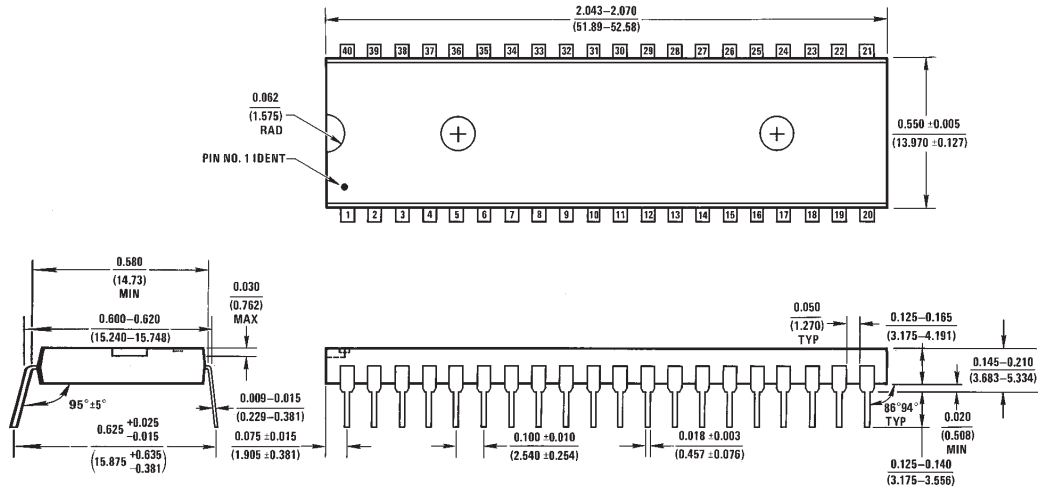

Molded Dual-In-Line Package (N)
Order Number NSC800N
NS Package Number N40A

NADA (REV E)

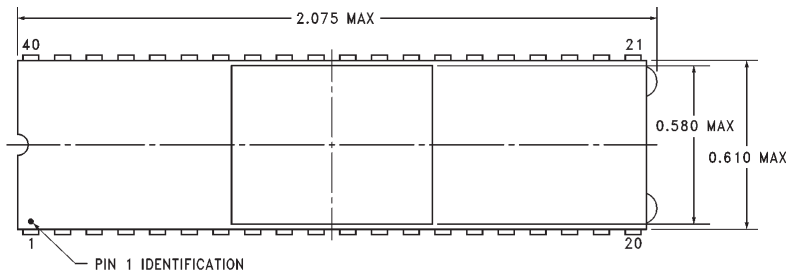

Hermetic Dual-In-Line Package (D)
Order Number NSC800D
NS Package Number D40C

D40C (REV J)

Physical Dimensions inches (millimeters) (Continued)

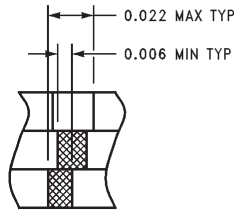
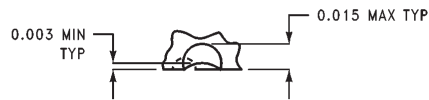
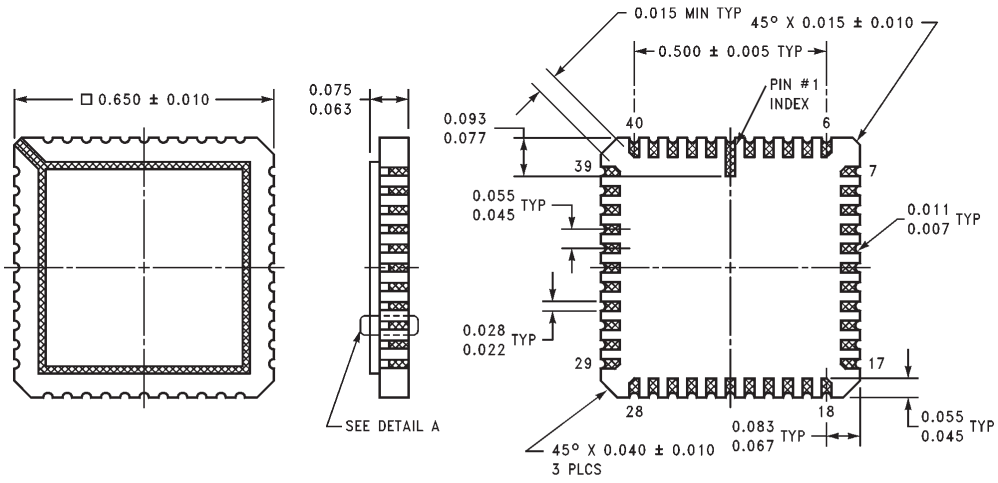

DETAIL A

Leadless Chip Carrier Package (E)
Order Number NSC800E
NS Package Number E44A

E44A (REV E)

Physical Dimensions inches (millimeters) (Continued)

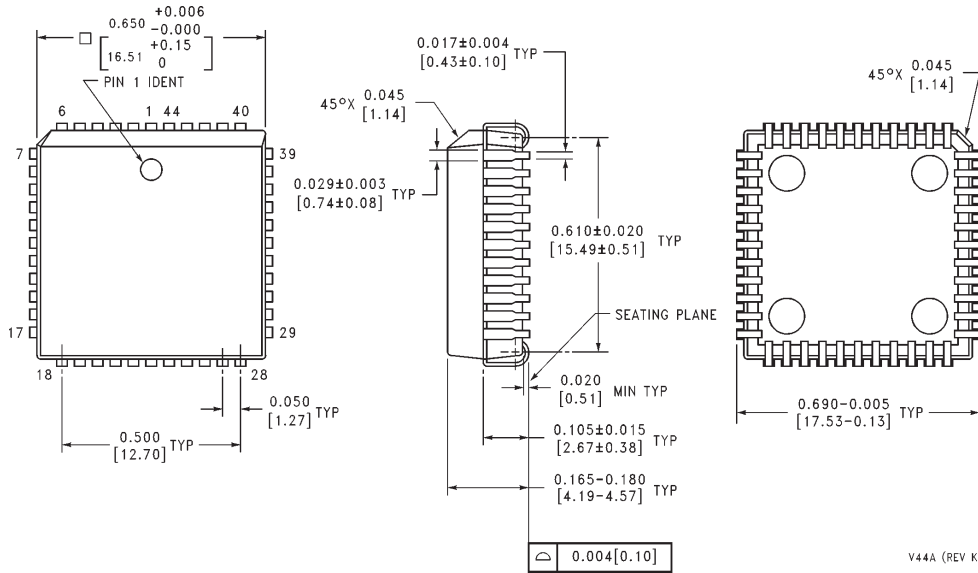

**Plastic Chip Carrier (V)
Order Number NSC800V
NS Package Number V44A**

V44A (REV K)

LIFE SUPPORT POLICY

NATIONAL'S PRODUCTS ARE NOT AUTHORIZED FOR USE AS CRITICAL COMPONENTS IN LIFE SUPPORT DEVICES OR SYSTEMS WITHOUT THE EXPRESS WRITTEN APPROVAL OF THE PRESIDENT OF NATIONAL SEMICONDUCTOR CORPORATION. As used herein:

1. Life support devices or systems are devices or systems which, (a) are intended for surgical implant into the body, or (b) support or sustain life, and whose failure to perform, when properly used in accordance with instructions for use provided in the labeling, can be reasonably expected to result in a significant injury to the user.
2. A critical component is any component of a life support device or system whose failure to perform can be reasonably expected to cause the failure of the life support device or system, or to affect its safety or effectiveness.



National Semiconductor Corporation
1111 West Bardin Road
Arlington, TX 76017
Tel: 1(800) 272-9959
Fax: 1(800) 737-7018

National Semiconductor Europe
Fax: (+49) 0-180-530 85 86
Email: cnjwge@tevm2.nsc.com
Deutsch Tel: (+49) 0-180-530 85 85
English Tel: (+49) 0-180-532 78 32
Français Tel: (+49) 0-180-532 93 58
Italiano Tel: (+49) 0-180-534 16 80

National Semiconductor Hong Kong Ltd.
19th Floor, Straight Block,
Ocean Centre, 5 Canton Rd.
Tsimshatsui, Kowloon
Hong Kong
Tel: (852) 2737-1600
Fax: (852) 2736-9960

National Semiconductor Japan Ltd.
Tel: 81-043-299-2309
Fax: 81-043-299-2408

National does not assume any responsibility for use of any circuitry described, no circuit patent licenses are implied and National reserves the right at any time without notice to change said circuitry and specifications.