

12-Bit, 130MSPS, High Speed D/A Converter

The HI5860 is a 12-bit, 130MSPS (Mega Samples Per Second), high speed, low power, D/A converter which is implemented in an advanced CMOS process. Operating from a single +3V to +5V supply, the converter provides 20mA of full scale output current and includes edge-triggered CMOS input data latches. Low glitch energy and excellent frequency domain performance are achieved using a segmented current source architecture.

This device complements the HI5x60 and HI5x28 family of high speed converters, which includes 8-, 10-, 12-, and 14-bit devices.

Pinout

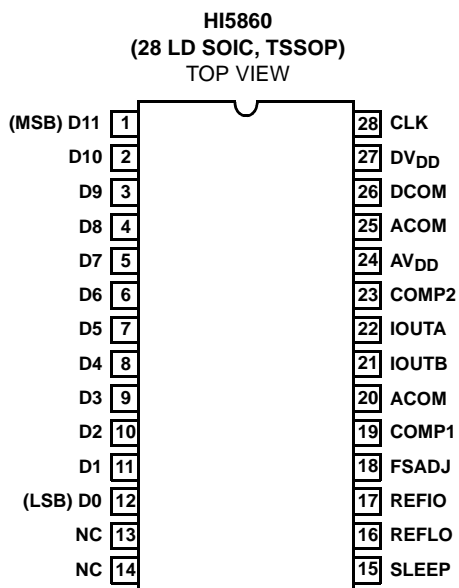

Features

- Throughput Rate 130MSPS
- Low Power . . . 175mW at 5V, 32mW at 3V (At 100MSPS)
- Integral Linearity Error (Typ) ±0.5 LSB
- Adjustable Full Scale Output Current 2mA to 20mA
- Internal 1.2V Bandgap Voltage Reference
- Single Power Supply from +5V to +3V
- Power-Down Mode
- CMOS Compatible Inputs
- Excellent Spurious Free Dynamic Range (76dBc, f_S = 50MSPS, f_{OUT} = 2.51MHz)
- Excellent Multitone Intermodulation Distortion
- Pb-Free Available (RoHS Compliant)

Applications

- Basestations (Cellular, WLL)
- Medical/Test Instrumentation
- Wireless Communications Systems
- Direct Digital Frequency Synthesis
- Signal Reconstruction
- High Resolution Imaging Systems
- Arbitrary Waveform Generators

Ordering Information

PART NUMBER	PART MARKING	TEMP. RANGE (°C)	PACKAGE	PKG. DWG. #	CLOCK SPEED
HI5860IA*	HI5860 IA	-40 to +85	28 Ld TSSOP	M28.173	130MHz
HI5860IB	HI5860IB	-40 to +85	28 Ld SOIC	M28.3	130MHz
HI5860IBZ* (Note)	HI5860IBZ	-40 to +85	28 Ld SOIC (Pb-free)	M28.3	130MHz
HI5860SOICEVAL1		+25	Evaluation Platform		130MHz

*Add "-T" suffix for tape and reel. Please refer to TB347 for details on reel specifications.

NOTE: These Intersil Pb-free plastic packaged products employ special Pb-free material sets; molding compounds/die attach materials and 100% matte tin plate PLUS ANNEAL - e3 termination finish, which is RoHS compliant and compatible with both SnPb and Pb-free soldering operations. Intersil Pb-free products are MSL classified at Pb-free peak reflow temperatures that meet or exceed the Pb-free requirements of IPC/JEDEC J STD-020.

Pin Descriptions

PIN NUMBER	PIN NAME	PIN DESCRIPTION
1 through 12	D11 (MSB) Through D0 (LSB)	Digital Data Bit 11, (Most Significant Bit) through Digital Data Bit 0, (Least Significant Bit).
13,14	NC	No Connect. (Available as 2 additional LSBs on the HI5960, 14-bit device).
15	SLEEP	Control Pin for Power-Down Mode. Sleep Mode is active high; connect to ground for Normal Mode. Sleep pin has internal 20 μ A active pull-down current.
16	REFLO	Connect to analog ground to enable internal 1.2V reference or connect to AV _{DD} to disable internal reference.
17	REFIO	Reference voltage input if internal reference is disabled. Reference voltage output if internal reference is enabled. Use 0.1 μ F cap to ground when internal reference is enabled.
18	FSADJ	Full Scale Current Adjust. Use a resistor to ground to adjust full scale output current. Full Scale Output Current = $32 \times V_{FSADJ}/R_{SET}$.
19	COMP1	For use in reducing bandwidth/noise. Recommended: Connect 0.1 μ F to AV _{DD} .
21	IOUTB	The complementary current output of the device. Full scale output current is achieved when all input bits are set to binary 0.
22	IOUTA	Current output of the device. Full scale output current is achieved when all input bits are set to binary 1.
23	COMP2	Connect 0.1 μ F capacitor to ACOM.
24	AV _{DD}	Analog Supply (+2.7V to +5.5V).
20, 25	ACOM	Connect to Analog Ground.
26	DCOM	Connect to Digital Ground.
27	DV _{DD}	Digital Supply (+2.7V to +5.5V).
28	CLK	Clock Input. Input data to the DAC passes through the "master" latches when the clock is low and is latched into the "master" latches when the clock is high. Data presented to the "slave" latch passes through when the clock is logic high and is latched into the "slave" latches when the clock is logic low. Adequate setup time must be allowed for the MSBs to pass through the thermometer decoder before the clock goes high. This master-slave arrangement comprises an edge-triggered flip-flop, with the DAC being updated on the rising clock edge. For optimum spectral performance, it is recommended that the clock edge be skewed such that set-up time is larger than the hold time.

Absolute Maximum Ratings

Digital Supply Voltage DV_{DD} to DCOM	+5.5V
Analog Supply Voltage AV_{DD} to ACOM	+5.5V
Grounds, ACOM TO DCOM	-0.3V to +0.3V
Digital Input Voltages (D11-D0, CLK, SLEEP)	$DV_{DD} + 0.3V$
Reference Input Voltage Range	$AV_{DD} + 0.3V$
Analog Output Current (I_{OUT})	24mA

Thermal Information

Thermal Resistance (Typical, Note 1)	θ_{JA} (°C/W)
SOIC Package	75
TSSOP Package	100
Maximum Junction Temperature	+150°C
Maximum Storage Temperature Range	-65°C to +150°C
Pb-free reflow profile	see link below
http://www.intersil.com/pbfree/Pb-FreeReflow.asp	

Operating Conditions

Temperature Range	-40°C to +85°C
-------------------	----------------

CAUTION: Do not operate at or near the maximum ratings listed for extended periods of time. Exposure to such conditions may adversely impact product reliability and result in failures not covered by warranty.

NOTE:

- θ_{JA} is measured with the component mounted on an evaluation PC board in free air.

Electrical Specifications $AV_{DD} = DV_{DD} = +5V$ (except where otherwise noted), $V_{REF} = \text{Internal } 1.2V$, $I_{OUTFS} = 20mA$, $T_A = -40^\circ C$ to $+85^\circ C$, $T_A = +25^\circ C$ for All Typical Values.

PARAMETER	TEST CONDITIONS	MIN (Note10)	TYP	MAX (Note 10)	UNITS
SYSTEM PERFORMANCE					
Resolution		12	-	-	Bits
Integral Linearity Error, INL	"Best Fit" Straight Line (Note 8)	-2.0	±0.5	+2.0	LSB
Differential Linearity Error, DNL	(Note 8)	-1.0	±0.5	+1.0	LSB
Offset Error, I_{OS}	(Note 8)	-0.025	-	+0.025	% FSR
Offset Drift Coefficient	(Note 8)	-	0.1	-	ppm FSR/°C
Full Scale Gain Error, FSE	With External Reference (Notes 2, 8)	-10	±2	+10	% FSR
	With Internal Reference (Notes 2, 8)	-10	±1	+10	% FSR
Full Scale Gain Drift	With External Reference (Note 8)	-	±50	-	ppm FSR/°C
	With Internal Reference (Note 8)	-	±100	-	ppm FSR/°C
Full Scale Output Current, I_{FS}		2	-	20	mA
Output Voltage Compliance Range	(Notes 3, 8)	-0.3	-	1.25	V
DYNAMIC CHARACTERISTICS					
Maximum Clock Rate, f_{CLK}	(Note 3)	130	-	-	MHz
Output Settling Time, (t_{SETT})	±0.05% (±2 LSB) (Note 8)	-	35	-	ns
Singlet Glitch Area (Peak Glitch)	$R_L = 25\Omega$ (Note 8)	-	5	-	pV*s
Output Rise Time	Full Scale Step	-	2.5	-	ns
Output Fall Time	Full Scale Step	-	2.5	-	ns
Output Capacitance		-	10	-	pF
Output Noise	$I_{OUTFS} = 20mA$	-	50	-	$\mu A/\sqrt{Hz}$
	$I_{OUTFS} = 2mA$	-	30	-	$\mu A/\sqrt{Hz}$

Electrical Specifications $V_{DD} = DV_{DD} = +5V$ (except where otherwise noted), $V_{REF} = \text{Internal } 1.2V$, $I_{OUTFS} = 20mA$,
 $T_A = -40^\circ C$ to $+85^\circ C$, $T_A = +25^\circ C$ for All Typical Values. **(Continued)**

PARAMETER	TEST CONDITIONS	MIN (Note10)	TYP	MAX (Note 10)	UNITS
AC CHARACTERISTICS					
+5V Power Supply Spurious Free Dynamic Range, SFDR Within a Window	$f_{CLK} = 100MSPS, f_{OUT} = 20.2MHz, 10MHz \text{ Span (Notes 4, 8)}$	-	77	-	dBc
	$f_{CLK} = 100MSPS, f_{OUT} = 5.04MHz, 4MHz \text{ Span (Notes 4, 8)}$	-	95	-	dBc
	$f_{CLK} = 50MSPS, f_{OUT} = 5.02MHz, 2MHz \text{ Span (Notes 4, 8)}$	-	95	-	dBc
+5V Power Supply Total Harmonic Distortion (THD) to Nyquist	$f_{CLK} = 100MSPS, f_{OUT} = 4.0MHz \text{ (Notes 4, 8)}$	-	-71	-	dBc
	$f_{CLK} = 50MSPS, f_{OUT} = 2.0MHz \text{ (Notes 4, 8)}$	-	-75	-	dBc
	$f_{CLK} = 25MSPS, f_{OUT} = 1.0MHz \text{ (Notes 4, 8)}$	-	-76	-	dBc
+5V Power Supply Spurious Free Dynamic Range, SFDR to Nyquist ($f_{CLK}/2$)	$f_{CLK} = 130MSPS, f_{OUT} = 40.4MHz \text{ (Notes 4, 8)}$	-	55	-	dBc
	$f_{CLK} = 130MSPS, f_{OUT} = 10.1MHz \text{ (Notes 4, 8)}$	-	66	-	dBc
	$f_{CLK} = 130MSPS, f_{OUT} = 5.02MHz, T = +25^\circ C \text{ (Notes 4, 8)}$	68	74	-	dBc
	$f_{CLK} = 130MSPS, f_{OUT} = 5.02MHz, T = \text{Min to Max (Notes 4, 8)}$	66	-	-	dBc
	$f_{CLK} = 100MSPS, f_{OUT} = 40.4MHz \text{ (Notes 4, 8)}$	-	54	-	dBc
	$f_{CLK} = 100MSPS, f_{OUT} = 20.2MHz \text{ (Notes 4, 8)}$	-	62	-	dBc
	$f_{CLK} = 100MSPS, f_{OUT} = 5.04MHz, T = +25^\circ C \text{ (Notes 4, 8)}$	68	74	-	dBc
	$f_{CLK} = 100MSPS, f_{OUT} = 5.04MHz, T = \text{Min to Max (Notes 4, 8)}$	66	-	-	dBc
	$f_{CLK} = 100MSPS, f_{OUT} = 2.51MHz \text{ (Notes 4, 8)}$	-	75	-	dBc
	$f_{CLK} = 50MSPS, f_{OUT} = 20.2MHz \text{ (Notes 4, 8)}$	-	64	-	dBc
	$f_{CLK} = 50MSPS, f_{OUT} = 5.02MHz, T = +25^\circ C \text{ (Notes 4, 8)}$	68	74	-	dBc
	$f_{CLK} = 50MSPS, f_{OUT} = 5.02MHz, T = \text{Min to Max (Notes 4, 8)}$	66	-	-	dBc
	$f_{CLK} = 50MSPS, f_{OUT} = 2.51MHz \text{ (Notes 4, 8)}$	-	76	-	dBc
	$f_{CLK} = 50MSPS, f_{OUT} = 1.00MHz \text{ (Notes 4, 8)}$	-	78	-	dBc
	$f_{CLK} = 25MSPS, f_{OUT} = 1.0MHz \text{ (Notes 4, 8)}$	-	78	-	dBc
+5V Power Supply Multitone Power Ratio	$f_{CLK} = 20MSPS, f_{OUT} = 2.0MHz \text{ to } 2.99MHz, 8 \text{ Tones at } 110kHz \text{ Spacing (Notes 4, 8)}$	-	76	-	dBc
	$f_{CLK} = 100MSPS, f_{OUT} = 10MHz \text{ to } 14.95MHz, 8 \text{ Tones at } 530kHz \text{ Spacing (Notes 4, 8)}$	-	76	-	dBc
+3V Power Supply Spurious Free Dynamic Range, SFDR Within a Window	$f_{CLK} = 100MSPS, f_{OUT} = 20.2MHz, 30MHz \text{ Span (Notes 4, 8)}$	-	73	-	dBc
	$f_{CLK} = 100MSPS, f_{OUT} = 5.04MHz, 8MHz \text{ Span (Notes 4, 8)}$	-	92	-	dBc
	$f_{CLK} = 50MSPS, f_{OUT} = 5.02MHz, 8MHz \text{ Span (Notes 4, 8)}$	-	92	-	dBc
+3V Power Supply Total Harmonic Distortion (THD) to Nyquist	$f_{CLK} = 100MSPS, f_{OUT} = 4.0MHz \text{ (Notes 4, 8)}$	-	-71	-	dBc
	$f_{CLK} = 50MSPS, f_{OUT} = 2.0MHz \text{ (Notes 4, 8)}$	-	-75	-	dBc
	$f_{CLK} = 25MSPS, f_{OUT} = 1.0MHz \text{ (Notes 4, 8)}$	-	-75	-	dBc

Electrical Specifications $V_{DD} = DV_{DD} = +5V$ (except where otherwise noted), $V_{REF} = \text{Internal } 1.2V$, $I_{OUTFS} = 20mA$,
 $T_A = -40^{\circ}C$ to $+85^{\circ}C$, $T_A = +25^{\circ}C$ for All Typical Values. **(Continued)**

PARAMETER	TEST CONDITIONS	MIN (Note10)	TYP	MAX (Note 10)	UNITS
+3V Power Supply Spurious Free Dynamic Range, SFDR to Nyquist ($f_{CLK}/2$)	$f_{CLK} = 130MSPS$, $f_{OUT} = 40.4MHz$ (Notes 4, 8)	-	47	-	dBc
	$f_{CLK} = 130MSPS$, $f_{OUT} = 10.1MHz$ (Notes 4, 8)	-	66	-	dBc
	$f_{CLK} = 130MSPS$, $f_{OUT} = 5.02MHz$ (Notes 4, 8)	-	73	-	dBc
	$f_{CLK} = 100MSPS$, $f_{OUT} = 40.4MHz$ (Notes 4, 8)	-	48	-	dBc
	$f_{CLK} = 100MSPS$, $f_{OUT} = 20.2MHz$ (Notes 4, 8)	-	58	-	dBc
	$f_{CLK} = 100MSPS$, $f_{OUT} = 5.04MHz$ (Notes 4, 8)	-	72	-	dBc
	$f_{CLK} = 100MSPS$, $f_{OUT} = 2.51MHz$ (Notes 4, 8)	-	76	-	dBc
	$f_{CLK} = 50MSPS$, $f_{OUT} = 20.2MHz$ (Notes 4, 8)	-	53	-	dBc
	$f_{CLK} = 50MSPS$, $f_{OUT} = 5.02MHz$, $T = +25^{\circ}C$ (Notes 4, 8)	68	73	-	dBc
	$f_{CLK} = 50MSPS$, $f_{OUT} = 5.02MHz$, $T = \text{Min to Max}$ (Notes 4, 8)	66	-	-	dBc
	$f_{CLK} = 50MSPS$, $f_{OUT} = 2.51MHz$ (Notes 4, 8)	-	76	-	dBc
	$f_{CLK} = 50MSPS$, $f_{OUT} = 1.00MHz$ (Notes 4, 8)	-	76	-	dBc
	$f_{CLK} = 25MSPS$, $f_{OUT} = 1.0MHz$ (Notes 4, 8)	-	76	-	dBc
+3V Power Supply Multitone Power Ratio	$f_{CLK} = 20MSPS$, $f_{OUT} = 2.0MHz$ to $2.99MHz$, 8 Tones at 110kHz Spacing (Notes 4, 8)	-	75	-	dBc
	$f_{CLK} = 100MSPS$, $f_{OUT} = 10MHz$ to $14.95MHz$, 8 Tones at 530kHz Spacing (Notes 4, 8)	-	75	-	dBc
VOLTAGE REFERENCE					
Internal Reference Voltage, V_{FSADJ}	Pin 18 Voltage with Internal Reference	1.13	1.2	1.28	V
Internal Reference Voltage Drift		-	± 60	-	ppm/ $^{\circ}C$
Internal Reference Output Current Sink/Source Capability		-	± 50	-	μA
Reference Input Impedance		-	1	-	$M\Omega$
Reference Input Multiplying Bandwidth	(Note 8)	-	1.4	-	MHz
DIGITAL INPUTS D11-D0, CLK					
Input Logic High Voltage with 5V Supply, V_{IH}	(Note 3)	3.5	5	-	V
Input Logic High Voltage with 3V Supply, V_{IH}	(Note 3)	2.1	3	-	V
Input Logic Low Voltage with 5V Supply, V_{IL}	(Note 3)	-	0	1.3	V
Input Logic Low Voltage with 3V Supply, V_{IL}	(Note 3)	-	0	0.9	V
Sleep Input Current, I_{IH}		-25	-	+25	μA
Input Logic Current, I_{IH}		-20	-	+20	μA
Input Logic Current, I_{IL}		-10	-	+10	μA
Digital Input Capacitance, C_{IN}		-	5	-	pF

Electrical Specifications $V_{DD} = DV_{DD} = +5V$ (except where otherwise noted), $V_{REF} = \text{Internal } 1.2V$, $I_{OUTFS} = 20mA$, $T_A = -40^{\circ}C$ to $+85^{\circ}C$, $T_A = +25^{\circ}C$ for All Typical Values. **(Continued)**

PARAMETER	TEST CONDITIONS	MIN (Note10)	TYP	MAX (Note 10)	UNITS
TIMING CHARACTERISTICS					
Data Set-up Time, t_{SU}	See Figure 4 (Note 3)	-	1.5	-	ns
Data Hold Time, t_{HLD}	See Figure 4 (Note 3)	-	1.2	-	ns
Propagation Delay Time, t_{PD}	See Figure 4	-	2.5	-	ns
CLK Pulse Width, t_{PW1} , t_{PW2}	See Figure 4 (Note 3)	4	-	-	ns
POWER SUPPLY CHARACTERISTICS					
AV_{DD} Power Supply	(Note 9)	2.7	5.0	5.5	V
DV_{DD} Power Supply	(Note 9)	2.7	5.0	5.5	V
Analog Supply Current (I_{AVDD})	5V or 3V, $I_{OUTFS} = 20mA$	-	23	-	mA
	5V or 3V, $I_{OUTFS} = 2mA$	-	5	-	mA
Digital Supply Current (I_{DVDD})	5V (Note 5)	-	7	-	mA
	5V (Note 6)	-	12	-	mA
	5V (Note 7)	-	13	-	mA
	3V (Note 5)	-	2.4	-	mA
	3V (Note 6)	-	6	-	mA
	3V (Note 7)	-	5	-	mA
Supply Current (I_{AVDD}) Sleep Mode	5V or 3V, $I_{OUTFS} = \text{Don't Care}$	-	2.7	-	mA
Power Dissipation	5V, $I_{OUTFS} = 20mA$ (Note 5)	-	150	-	mW
	5V, $I_{OUTFS} = 20mA$ (Note 6)	-	175	200	mW
	5V, $I_{OUTFS} = 20mA$ (Note7)	-	180	-	mW
	5V, $I_{OUTFS} = 2mA$ (Note 6)	-	80	-	mW
	3V, $I_{OUTFS} = 20mA$ (Note 5)	-	76	-	mW
	3V, $I_{OUTFS} = 20mA$ (Note 6)	-	87	-	mW
	3V, $I_{OUTFS} = 20mA$ (Note7)	-	84	-	mW
	3V, $I_{OUTFS} = 2mA$ (Note 6)	-	32	-	mW
Power Supply Rejection	Single Supply (Note 8)	-0.2	-	+0.2	% FSR/V

NOTES:

- Gain Error measured as the error in the ratio between the full scale output current and the current through R_{SET} (typically $625\mu A$). Ideally the ratio should be 32.
- Limits should be considered typical and are not production tested.
- Spectral measurements made with differential transformer coupled output and no external filtering.
- Measured with the clock at 50MSPS and the output frequency at 10MHz.
- Measured with the clock at 100MSPS and the output frequency at 40MHz.
- Measured with the clock at 130MSPS and the output frequency at 10MHz.
- See "Definition of Specifications" on page 8.
- It is recommended that the output current be reduced to 12mA or less to maintain optimum performance for operation below 3V. DV_{DD} and AV_{DD} do not have to be equal.
- Parts are 100% tested at $+25^{\circ}C$. Over-temperature limits established by characterization and are not production tested.

Definition of Specifications

Differential Linearity Error, DNL, is the measure of the step size output deviation from code to code. Ideally, the step size should be 1 LSB. A DNL specification of 1 LSB or less guarantees monotonicity.

Full Scale Gain Drift, is measured by setting the data inputs to be all logic high (all 1s) and measuring the output voltage through a known resistance as the temperature is varied from T_{MIN} to T_{MAX} . It is defined as the maximum *deviation* from the *value* measured at room temperature to the *value* measured at either T_{MIN} or T_{MAX} . The units are ppm of FSR (full scale range) per °C.

Full Scale Gain Error, is the error from an ideal ratio of 32 between the output current and the full scale adjust current (through R_{SET}).

Integral Linearity Error, INL, is the measure of the worst case point that deviates from a best fit straight line of data values along the transfer curve.

Internal Reference Voltage Drift, is defined as the maximum *deviation* from the *value* measured at room temperature to the *value* measured at either T_{MIN} or T_{MAX} . The units are ppm per °C.

Offset Drift, is measured by setting the data inputs to all logic low (all 0s) and measuring the output voltage through a known resistance as the temperature is varied from T_{MIN} to T_{MAX} . It is defined as the maximum *deviation* from the *value* measured at room temperature to the *value* measured at either T_{MIN} or T_{MAX} . The units are ppm of FSR (full scale range) per degree °C.

Offset Error, is measured by setting the data inputs to all logic low (all 0s) and measuring the output voltage through a known resistance. Offset error is defined as the maximum *deviation* of the output current from a value of 0mA.

Output Settling Time, is the time required for the output voltage to settle to within a specified error band measured from the beginning of the output transition. The measurement is done by switching quarter scale. Termination impedance was 25Ω due to the parallel resistance of the 50Ω loading on the output and the oscilloscope's 50Ω input. This also aids the ability to resolve the specified error band without overdriving the oscilloscope.

Output Voltage Compliance Range, is the voltage limit imposed on the output. The output impedance should be chosen such that the voltage developed does not violate the compliance range.

Power Supply Rejection, is measured using a single power supply. The supply's nominal +5V is varied ±10% and the change in the DAC full scale output is noted.

Reference Input Multiplying Bandwidth, is defined as the 3dB bandwidth of the voltage reference input. It is measured

by using a sinusoidal waveform as the external reference with the digital inputs set to all 1s. The frequency is increased until the amplitude of the output waveform is 0.707 (-3dB) of its original value.

Singlet Glitch Area, is the switching transient appearing on the output during a code transition. It is measured as the area under the overshoot portion of the curve and is expressed as a volt-time specification. This is tested using a single code transition across a major current source.

Spurious Free Dynamic Range, SFDR, is the amplitude difference from the fundamental signal to the largest harmonically or non-harmonically related spur within the specified frequency window.

Total Harmonic Distortion, THD, is the ratio of the RMS value of the fundamental output signal to the RMS sum of the first five harmonic components.

Detailed Description

The HI5860 is a 12-bit, current out, CMOS, digital to analog converter. Its maximum update rate is 130MSPS and can be powered by either single or dual power supplies in the recommended range of +3V to +5V. Operation with clock rates higher than 130MSPS is possible; please contact the factory for more information. It consumes less than 180mW of power when using a +5V supply with the data switching at 130MSPS. The architecture is based on a segmented current source arrangement that reduces glitch by reducing the amount of current switching at any one time. In previous architectures that contained all binary weighted current sources or a binary weighted resistor ladder, the converter might have a substantially larger amount of current turning on and off at certain, worst-case transition points such as midscale and quarter scale transitions. By greatly reducing the amount of current switching at certain "major" transitions, the overall glitch of the converter is dramatically reduced, improving settling time, transient problems, and accuracy.

Digital Inputs and Termination

The HI5860 digital inputs are guaranteed to CMOS levels. However, TTL compatibility can be achieved by lowering the supply voltage to 3V due to the digital threshold of the input buffer being approximately half of the supply voltage. The internal register is updated on the rising edge of the clock. To minimize reflections, proper termination should be implemented. If the lines driving the clock and the digital inputs are long 50Ω lines, then 50Ω termination resistors should be placed as close to the converter inputs as possible connected to the digital ground plane (if separate grounds are used). These termination resistors are not likely needed as long as the digital waveform source is within a few inches of the DAC.

Ground Planes

Separate digital and analog ground planes should be used. All of the digital functions of the device and their

corresponding components should be located over the digital ground plane and terminated to the digital ground plane. The same is true for the analog components and the analog ground plane. Consult Application Note 9853.

Noise Reduction

To minimize power supply noise, 0.1µF capacitors should be placed as close as possible to the converter’s power supply pins, AV_{DD} and DV_{DD}. Also, the layout should be designed using separate digital and analog ground planes and these capacitors should be terminated to the digital ground for DV_{DD} and to the analog ground for AV_{DD}. Additional filtering of the power supplies on the board is recommended.

Voltage Reference

The internal voltage reference of the device has a nominal value of +1.2V with a ±60ppm/°C drift coefficient over the full temperature range of the converter. It is recommended that a 0.1µF capacitor be placed as close as possible to the REFIO pin, connected to the analog ground. The REFLO pin (16) selects the reference. The internal reference can be selected if pin 16 is tied low (ground). If an external reference is desired, then pin 16 should be tied high (the analog supply voltage) and the external reference driven into REFIO, pin 17. The full scale output current of the converter is a function of the voltage reference used and the value of R_{SET}. I_{OUT} should be within the 2mA to 20mA range, though operation below 2mA is possible, with performance degradation.

If the internal reference is used, V_{FSADJ} will equal approximately 1.2V (pin 18). If an external reference is used, V_{FSADJ} will equal the external reference. The calculation for I_{OUT} (Full Scale) is shown in Equation 1:

$$I_{OUT(FullScale)} = \frac{V_{FSADJ}}{R_{SET}} \times 32 \quad (EQ. 1)$$

If the full scale output current is set to 20mA by using the internal voltage reference (1.2V) and a 1.91kΩ R_{SET} resistor, then the input coding to output current will resemble Table 1:

TABLE 1. INPUT CODING vs OUTPUT CURRENT

INPUT CODE (D11-D0)	I _{OUTA} (mA)	I _{OUTB} (mA)
11 11111 11111	20	0
10 00000 00000	10	10
00 00000 00000	0	20

Outputs

I_{OUTA} and I_{OUTB} are complementary current outputs. The sum of the two currents is always equal to the full scale output current minus one LSB. If single-ended use is desired, a load resistor can be used to convert the output current to a voltage. It is recommended that the unused output be either grounded or equally terminated. The voltage developed at the output must not violate the output voltage compliance range of -0.3V to 1.25V. R_{LOAD} (the impedance loading each current output) should be chosen so that the desired output voltage is produced in conjunction with the output full scale current. If a known line impedance is to be driven, then the output load resistor should be chosen to match this impedance. The output voltage is shown in Equation 2:

$$V_{OUT} = I_{OUT} \times R_{LOAD} \quad (EQ. 2)$$

These outputs can be used in a differential-to-single-ended arrangement to achieve better harmonic rejection. The SFDR measurements in this data sheet were performed with a 1:1 transformer on the output of the DAC (see Figure 1). With the center tap grounded, the output swing of pins 21 and 22 will be biased at 0V. The loading as shown in Figure 1 will result in a 500mV signal at the output of the transformer if the full scale output current of the DAC is set to 20mA.

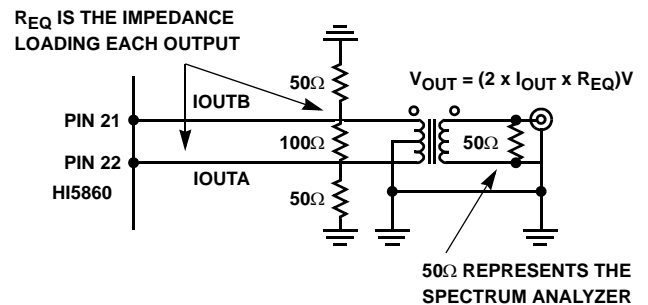

FIGURE 1.

V_{OUT} = 2 x I_{OUT} x R_{EQ} where R_{EQ} is ~12.5Ω. Allowing the center tap to float will result in identical transformer output, however the output pins of the DAC will have positive DC offset. Since the DAC’s output voltage compliance range is -0.3V to +1.25V, the center tap may need to be left floating or DC offset in order to increase the amount of signal swing available. The 50Ω load on the output of the transformer represents the spectrum analyzer’s input impedance.

Timing Diagrams

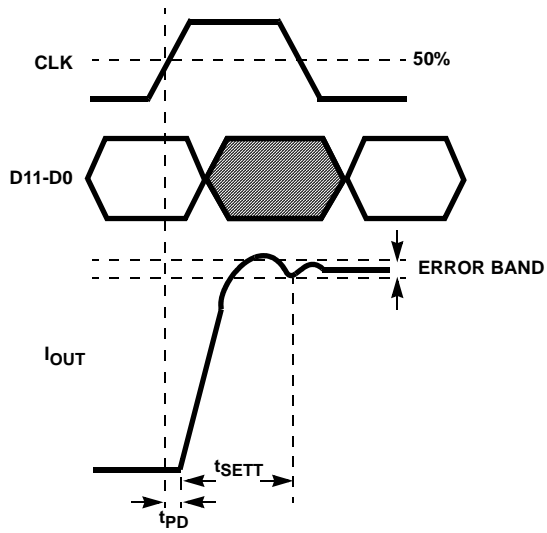

FIGURE 2. OUTPUT SETTLING TIME DIAGRAM

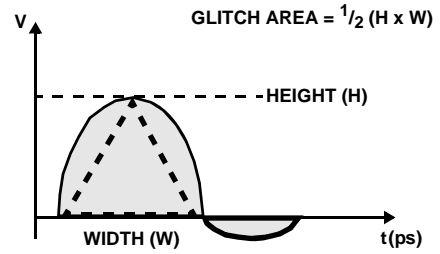

FIGURE 3. PEAK GLITCH AREA (SINGLET) MEASUREMENT METHOD

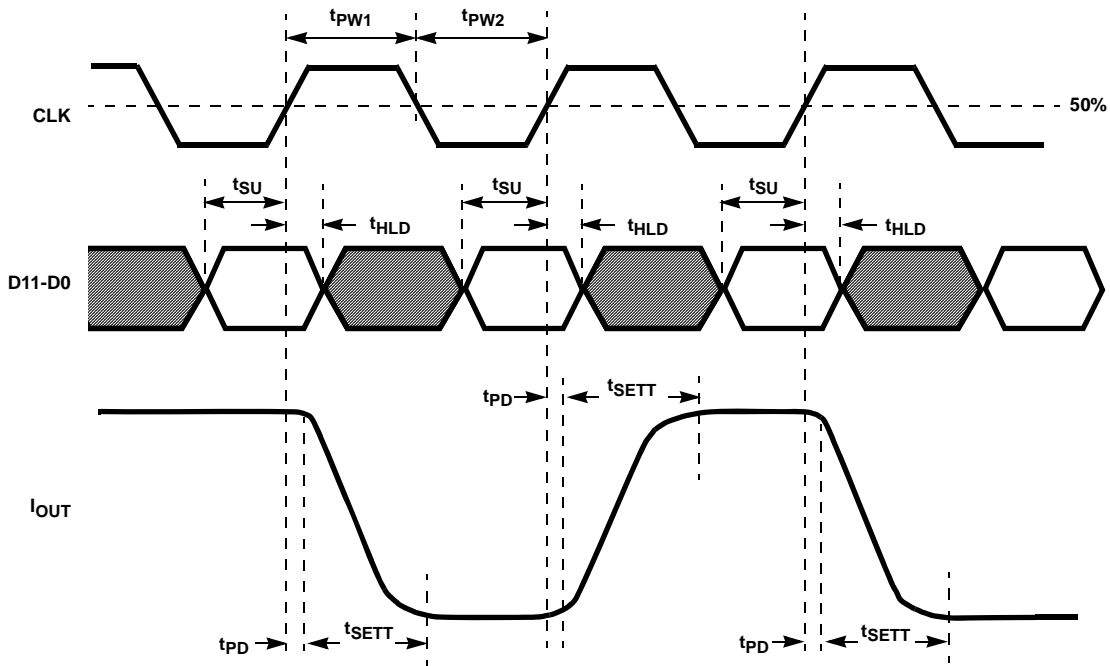
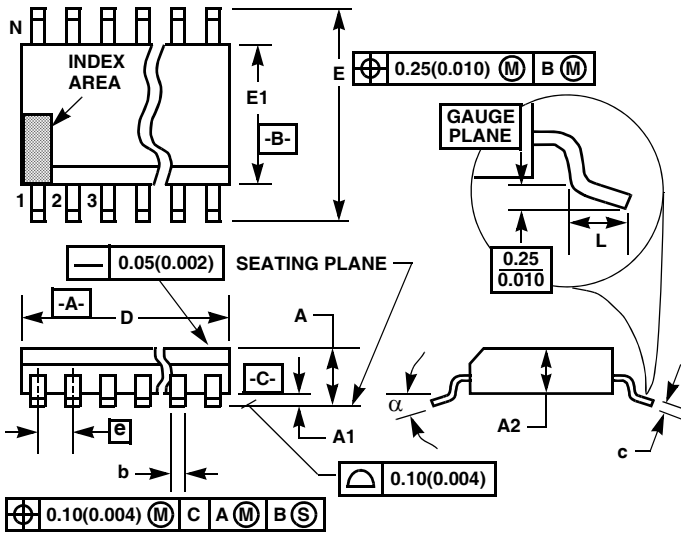

FIGURE 4. PROPAGATION DELAY, SETUP TIME, HOLD TIME AND MINIMUM PULSE WIDTH DIAGRAM

Thin Shrink Small Outline Plastic Packages (TSSOP)



M28.173
28 LEAD THIN SHRINK SMALL OUTLINE PLASTIC PACKAGE

SYMBOL	INCHES		MILLIMETERS		NOTES
	MIN	MAX	MIN	MAX	
A	-	0.047	-	1.20	-
A1	0.002	0.006	0.05	0.15	-
A2	0.031	0.051	0.80	1.05	-
b	0.0075	0.0118	0.19	0.30	9
c	0.0035	0.0079	0.09	0.20	-
D	0.378	0.386	9.60	9.80	3
E1	0.169	0.177	4.30	4.50	4
e	0.026 BSC		0.65 BSC		-
E	0.246	0.256	6.25	6.50	-
L	0.0177	0.0295	0.45	0.75	6
N	28		28		7
α	0°	8°	0°	8°	-

NOTES:

1. These package dimensions are within allowable dimensions of JEDEC MO-153-AE, Issue E.
2. Dimensioning and tolerancing per ANSI Y14.5M-1982.
3. Dimension "D" does not include mold flash, protrusions or gate burrs. Mold flash, protrusion and gate burrs shall not exceed 0.15mm (0.006 inch) per side.
4. Dimension "E1" does not include interlead flash or protrusions. Interlead flash and protrusions shall not exceed 0.15mm (0.006 inch) per side.
5. The chamfer on the body is optional. If it is not present, a visual index feature must be located within the crosshatched area.
6. "L" is the length of terminal for soldering to a substrate.
7. "N" is the number of terminal positions.
8. Terminal numbers are shown for reference only.
9. Dimension "b" does not include dambar protrusion. Allowable dambar protrusion shall be 0.08mm (0.003 inch) total in excess of "b" dimension at maximum material condition. Minimum space between protrusion and adjacent lead is 0.07mm (0.0027 inch).
10. Controlling dimension: MILLIMETER. Converted inch dimensions are not necessarily exact. (Angles in degrees)

Rev. 0 6/98

Small Outline Plastic Packages (SOIC)

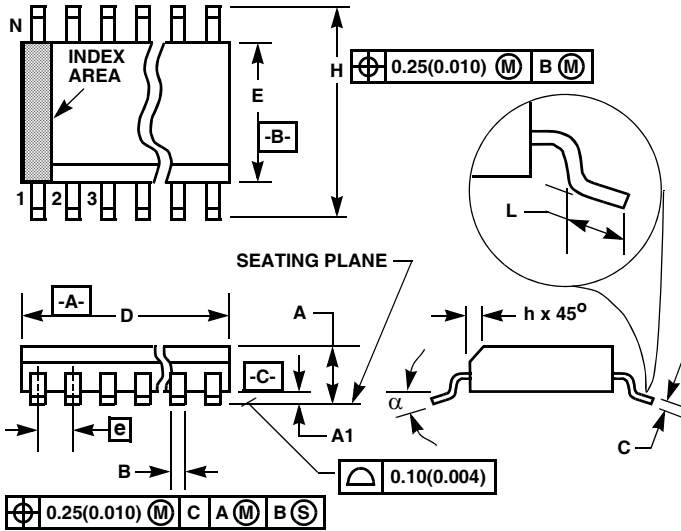

**M28.3 (JEDEC MS-013-AE ISSUE C)
28 LEAD WIDE BODY SMALL OUTLINE PLASTIC PACKAGE**

SYMBOL	INCHES		MILLIMETERS		NOTES
	MIN	MAX	MIN	MAX	
A	0.0926	0.1043	2.35	2.65	-
A1	0.0040	0.0118	0.10	0.30	-
B	0.013	0.0200	0.33	0.51	9
C	0.0091	0.0125	0.23	0.32	-
D	0.6969	0.7125	17.70	18.10	3
E	0.2914	0.2992	7.40	7.60	4
e	0.05 BSC		1.27 BSC		-
H	0.394	0.419	10.00	10.65	-
h	0.01	0.029	0.25	0.75	5
L	0.016	0.050	0.40	1.27	6
N	28		28		7
alpha	0°	8°	0°	8°	-

NOTES:

1. Symbols are defined in the "MO Series Symbol List" in Section 2.2 of Publication Number 95.
2. Dimensioning and tolerancing per ANSI Y14.5M-1982.
3. Dimension "D" does not include mold flash, protrusions or gate burrs. Mold flash, protrusion and gate burrs shall not exceed 0.15mm (0.006 inch) per side.
4. Dimension "E" does not include interlead flash or protrusions. Interlead flash and protrusions shall not exceed 0.25mm (0.010 inch) per side.
5. The chamfer on the body is optional. If it is not present, a visual index feature must be located within the crosshatched area.
6. "L" is the length of terminal for soldering to a substrate.
7. "N" is the number of terminal positions.
8. Terminal numbers are shown for reference only.
9. The lead width "B", as measured 0.36mm (0.014 inch) or greater above the seating plane, shall not exceed a maximum value of 0.61mm (0.024 inch)
10. Controlling dimension: MILLIMETER. Converted inch dimensions are not necessarily exact.

Rev. 0 12/93

All Intersil U.S. products are manufactured, assembled and tested utilizing ISO9000 quality systems. Intersil Corporation's quality certifications can be viewed at www.intersil.com/design/quality

Intersil products are sold by description only. Intersil Corporation reserves the right to make changes in circuit design, software and/or specifications at any time without notice. Accordingly, the reader is cautioned to verify that data sheets are current before placing orders. Information furnished by Intersil is believed to be accurate and reliable. However, no responsibility is assumed by Intersil or its subsidiaries for its use; nor for any infringements of patents or other rights of third parties which may result from its use. No license is granted by implication or otherwise under any patent or patent rights of Intersil or its subsidiaries.

For information regarding Intersil Corporation and its products, see www.intersil.com