

MAXIM

CMOS 8 Bit Multiplying D/A Converter

MX7523

General Description

The MX7523 is high performance multiplying 8 bit digital-to-analog converter (DAC). Low power CMOS technology and low cost make it suitable for a wide range of analog data acquisition and control applications.

Thin-film resistors assure 8 bit resolution with up to 10 bit linearity (L grade) over the full operating temperature range. In addition, all digital inputs are compatible with CMOS logic levels.

Maxim's MX7523 is electrically and pin compatible with the Analog Devices AD7523 and is available in a standard width 16-lead DIP as well as small outline package.

Applications

- Automatic Test Equipment
- Digital Calibration Systems
- Battery Powered Instruments
- Audio Gain Control
- Digitally Controlled Filters
- Programmable Power Supplies
- Motion Control Systems

Features

- ◆ 8, 9 and 10 Bit Linearity
- ◆ ±1.5% Untrimmed Gain Accuracy
- ◆ Guaranteed Monotonic
- ◆ Low Feedthrough 1/2LSB at 200kHz
- ◆ Low Power Consumption
- ◆ CMOS Compatible Logic Inputs
- ◆ Widely Second Sourced

Ordering Information

PART	TEMP RANGE	PACKAGE*	ERROR
MX7523JN	0°C to +70°C	Plastic DIP	½LSB
MX7523KN	0°C to +70°C	Plastic DIP	¼LSB
MX7523LN	0°C to +70°C	Plastic DIP	½LSB
MX7523JCWE	0°C to +70°C	Small Outline	½LSB
MX7523KCWE	0°C to +70°C	Small Outline	¼LSB
MX7523LCWE	0°C to +70°C	Small Outline	½LSB

* All devices — 16 lead packages

Pin Configuration

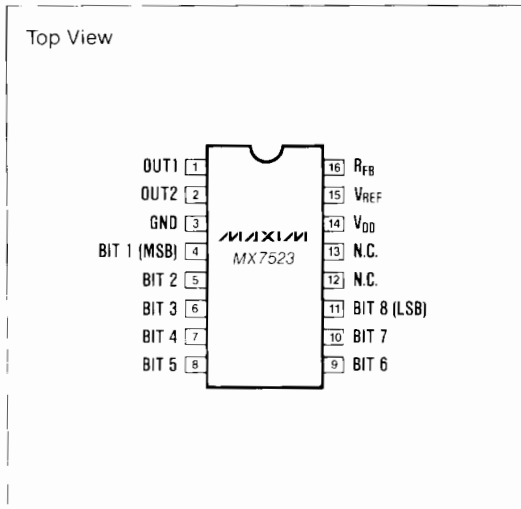

Typical Operating Circuit

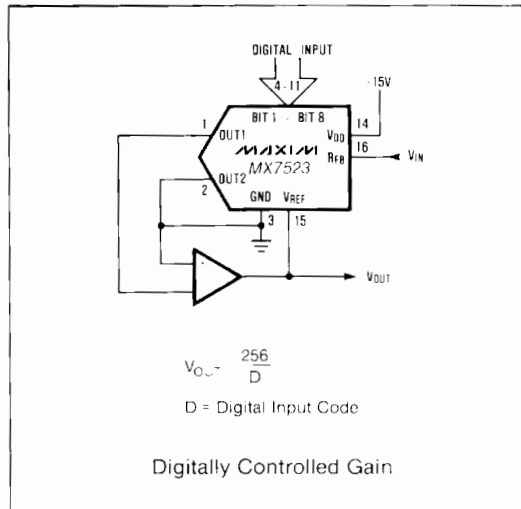

MAXIM

Maxim Integrated Products 1

Call toll free 1-800-998-8800 for free samples or literature.

CMOS 8 Bit Multiplying D/A Converter

ABSOLUTE MAXIMUM RATINGS

V_{DD} to GND	-0.3V, +17V	Storage Temperature	-65°C to +150°C
V_{REF} to GND	±25V	Lead Temperature (Soldering 10 secs)	+300°C
R_{FB} to GND	±25V	Power Dissipation to +70°C	
Digital Input Voltage to GND	-0.3V, V_{DD}	Plastic DIP	670mW
Output Voltage (OUT1, OUT2) (Note 1)	-0.3V, V_{DD}	Small Outline	450mW
Operating Temperature	0°C to +70°C		

Stresses above those listed under "Absolute Maximum Ratings" may cause permanent damage to the device. These are stress ratings only and functional operation of the device at these or any other conditions above those indicated in the operational sections of the specifications is not implied. Exposure to absolute maximum rating conditions for extended periods may affect device reliability.

ELECTRICAL CHARACTERISTICS

($T_A = T_{MIN}$ to T_{MAX} , $V_{DD} = +15V$, $V_{REF} = +10V$, $V_{OUT1} = V_{OUT2} = GND$, unless otherwise specified)

PARAMETER	SYMBOL	CONDITIONS	MIN.	TYP.	MAX.	UNITS
DC ACCURACY						
Resolution			8			Bits
Nonlinearity (Note 2)		0.2% FSR = 1/8LSB 0.1% FSR = 1/16LSB 0.05% FSR = 1/32LSB	J K L		1.5 1.1 1.1	LSB
Monotonicity			Guaranteed			
Gain Error (Note 2, 3)		Digital Inputs = V_{INH}	$T_A = +25^\circ C$ T_{MIN} to T_{MAX}		1.5 1.8	% FSR
Power Supply Rejection (Note 2)	PSRR	$V_{DD} = +14V$ to +15V	$T_A = +25^\circ C$ T_{MIN} to T_{MAX}		0.02 0.03	%/ V_{DD}
Output Leakage Current		OUT1, Digital Inputs = V_{INL}	$T_A = +25^\circ C$ T_{MIN} to T_{MAX}		50 200	nA
		OUT2, Digital Inputs = V_{INH}	$T_A = 25^\circ C$ T_{MIN} to T_{MAX}		50 200	
V_{REF} Input Resistance	R_{REF}	$T_A = +25^\circ C$		5	10	k Ω
V_{REF} Resistance Tempco		(Note 4)			-500	ppm/ $^\circ C$
AC PERFORMANCE (Note 4)						
Output Current Settling Time to 0.2% of FSR		$R_L = 100\Omega$, Digital Inputs = V_{INH} to V_{INL} and V_{INL} to V_{INH}	$T_A = +25^\circ C$ T_{MIN} to T_{MAX}		150 200	ns
Feedthrough Error		Digital Inputs = V_{INL} , $V_{REF} = 20V_{P-P}$, 200 KHz	$T_A = +25^\circ C$ T_{MIN} to T_{MAX}		1.5 1	LSB
Output Capacitance	C_{OUT}	Digital Inputs = V_{INH}	OUT1 OUT2		100 30	pF
		Digital Inputs = V_{INL}	OUT1 OUT2		30 100	
DIGITAL INPUTS						
Logic HIGH Threshold	V_{INH}			+14.5		V
Logic LOW Threshold	V_{INL}				-0.5	V
Input Leakage Current		Digital inputs = 0V or +15V			1	μA
Input Capacitance, (Note 4)					4	pF
Input Coding		Unipolar Operation (Table 1) Bipolar Operation (Table 2)				Binary Offset Binary
POWER REQUIREMENTS						
Power Supply Range	V_{DD}	Accuracy not guaranteed over this range.		+5	+16	V
Power Supply Current	I_{DD}	Digital inputs = V_{INH} or V_{INL}			100	μA

Note 1: $V_{OUT1, 2}$ may exceed the Absolute Maximum voltage rating if the current is limited to 30mA or less.

Note 2: Using internal feedback resistor (R_{FB}). Full scale range (FSR) = $-(V_{REF} - 1LSB)$ in unipolar mode.

Note 3: Maximum gain change from +25°C to T_{MIN} or T_{MAX} is $\pm 0.3\%$ FSR.

Note 4: Guaranteed by design but not 100% tested.

CMOS 8 Bit Multiplying D/A Converter

MX7523

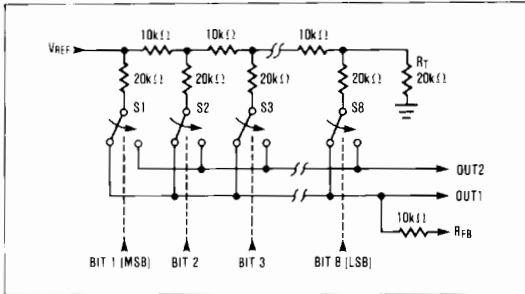

Figure 1. MX7523 Functional Diagram

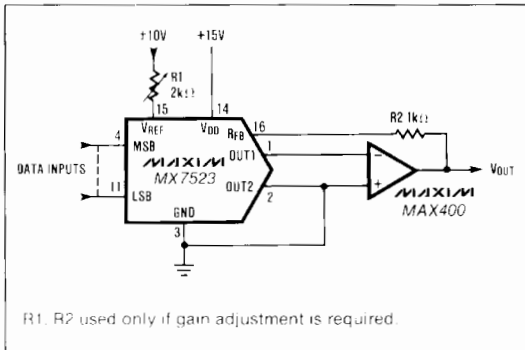

Figure 2. Unipolar Binary Operation (2-Quadrant Multiplication)

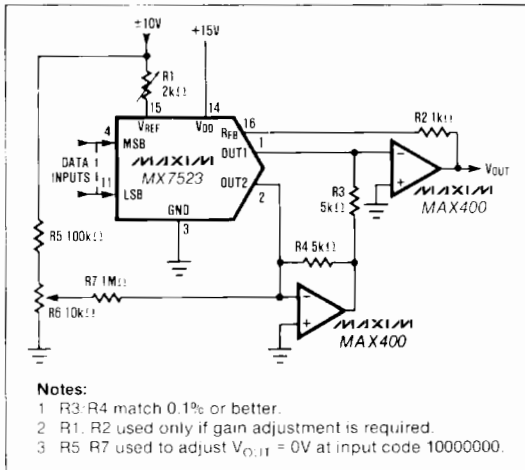

Figure 3. Bipolar (4-Quadrant) Operation

Table 1. Unipolar Binary Code Table

DIGITAL INPUT		ANALOG OUTPUT
MSB	LSB	
1	1 1 1 1 1 1 1 1	$-V_{REF} \left(\frac{225}{256} \right)$
1	0 0 0 0 0 0 0 1	$-V_{REF} \left(\frac{129}{256} \right)$
1	0 0 0 0 0 0 0 0	$-V_{REF} \left(\frac{128}{256} \right) = -\frac{V_{REF}}{2}$
0	1 1 1 1 1 1 1 1	$-V_{REF} \left(\frac{127}{256} \right)$
0	0 0 0 0 0 0 0 1	$-V_{REF} \left(\frac{1}{256} \right)$
0	0 0 0 0 0 0 0 0	$-V_{REF} \left(\frac{0}{256} \right) = 0$

Note: $1\text{LSB} = (2^{-8})(V_{REF}) = \left(\frac{1}{256} \right) (V_{REF})$

Table 2. Bipolar (Offset Binary) Code Table

DIGITAL INPUT		ANALOG OUTPUT
MSB	LSB	
1	1 1 1 1 1 1 1 1	$-V_{REF} \left(\frac{127}{128} \right)$
1	0 0 0 0 0 0 0 1	$-V_{REF} \left(\frac{1}{128} \right)$
1	0 0 0 0 0 0 0 0	0
0	1 1 1 1 1 1 1 1	$+V_{REF} \left(\frac{1}{128} \right)$
0	0 0 0 0 0 0 0 1	$+V_{REF} \left(\frac{127}{128} \right)$
0	0 0 0 0 0 0 0 0	$+V_{REF} \left(\frac{128}{128} \right)$

Note: $1\text{LSB} = (2^{-7})(V_{REF}) = \left(\frac{1}{128} \right) (V_{REF})$

Chip Topography

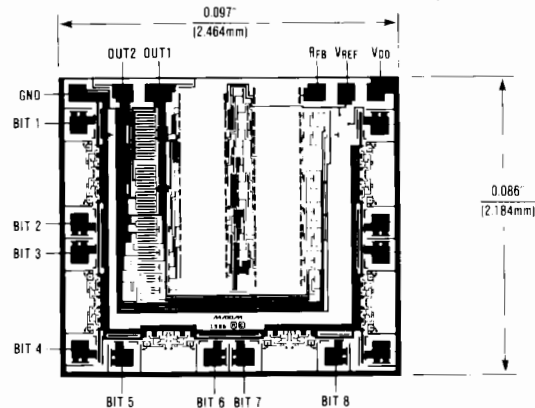

MX7523

CMOS 8 Bit Multiplying D/A Converter

Package Information

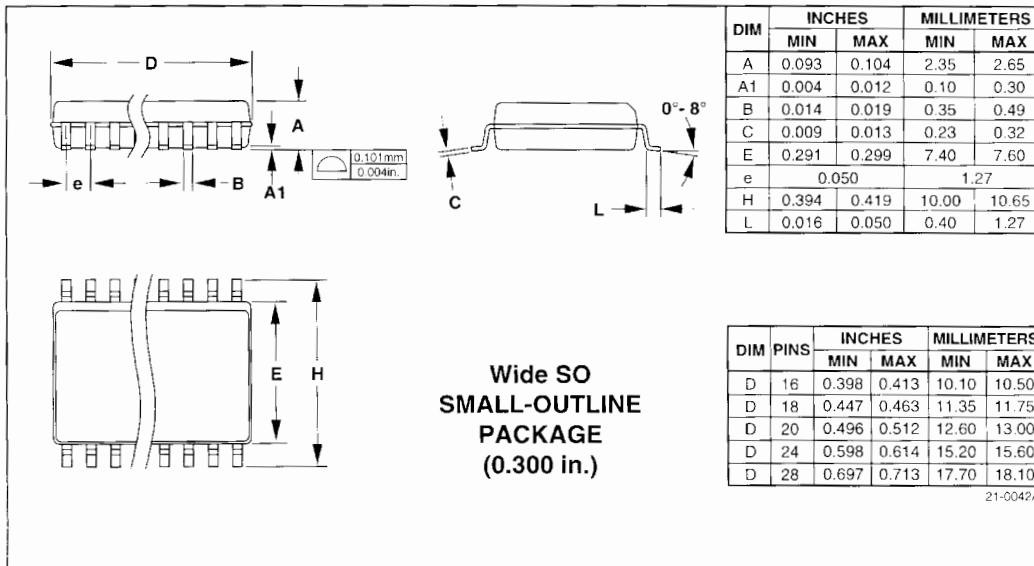
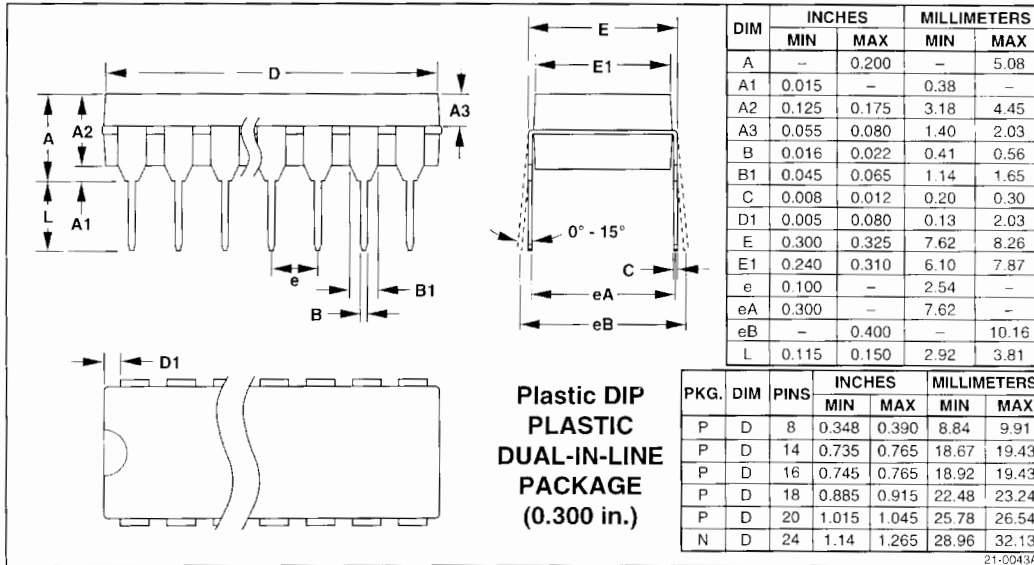

Maxim cannot assume responsibility for use of any circuitry other than circuitry entirely embodied in a Maxim product. No circuit patent licenses are implied. Maxim reserves the right to change the circuitry and specifications without notice at any time.

4 Maxim Integrated Products, 120 San Gabriel Drive, Sunnyvale, CA 94086 (408) 737-7600

© 1995 Maxim Integrated Products

Printed USA

MAXIM is a registered trademark of Maxim Integrated Products.