

2.5V or 3.3V, 200-MHz, 12-Output Zero Delay Buffer

Features

- 6 ps typical period jitter
- Output frequency range: 8.33 MHz to 200 MHz
- Input frequency range: 6.25 MHz to 125 MHz
- 2.5V or 3.3V operation
- Split 2.5V/3.3V outputs
- 12 Clock outputs: drive up to 24 clock lines
- One feedback output
- Three reference clock inputs: LVPECL or LVCMOS
- Phase-locked loop (PLL) bypass mode
- Spread Aware™
- Output enable/disable
- Pin-compatible with MPC9773 and MPC973
- Industrial temperature range: -40°C to +85°C
- 52-pin 1.0-mm TQFP package

Description

The CY29773 is a low-voltage high-performance 200-MHz PLL-based zero delay buffer designed for high-speed clock distribution applications.

The CY29773 features one LVPECL and two LVCMOS reference clock inputs and provides 12 outputs partitioned in three banks of four outputs each. Each bank divides the VCO output per SEL(A:C) settings (see *Table 2. Function Table (Configuration Controls)*). These dividers allow output-to-input ratios of 8:1, 6:1, 5:1, 4:1, 3:1, 8:3, 5:2, 2:1, 5:3, 3:2, 4:3, 5:4, 1:1, and 5:6. Each LVCMOS-compatible output can drive 50Ω series- or parallel-terminated transmission lines. For series-terminated transmission lines, each output can drive one or two traces, giving the device an effective fanout of 1:24.

The PLL is ensured stable, given that the VCO is configured to run between 200 MHz to 500 MHz. This allows a wide range of output frequencies, from 8 MHz to 200 MHz. For normal operation, the external feedback input FB_IN is connected to the feedback output FB_OUT. The internal VCO is running at multiples of the input reference clock set by the feedback divider (see *Table 1. Frequency Table*).

When PLL_EN is LOW, PLL is bypassed and the reference clock directly feeds the output dividers. This mode is fully static and the minimum input clock frequency specification does not apply.

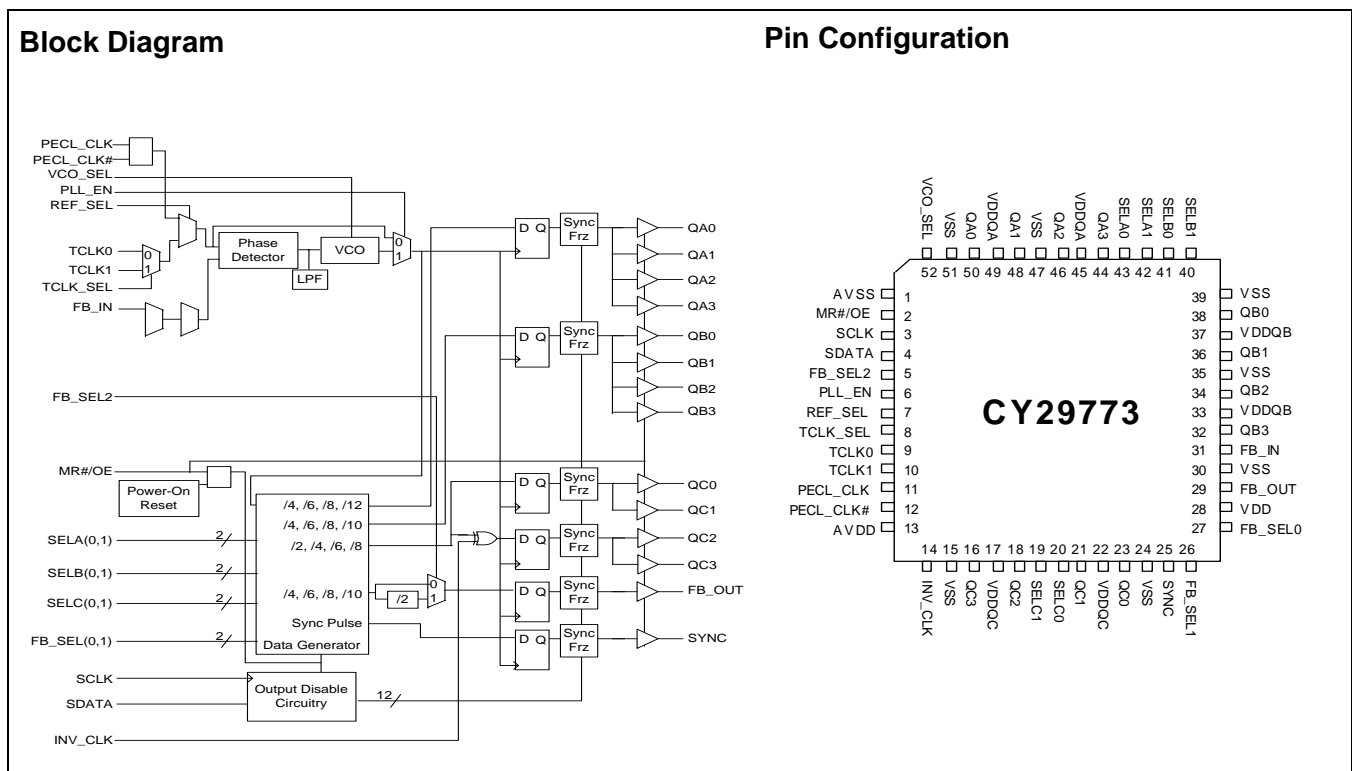

Pin Description ^[1]

Pin	Name	I/O	Type	Description
11	PECL_CLK	I, PU	LVPECL	LVPECL reference clock input.
12	PECL_CLK#	I	LVPECL	LVPECL reference clock input.
9	TCLK0	I, PU	LVC MOS	LVC MOS/LVTTL reference clock input.
10	TCLK1	I, PU	LVC MOS	LVC MOS/LVTTL reference clock input.
44,46,48,50	QA(3:0)	O	LVC MOS	Clock output bank A.
32,34,36,38	QB(3:0)	O	LVC MOS	Clock output bank B.
16,18,21,23	QC(3:0)	O	LVC MOS	Clock output bank C.
29	FB_OUT	O	LVC MOS	Feedback clock output. Connect to FB_IN for normal operation.
31	FB_IN	I, PU	LVC MOS	Feedback clock input. Connect to FB_OUT for normal operation. This input should be at the same voltage rail as input reference clock. See <i>Table 1. Frequency Table.</i>
25	SYNC	O	LVC MOS	Synchronous pulse output. This output is used for system synchronization.
6	PLL_EN	I, PU	LVC MOS	PLL enable/bypass input. When Low, PLL is disabled/bypassed and the input clock connects to the output dividers.
2	MR#/OE	I, PU	LVC MOS	Master reset and Output enable/disable input. See <i>Table 2. Function Table (Configuration Controls).</i>
8	TCLK_SEL	I, PU	LVC MOS	LVC MOS Clock reference select input. See <i>Table 2. Function Table (Configuration Controls).</i>
7	REF_SEL	I, PU	LVC MOS	LVC MOS/LVPECL Reference select input. See <i>Table 2. Function Table (Configuration Controls).</i>
52	VCO_SEL	I, PU	LVC MOS	VCO Operating frequency select input. See <i>Table 2. Function Table (Configuration Controls).</i>
14	INV_CLK	I, PU	LVC MOS	QC(2,3) Phase selection input. See <i>Table 2. Function Table (Configuration Controls).</i>
5,26,27	FB_SEL(2:0)	I, PU	LVC MOS	Feedback divider select input. See <i>Table 6.</i>
42,43	SELA(1,0)	I, PU	LVC MOS	Frequency select input, Bank A. See <i>Table 3. Function Table (Bank A).</i>
40,41	SELB(1,0)	I, PU	LVC MOS	Frequency select input, Bank B. See <i>Table 4. Function Table (Bank B).</i>
19,20	SELC(1,0)	I, PU	LVC MOS	Frequency select input, Bank C. See <i>Table 5. Function Table (Bank C).</i>
3	SCLK	I, PU	LVC MOS	Serial clock input.
4	SDATA	I, PU	LVC MOS	Serial data input.
45,49	VDDQA	Supply	VDD	2.5V or 3.3V Power supply for bank A output clocks. ^[2,3]
33,37	VDDQB	Supply	VDD	2.5V or 3.3V Power supply for bank B output clocks. ^[2,3]
22,17	VDDQC	Supply	VDD	2.5V or 3.3V Power supply for bank C output clocks. ^[2,3]
13	AVDD	Supply	VDD	2.5V or 3.3V Power supply for PLL. ^[2,3]
28	VDD	Supply	VDD	2.5V or 3.3V Power supply for core and inputs. ^[2,3]
1	AVSS	Supply	Ground	Analog Ground.
15,24,30,35,39,47,51	VSS	Supply	Ground	Common Ground.

Notes:

1. PU = Internal pull-up, PD = Internal pull-down.
2. A 0.1- μ F bypass capacitor should be placed as close as possible to each positive power pin (<0.2"). If these bypass capacitors are not close to the pins their high frequency filtering characteristics will be cancelled by the lead inductance of the traces.
3. AVDD and VDD pins must be connected to a power supply level that is at least equal or higher than that of VDDQA, VDDQB, and VDDQC power supply pins.

Table 1. Frequency Table

Feedback Output Divider	VCO	Input Frequency Range (AVDD = 3.3V)	Input Frequency Range (AVDD = 2.5V)
÷4	Input Clock * 4	50 MHz to 125 MHz	50 MHz to 95 MHz
÷6	Input Clock * 6	33.3 MHz to 83.3 MHz	33.3 MHz to 63.3 MHz
÷8	Input Clock * 8	25 MHz to 62.5 MHz	25 MHz to 47.5 MHz
÷10	Input Clock * 10	20 MHz to 50 MHz	20 MHz to 38 MHz
÷12	Input Clock * 12	16.6 MHz to 41.6 MHz	16.6 MHz to 31.6 MHz
÷16	Input Clock * 16	12.5 MHz to 31.25 MHz	12.5 MHz to 23.75 MHz
÷20	Input Clock * 20	10 MHz to 25 MHz	10 MHz to 19 MHz
÷24	Input Clock * 24	8.3 MHz to 20.8 MHz	8.3 MHz to 15.8 MHz
÷32	Input Clock * 32	6.25 MHz to 15.625 MHz	6.25 MHz to 11.8 MHz
÷40	Input Clock * 40	5 MHz to 12.5 MHz	5 MHz to 9.5 MHz

Table 2. Function Table (Configuration Controls)

Control	Default	0	1
REF_SEL	1	TCLK0, TCLK1	PECL_CLK
TCLK_SEL	1	TCLK0	TCLK1
VCO_SEL	1	VCO÷2 (low input frequency range)	VCO÷1 (high input frequency range)
PLL_EN	1	Bypass mode, PLL disabled. The input clock connects to the output dividers	PLL enabled. The VCO output connects to the output dividers
INV_CLK	1	QC2 and QC3 are in phase with QC0 and QC1	QC2 and QC3 are inverted (180° phase shift) with respect to QC0 and QC1
MR#/OE	1	Outputs disabled (three-state) and reset of the device. During reset/output disable the PLL feedback loop is open and the VCO running at its minimum frequency. The device is reset by the internal power-on reset (POR) circuitry during power-up.	Outputs enabled

Table 3. Function Table (Bank A)

VCO_SEL	SELA1	SELA0	QA(0:3)
0	0	0	÷8
0	0	1	÷12
0	1	0	÷16
0	1	1	÷24
1	0	0	÷4
1	0	1	÷6
1	1	0	÷8
1	1	1	÷12

Table 5. Function Table (Bank C)

VCO_SEL	SELC1	SELC0	QC(0:3)
0	0	0	÷4
0	0	1	÷8
0	1	0	÷12
0	1	1	÷16
1	0	0	÷2
1	0	1	÷4
1	1	0	÷6
1	1	1	÷8

Table 4. Function Table (Bank B)

VCO_SEL	SELB1	SELB0	QB(0:3)
0	0	0	÷8
0	0	1	÷12
0	1	0	÷16
0	1	1	÷20
1	0	0	÷4
1	0	1	÷6
1	1	0	÷8
1	1	1	÷10

Table 6. Function Table (FB_OUT)

VCO_SEL	FB_SEL2	FB_SEL1	FB_SEL0	FB_OUT
0	0	0	0	÷8
0	0	0	1	÷12
0	0	1	0	÷16
0	0	1	1	÷20
0	1	0	0	÷16
0	1	0	1	÷24
0	1	1	0	÷32
0	1	1	1	÷40
1	0	0	0	÷4
1	0	0	1	÷6
1	0	1	0	÷8
1	0	1	1	÷10
1	1	0	0	÷8
1	1	0	1	÷12
1	1	1	0	÷16
1	1	1	1	÷20

Absolute Maximum Conditions

Parameter	Description	Condition	Min.	Max.	Unit
V _{DD}	DC Supply Voltage		-0.3	5.5	V
V _{DD}	DC Operating Voltage	Functional	2.375	3.465	V
V _{IN}	DC Input Voltage	Relative to V _{SS}	-0.3	V _{DD} + 0.3	V
V _{OUT}	DC Output Voltage	Relative to V _{SS}	-0.3	V _{DD} + 0.3	V
V _{TT}	Output termination Voltage			V _{DD} ÷ 2	V
LU	Latch-up Immunity	Functional	200	-	mA
R _{PS}	Power Supply Ripple	Ripple Frequency < 100 kHz		150	mVp-p
T _S	Temperature, Storage	Non-functional	-65	+150	°C
T _A	Temperature, Operating Ambient	Functional	-40	+85	°C
T _J	Temperature, Junction	Functional		+150	°C
∅ _{JC}	Dissipation, Junction to Case	Functional		23	°C/W
∅ _{JA}	Dissipation, Junction to Ambient	Functional		55	°C/W
ESD _H	ESD Protection (Human Body Model)		2000		V
FIT	Failure in Time	Manufacturing test		10	ppm

DC Electrical Specifications (V_{DD} = 2.5V ±5%, T_A = -40°C to +85°C)

Parameter	Description	Condition	Min.	Typ.	Max.	Unit
V _{IL}	Input Voltage, Low	LVC MOS	-	-	0.7	V
V _{IH}	Input Voltage, High	LVC MOS	1.7	-	V _{DD} +0.3	V
V _{PP}	Peak-Peak Input Voltage	LVPECL	250	-	1000	mV
V _{CMR}	Common Mode Range ^[4]	LVPECL	1.0	-	V _{DD} - 0.6	V
V _{OL}	Output Voltage, Low ^[5]	I _{OL} = 15 mA	-	-	0.6	V
V _{OH}	Output Voltage, High ^[5]	I _{OH} = -15 mA	1.8	-	-	V
I _{IL}	Input Current, Low ^[5]	V _{IL} = V _{SS}	-	-	-100	μA
I _{IH}	Input Current, High ^[6]	V _{IL} = V _{DD}	-	-	100	μA
I _{DDA}	PLL Supply Current	AVDD only	-	5	10	mA
I _{DDQ}	Quiescent Supply Current	All VDD pins except AVDD	-	-	8	mA
I _{DD}	Dynamic Supply Current	Outputs loaded @ 100 MHz	-	135	-	mA
C _{IN}	Input Pin Capacitance		-	4	-	pF
Z _{OUT}	Output Impedance		14	18	22	Ω

DC Electrical Specifications (V_{DD} = 3.3V ± 5%, T_A = -40°C to +85°C)

Parameter	Description	Condition	Min.	Typ.	Max.	Unit
V _{IL}	Input Voltage, Low	LVC MOS	-	-	0.8	V
V _{IH}	Input Voltage, High	LVC MOS	2.0	-	V _{DD} +0.3	V
V _{PP}	Peak-Peak Input Voltage	LVPECL	250	-	1000	mV
V _{CMR}	Common Mode Range ^[4]	LVPECL	1.0	-	V _{DD} - 0.6	V
V _{OL}	Output Voltage, Low ^[5]	I _{OL} = 24 mA	-	-	0.55	V
		I _{OL} = 12 mA	-	-	0.30	
V _{OH}	Output Voltage, High ^[5]	I _{OH} = -24 mA	2.4	-	-	V
I _{IL}	Input Current, Low ^[6]	V _{IL} = V _{SS}	-	-	-100	μA

Notes:

- V_{CMR} (DC) is the crossing point of the differential input signal. Normal operation is obtained when the crossing point is within the V_{CMR} range and the input swing is within the V_{PP} (DC) specification.
- Driving one 50Ω parallel terminated transmission line to a termination voltage of V_{TT}. Alternatively, each output drives up to two 50Ω series terminated transmission lines.
- Inputs have pull-up or pull-down resistors that affect the input current.

DC Electrical Specifications ($V_{DD} = 3.3V \pm 5\%$, $T_A = -40^{\circ}C$ to $+85^{\circ}C$) (continued)

Parameter	Description	Condition	Min.	Typ.	Max.	Unit
I_{IH}	Input Current, High ^[6]	$V_{IL} = V_{DD}$	–	–	100	μA
I_{DDA}	PLL Supply Current	AVDD only	–	5	10	mA
I_{DDQ}	Quiescent Supply Current	All VDD pins except AVDD	–	–	8	mA
I_{DD}	Dynamic Supply Current	Outputs loaded @ 100 MHz	–	225	–	mA
C_{IN}	Input Pin Capacitance		–	4	–	pF
Z_{OUT}	Output Impedance		12	15	18	Ω

AC Electrical Specifications ($V_{DD} = 2.5V \pm 5\%$, $T_A = -40^{\circ}C$ to $+85^{\circ}C$)^[7]

Parameter	Description	Condition	Min.	Typ.	Max.	Unit
f_{VCO}	VCO Frequency		200	–	380	MHz
f_{in}	Input Frequency	$\div 4$ Feedback	50	–	95	MHz
		$\div 6$ Feedback	33.3	–	63.3	
		$\div 8$ Feedback	25	–	47.5	
		$\div 10$ Feedback	20	–	38	
		$\div 12$ Feedback	16.6	–	31.6	
		$\div 16$ Feedback	12.5	–	23.75	
		$\div 20$ Feedback	10	–	19	
		$\div 24$ Feedback	8.3	–	15.8	
		$\div 32$ Feedback	6.25	–	11.8	
		$\div 40$ Feedback	5	–	9.5	
	Bypass mode (PLL_EN = 0)	0	–	200		
f_{refDC}	Input Duty Cycle		25	–	75	%
V_{PP}	Peak-Peak Input Voltage	LVPECL	500	–	1000	mV
V_{CMR}	Common Mode Range ^[8]	LVPECL	1.2	–	$V_{DD} - 0.6$	V
t_r, t_f	TCLK Input Rise/Fall Time	0.7V to 1.7V	–	–	1.0	ns
f_{MAX}	Maximum Output Frequency	$\div 2$ Output	100	–	190	MHz
		$\div 4$ Output	50	–	95	
		$\div 6$ Output	33.3	–	63.3	
		$\div 8$ Output	25	–	47.5	
		$\div 10$ Output	20	–	38	
		$\div 12$ Output	16.6	–	31.6	
		$\div 16$ Output	12.5	–	23.75	
		$\div 20$ Output	10	–	19	
		$\div 24$ Output	8.3	–	15.8	
f_{SCLK}	Serial Clock Frequency		–	–	20	MHz
DC	Output Duty Cycle	$f_{MAX} < 100$ MHz	47.5	–	52.5	%
		$f_{MAX} > 100$ MHz	45	–	55	
t_r, t_f	Output Rise/Fall times	0.6V to 1.8V	0.1	–	1.0	ns
$t_{(\phi)}$	Propagation Delay (static phase offset)	TCLK to FB_IN	–125	–	125	ps
		PCLK to FB_IN	–125	–	125	

Notes:

- AC characteristics apply for parallel output termination of 50Ω to V_{TT} . Outputs are at same supply voltage unless otherwise stated. Parameters are guaranteed by characterization and are not 100% tested.
- V_{CMR} (AC) is the crosspoint of the differential input signal. Normal AC operation is obtained when the crosspoint is within the V_{CMR} range and the input swing lies within the V_{PP} (AC) specification. Violation of V_{CMR} or V_{PP} impacts static phase offset $t_{(\phi)}$.

AC Electrical Specifications ($V_{DD} = 2.5V \pm 5\%$, $T_A = -40^{\circ}C$ to $+85^{\circ}C$)^[7]

Parameter	Description	Condition	Min.	Typ.	Max.	Unit
$t_{sk(O)}$	Output-to-Output Skew	Skew within Bank A	–	–	75	ps
		Skew within Bank B	–	–	100	
		Skew within Bank C	–	–	150	
$t_{sk(B)}$	Bank-to-Bank Skew		–	–	400	ps
$t_{PLZ, HZ}$	Output Disable Time		–	–	10	ns
$t_{PZL, ZH}$	Output Enable Time		–	–	10	ns
BW	PLL Closed Loop Bandwidth (-3dB)	÷4 Feedback	–	1.3–2.0	–	MHz
		÷6 Feedback	–	0.7–1.3	–	
		÷8 Feedback	–	0.9–1.3	–	
		÷10 Feedback	–	0.6–1.1	–	
		÷12 Feedback	–	0.6–0.9	–	
		÷16 Feedback	–	0.4–0.6	–	
		÷20 Feedback	–	0.6–0.9	–	
$t_{JIT(CC)}$	Cycle-to-Cycle Jitter	Same frequency (125 MHz) RMS (1σ)	–	7	30	ps
		Same frequency	–	–	150	
		Multiple frequencies	–	–	435	
$t_{JIT(PER)}$	Period Jitter	Same frequency (125 MHz) RMS (1σ)	–	6	30	ps
		Same frequency	–	45	75	
		Multiple frequencies	–	–	235	
$t_{JIT(\phi)}$	I/O Phase Jitter		–	–	150	ps
t_{LOCK}	Maximum PLL Lock Time		–	–	1	ms

AC Electrical Specifications ($V_{DD} = 3.3V \pm 5\%$, $T_A = -40^{\circ}C$ to $+85^{\circ}C$)^[7]

Parameter	Description	Condition	Min.	Typ.	Max.	Unit
f_{VCO}	VCO Frequency		200	–	500	MHz
f_{in}	Input Frequency	÷4 Feedback	50	–	125	MHz
		÷6 Feedback	33.3	–	83.3	
		÷8 Feedback	25	–	62.5	
		÷10 Feedback	20	–	50	
		÷12 Feedback	16.6	–	41.6	
		÷16 Feedback	12.5	–	31.25	
		÷20 Feedback	10	–	25	
		÷24 Feedback	8.3	–	20.8	
		÷32 Feedback	6.25	–	15.625	
		÷40 Feedback	5	–	12.5	
		Bypass mode (PLL_EN = 0)	0	–	200	
f_{refDC}	Input Duty Cycle		25	–	75	%
V_{PP}	Peak-Peak Input Voltage	LVPECL	500	–	1000	mV
V_{CMR}	Common Mode Range ^[8]	LVPECL	1.2	–	$V_{DD}-0.9$	V
t_r, t_f	TCLK Input Rise/FallTime	0.8V to 2.0V	–	–	1.0	ns

AC Electrical Specifications ($V_{DD} = 3.3V \pm 5\%$, $T_A = -40^\circ C$ to $+85^\circ C$)^[7]

Parameter	Description	Condition	Min.	Typ.	Max.	Unit
f _{MAX}	Maximum Output Frequency	±2 Output	100	–	200	MHz
		±4 Output	50	–	125	
		±6 Output	33.3	–	83.3	
		±8 Output	25	–	62.5	
f _{MAX}	Maximum Output Frequency (continued)	±10 Output	20	–	50	MHz
		±12 Output	16.6	–	41.6	
		±16 Output	12.5	–	31.25	
		±20 Output	10	–	25	
		±24 Output	8.3	–	20.8	
f _{SCLK}	Serial Clock Frequency		–	–	20	MHz
DC	Output Duty Cycle	f _{MAX} < 100 MHz	48	–	52	%
		f _{MAX} > 100 MHz	45	–	55	
t _r , t _f	Output Rise/Fall times	0.55V to 2.4V	0.1	–	1.0	ns
t _(φ)	Propagation Delay (static phase offset)	TCLK to FB_IN, same VDD	–125	–	125	ps
		PCLK to FB_IN, same VDD	–125	–	125	
t _{sk(O)}	Output-to-Output Skew	Skew within Bank A	–	–	75	ps
		Skew within Bank B	–	–	100	
		Skew within Bank C	–	–	150	
tsk(B)	Bank-to-Bank Skew		–	–	325	ps
t _{PLZ, HZ}	Output Disable Time		–	–	8	ns
t _{PZL, ZH}	Output Enable Time		–	–	8	ns
BW	PLL Closed Loop Bandwidth (–3 dB)	±4 Feedback	–	1.3–2.0	–	MHz
		±6 Feedback	–	0.7–1.3	–	
		±8 Feedback	–	0.9–1.3	–	
		±10 Feedback	–	0.6–1.1	–	
		±12 Feedback	–	0.6–0.9	–	
		±16 Feedback	–	0.4–0.6	–	
		±20 Feedback	–	0.6–0.9	–	
t _{JIT(CC)}	Cycle-to-Cycle Jitter	Same frequency (125 MHz) RMS (1σ)	–	7	30	ps
		Same frequency	–	–	100	
		Multiple frequencies	–	–	375	
t _{JIT(PER)}	Period Jitter	Same frequency (125 MHz) RMS (1σ)	–	6	30	ps
		Same frequency	–	45	75	
		Multiple frequencies	–	–	225	
t _{JIT(φ)}	I/O Phase Jitter	I/O same V _{DD}	–	–	150	ps
t _{LOCK}	Maximum PLL Lock Time		–	–	1	ms

SYNC Output

In situations where output frequency relationships are not integer multiples of each other the SYNC output provides a signal for system synchronization. The CY29773 monitors the relationship between the QA and the QC output clocks. It provides a low going pulse, one period in duration, one period prior to the coincident rising edges of the QA and QC outputs.

The duration and the placement of the pulse depend on the higher of the QA and QC output frequencies. *Figure 1* illustrates various waveforms for the SYNC output. Note that the SYNC output is defined for all possible combinations of the QA and QC outputs even though under some relationships the lower frequency clock could be used as a synchronizing signal.

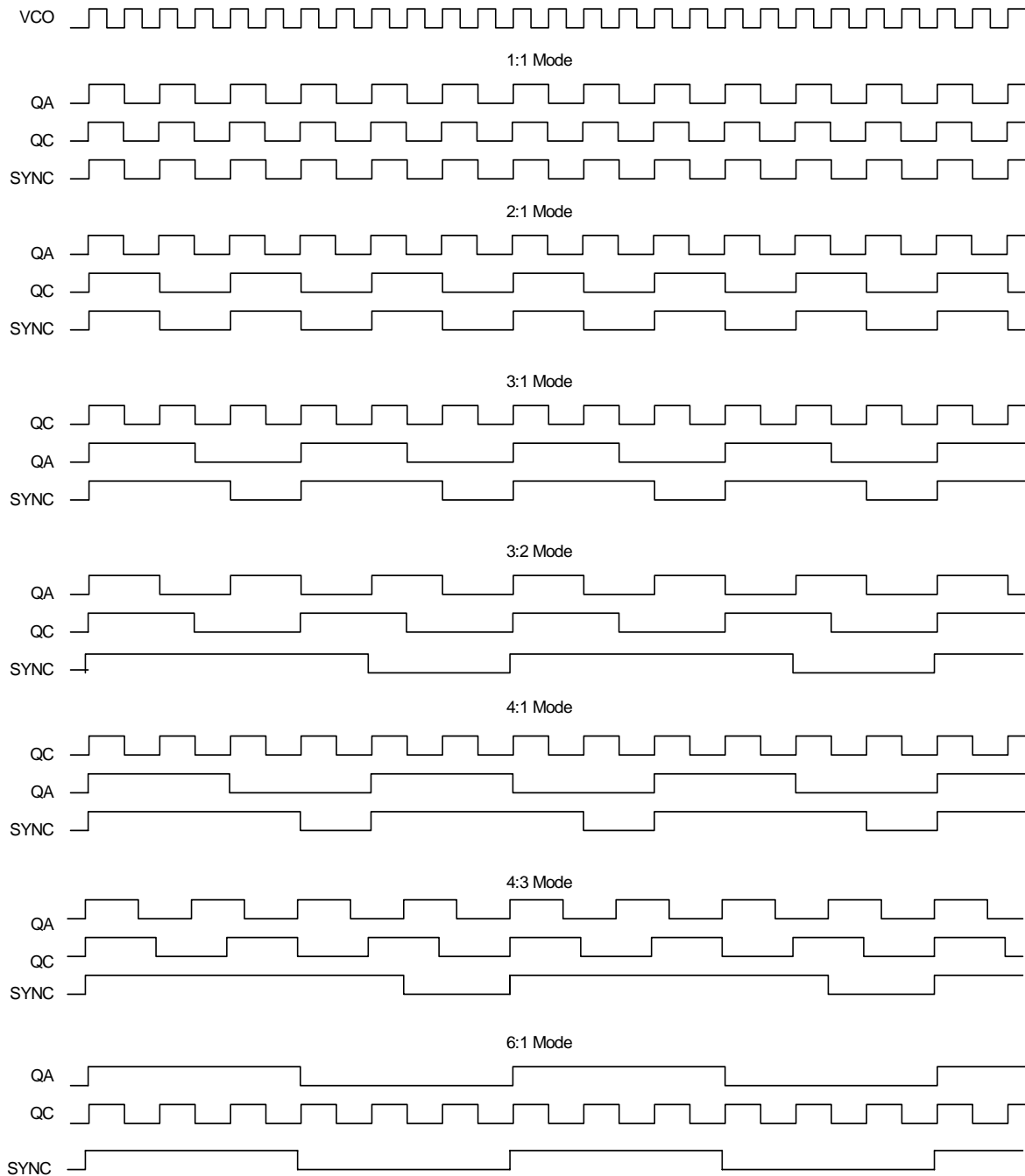

Figure 1.

Power Management

The individual output enable/freeze control of the CY29773 allows the user to implement unique power management schemes into the design. The outputs are stopped in the logic '0' state when the freeze control bits are activated. The serial input register contains one programmable freeze enable bit for 12 of the 14 output clocks. The QC0 and FB_OUT outputs can not be frozen with the serial port, this avoids any potential lock up situation should an error occur in the loading of the serial

data. An output is frozen when a logic '0' is programmed and enabled when a logic '1' is written. The enabling and freezing of individual outputs is done in such a manner as to eliminate the possibility of partial "runt" clocks.

The serial input register is programmed through the SDATA input by writing a logic '0' start bit followed by 12 NRZ freeze enable bits. The period of each SDATA bit equals the period of the free running SCLK signal. The SDATA is sampled on the rising edge of SCLK.

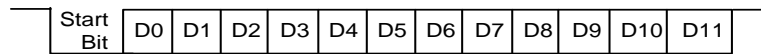

D0-D3 are the control bits for QA0-QA3, respectively
 D4-D7 are the control bits for QB0-QB3, respectively
 D8-D10 are the control bits for QC1-QC3, respectively
 D11 is the control bit for SYNC

Figure 2.

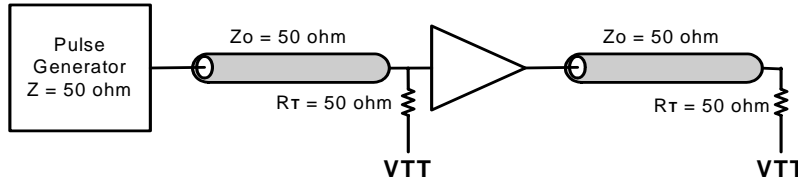

Figure 3. LVC MOS_CLK AC Test Reference for $V_{DD} = 3.3V/2.5V$

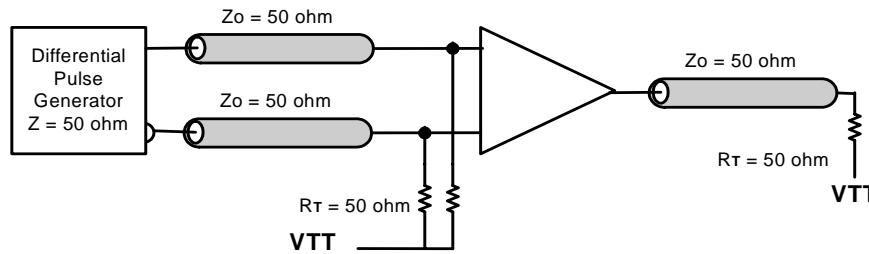

Figure 4. PECL_CLK AC Test Reference for $V_{DD} = 3.3V/2.5V$

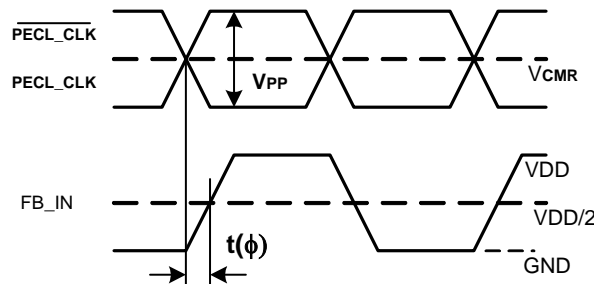

Figure 5. LVPECL Propagation Delay $t(\phi)$, Static Phase Offset

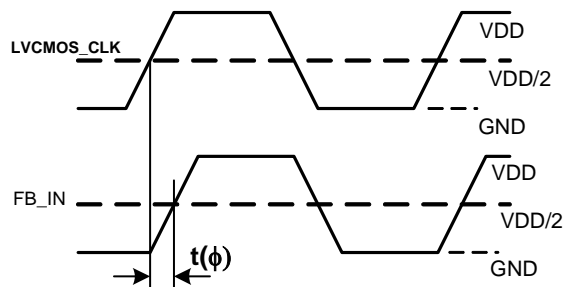

Figure 6. LVC MOS Propagation Delay $t(\phi)$, Static Phase Offset

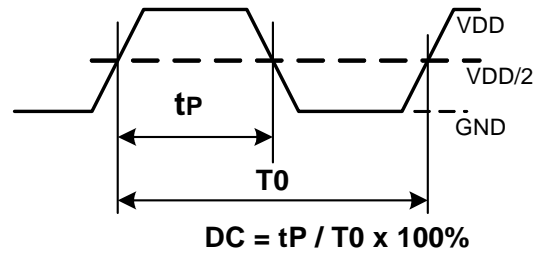

Figure 7. Output Duty Cycle (DC)

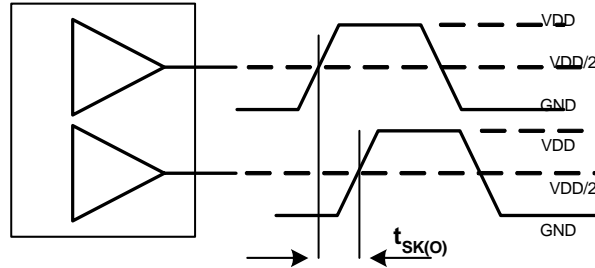

Figure 8. Output-to-Output Skew, $t_{sk(O)}$

Ordering Information

Part Number	Package Type	Product Flow
CY29773AI	52-pin TQFP	Industrial, -40°C to +85°C
CY29773AIT	52-pin TQFP – Tape and Reel	Industrial, -40°C to 85°C
Lead-free		
CY29773AXI	52-pin TQFP	Industrial, -40°C to +85°C
CY29773AXIT	52-pin TQFP – Tape and Reel	Industrial, -40°C to 85°C

Package Drawing and Dimension

52-Lead Thin Plastic Quad Flat Pack (10 x 10 x 1.0 mm) A52B

DIMENSIONS ARE IN MILLIMETERS

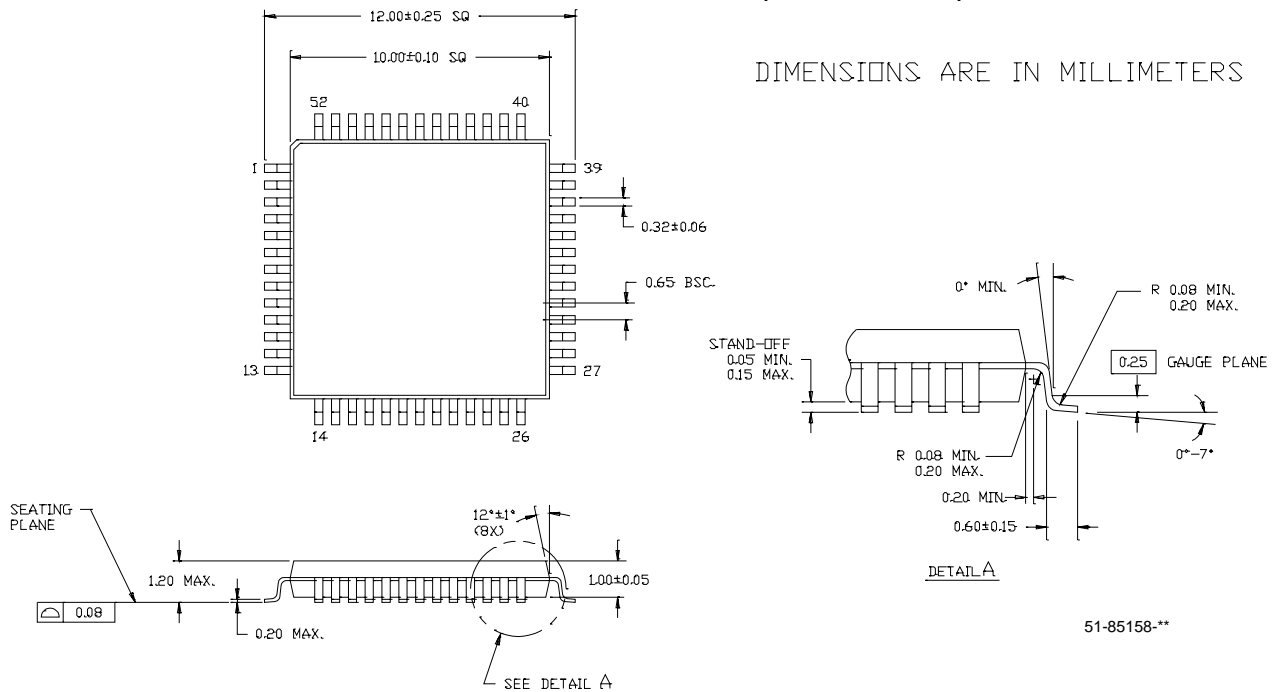

Spread Aware is a trademark of Cypress Semiconductor. All product and company names mentioned in this document are the trademarks of their respective holders.

Document History Page

Document Title:CY29773 2.5V or 3.3V, 200-MHz, 12-Output Zero Delay Buffer Document Number: 38-07573				
REV.	ECN No.	Issue Date	Orig. of Change	Description of Change
**	129007	09/02/03	RGL	New Data Sheet
*A	404290	See ECN	RGL	Added pb-free devices added typical data for period jitter