

# ADC14C105

## 14-Bit, 95/105 MSPS A/D Converter

### General Description

The ADC14C105 is a high-performance CMOS analog-to-digital converter capable of converting analog input signals into 14-bit digital words at rates up to 105 Mega Samples Per Second (MSPS). This converter uses a differential, pipelined architecture with digital error correction and an on-chip sample-and-hold circuit to minimize power consumption and the external component count, while providing excellent dynamic performance. A unique sample-and-hold stage yields a full-power bandwidth of 1 GHz. The ADC14C105 may be operated from a single +3.0V or +3.3V power supply and consumes low power.

A separate +2.5V supply may be used for the digital output interface which allows lower power operation with reduced noise. A power-down feature reduces the power consumption to very low levels while still allowing fast wake-up time to full operation. The differential inputs accept a 2V full scale differential input swing. A stable 1.2V internal voltage reference is provided, or the ADC14C105 can be operated with an external 1.2V reference. Output data format (offset binary versus 2's complement) and duty cycle stabilizer are pin-selectable. The duty cycle stabilizer maintains performance over a wide range of clock duty cycles.

The ADC14C105 is available in a 32-lead LLP package and operates over the industrial temperature range of  $-40^{\circ}\text{C}$  to  $+85^{\circ}\text{C}$ .

### Features

- 1 GHz Full Power Bandwidth
- Internal reference and sample-and-hold circuit
- Low power consumption
- Data Ready output clock
- Clock Duty Cycle Stabilizer
- Single +3.0V or +3.3V supply operation
- Power-down mode
- 32-pin LLP package, (5x5x0.8mm, 0.5mm pin-pitch)

### Key Specifications

■ Resolution	14 Bits
■ Conversion Rate	105 MSPS
■ SNR ( $f_{IN} = 240$ MHz)	71 dBFS (typ)
■ SFDR ( $f_{IN} = 240$ MHz)	82 dBFS (typ)
■ Full Power Bandwidth	1 GHz (typ)
■ Power Consumption	350 mW (typ, $V_A=3.0\text{V}$ )
■	400 mW (typ, $V_A=3.3\text{V}$ )

### Applications

- High IF Sampling Receivers
- Wireless Base Station Receivers
- Test and Measurement Equipment
- Communications Instrumentation
- Portable Instrumentation

### Connection Diagram

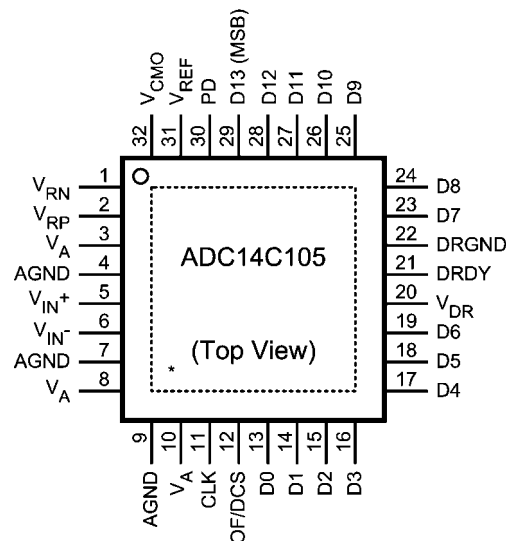

30017901

### Block Diagram

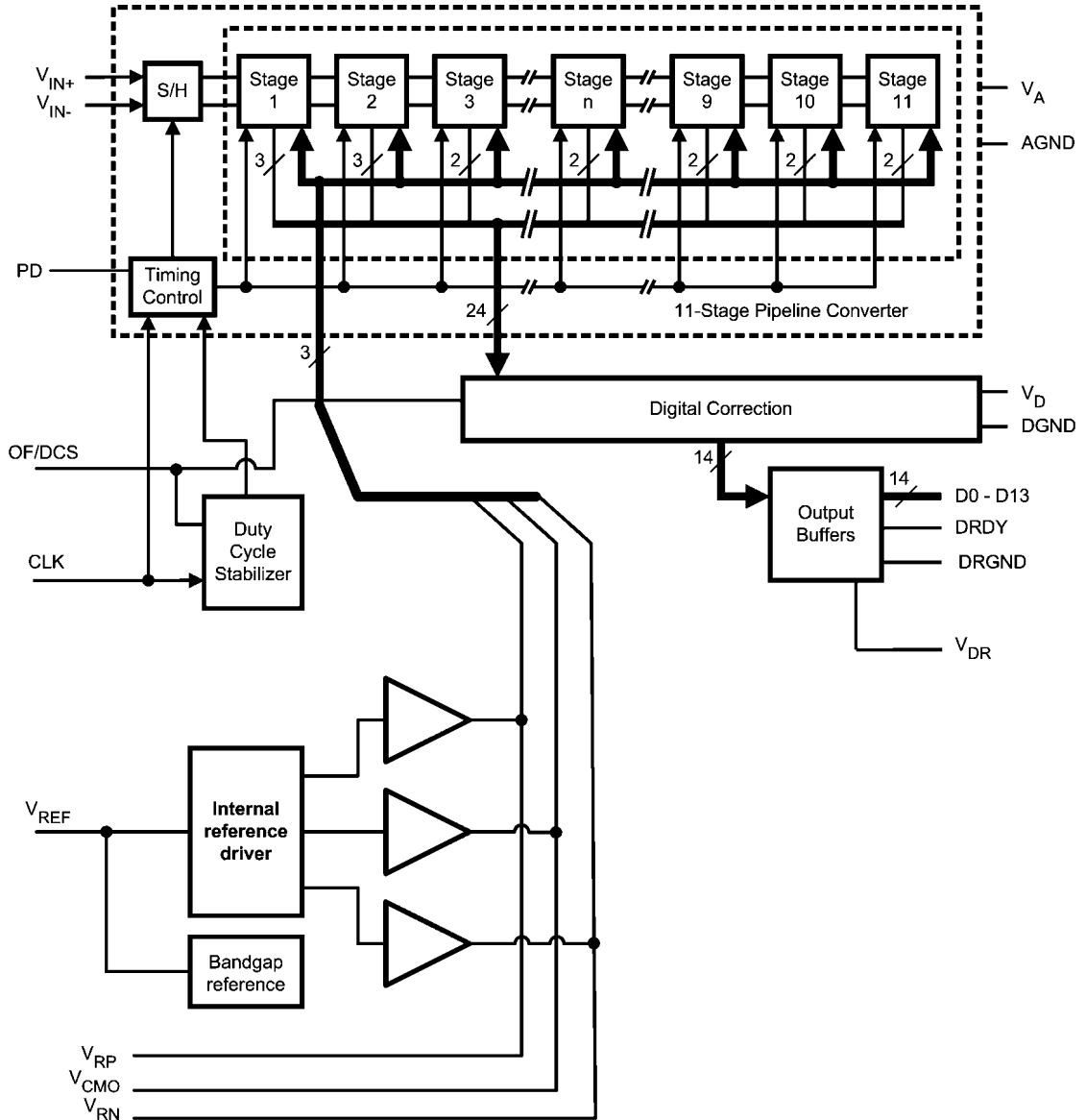

30017902

### Ordering Information

Industrial ( $-40^{\circ}\text{C} \leq T_A \leq +85^{\circ}\text{C}$ )	Package
ADC14C105CISQ	32 Pin LLP
ADC14C105CISQE	32 Pin LLP, 250-Piece Tape and Reel
ADC14C105EB	Evaluation Board

## Pin Descriptions and Equivalent Circuits

Pin No.	Symbol	Equivalent Circuit	Description
<b>ANALOG I/O</b>			
5	$V_{IN+}$		<p>Differential analog input pins. The differential full-scale input signal level is <math>2V_{P-P}</math> with each input pin signal centered on a common mode voltage, <math>V_{CM}</math>.</p>
6	$V_{IN-}$		
2	$V_{RP}$		<p>These pins should each be bypassed to AGND with a low ESL (equivalent series inductance) <math>0.1 \mu F</math> capacitor placed very close to the pin to minimize stray inductance. A <math>0.1 \mu F</math> capacitor should be placed between <math>V_{RP}</math> and <math>V_{RN}</math> as close to the pins as possible, and a <math>1 \mu F</math> capacitor should be placed in parallel. <math>V_{RP}</math> and <math>V_{RN}</math> should not be loaded. <math>V_{CMO}</math> may be loaded to 1mA for use as a temperature stable 1.5V reference. It is recommended to use <math>V_{CMO}</math> to provide the common mode voltage, <math>V_{CM}</math>, for the differential analog inputs, <math>V_{IN+}</math> and <math>V_{IN-}</math>.</p>
32	$V_{CMO}$		
1	$V_{RN}$		
31	$V_{REF}$		<p>Reference Voltage. This device provides an internally developed 1.2V reference. When using the internal reference, <math>V_{REF}</math> should be decoupled to AGND with a <math>0.1 \mu F</math> and a <math>1 \mu F</math> low equivalent series inductance (ESL) capacitor. This pin may be driven with an external 1.2V reference voltage. This pin should not be used to source or sink current.</p>
12	OF/DCS		<p>This is a four-state pin controlling the input clock mode and output data format.            OF/DCS = <math>V_A</math>, output data format is 2's complement without duty cycle stabilization applied to the input clock            OF/DCS = AGND, output data format is offset binary, without duty cycle stabilization applied to the input clock.            OF/DCS = <math>(2/3)V_A</math>, output data is 2's complement with duty cycle stabilization applied to the input clock            OF/DCS = <math>(1/3)V_A</math>, output data is offset binary with duty cycle stabilization applied to the input clock.</p>
<b>DIGITAL I/O</b>			
11	CLK		<p>The clock input pin.            The analog input is sampled on the rising edge of the clock input.</p>
30	PD		<p>This is a two-state input controlling Power Down.            PD = <math>V_A</math>, Power Down is enabled and power dissipation is reduced.            PD = AGND, Normal operation.</p>

Pin No.	Symbol	Equivalent Circuit	Description
13-19, 23-29	D0-D13		Digital data output pins that make up the 14-bit conversion result. D0 (pin 13) is the LSB, while D13 (pin 29) is the MSB of the output word. Output levels are CMOS compatible.
21	DRDY		Data Ready Strobe. The data output transition is synchronized with the falling edge of this signal. This signal switches at the same frequency as the CLK input.
<b>ANALOG POWER</b>			
3, 8, 10	$V_A$		Positive analog supply pins. These pins should be connected to a quiet voltage source and be bypassed to AGND with 0.1 $\mu\text{F}$ capacitors located close to the power pins.
4, 7, 9, Exposed Pad	AGND		The ground return for the analog supply. The exposed pad on back of package must be soldered to ground plane to ensure rated performance.
<b>DIGITAL POWER</b>			
20	$V_{DR}$		Positive driver supply pin for the output drivers. This pin should be connected to a quiet voltage source and be bypassed to DRGND with a 0.1 $\mu\text{F}$ capacitor located close to the power pin.
22	DRGND		The ground return for the digital output driver supply. This pins should be connected to the system digital ground, but not be connected in close proximity to the ADC's AGND pins.

**Absolute Maximum Ratings** (Notes 1, 3)

If Military/Aerospace specified devices are required, please contact the National Semiconductor Sales Office/Distributors for availability and specifications.

Supply Voltage ( $V_A$ , $V_{DR}$ )	-0.3V to 4.2V
Voltage on Any Pin (Not to exceed 4.2V)	-0.3V to ( $V_A$ +0.3V)
Input Current at Any Pin other than Supply Pins (Note 4)	±5 mA
Package Input Current (Note 4)	±50 mA
Max Junction Temp ( $T_J$ )	+150°C
Thermal Resistance ( $\theta_{JA}$ )	30°C/W
ESD Rating	
Human Body Model (Note 6)	2500V
Machine Model (Note 6)	250V
Storage Temperature	-65°C to +150°C

Soldering process must comply with National Semiconductor's Reflow Temperature Profile specifications. Refer to [www.national.com/packaging](http://www.national.com/packaging). (Note 7)

**Operating Ratings** (Notes 1, 3)

Operating Temperature	$-40^\circ\text{C} \leq T_A \leq +85^\circ\text{C}$
Supply Voltage ( $V_A$ )	+2.7V to +3.6V
Output Driver Supply ( $V_{DR}$ )	+2.4V to $V_A$
Clock Duty Cycle	
(DCS Enabled)	30/70 %
(DCS disabled)	45/55 %
$V_{CM}$	1.4V to 1.6V
IAGND-DRGNDI	≤100mV

**Converter Electrical Characteristics**

Unless otherwise specified, the following specifications apply: AGND = DRGND = 0V,  $V_A = +3.3\text{V}$ ,  $V_{DR} = +2.5\text{V}$ , Internal  $V_{REF} = +1.2\text{V}$ ,  $f_{CLK} = 105\text{ MHz}$ , 50% Duty Cycle, DCS disabled,  $V_{CM} = V_{CMO}$ ,  $C_L = 5\text{ pF/pin}$ . Typical values are for  $T_A = 25^\circ\text{C}$ . **Boldface limits apply for  $T_{MIN} \leq T_A \leq T_{MAX}$** . All other limits apply for  $T_A = 25^\circ\text{C}$  (Notes 8, 9)

Symbol	Parameter	Conditions	Typical (Note 10)	Limits	Units (Limits)
<b>STATIC CONVERTER CHARACTERISTICS</b>					
	Resolution with No Missing Codes			<b>14</b>	Bits (min)
INL	Integral Non Linearity		±1.8	<b>4</b> <b>-4</b>	LSB (max) LSB (min)
DNL	Differential Non Linearity		±0.5	<b>1.3</b> <b>-0.9</b>	LSB (max) LSB (min)
PGE	Positive Gain Error		-0.05	<b>±1.25</b>	%FS (max)
NGE	Negative Gain Error		-0.54	<b>±1.25</b>	%FS (max)
TC PGE	Positive Gain Error Tempco	$-40^\circ\text{C} \leq T_A \leq +85^\circ\text{C}$	-8		ppm/°C
TC NGE	Negative Gain Error Tempco	$-40^\circ\text{C} \leq T_A \leq +85^\circ\text{C}$	-7		ppm/°C
$V_{OFF}$	Offset Error ( $V_{IN+} = V_{IN-}$ )		0.065	<b>±0.55</b>	%FS (max)
TC $V_{OFF}$	Offset Error Tempco	$-40^\circ\text{C} \leq T_A \leq +85^\circ\text{C}$	7.5		ppm/°C
	Under Range Output Code		0	<b>0</b>	
	Over Range Output Code		16383	<b>16383</b>	
<b>REFERENCE AND ANALOG INPUT CHARACTERISTICS</b>					
$V_{CMO}$	Common Mode Output Voltage		1.5	<b>1.4</b> <b>1.56</b>	V (min) V (max)
$V_{CM}$	Analog Input Common Mode Voltage		1.5	1.4 1.6	V (min) V (max)
$C_{IN}$	$V_{IN}$ Input Capacitance (each pin to GND) (Note 11)	$V_{IN} = 1.5\text{ Vdc}$ ± 0.5 V	(CLK LOW)	8.5	pF
			(CLK HIGH)	3.5	pF
$V_{REF}$	Internal Reference Voltage		1.18		V
TC $V_{REF}$	Internal Reference Voltage Tempco	$-40^\circ\text{C} \leq T_A \leq +85^\circ\text{C}$	18		ppm/°C
$V_{RP}$	Internal Reference top	(Note 13)	1.98	1.89	V (min)
				2.06	V (max)

Symbol	Parameter	Conditions	Typical (Note 10)	Limits	Units (Limits)
$V_{RN}$	Internal Reference bottom	(Note 13)	0.98	0.89 1.06	V (min) V (max)
Ext $V_{REF}$	External Reference Voltage	(Note 13)	1.20	1.176 1.224	V (min) V (max)

## Dynamic Converter Electrical Characteristics

Unless otherwise specified, the following specifications apply: AGND = DRGND = 0V,  $V_A = +3.3V$ ,  $V_{DR} = +2.5V$ , Internal  $V_{REF} = +1.2V$ ,  $f_{CLK} = 105$  MHz, 50% Duty Cycle, DCS disabled,  $V_{CM} = V_{CMO}$ ,  $C_L = 5$  pF/pin. Typical values are for  $T_A = 25^\circ C$ . **Boldface limits apply for  $T_{MIN} \leq T_A \leq T_{MAX}$ .** All other limits apply for  $T_A = 25^\circ C$  (Notes 8, 9)

Symbol	Parameter	Conditions	Typical (Note 10)	Limits	Units (Limits) (Note 2)
<b>DYNAMIC CONVERTER CHARACTERISTICS, <math>A_{IN} = -1dBFS</math></b>					
FPBW	Full Power Bandwidth	-1 dBFS Input, -3 dB Corner	1.0		GHz
SNR	Signal-to-Noise Ratio	$f_{IN} = 10$ MHz	74		dBFS
		$f_{IN} = 70$ MHz	73.5		dBFS
		$f_{IN} = 240$ MHz	71	<b>69.4</b>	dBFS
SFDR	Spurious Free Dynamic Range	$f_{IN} = 10$ MHz	90		dBFS
		$f_{IN} = 70$ MHz	86		dBFS
		$f_{IN} = 240$ MHz	82	<b>78</b>	dBFS
ENOB	Effective Number of Bits	$f_{IN} = 10$ MHz	11.9		Bits
		$f_{IN} = 70$ MHz	11.8		Bits
		$f_{IN} = 240$ MHz	11.4	<b>11.1</b>	Bits
THD	Total Harmonic Distortion	$f_{IN} = 10$ MHz	-86		dBFS
		$f_{IN} = 70$ MHz	-85		dBFS
		$f_{IN} = 240$ MHz	-79.3	<b>-74</b>	dBFS
H2	Second Harmonic Distortion	$f_{IN} = 10$ MHz	-95		dBFS
		$f_{IN} = 70$ MHz	-90		dBFS
		$f_{IN} = 240$ MHz	-86	<b>-78</b>	dBFS
H3	Third Harmonic Distortion	$f_{IN} = 10$ MHz	-90		dBFS
		$f_{IN} = 70$ MHz	-86		dBFS
		$f_{IN} = 240$ MHz	-82	<b>-78</b>	dBFS
SINAD	Signal-to-Noise and Distortion Ratio	$f_{IN} = 10$ MHz	73.5		dBFS
		$f_{IN} = 70$ MHz	73		dBFS
		$f_{IN} = 240$ MHz	70.4	<b>68.8</b>	dBFS
IMD	Intermodulation Distortion	$f_{IN} = 19.5$ MHz and 20.5MHz, each -7 dBFS	-82		dBFS

## Logic and Power Supply Electrical Characteristics

Unless otherwise specified, the following specifications apply: AGND = DRGND = 0V,  $V_A = +3.3V$ ,  $V_{DR} = +2.5V$ , Internal  $V_{REF} = +1.2V$ ,  $f_{CLK} = 105$  MHz, 50% Duty Cycle, DCS disabled,  $V_{CM} = V_{CMO}$ ,  $C_L = 5$  pF/pin. Typical values are for  $T_A = 25^\circ C$ . **Boldface limits apply for  $T_{MIN} \leq T_A \leq T_{MAX}$ .** All other limits apply for  $T_A = 25^\circ C$  (Notes 8, 9)

Symbol	Parameter	Conditions	Typical (Note 10)	Limits	Units (Limits)
<b>DIGITAL INPUT CHARACTERISTICS (CLK, PD)</b>					
$V_{IN(1)}$	Logical "1" Input Voltage	$V_D = 3.6V$		<b>2.0</b>	V (min)
$V_{IN(0)}$	Logical "0" Input Voltage	$V_D = 3.0V$		<b>0.8</b>	V (max)
$I_{IN(1)}$	Logical "1" Input Current	$V_{IN} = 3.3V$	10		$\mu A$
$I_{IN(0)}$	Logical "0" Input Current	$V_{IN} = 0V$	-10		$\mu A$

Symbol	Parameter	Conditions	Typical (Note 10)	Limits	Units (Limits)
$C_{IN}$	Digital Input Capacitance		5		pF
<b>DIGITAL OUTPUT CHARACTERISTICS (D0–D13, DRDY)</b>					
$V_{OUT(1)}$	Logical “1” Output Voltage	$I_{OUT} = -0.5 \text{ mA}$ , $V_{DR} = 2.4\text{V}$		<b>2.0</b>	V (min)
$V_{OUT(0)}$	Logical “0” Output Voltage	$I_{OUT} = 1.6 \text{ mA}$ , $V_{DR} = 2.4\text{V}$		<b>0.4</b>	V (max)
$+I_{SC}$	Output Short Circuit Source Current	$V_{OUT} = 0\text{V}$	-10		mA
$-I_{SC}$	Output Short Circuit Sink Current	$V_{OUT} = V_{DR}$	10		mA
$C_{OUT}$	Digital Output Capacitance		5		pF
<b>POWER SUPPLY CHARACTERISTICS</b>					
$I_A$	Analog Supply Current	Full Operation	121	<b>141</b>	mA (max)
$I_{DR}$	Digital Output Supply Current	Full Operation (Note 12)	16		mA
	Power Consumption	Excludes $I_{DR}$ (Note 12)	400	<b>466</b>	mW (max)
	Power Down Power Consumption	Clock disabled	7.5		mW

## Timing and AC Characteristics

Unless otherwise specified, the following specifications apply:  $AGND = DRGND = 0\text{V}$ ,  $V_A = +3.3\text{V}$ ,  $V_{DR} = +2.5\text{V}$ , Internal  $V_{REF} = +1.2\text{V}$ ,  $f_{CLK} = 105 \text{ MHz}$ , 50% Duty Cycle, DCS disabled,  $V_{CM} = V_{CMO}$ ,  $C_L = 5 \text{ pF/pin}$ . Typical values are for  $T_A = 25^\circ\text{C}$ . Timing measurements are taken at 50% of the signal amplitude. **Boldface limits apply for  $T_{MIN} \leq T_A \leq T_{MAX}$** . All other limits apply for  $T_A = 25^\circ\text{C}$  (Notes 8, 9)

Symb	Parameter	Conditions	Typical (Note 10)	Limits	Units (Limits)
	Maximum Clock Frequency			<b>105</b>	MHz (max)
	Minimum Clock Frequency			<b>20</b>	MHz (min)
$t_{CH}$	Clock High Time		4		ns
$t_{CL}$	Clock Low Time		4		ns
$t_{CONV}$	Conversion Latency			<b>7</b>	Clock Cycles
$t_{OD}$	Output Delay of CLK to DATA	Relative to rising edge of CLK(Note 13)	5.76	3	ns (min)
				7.3	ns (max)
$t_{SU}$	Data Output Setup Time	Relative to DRDY	4.5	<b>3.7</b>	ns (min)
$t_H$	Data Output Hold Time	Relative to DRDY	4.5	<b>3.8</b>	ns (min)
$t_{AD}$	Aperture Delay		0.6		ns
$t_{AJ}$	Aperture Jitter		0.1		ps rms

## Dynamic Converter Electrical Characteristics at 95MSPS

Unless otherwise specified, the following specifications apply: AGND = DRGND = 0V,  $V_A = +3.3V$ ,  $V_{DR} = +2.5V$ , Internal  $V_{REF} = +1.2V$ ,  $f_{CLK} = 95$  MHz, 50% Duty Cycle, DCS disabled,  $V_{CM} = V_{CMO}$ ,  $C_L = 5$  pF/pin, . Typical values are for  $T_A = 25^\circ C$ . **Boldface limits apply for  $T_{MIN} \leq T_A \leq T_{MAX}$ .** All other limits apply for  $T_A = 25^\circ C$  (Notes 8, 9)

Symbol	Parameter	Conditions	Typical (Note 10)	Limits	Units (Limits) (Note 2)
<b>DYNAMIC CONVERTER CHARACTERISTICS, <math>A_{IN} = -1dBFS</math></b>					
SNR	Signal-to-Noise Ratio	$f_{IN} = 10$ MHz	74		dBFS
		$f_{IN} = 70$ MHz	73.5		dBFS
		$f_{IN} = 240$ MHz	71		dBFS
SFDR	Spurious Free Dynamic Range	$f_{IN} = 10$ MHz	90		dBFS
		$f_{IN} = 70$ MHz	86		dBFS
		$f_{IN} = 240$ MHz	82		dBFS
ENOB	Effective Number of Bits	$f_{IN} = 10$ MHz	11.9		Bits
		$f_{IN} = 70$ MHz	11.8		Bits
		$f_{IN} = 240$ MHz	11.4		Bits
THD	Total Harmonic Distortion	$f_{IN} = 10$ MHz	-86		dBFS
		$f_{IN} = 70$ MHz	-85		dBFS
		$f_{IN} = 240$ MHz	-80		dBFS
H2	Second Harmonic Distortion	$f_{IN} = 10$ MHz	-95		dBFS
		$f_{IN} = 70$ MHz	-90		dBFS
		$f_{IN} = 240$ MHz	-85		dBFS
H3	Third Harmonic Distortion	$f_{IN} = 10$ MHz	-90		dBFS
		$f_{IN} = 70$ MHz	-86		dBFS
		$f_{IN} = 240$ MHz	-83		dBFS
SINAD	Signal-to-Noise and Distortion Ratio	$f_{IN} = 10$ MHz	73.5		dBFS
		$f_{IN} = 70$ MHz	73		dBFS
		$f_{IN} = 240$ MHz	70.5		dBFS
<b>POWER SUPPLY CHARACTERISTICS</b>					
$I_A$	Analog Supply Current	Full Operation	115		mA (max)
$I_{DR}$	Digital Output Supply Current	Full Operation (Note 12)	14.5		mA
	Power Consumption	Excludes $I_{DR}$ (Note 12)	380		mW (max)

**Note 1:** Absolute Maximum Ratings indicate limits beyond which damage to the device may occur. Operating Ratings indicate conditions for which the device is guaranteed to be functional, but do not guarantee specific performance limits. For guaranteed specifications and test conditions, see the Electrical Characteristics. The guaranteed specifications apply only for the test conditions listed. Some performance characteristics may degrade when the device is not operated under the listed test conditions. Operation of the device beyond the maximum Operating Ratings is not recommended.

**Note 2:** Parameters specified in dBFS indicate the value that would be attained with a full-scale input signal.

**Note 3:** All voltages are measured with respect to GND = AGND = DRGND = 0V, unless otherwise specified.

**Note 4:** When the input voltage at any pin exceeds the power supplies (that is,  $V_{IN} < AGND$ , or  $V_{IN} > V_A$ ), the current at that pin should be limited to  $\pm 5$  mA. The  $\pm 50$  mA maximum package input current rating limits the number of pins that can safely exceed the power supplies with an input current of  $\pm 5$  mA to 10.

**Note 5:** The maximum allowable power dissipation is dictated by  $T_{J,max}$ , the junction-to-ambient thermal resistance, ( $\theta_{JA}$ ), and the ambient temperature, ( $T_A$ ), and can be calculated using the formula  $P_{D,max} = (T_{J,max} - T_A) / \theta_{JA}$ . The values for maximum power dissipation listed above will be reached only when the device is operated in a severe fault condition (e.g. when input or output pins are driven beyond the power supply voltages, or the power supply polarity is reversed). Such conditions should always be avoided.

**Note 6:** Human Body Model is 100 pF discharged through a 1.5 k $\Omega$  resistor. Machine Model is 220 pF discharged through 0  $\Omega$

**Note 7:** Reflow temperature profiles are different for lead-free and non-lead-free packages.

**Note 8:** The inputs are protected as shown below. Input voltage magnitudes above  $V_A$  or below GND will not damage this device, provided current is limited per (Note 4). However, errors in the A/D conversion can occur if the input goes above 2.6V or below GND as described in the Operating Ratings section.



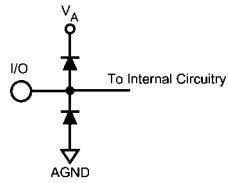

30017911

**Note 9:** With a full scale differential input of  $2V_{P-P}$ , the 14-bit LSB is 122.1  $\mu$ V.

**Note 10:** Typical figures are at  $T_A = 25^\circ\text{C}$  and represent most likely parametric norms at the time of product characterization. The typical specifications are not guaranteed.

**Note 11:** The input capacitance is the sum of the package/pin capacitance and the sample and hold circuit capacitance.

**Note 12:**  $I_{DR}$  is the current consumed by the switching of the output drivers and is primarily determined by load capacitance on the output pins, the supply voltage,  $V_{DR}$ , and the rate at which the outputs are switching (which is signal dependent).  $I_{DR} = V_{DR}(C_0 \times f_0 + C_1 \times f_1 + \dots + C_{13} \times f_{13})$  where  $V_{DR}$  is the output driver power supply voltage,  $C_n$  is total capacitance on the output pin, and  $f_n$  is the average frequency at which that pin is toggling.

**Note 13:** This parameter is guaranteed by design and/or characterization and is not tested in production.

## Specification Definitions

**APERTURE DELAY** is the time after the falling edge of the clock to when the input signal is acquired or held for conversion.

**APERTURE JITTER (APERTURE UNCERTAINTY)** is the variation in aperture delay from sample to sample. Aperture jitter manifests itself as noise in the output.

**CLOCK DUTY CYCLE** is the ratio of the time during one cycle that a repetitive digital waveform is high to the total time of one period. The specification here refers to the ADC clock input signal.

**COMMON MODE VOLTAGE ( $V_{CM}$ )** is the common DC voltage applied to both input terminals of the ADC.

**CONVERSION LATENCY** is the number of clock cycles between initiation of conversion and when that data is presented to the output driver stage. Data for any given sample is available at the output pins the Pipeline Delay plus the Output Delay after the sample is taken. New data is available at every clock cycle, but the data lags the conversion by the pipeline delay.

**DIFFERENTIAL NON-LINEARITY (DNL)** is the measure of the maximum deviation from the ideal step size of 1 LSB.

**EFFECTIVE NUMBER OF BITS (ENOB, or EFFECTIVE BITS)** is another method of specifying Signal-to-Noise and Distortion Ratio or SINAD. ENOB is defined as  $(\text{SINAD} - 1.76) / 6.02$  and says that the converter is equivalent to a perfect ADC of this (ENOB) number of bits.

**FULL POWER BANDWIDTH** is a measure of the frequency at which the reconstructed output fundamental drops 3 dB below its low frequency value for a full scale input.

**GAIN ERROR** is the deviation from the ideal slope of the transfer function. It can be calculated as:

$$\text{Gain Error} = \text{Positive Full Scale Error} - \text{Negative Full Scale Error}$$

It can also be expressed as Positive Gain Error and Negative Gain Error, which are calculated as:

$$\begin{aligned} \text{PGE} &= \text{Positive Full Scale Error} - \text{Offset Error} \\ \text{NGE} &= \text{Offset Error} - \text{Negative Full Scale Error} \end{aligned}$$

**INTEGRAL NON LINEARITY (INL)** is a measure of the deviation of each individual code from a best fit straight line. The deviation of any given code from this straight line is measured from the center of that code value.

**INTERMODULATION DISTORTION (IMD)** is the creation of additional spectral components as a result of two sinusoidal frequencies being applied to the ADC input at the same time. It is defined as the ratio of the power in the intermodulation products to the total power in the original frequencies. IMD is usually expressed in dBFS.

**LSB (LEAST SIGNIFICANT BIT)** is the bit that has the smallest value or weight of all bits. This value is  $V_{FS}/2^n$ , where " $V_{FS}$ " is the full scale input voltage and " $n$ " is the ADC resolution in bits.

**MISSING CODES** are those output codes that will never appear at the ADC outputs. The ADC14C105 is guaranteed not to have any missing codes.

**MSB (MOST SIGNIFICANT BIT)** is the bit that has the largest value or weight. Its value is one half of full scale.

**NEGATIVE FULL SCALE ERROR** is the difference between the actual first code transition and its ideal value of  $1/2$  LSB above negative full scale.

**OFFSET ERROR** is the difference between the two input voltages  $[(V_{IN+}) - (V_{IN-})]$  required to cause a transition from code 8191 to 8192.

**OUTPUT DELAY** is the time delay after the falling edge of the clock before the data update is presented at the output pins.

**PIPELINE DELAY (LATENCY)** See CONVERSION LATENCY.

**POSITIVE FULL SCALE ERROR** is the difference between the actual last code transition and its ideal value of  $1/2$  LSB below positive full scale.

**POWER SUPPLY REJECTION RATIO (PSRR)** is a measure of how well the ADC rejects a change in the power supply voltage. PSRR is the ratio of the Full-Scale output of the ADC with the supply at the minimum DC supply limit to the Full-Scale output of the ADC with the supply at the maximum DC supply limit, expressed in dB.

**SIGNAL TO NOISE RATIO (SNR)** is the ratio, expressed in dB, of the rms value of the input signal to the rms value of the sum of all other spectral components below one-half the sampling frequency, not including harmonics or DC.

**SIGNAL TO NOISE PLUS DISTORTION (S/N+D or SINAD)** is the ratio, expressed in dB, of the rms value of the input signal to the rms value of all of the other spectral components below half the clock frequency, including harmonics but excluding d.c.

**SPURIOUS FREE DYNAMIC RANGE (SFDR)** is the difference, expressed in dB, between the rms values of the input signal and the peak spurious signal, where a spurious signal is any signal present in the output spectrum that is not present at the input.

**TOTAL HARMONIC DISTORTION (THD)** is the ratio, expressed in dB, of the rms total of the first six harmonic levels at the output to the level of the fundamental at the output. THD is calculated as

$$\text{THD} = 20 \times \log \sqrt{\frac{f_2^2 + \dots + f_7^2}{f_1^2}}$$

where  $f_1$  is the RMS power of the fundamental (output) frequency and  $f_2$  through  $f_7$  are the RMS power of the first six harmonic frequencies in the output spectrum.

**SECOND HARMONIC DISTORTION (2ND HARM)** is the difference expressed in dB, between the RMS power in the input frequency at the output and the power in its 2nd harmonic level at the output.

**THIRD HARMONIC DISTORTION (3RD HARM)** is the difference, expressed in dB, between the RMS power in the input frequency at the output and the power in its 3rd harmonic level at the output.

### Timing Diagram

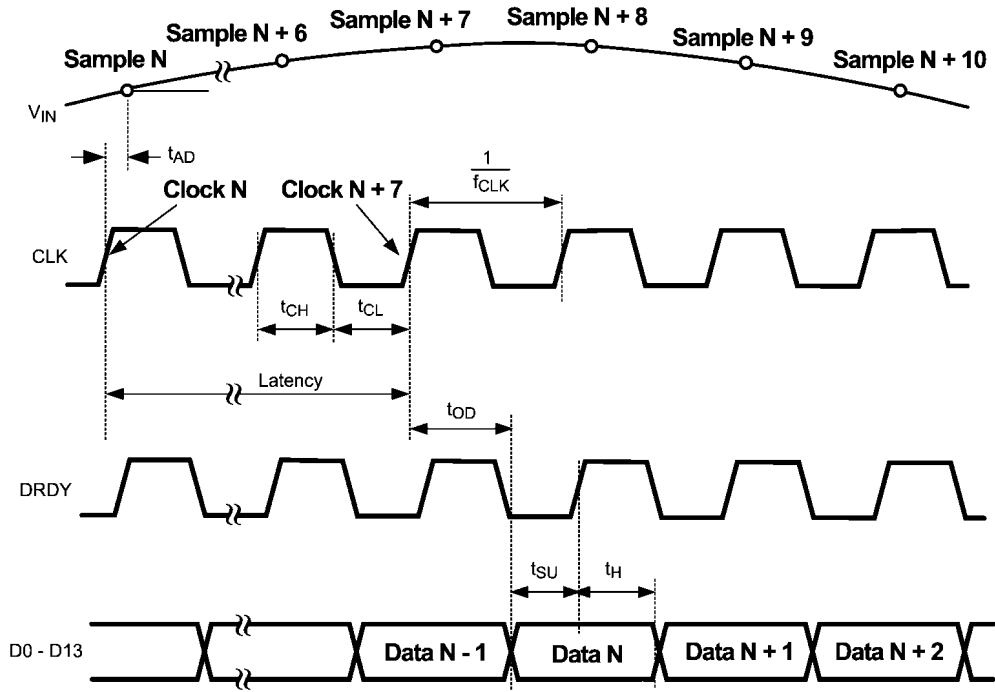

30017909

FIGURE 1. Output Timing

### Transfer Characteristic

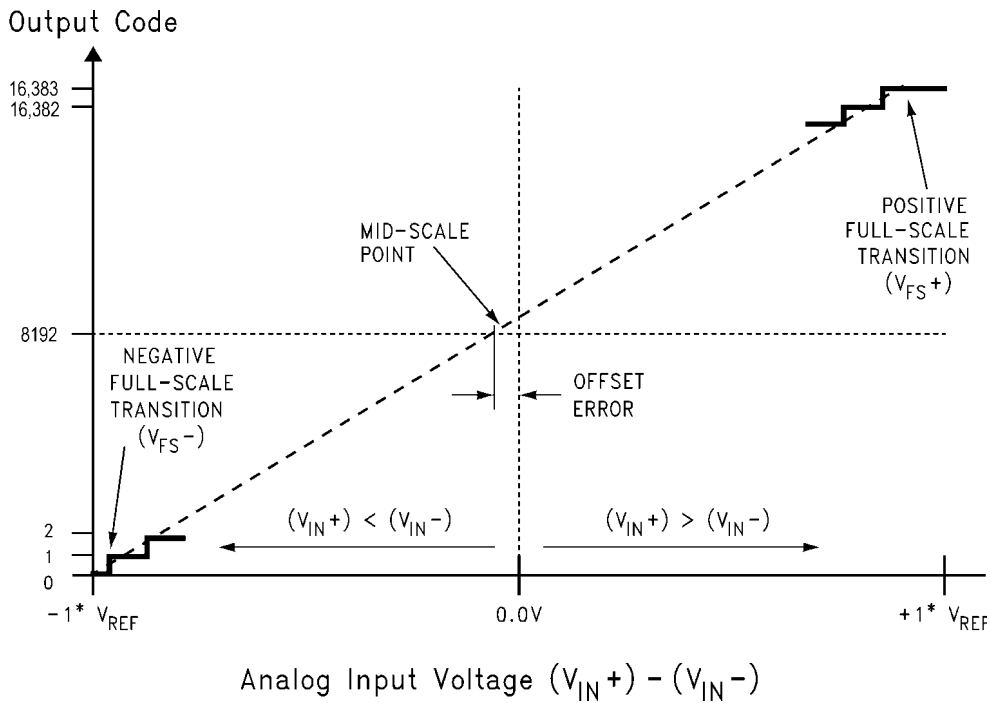

30017910

FIGURE 2. Transfer Characteristic

**Typical Performance Characteristics DNL, INL** Unless otherwise specified, the following specifications apply:  $AGND = DRGND = 0V$ ,  $V_A = +3.3V$ ,  $V_{DR} = +2.5V$ , Internal  $V_{REF} = +1.2V$ ,  $f_{CLK} = 105\text{ MHz}$ , 50% Duty Cycle, DCS disabled,  $V_{CM} = V_{CMO}$ ,  $f_{IN} = 10\text{ MHz}$ ,  $C_L = 5\text{ pF/pin}$ . Typical values are for  $T_A = 25^\circ\text{C}$ .

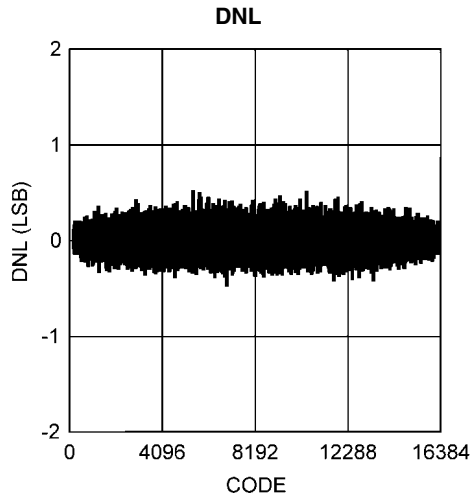

30017941

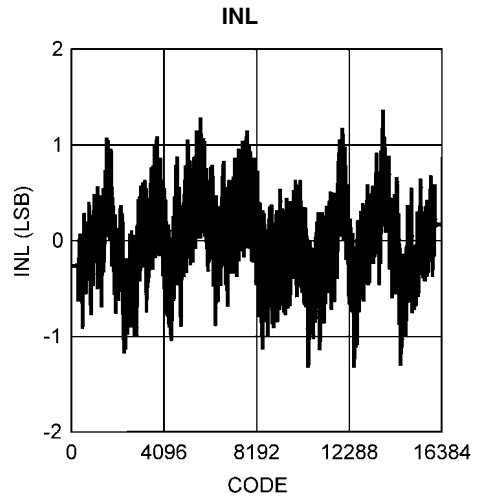

30017942

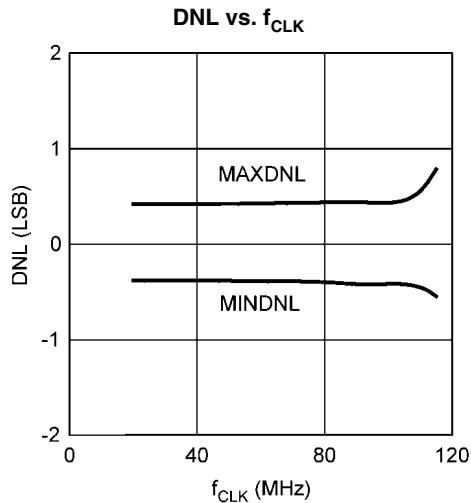

30017943

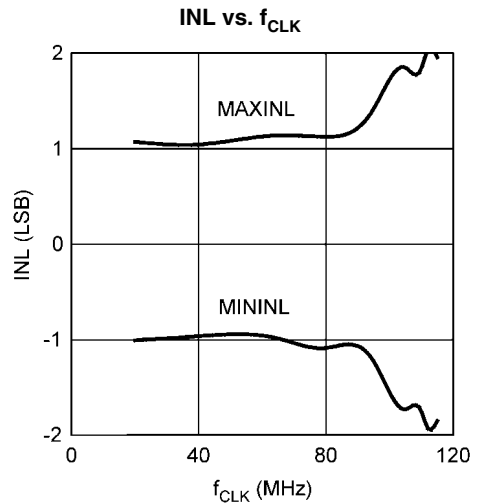

30017944

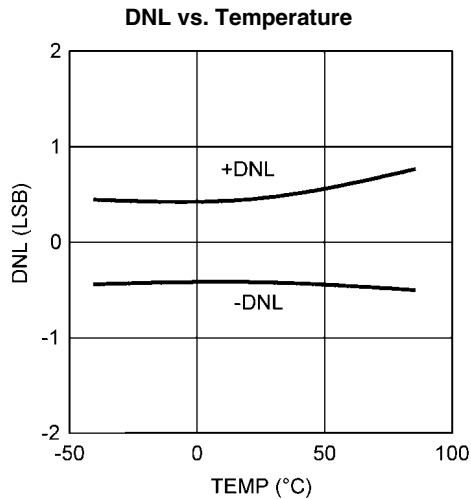

30017947

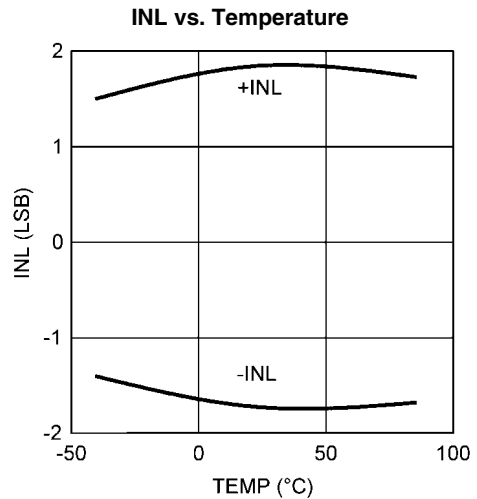

30017948

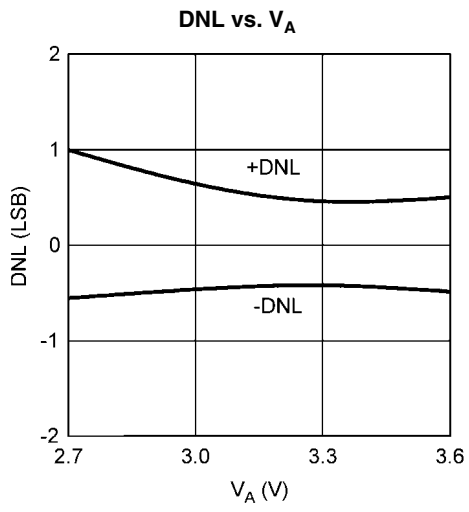

30017949

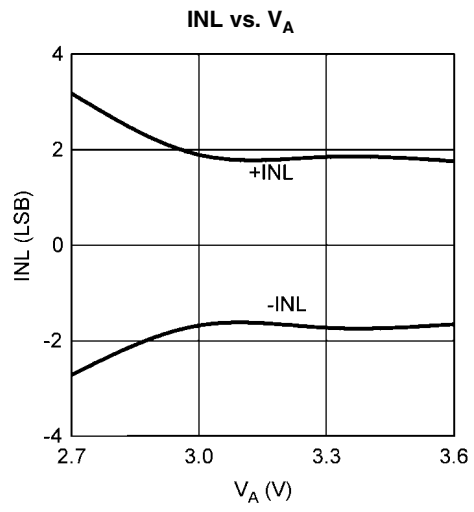

30017950

### Typical Performance Characteristics

Unless otherwise specified, the following specifications apply:

AGND = DRGND = 0V,  $V_A = +3.3V$ ,  $V_{DR} = +2.5V$ , Internal  $V_{REF} = +1.2V$ ,  $f_{CLK} = 105\text{ MHz}$ , 50% Duty Cycle, DCS disabled,  $V_{CM} = V_{CMO}$ ,  $f_{IN} = 10\text{ MHz}$ ,  $C_L = 5\text{ pF/pin}$ . Typical values are for  $T_A = 25^\circ\text{C}$ .

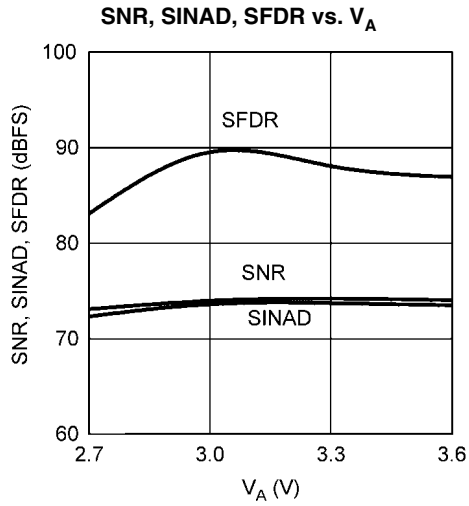

30017951

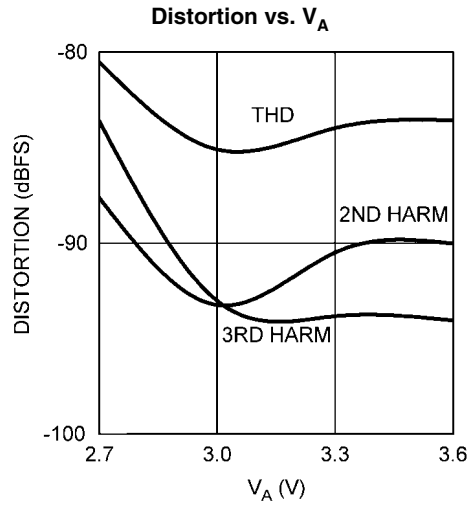

30017952

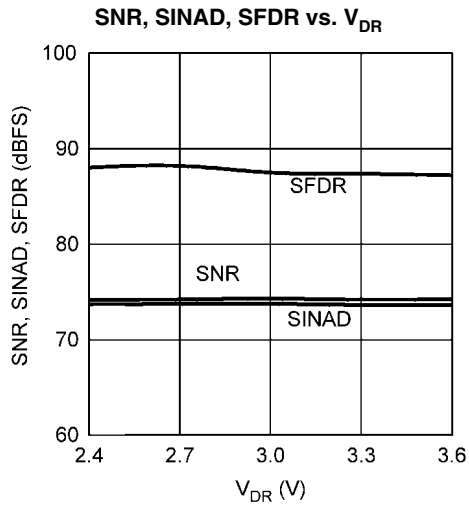

30017953

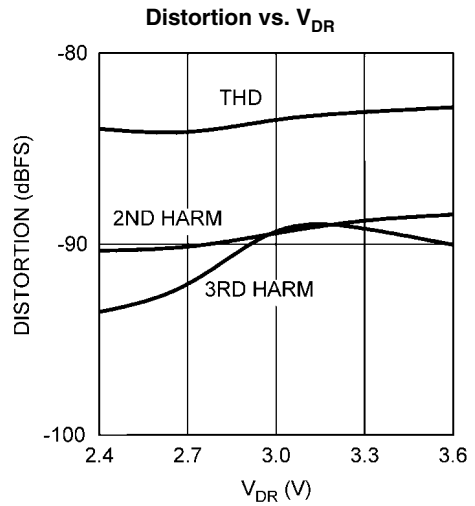

30017954

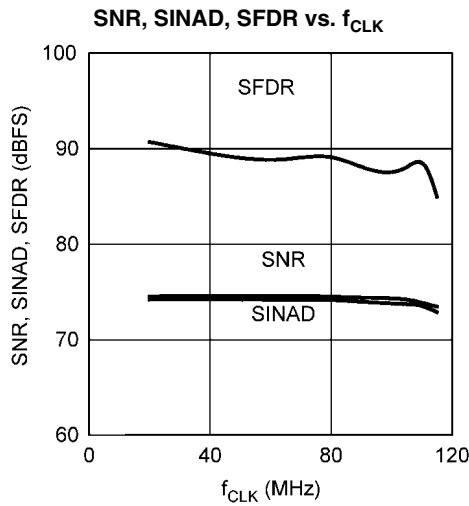

30017955

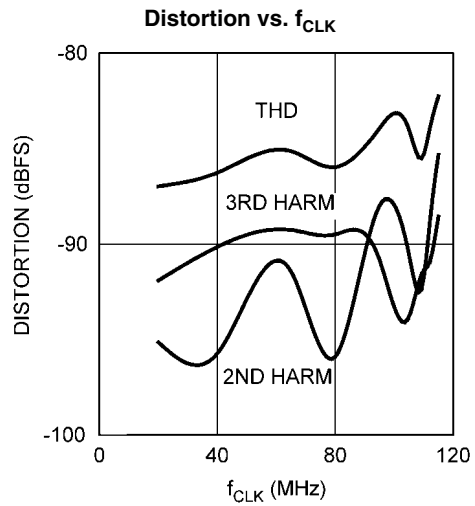

30017956

**SNR, SINAD, SFDR vs. Clock Duty Cycle**

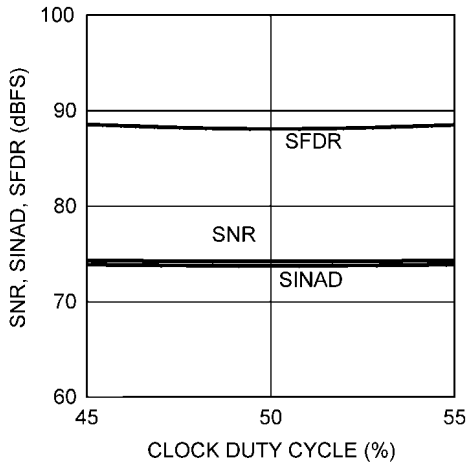

30017957

**Distortion vs. Clock Duty Cycle**

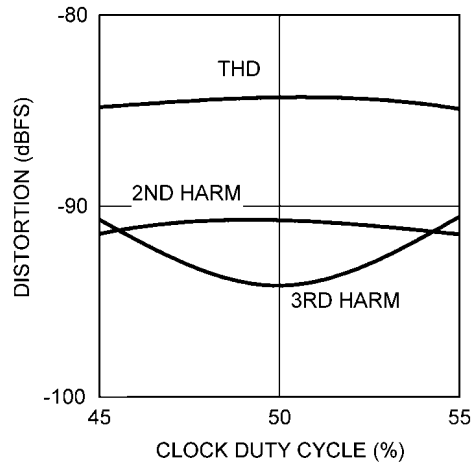

30017958

**SNR, SINAD, SFDR vs. Clock Duty Cycle, DCS Enabled**

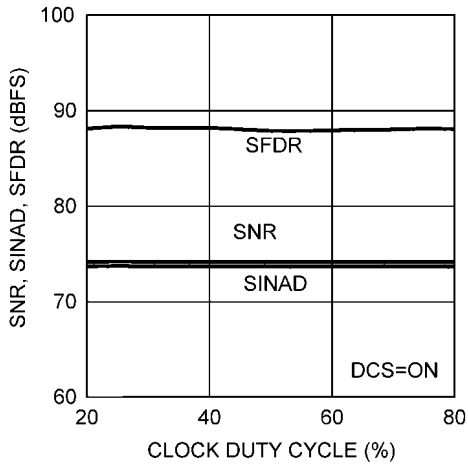

30017959

**Distortion vs. Clock Duty Cycle, DCS Enabled**

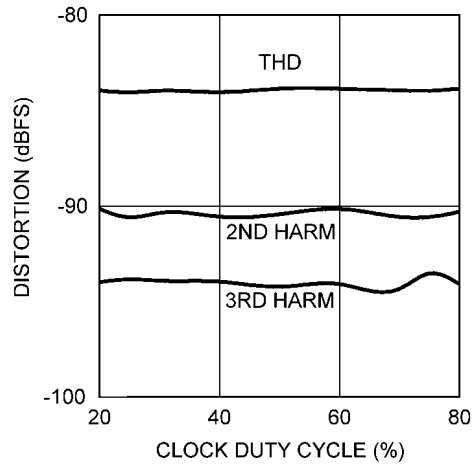

30017960

**SNR, SINAD, SFDR vs.  $f_{IN}$**

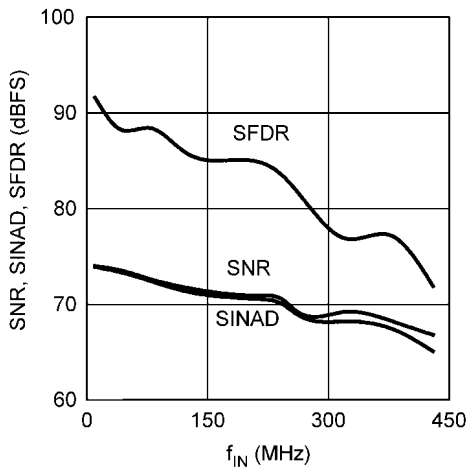

30017963

**Distortion vs.  $f_{IN}$**

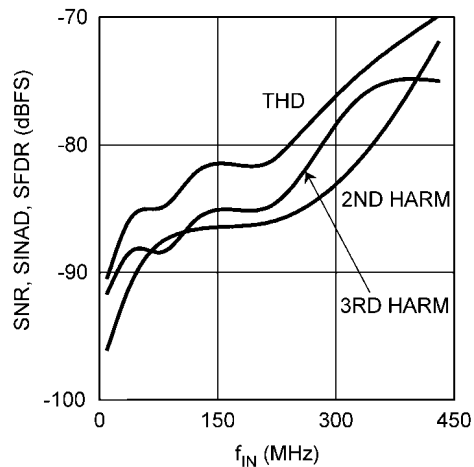

30017964

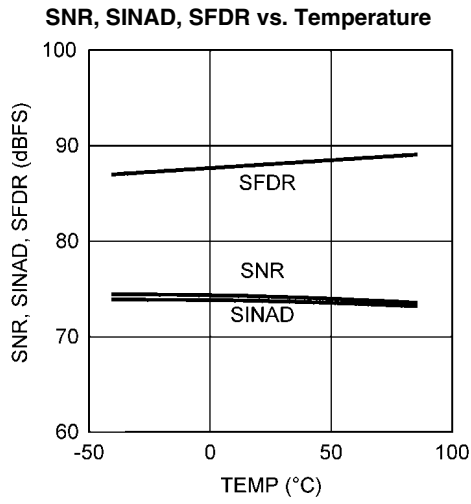

30017965

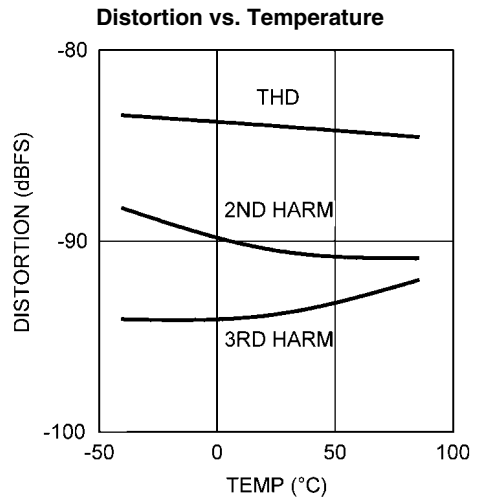

30017966

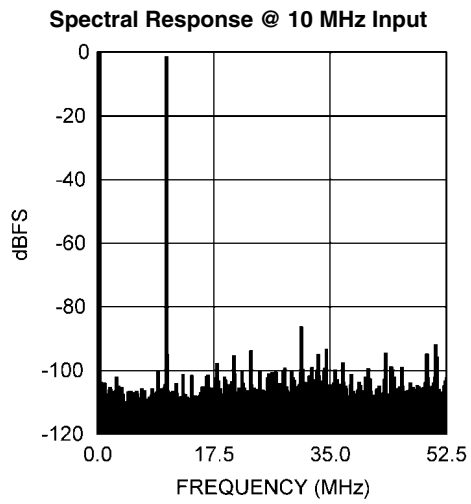

30017968

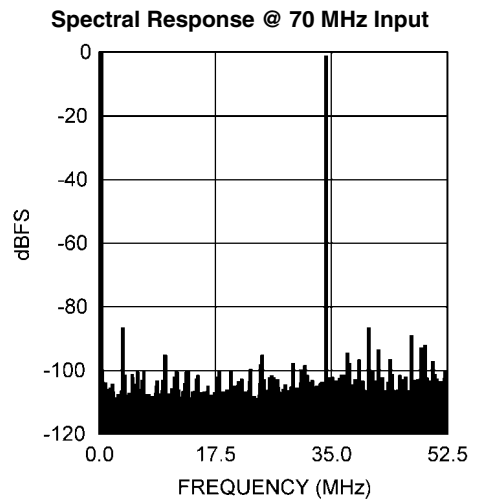

30017969

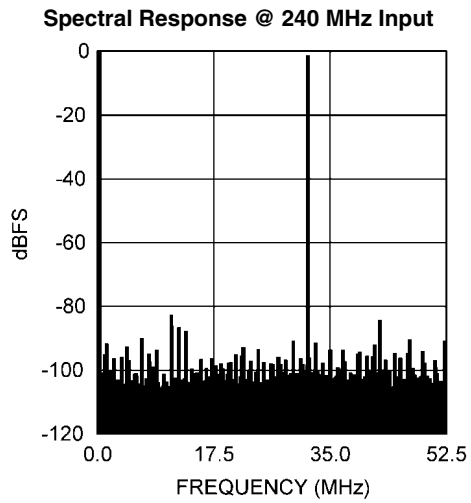

30017970

### Intermodulation Distortion, $f_{IN1} = 19.5 \text{ MHz}$ , $f_{IN2} = 20.5 \text{ MHz}$

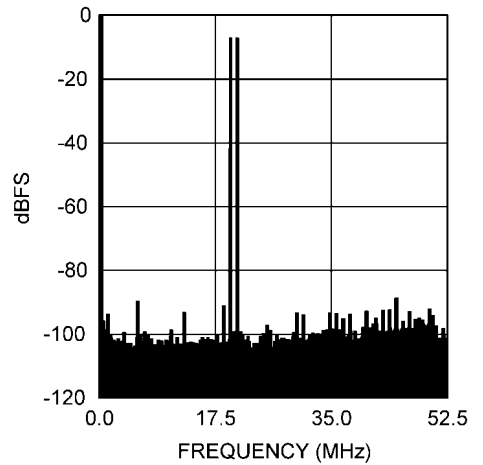

30017971



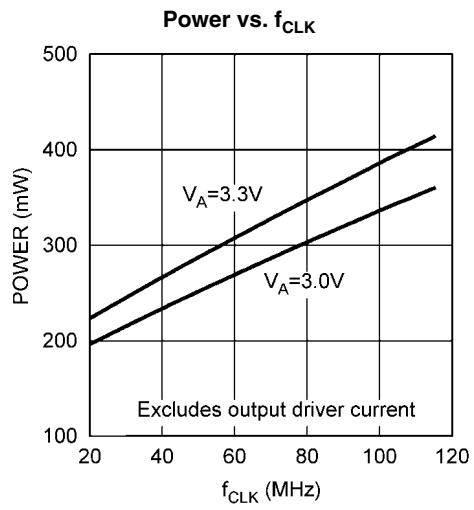

30017972

## Functional Description

Operating on a single +3.3V supply, the ADC14C105 uses a pipeline architecture and has error correction circuitry to help ensure maximum performance. The differential analog input signal is digitized to 14 bits. The user has the choice of using an internal 1.2V stable reference, or using an external 1.2V reference. Any external reference is buffered on-chip to ease the task of driving that pin.

The output word rate is the same as the clock frequency. The analog input is acquired at the rising edge of the clock and the digital data for a given sample is delayed by the pipeline for 7 clock cycles. The digital outputs are CMOS compatible signals that are clocked by a synchronous data ready output signal (DRDY, pin 21) at the same rate as the clock input. Duty cycle stabilization and output data format are selectable using the quad state function OF/DCS pin (pin 12). The output data can be set for offset binary or two's complement.

Power-down is selectable using the PD pin (pin 30). A logic high on the PD pin reduces the converter power consumption. For normal operation, the PD pin should be connected to the analog ground (AGND).

## Applications Information

### 1.0 OPERATING CONDITIONS

We recommend that the following conditions be observed for operation of the ADC14C105:

$$2.7V \leq V_A \leq 3.6V$$

$$2.4V \leq V_{DR} \leq V_A$$

$$20 \text{ MHz} \leq f_{CLK} \leq 105 \text{ MHz}$$

1.2V internal reference

$$V_{REF} = 1.2V \text{ (for an external reference)}$$

$$V_{CM} = 1.5V \text{ (from } V_{CMO})$$

### 2.0 ANALOG INPUTS

#### 2.1 Signal Inputs

##### 2.1.1 Differential Analog Input Pins

The ADC14C105 has one pair of analog signal input pins,  $V_{IN+}$  and  $V_{IN-}$ , which form a differential input pair. The input signal,  $V_{IN}$ , is defined as

$$V_{IN} = (V_{IN+}) - (V_{IN-})$$

Figure 3 shows the expected input signal range. Note that the common mode input voltage,  $V_{CM}$ , should be 1.5V. Using  $V_{CMO}$  (pin 32) for  $V_{CM}$  will ensure the proper input common mode level for the analog input signal. The positive peaks of the individual input signals should each never exceed 2.6V. Each analog input pin of the differential pair should have a

maximum peak-to-peak voltage of 1V, be 180° out of phase with each other and be centered around  $V_{CM}$ . The peak-to-peak voltage swing at each analog input pin should not exceed the 1V or the output data will be clipped.

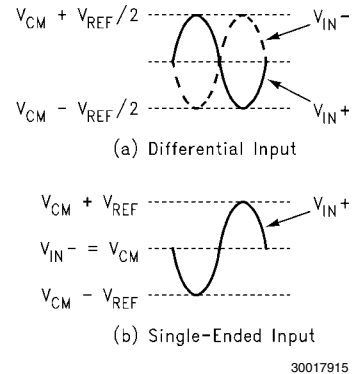

FIGURE 3. Expected Input Signal Range

For single frequency sine waves the full scale error in LSB can be described as approximately

$$E_{FS} = 16384 (1 - \sin(90^\circ + dev))$$

Where dev is the angular difference in degrees between the two signals having a 180° relative phase relationship to each other (see Figure 4). For single frequency inputs, angular errors result in a reduction of the effective full scale input. For complex waveforms, however, angular errors will result in distortion.

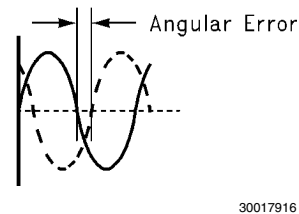

FIGURE 4. Angular Errors Between the Two Input Signals Will Reduce the Output Level or Cause Distortion

It is recommended to drive the analog inputs with a source impedance less than 100Ω. Matching the source impedance for the differential inputs will improve even ordered harmonic performance (particularly second harmonic).

Table 1 indicates the input to output relationship of the ADC14C105.

TABLE 1. Input to Output Relationship

$V_{IN+}$	$V_{IN-}$	Binary Output	2's Complement Output	
$V_{CM} - V_{REF}/2$	$V_{CM} + V_{REF}/2$	00 0000 0000 0000	10 0000 0000 0000	Negative Full-Scale
$V_{CM} - V_{REF}/4$	$V_{CM} + V_{REF}/4$	01 0000 0000 0000	11 0000 0000 0000	
$V_{CM}$	$V_{CM}$	10 0000 0000 0000	00 0000 0000 0000	Mid-Scale
$V_{CM} + V_{REF}/4$	$V_{CM} - V_{REF}/4$	11 0000 0000 0000	01 0000 0000 0000	
$V_{CM} + V_{REF}/2$	$V_{CM} - V_{REF}/2$	11 1111 1111 1111	01 1111 1111 1111	Positive Full-Scale

### 2.1.2 Driving the Analog Inputs

The  $V_{IN+}$  and the  $V_{IN-}$  inputs of the ADC14C105 have an internal sample-and-hold circuit which consists of an analog switch followed by a switched-capacitor amplifier.

Figure 5 and Figure 6 show examples of single-ended to differential conversion circuits. The circuit in Figure 5 works well for input frequencies up to approximately 70MHz, while the circuit in Figure 6 works well above 70MHz.

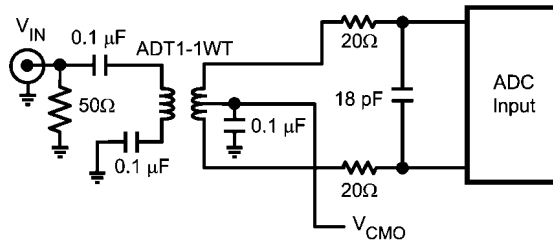

30017920

FIGURE 5. Low Input Frequency Transformer Drive Circuit

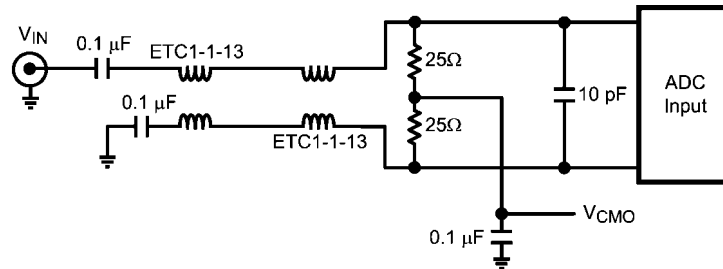

30017921

FIGURE 6. High Input Frequency Transformer Drive Circuit

One short-coming of using a transformer to achieve the single-ended to differential conversion is that most RF transformers have poor low frequency performance. A differential amplifier can be used to drive the analog inputs for low frequency applications. The amplifier must be fast enough to settle from the charging glitches on the analog input resulting from the sample-and-hold operation before the clock goes high and the sample is passed to the ADC core.

The SFDR performance of the converter depends on the external signal conditioning circuitry used, as this affects how quickly the sample-and-hold charging glitch will settle. An external resistor and capacitor network as shown in Figure 7 should be used to isolate the charging glitches at the ADC input from the external driving circuit and to filter the wideband noise at the converter input. These components should be placed close to the ADC inputs because the analog input of the ADC is the most sensitive part of the system, and this is the last opportunity to filter that input. For Nyquist applications the RC pole should be at the ADC sample rate. The ADC input capacitance in the sample mode should be considered when setting the RC pole. For wideband undersampling applica-

tions, the RC pole should be set at least 1.5 to 2 times the maximum input frequency to maintain a linear delay response.

### 2.1.3 Input Common Mode Voltage

The input common mode voltage,  $V_{CM}$ , should be in the range of 1.4V to 1.6V and be a value such that the peak excursions of the analog signal do not go more negative than ground or more positive than 2.6V. It is recommended to use  $V_{CMO}$  (pin 32) as the input common mode voltage.

If the ADC14C105 is operated with  $V_A=3.6V$ , a resistor of approximately 1KΩ should be used from the  $V_{CMO}$  pin to AGND. This will help maintain stability over the entire temperature range when using a high supply voltage.

### 2.2 Reference Pins

The ADC14C105 is designed to operate with an internal or external 1.2V reference. The internal 1.2 Volt reference is the default condition when no external reference input is applied to the  $V_{REF}$  pin. If a voltage is applied to the  $V_{REF}$  pin, then that voltage is used for the reference. The  $V_{REF}$  pin should

always be bypassed to ground with a 0.1  $\mu\text{F}$  capacitor close to the reference input pin.

It is important that all grounds associated with the reference voltage and the analog input signal make connection to the ground plane at a single, quiet point to minimize the effects of noise currents in the ground path.

The Reference Bypass Pins ( $V_{\text{RP}}$ ,  $V_{\text{CMO}}$ , and  $V_{\text{RN}}$ ) are made available for bypass purposes. These pins should each be bypassed to AGND with a low ESL (equivalent series inductance) 1  $\mu\text{F}$  capacitor placed very close to the pin to minimize stray inductance. A 0.1  $\mu\text{F}$  capacitor should be placed between  $V_{\text{RP}}$  and  $V_{\text{RN}}$  as close to the pins as possible, and a 1  $\mu\text{F}$  capacitor should be placed in parallel. This configuration is shown in *Figure 7*. It is necessary to avoid reference oscillation, which could result in reduced SFDR and/or SNR.  $V_{\text{CMO}}$  may be loaded to 1mA for use as a temperature stable 1.5V reference. The remaining pins should not be loaded.

Smaller capacitor values than those specified will allow faster recovery from the power down mode, but may result in degraded noise performance. Loading any of these pins, other than  $V_{\text{CMO}}$  may result in performance degradation.

The nominal voltages for the reference bypass pins are as follows:

$$V_{\text{CMO}} = 1.5 \text{ V}$$

$$V_{\text{RP}} = 2.0 \text{ V}$$

$$V_{\text{RN}} = 1.0 \text{ V}$$

### 2.3 OF/DCS Pin

Duty cycle stabilization and output data format are selectable using this quad state function pin. When enabled, duty cycle stabilization can compensate for clock inputs with duty cycles ranging from 30% to 70% and generate a stable internal clock, improving the performance of the part. With OF/DCS =  $V_{\text{A}}$  the output data format is 2's complement and duty cycle stabilization is not used. With OF/DCS = AGND the output data format is offset binary and duty cycle stabilization is not used. With OF/DCS =  $(2/3)V_{\text{A}}$  the output data format is 2's complement and duty cycle stabilization is applied to the clock. If OF/DCS is  $(1/3)V_{\text{A}}$  the output data format is offset binary and duty cycle stabilization is applied to the clock. While the sense of this pin may be changed "on the fly," doing this is not recommended as the output data could be erroneous for a few clock cycles after this change is made.

## 3.0 DIGITAL INPUTS

Digital CMOS compatible inputs consist of CLK, and PD.

### 3.1 Clock Input

The CLK controls the timing of the sampling process. To achieve the optimum noise performance, the clock input should be driven with a stable, low jitter clock signal in the range indicated in the Electrical Table. The clock input signal should also have a short transition region. This can be achieved by passing a low-jitter sinusoidal clock source through a high speed buffer gate. This configuration is shown in *Figure 7*. The trace carrying the clock signal should be as short as possible and should not cross any other signal line, analog or digital, not even at 90°. *Figure 7* shows the recommended clock input circuit.

The clock signal also drives an internal state machine. If the clock is interrupted, or its frequency is too low, the charge on the internal capacitors can dissipate to the point where the accuracy of the output data will degrade. This is what limits the minimum sample rate.

The clock line should be terminated at its source in the characteristic impedance of that line. Take care to maintain a constant clock line impedance throughout the length of the line. Refer to Application Note AN-905 for information on setting characteristic impedance.

It is highly desirable that the the source driving the ADC clock pins only drive that pin. However, if that source is used to drive other devices, then each driven pin should be AC terminated with a series RC to ground, such that the resistor value is equal to the characteristic impedance of the clock line and the capacitor value is

$$C \geq \frac{4 \times t_{\text{PD}} \times L}{Z_0}$$

where  $t_{\text{PD}}$  is the signal propagation rate down the clock line, "L" is the line length and  $Z_0$  is the characteristic impedance of the clock line. This termination should be as close as possible to the ADC clock pin but beyond it as seen from the clock source. Typical  $t_{\text{PD}}$  is about 150 ps/inch (60 ps/cm) on FR-4 board material. The units of "L" and  $t_{\text{PD}}$  should be the same (inches or centimeters).

The duty cycle of the clock signal can affect the performance of the A/D Converter. Because achieving a precise duty cycle is difficult, the ADC14C105 has a Duty Cycle Stabilizer. It is designed to maintain performance over a clock duty cycle range of 30% to 70%.

### 3.2 Power-Down (PD)

The PD pin, when high, holds the ADC14C105 in a power-down mode to conserve power when the converter is not being used. The power consumption in this state is 5 mW if the clock is stopped when PD is high. The output data pins are undefined and the data in the pipeline is corrupted while in the power down mode.

The Power Down Mode Exit Cycle time is determined by the value of the components on pins 1, 2, and 32 and is about 3 ms with the recommended components on the  $V_{\text{RP}}$ ,  $V_{\text{CMO}}$  and  $V_{\text{RN}}$  reference bypass pins. These capacitors lose their charge in the Power Down mode and must be recharged by on-chip circuitry before conversions can be accurate. Smaller capacitor values allow slightly faster recovery from the power down mode, but can result in a reduction in SNR, SINAD and ENOB performance.

## 4.0 DIGITAL OUTPUTS

Digital outputs consist of the CMOS signals D0-D13, and DRDY.

The ADC14C105 has 15 CMOS compatible data output pins corresponding to the converted input value and a data ready (DRDY) signal that should be used to capture the output data. Valid data is present at these outputs while the PD pin is low. Data should be captured and latched with the rising edge of the DRDY signal.

Be very careful when driving a high capacitance bus. The more capacitance the output drivers must charge for each conversion, the more instantaneous digital current flows through  $V_{\text{DR}}$  and DRGND. These large charging current spikes can cause on-chip ground noise and couple into the analog circuitry, degrading dynamic performance. Adequate bypassing, limiting output capacitance and careful attention to the ground plane will reduce this problem. The result could be an apparent reduction in dynamic performance.

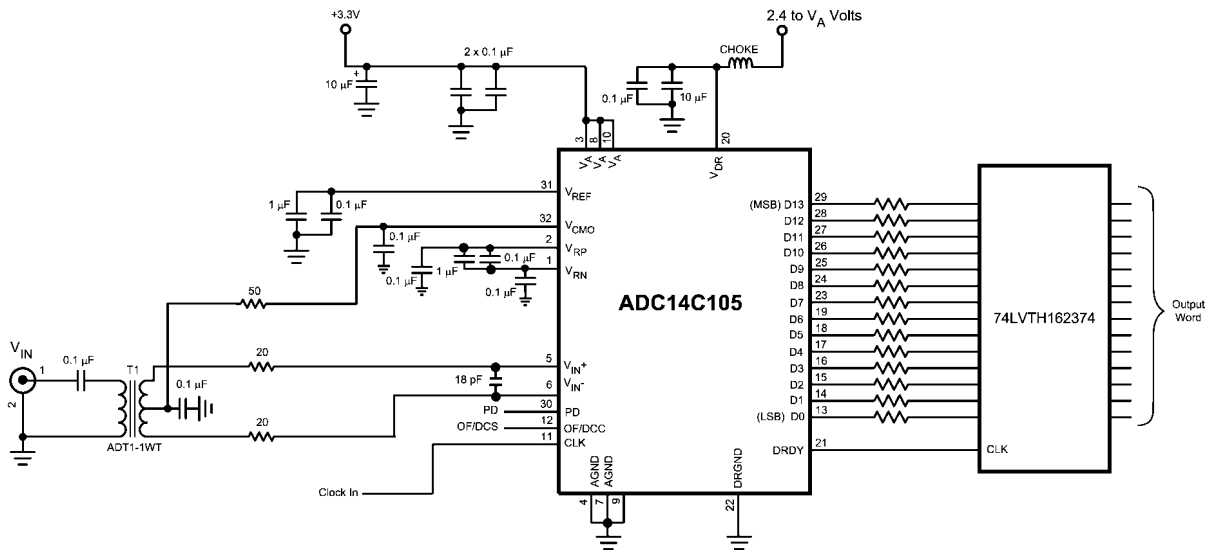

30017919

FIGURE 7. Application Circuit

### 5.0 POWER SUPPLY CONSIDERATIONS

The power supply pins should be bypassed with a 0.1  $\mu\text{F}$  capacitor and with a 100 pF ceramic chip capacitor close to each power pin. Leadless chip capacitors are preferred because they have low series inductance.

As is the case with all high-speed converters, the ADC14C105 is sensitive to power supply noise. Accordingly, the noise on the analog supply pin should be kept below 100 mV<sub>P-P</sub>.

No pin should ever have a voltage on it that is in excess of the supply voltages, not even on a transient basis. Be especially careful of this during power turn on and turn off.

The  $V_{DR}$  pin provides power for the output drivers and may be operated from a supply in the range of 2.4V to  $V_A$ . This enables lower power operation, reduces the noise coupling effects from the digital outputs to the analog circuitry and simplifies interfacing to lower voltage devices and systems.

### 6.0 LAYOUT AND GROUNDING

Proper grounding and proper routing of all signals are essential to ensure accurate conversion. Maintaining separate analog and digital areas of the board, with the ADC14C105 between these areas, is required to achieve specified performance.

The ground return for the data outputs (DRGND) carries the ground current for the output drivers. The output current can exhibit high transients that could add noise to the conversion process. To prevent this from happening, the DRGND pins should NOT be connected to system ground in close proximity to any of the ADC14C105's other ground pins.

Capacitive coupling between the typically noisy digital circuitry and the sensitive analog circuitry can lead to poor performance. The solution is to keep the analog circuitry separated from the digital circuitry, and to keep the clock line as short as possible.

The effects of the noise generated from the ADC output switching can be minimized through the use of 22  $\Omega$  resistors in series with each data output line. Locate these resistors as close to the ADC output pins as possible.

Since digital switching transients are composed largely of high frequency components, total ground plane copper weight will have little effect upon the logic-generated noise. This is because of the skin effect. Total surface area is more important than is total ground plane area.

Generally, analog and digital lines should cross each other at 90° to avoid crosstalk. To maximize accuracy in high speed, high resolution systems, however, avoid crossing analog and digital lines altogether. It is important to keep clock lines as short as possible and isolated from ALL other lines, including other digital lines. Even the generally accepted 90° crossing should be avoided with the clock line as even a little coupling can cause problems at high frequencies. This is because other lines can introduce jitter into the clock line, which can lead to degradation of SNR. Also, the high speed clock can introduce noise into the analog chain.

Best performance at high frequencies and at high resolution is obtained with a straight signal path. That is, the signal path through all components should form a straight line wherever possible.

Be especially careful with the layout of inductors and transformers. Mutual inductance can change the characteristics of the circuit in which they are used. Inductors and transformers should *not* be placed side by side, even with just a small part of their bodies beside each other. For instance, place transformers for the analog input and the clock input at 90° to one another to avoid magnetic coupling.

The analog input should be isolated from noisy signal traces to avoid coupling of spurious signals into the input. Any external component (e.g., a filter capacitor) connected between the converter's input pins and ground or to the reference input pin and ground should be connected to a very clean point in the ground plane.

All analog circuitry (input amplifiers, filters, reference components, etc.) should be placed in the analog area of the board. All digital circuitry and dynamic I/O lines should be placed in the digital area of the board. The ADC14C105 should be between these two areas. Furthermore, all components in the reference circuitry and the input signal chain that are connected to ground should be connected together with short

traces and enter the ground plane at a single, quiet point. All ground connections should have a low inductance path to ground.

### 7.0 DYNAMIC PERFORMANCE

To achieve the best dynamic performance, the clock source driving the CLK input must have a sharp transition region and be free of jitter. Isolate the ADC clock from any digital circuitry with buffers, as with the clock tree shown in *Figure 8*. The gates used in the clock tree must be capable of operating at frequencies much higher than those used if added jitter is to be prevented.

As mentioned in Section 6.0, it is good practice to keep the ADC clock line as short as possible and to keep it well away from any other signals. Other signals can introduce jitter into the clock signal, which can lead to reduced SNR performance, and the clock can introduce noise into other lines. Even lines with 90° crossings have capacitive coupling, so try to avoid even these 90° crossings of the clock line.

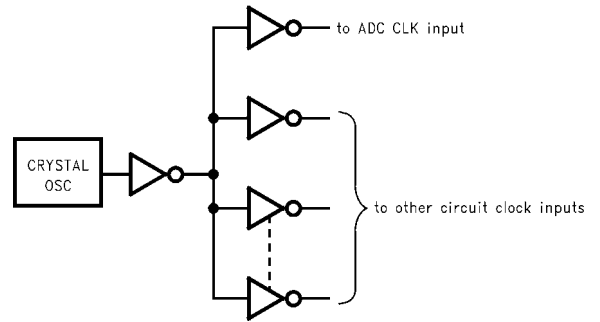

30017917

**FIGURE 8. Isolating the ADC Clock from other Circuitry with a Clock Tree**

**Physical Dimensions** inches (millimeters) unless otherwise noted

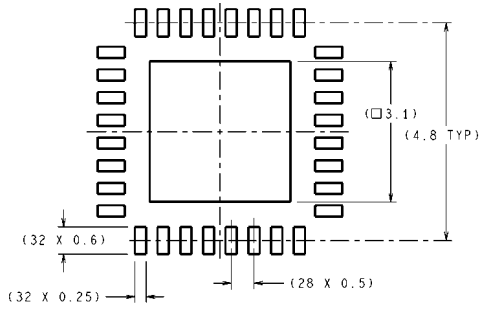

**DIMENSIONS ARE IN MILLIMETERS**  
DIMENSIONS IN ( ) FOR REFERENCE ONLY

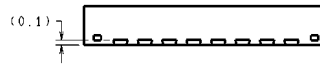

**RECOMMENDED LAND PATTERN**

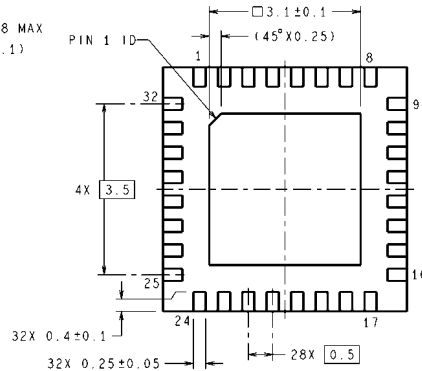
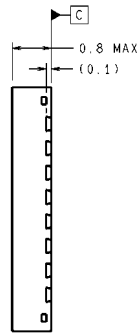
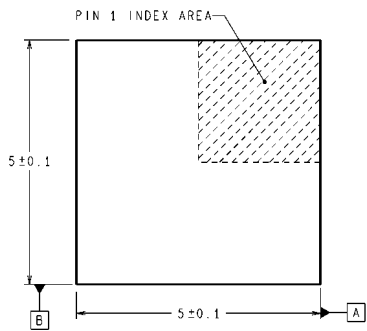

SQA32A (Rev A)

**32-Lead LLP Package**  
**Ordering Number:**  
**ADC14C105CISQ**  
**NS Package Number SQA32A**

## Notes

THE CONTENTS OF THIS DOCUMENT ARE PROVIDED IN CONNECTION WITH NATIONAL SEMICONDUCTOR CORPORATION ("NATIONAL") PRODUCTS. NATIONAL MAKES NO REPRESENTATIONS OR WARRANTIES WITH RESPECT TO THE ACCURACY OR COMPLETENESS OF THE CONTENTS OF THIS PUBLICATION AND RESERVES THE RIGHT TO MAKE CHANGES TO SPECIFICATIONS AND PRODUCT DESCRIPTIONS AT ANY TIME WITHOUT NOTICE. NO LICENSE, WHETHER EXPRESS, IMPLIED, ARISING BY ESTOPPEL OR OTHERWISE, TO ANY INTELLECTUAL PROPERTY RIGHTS IS GRANTED BY THIS DOCUMENT.

TESTING AND OTHER QUALITY CONTROLS ARE USED TO THE EXTENT NATIONAL DEEMS NECESSARY TO SUPPORT NATIONAL'S PRODUCT WARRANTY. EXCEPT WHERE MANDATED BY GOVERNMENT REQUIREMENTS, TESTING OF ALL PARAMETERS OF EACH PRODUCT IS NOT NECESSARILY PERFORMED. NATIONAL ASSUMES NO LIABILITY FOR APPLICATIONS ASSISTANCE OR BUYER PRODUCT DESIGN. BUYERS ARE RESPONSIBLE FOR THEIR PRODUCTS AND APPLICATIONS USING NATIONAL COMPONENTS. PRIOR TO USING OR DISTRIBUTING ANY PRODUCTS THAT INCLUDE NATIONAL COMPONENTS, BUYERS SHOULD PROVIDE ADEQUATE DESIGN, TESTING AND OPERATING SAFEGUARDS.

EXCEPT AS PROVIDED IN NATIONAL'S TERMS AND CONDITIONS OF SALE FOR SUCH PRODUCTS, NATIONAL ASSUMES NO LIABILITY WHATSOEVER, AND NATIONAL DISCLAIMS ANY EXPRESS OR IMPLIED WARRANTY RELATING TO THE SALE AND/OR USE OF NATIONAL PRODUCTS INCLUDING LIABILITY OR WARRANTIES RELATING TO FITNESS FOR A PARTICULAR PURPOSE, MERCHANTABILITY, OR INFRINGEMENT OF ANY PATENT, COPYRIGHT OR OTHER INTELLECTUAL PROPERTY RIGHT.

### LIFE SUPPORT POLICY

**NATIONAL'S PRODUCTS ARE NOT AUTHORIZED FOR USE AS CRITICAL COMPONENTS IN LIFE SUPPORT DEVICES OR SYSTEMS WITHOUT THE EXPRESS PRIOR WRITTEN APPROVAL OF THE CHIEF EXECUTIVE OFFICER AND GENERAL COUNSEL OF NATIONAL SEMICONDUCTOR CORPORATION.** As used herein:

Life support devices or systems are devices which (a) are intended for surgical implant into the body, or (b) support or sustain life and whose failure to perform when properly used in accordance with instructions for use provided in the labeling can be reasonably expected to result in a significant injury to the user. A critical component is any component in a life support device or system whose failure to perform can be reasonably expected to cause the failure of the life support device or system or to affect its safety or effectiveness.

National Semiconductor and the National Semiconductor logo are registered trademarks of National Semiconductor Corporation. All other brand or product names may be trademarks or registered trademarks of their respective holders.

Copyright© 2007 National Semiconductor Corporation

For the most current product information visit us at [www.national.com](http://www.national.com)



**National Semiconductor  
Americas Customer  
Support Center**  
Email:  
[new.feedback@nsc.com](mailto:new.feedback@nsc.com)  
Tel: 1-800-272-9959

**National Semiconductor Europe  
Customer Support Center**  
Fax: +49 (0) 180-530-85-86  
Email: [europe.support@nsc.com](mailto:europe.support@nsc.com)  
Deutsch Tel: +49 (0) 69 9508 6208  
English Tel: +49 (0) 870 24 0 2171  
Français Tel: +33 (0) 1 41 91 8790

**National Semiconductor Asia  
Pacific Customer Support Center**  
Email: [ap.support@nsc.com](mailto:ap.support@nsc.com)

**National Semiconductor Japan  
Customer Support Center**  
Fax: 81-3-5639-7507  
Email: [jpn.feedback@nsc.com](mailto:jpn.feedback@nsc.com)  
Tel: 81-3-5639-7560