

### FEATURES

SNR = 65 dB @  $f_{IN} = 70$  MHz @ 210 MSPS

ENOB of 10.6 @  $f_{IN} = 70$  MHz @ 210 MSPS (-0.5 dBFS)

SFDR = 80 dBc @  $f_{IN} = 70$  MHz @ 210 MSPS (-0.5 dBFS)

Excellent linearity:

DNL =  $\pm 0.3$  LSB (typical)

INL =  $\pm 0.5$  LSB (typical)

2 output data options:

Demultiplexed 3.3 V CMOS outputs each @ 105 MSPS

Interleaved or parallel data output option

LVDS at 210 MSPS

700 MHz full-power analog bandwidth

On-chip reference and track-and-hold

Power dissipation = 1.3 W typical @ 210 MSPS

1.5 V input voltage range

3.3 V supply operation

Output data format option

Data sync input and data clock output provided

Clock duty cycle stabilizer

### GENERAL DESCRIPTION

The AD9430 is a 12-bit, monolithic, sampling analog-to-digital converter (ADC) optimized for high performance, low power, and ease of use. The product operates up to a 210 MSPS conversion rate and is optimized for outstanding dynamic performance in wideband carrier and broadband systems. All necessary functions, including a track-and-hold (T/H) and reference, are included on the chip to provide a complete conversion solution.

The ADC requires a 3.3 V power supply and a differential ENCODE clock for full performance operation. The digital outputs are TTL/CMOS or LVDS compatible and support either twos complement or offset binary format. Separate output power supply pins support interfacing with 3.3 V CMOS logic.

Two output buses support demultiplexed data up to 105 MSPS rates in CMOS mode. A data sync input is supported for proper output data port alignment in CMOS mode, and a data clock output is available for proper output data timing. In LVDS mode, the chip provides data at the ENCODE clock rate.

Fabricated on an advanced BiCMOS process, the AD9430 is available in a 100-lead, surface-mount plastic package (100 e-PAD TQFP) specified over the industrial temperature range (-40°C to +85°C).

#### Rev. E

Information furnished by Analog Devices is believed to be accurate and reliable. However, no responsibility is assumed by Analog Devices for its use, nor for any infringements of patents or other rights of third parties that may result from its use. Specifications subject to change without notice. No license is granted by implication or otherwise under any patent or patent rights of Analog Devices. Trademarks and registered trademarks are the property of their respective owners.

### FUNCTIONAL BLOCK DIAGRAM

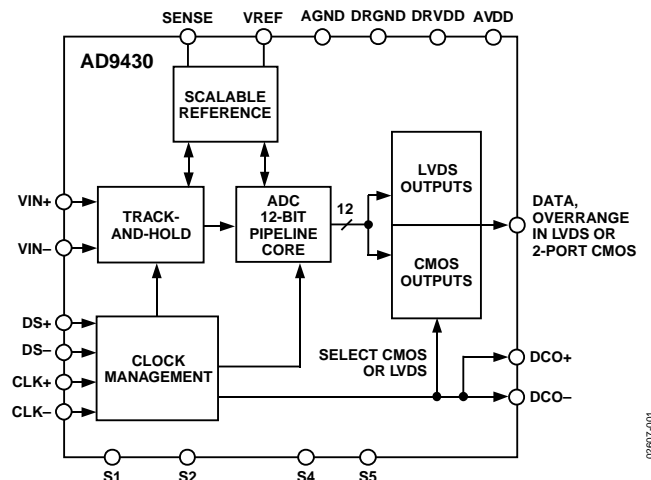

Figure 1.

### APPLICATIONS

Wireless and wired broadband communications

Cable reverse path

Communications test equipment

Radar and satellite subsystems

Power amplifier linearization

### PRODUCT HIGHLIGHTS

- High performance.  
Maintains 65 dB SNR @ 210 MSPS with a 65 MHz input.
- Low power.  
Consumes only 1.3 W @ 210 MSPS.
- Ease of use.  
LVDS output data and output clock signal allow interface to current FPGA technology. The on-chip reference and sample-and-hold provide flexibility in system design. Use of a single 3.3 V supply simplifies system power supply design.
- Out of range (OR) feature.  
The OR output bit indicates when the input signal is beyond the selected input range.
- Pin compatible with 10-bit AD9411 (LVDS only).

**TABLE OF CONTENTS**

DC Specifications .....	4	Analog Inputs .....	28
AC Specifications .....	6	Gain .....	28
Digital Specifications .....	7	ENCODE .....	28
Switching Specifications .....	8	Voltage Reference .....	28
Timing Diagrams .....	9	Data Format Select .....	28
Absolute Maximum Ratings .....	10	I/P Timing Select .....	28
Explanation of Test Levels .....	10	Timing Controls .....	28
ESD Caution .....	10	CMOS Data Outputs .....	29
Pin Configurations and Function Descriptions .....	11	Crystal Oscillator .....	29
Equivalent Circuits .....	15	Optional Amplifier .....	29
Typical Performance Characteristics .....	16	Troubleshooting .....	30
Terminology .....	23	Evaluation Board, LVDS Mode .....	36
Application Notes .....	25	Power Connector .....	36
Theory of Operation .....	25	Analog Inputs .....	36
Encode Input .....	25	Gain .....	36
Analog Input .....	26	Clock .....	36
DS Inputs (DS+, DS-) .....	26	Voltage Reference .....	36
CMOS Outputs .....	26	Data Format Select .....	36
LVDS Outputs .....	27	Data Outputs .....	36
Voltage Reference .....	27	Crystal Oscillator .....	36
Noise Power Ratio Testing (NPR) .....	27	Outline Dimensions .....	42
Evaluation Board, CMOS Mode .....	28	Ordering Guide .....	42
Power Connector .....	28		

**REVISION HISTORY****9/10—Rev. D to Rev. E**

Change to General Description Section.....	1
Change to Operating Temperature Range Parameter, Table 5..	10
Change to Figure 4.....	11
Change to Figure 5.....	13
Added Exposed Pad Notation to Outline Dimensions.....	42

**8/05—Rev. C to Rev. D**

Change to $I_{VREF}$ Spec Units.....	4
Changes to Minimum ENOB Specification.....	6
Added Footnote for Pin 33 in LVDS Mode.....	7
Change to LVDS Output Section.....	27
Added New Evaluation Board, CMOS Mode Section.....	32
Updated Outline Dimensions.....	42

**11/04—Rev. B to Rev. C**

Changes to Specifications.....	4
Changes to Figure 60.....	31
Changes to LVDS PCB BOM.....	35
Changes to Figure 68 (Evaluation Board—LVDS Mode).....	36
Updated Outline Dimensions.....	40

**7/03—Rev. A to Rev. B**

Changed order of Figure 1 and Figure 2.....	5
Updated TPC 13.....	14
Changes to LVDS OUTPUTS section.....	20

## Add New AD9430 EVALUATION BOARD, LVDS MODE

Section.....	27
Updated OUTLINE DIMENSIONS.....	32

**3/03—Rev. 0 to Rev. A**

Upgraded for AD9430-210.....	Universal
Changes to FEATURES.....	1
Changes to PRODUCT HIGHLIGHTS.....	1
Changes to SPECIFICATIONS.....	2
Changes to Figure 2.....	5
Changes to ORDERING GUIDE.....	6
Change to PIN FUNCTION DESCRIPTIONS.....	7
Edits to Output Propagation Delay section.....	10
Added TPCs 5–8, 10–12, 14, 16, 18, 20, 22, 27, 31–32, 34.....	12
Changes to TPCs.....	17, 19, 26, 35–36, 38
Added text to ENCODE INPUT section.....	18
Added DS INPUTS section.....	19
Change to Table I.....	19
Changes to LVDS Outputs section.....	20
Changes to Voltage Reference section.....	20
Replaced Figure 12.....	20
Change to Troubleshooting section.....	22
Updated OUTLINE DIMENSIONS.....	27

**5/02—Revision 0: Initial Version**

# AD9430

## DC SPECIFICATIONS

AVDD = 3.3 V, DRVDD = 3.3 V, T<sub>MIN</sub> = -40°C, T<sub>MAX</sub> = +85°C, f<sub>IN</sub> = -0.5 dBFS, internal reference, full scale = 1.536 V, LVDS output mode, unless otherwise noted.

Table 1.

Parameter	Temp	Test Level	AD9430-170			AD9430-210			Unit
			Min	Typ	Max	Min	Typ	Max	
RESOLUTION				12					Bits
ACCURACY									
No Missing Codes	Full	VI		Guaranteed			Guaranteed		
Offset Error	25°C	I	-3		+3	-3		+3	mV
Gain Error	25°C	I	-5		+5	-5		+5	% FS
Differential Nonlinearity (DNL)	25°C	I	-1	± 0.3	+1	-1	± 0.3	+1	LSB
	Full	VI	-1	± 0.3	+1.5	-1	± 0.3	+1.5	LSB
Integral Nonlinearity (INL)	25°C	I	-1.5	± 0.5	+1.5	-1.75	± 0.3	+1.75	LSB
	Full	VI	-2.25	± 0.5	+2.25	-2.5	± 0.3	+2.5	LSB
TEMPERATURE DRIFT									
Offset Error	Full	V		58			58		μV/°C
Gain Error	Full	V		0.02			0.02		%/°C
Reference Out (VREF)	Full	V		+0.12/-0.24			+0.12/-0.24		mV/°C
REFERENCE									
Reference Out (VREF)	25°C	I	1.15	1.235	1.3	1.15	1.235	1.3	V
Output Current <sup>1</sup>	25°C	IV			3.0			3.0	mA
I <sub>VREF</sub> Input Current <sup>2</sup>	25°C	I			20			20	μA
I <sub>SENSE</sub> Input Current <sup>2</sup>	25°C	I		1.6	5.0		1.6	5.0	mA
ANALOG INPUTS (VIN+, VIN-) <sup>3</sup>									
Differential Input Voltage Range (S5 = GND)	Full	V		1.536			1.536		V
Differential Input Voltage Range (S5 = AVDD)	Full	V		0.766			0.766		V
Input Common-Mode Voltage	Full	VI	2.65	2.8	2.9	2.65	2.8	2.9	V
Input Resistance	Full	VI	2.2	3	3.8	2.2	3	3.8	kΩ
Input Capacitance	25°C	V		5			5		pF
POWER SUPPLY (LVDS Mode)									
AVDD	Full	IV	3.1	3.3	3.6	3.2	3.3	3.6	V
DRVDD	Full	IV	3.0	3.3	3.6	3.0	3.3	3.6	V
Supply Currents									
I <sub>ANALOG</sub> (AVDD = 3.3 V) <sup>4</sup>	Full	VI		335	372		390	450	mA
I <sub>DIGITAL</sub> (DRVDD = 3.3 V) <sup>4</sup>	Full	VI		55	62		55	62	mA
Power Dissipation <sup>4</sup>	Full	VI		1.29	1.43		1.5	1.7	W
Power Supply Rejection	25°C	V		-7.5			-7.5		mV/V

Parameter	Temp	Test Level	AD9430-170			AD9430-210			Unit
			Min	Typ	Max	Min	Typ	Max	
POWER SUPPLY (CMOS Mode)									
AVDD	Full	IV	3.1	3.3	3.6	3.2	3.3	3.6	V
DRVDD	Full	IV	3.0	3.3	3.6	3.0	3.3	3.6	V
Supply Currents									
$I_{AVDD}$ (AVDD = 3.3 V) <sup>5</sup>	Full	IV		335	372		390	450	mA
$I_{DRVDD}$ (DRVDD = 3.3 V) <sup>5</sup>	Full	IV		24	30		30	30	mA
Power Dissipation <sup>5</sup>	Full	IV		1.1			1.3		W
Power Supply Rejection	25°C	V		-7.5			-7.5		mV/V

<sup>1</sup> Internal reference mode; SENSE = Floats.

<sup>2</sup> External reference mode; SENSE = DRVDD, VREF driven by external 1.23 V reference.

<sup>3</sup> S5 (Pin 1) = GND. See the Analog Input section. S5 = GND in all dc and ac tests, unless otherwise noted.

<sup>4</sup>  $I_{AVDD}$  and  $I_{DRVDD}$  are measured with an analog input of 10.3 MHz, -0.5 dBFS, sine wave, rated ENCODE rate, and in LVDS output mode. See Typical Performance Characteristics and Application Notes sections for  $I_{DRVDD}$ . Power consumption is measured with a dc input at rated ENCODE rate in LVDS output mode.

<sup>5</sup>  $I_{AVDD}$  and  $I_{DRVDD}$  are measured with an analog input of 10.3 MHz, -0.5 dBFS, sine wave, rated ENCODE rate, and in CMOS output mode. See Typical Performance Characteristics and Application Notes sections for  $I_{DRVDD}$ . Power consumption is measured with a dc input at rated ENCODE rate in CMOS output mode.

# AD9430

## AC SPECIFICATIONS

AVDD = 3.3 V, DRVDD = 3.3 V, T<sub>MIN</sub> = -40°C, T<sub>MAX</sub> = +85°C, f<sub>IN</sub> = -0.5 dBFS, internal reference, full scale = 1.536 V, LVDS output mode, unless otherwise noted.<sup>1</sup>

Table 2.

Parameter		Temp	Test Level	AD9430-170			AD9430-210			Unit
				Min	Typ	Max	Min	Typ	Max	
SNR Analog Input @ -0.5 dBFS	10 MHz	25°C	I	63.5	65		62.5	64.5		dB
	70 MHz	25°C	I	63	65		62.5	64.5		dB
	100 MHz	25°C	V		65			64.5		dB
	240 MHz	25°C	V		61			61		dB
SINAD Analog Input @ -0.5 dBFS	10 MHz	25°C	I	63.5	65		62.5	64.5		dB
	70 MHz	25°C	I	63	65		62.5	64.5		dB
	100 MHz	25°C	V		65			64.5		dB
	240 MHz	25°C	V		60			60		dB
EFFECTIVE NUMBER OF BITS (ENOB)	10 MHz	25°C	I	10.3	10.6		10.2	10.5		Bits
	70 MHz	25°C	I	10.3	10.6		10.2	10.5		Bits
	100 MHz	25°C	V		10.6			10.5		Bits
	240 MHz	25°C	V		9.8			9.8		Bits
WORST HARMONIC (2nd or 3rd) Analog Input @ -0.5 dBFS, 10 MHz	10 MHz	25°C	I		-85	-75		-84	-74	dBc
	70 MHz	25°C	I		-85	-75		-84	-74	dBc
	100 MHz	25°C	V		-77			-77		dBc
	240 MHz	25°C	V		-63			-63		dBc
WORST HARMONIC (4th or Higher) Analog Input @ -0.5 dBFS, 10 MHz	10 MHz	25°C	I		-87	-78		-87	-77	dBc
	70 MHz	25°C	I		-87	-78		-87	-77	dBc
	100 MHz	25°C	V		-77			-77		dBc
	240 MHz	25°C	V		-63			-63		dBc
TWO-TONE IMD <sup>2</sup> F1, F2 @ -7 dBFS		25°C	V		-75			-75		dBc
ANALOG INPUT BANDWIDTH		25°C	V		700			700		MHz

<sup>1</sup> All ac specifications tested by differentially driving CLK+ and CLK-.

<sup>2</sup> F1 = 28.3 MHz, F2 = 29.3 MHz.

## DIGITAL SPECIFICATIONS

AVDD = 3.3 V, DRVDD = 3.3 V, T<sub>MIN</sub> = -40°C, T<sub>MAX</sub> = +85°C, unless otherwise noted.

Table 3.

Parameter	Temp	Test Level	AD9430-170			AD9430-210			Unit
			Min	Typ	Max	Min	Typ	Max	
ENCODE AND DS INPUTS (CLK+, CLK-, DS+, DS-) <sup>1</sup>									
Differential Input Voltage <sup>2</sup>	Full	IV	0.2			0.2			V
Common-Mode Voltage <sup>3</sup>	Full	VI	1.375	1.5	1.575	1.375	1.5	1.575	V
Input Resistance	Full	VI	3.2	5.5	6.5	3.2	5.5	6.5	kΩ
Input Capacitance	25°C	V		4			4		pF
LOGIC INPUTS (S1, S2, S4, S5)									
Logic 1 Voltage	Full	IV	2.0			2.0			V
Logic 0 Voltage	Full	IV			0.8			0.8	V
Logic 1 Input Current	Full	VI			190			190	μA
Logic 0 Input Current	Full	VI			10			10	μA
Input Resistance	25°C	V		30			30		kΩ
Input Capacitance	25°C	V		4			4		pF
LOGIC OUTPUTS (CMOS Mode)									
Logic 1 Voltage <sup>4</sup>	Full	IV	DRVDD			DRVDD			V
Logic 0 Voltage <sup>4</sup>	Full	IV	-0.05		0.05	-0.05		0.05	V
LOGIC OUTPUTS (LVDS Mode) <sup>4, 5</sup>									
V <sub>OD</sub> Differential Output Voltage	Full	VI	247		454	247		454	mV
V <sub>OS</sub> Output Offset Voltage	Full	VI	1.125		1.375	1.125		1.375	V
Output Coding			Twos complement or binary			Twos complement or binary			

<sup>1</sup> ENCODE (Clock) and DS inputs identical on the chip. See the Equivalent Circuits section.

<sup>2</sup> All ac specifications tested by driving CLK+ and CLK- differentially, |(CLK+) - (CLK-)| > 200 mV.

<sup>3</sup> ENCODE (Clock) inputs' common-mode can be externally set, such that 0.9 V < (CLK+ or CLK-) < 2.6 V.

<sup>4</sup> Digital output logic levels: DRVDD = 3.3 V, C<sub>LOAD</sub> = 5 pF.

<sup>5</sup> LVDS R<sub>TERM</sub> = 100 Ω, LVDS output current set resistor (R<sub>SET</sub>) = 3.74 kΩ (1% tolerance).

## SWITCHING SPECIFICATIONS

AVDD = 3.3 V, DRVDD = 3.3 V, T<sub>MIN</sub> = -40°C, T<sub>MAX</sub> = +85°C, unless otherwise noted.

Table 4.

Parameter (Conditions)	Temp	Test Level	AD9430-170			AD9430-210			Unit
			Min	Typ	Max	Min	Typ	Max	
Maximum Conversion Rate <sup>1</sup>	Full	VI	170			210			MSPS
Minimum Conversion Rate <sup>1</sup>	Full	V			40			40	MSPS
CLK+ Pulse Width High (t <sub>EH</sub> ) <sup>1</sup>	Full	IV	2		12.5	2		12.5	ns
CLK+ Pulse Width Low (t <sub>EL</sub> ) <sup>1</sup>	Full	IV	2		12.5	2		12.5	ns
DS Input Setup Time (t <sub>SDS</sub> ) <sup>2</sup>	Full	IV	-0.5			-0.5			ns
DS Input Hold Time (t <sub>HDS</sub> ) <sup>2</sup>	Full	IV	1.75			1.75			ns
OUTPUT (CMOS Mode)									
Valid Time (t <sub>v</sub> )	Full	IV	2			2			ns
Propagation Delay (t <sub>PD</sub> )	Full	IV		3.8	5		3.8	5	ns
Rise Time (t <sub>r</sub> ) (20% to 80%)	25°C	V		1			1		ns
Fall Time (t <sub>f</sub> ) (20% to 80%)	25°C	V		1			1		ns
DCO Propagation Delay (t <sub>CPD</sub> )	Full	IV		3.8	5		3.8	5	ns
Data to DCO Skew (t <sub>PD</sub> to t <sub>CPD</sub> )	Full	IV	-0.5	0	+0.5	-0.5	0	+0.5	ns
Interleaved Mode (A, B Latency)	Full	IV		14, 14			14, 14		Cycles
Parallel Mode (A, B Latency)	Full	IV		15, 14			15, 14		Cycles
OUTPUT (LVDS Mode)									
Valid Time (t <sub>v</sub> )	Full	VI	2.0			2.0			ns
Propagation Delay (t <sub>PD</sub> )	Full	VI		3.2	4.3		3.2	4.3	ns
Rise Time (t <sub>r</sub> ) (20% to 80%)	25°C	V		0.5			0.5		ns
Fall Time (t <sub>f</sub> ) (20% to 80%)	25°C	V		0.5			0.5		ns
DCO Propagation Delay (t <sub>CPD</sub> )	Full	VI	1.8	2.7	3.8	1.8	2.7	3.8	ns
Data to DCO Skew (t <sub>PD</sub> - t <sub>CPD</sub> )	Full	IV	0.2	0.5	0.8	0.2	0.5	0.8	ns
Latency	Full	IV		14			14		Cycles
APERTURE DELAY (t <sub>A</sub> )	25°C	V		1.2			1.2		ns
APERTURE UNCERTAINTY (Jitter, t <sub>j</sub> )	25°C	V		0.25			0.25		ps rms
OUT OF RANGE RECOVERY TIME (CMOS and LVDS)	25°C	V			1			1	Cycles

<sup>1</sup> All ac specifications tested by differentially driving CLK+ and CLK-.

<sup>2</sup> DS inputs used in CMOS mode only.



TIMING DIAGRAMS

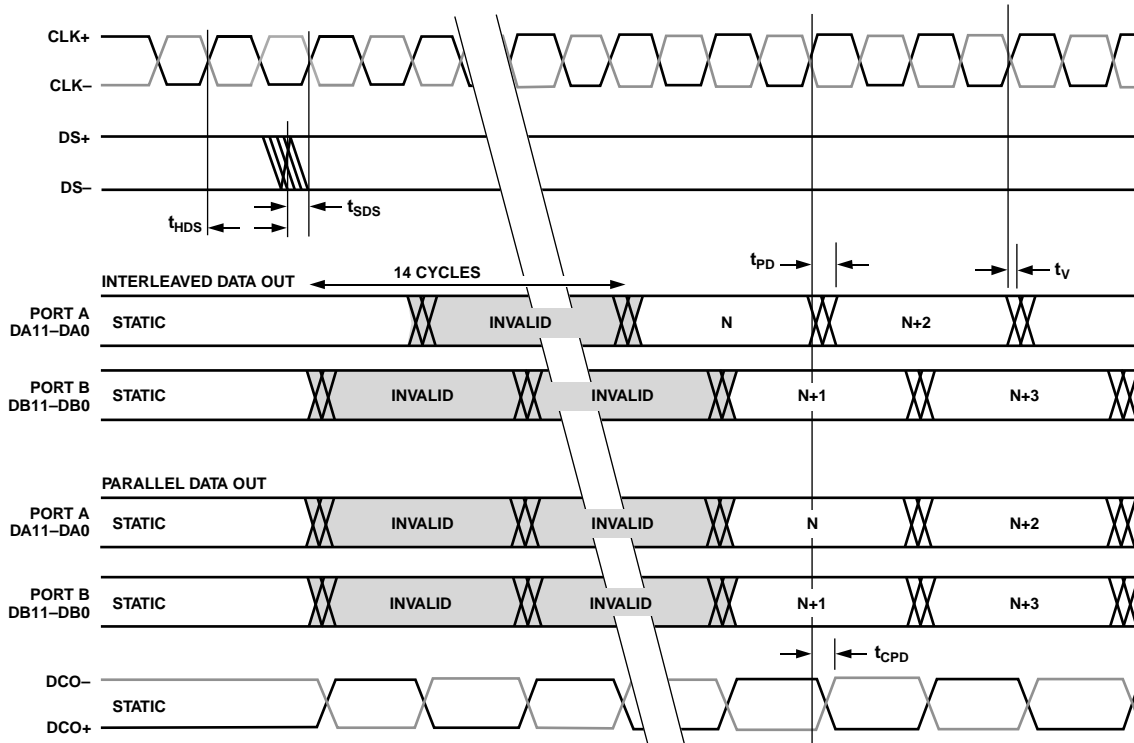

Figure 2. CMOS Timing Diagram

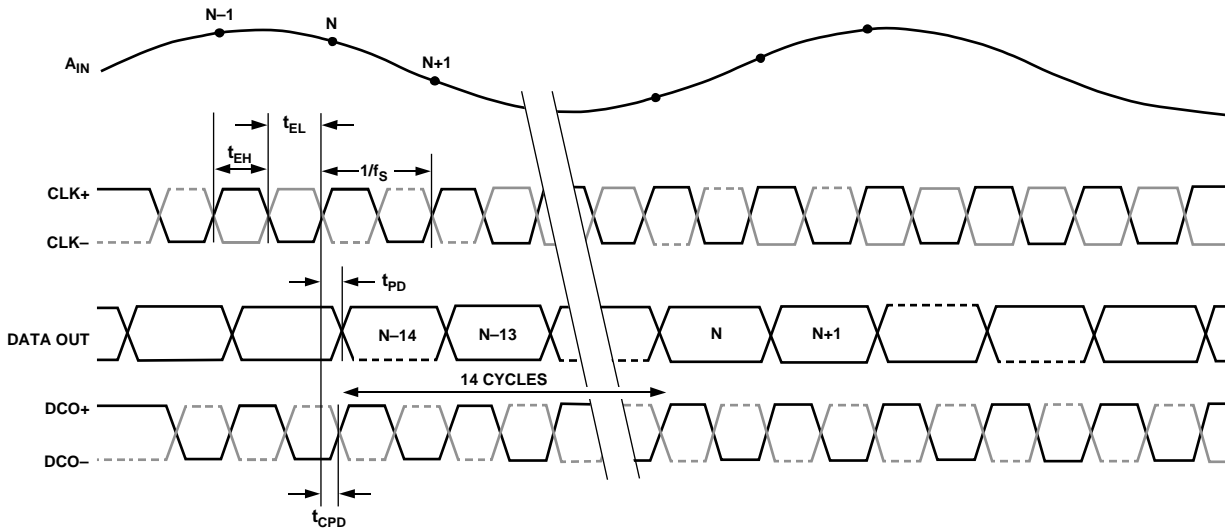

Figure 3. LVDS Timing Diagram

## ABSOLUTE MAXIMUM RATINGS

Table 5.

Parameter	Rating
AVDD, DRVDD	4 V
Analog Inputs	–0.5 V to AVDD + 0.5 V
Digital Inputs	–0.5 V to DRVDD + 0.5 V
REFIN Inputs	–0.5 V to AVDD + 0.5 V
Digital Output Current	20 mA
Operating Temperature Range	–40°C to +85°C
Storage Temperature Range	–65°C to +150°C
Maximum Junction Temperature	150°C
Maximum Case Temperature	150°C
$\theta_{JA}$ <sup>1</sup>	25°C/W, 32°C/W

<sup>1</sup> Typical  $\theta_{JA}$  = 32°C/W (heat slug not soldered); typical  $\theta_{JA}$  = 25°C/W (heat slug soldered) for multilayer board in still air with solid ground plane.

Stresses above those listed under Absolute Maximum Ratings may cause permanent damage to the device. This is a stress rating only; functional operation of the device at these or any other conditions above those listed in the operational section of this specification is not implied. Exposure to absolute maximum rating conditions for extended periods may affect device reliability.

### EXPLANATION OF TEST LEVELS

Table 6.

Level	Description
I	100% production tested.
II	100% production tested at 25°C and sample tested at specified temperatures.
III	Sample tested only.
IV	Parameter is guaranteed by design and characterization testing.
V	Parameter is a typical value only.
VI	100% production tested at 25°C; guaranteed by design and characterization testing for industrial temperature range; 100% production tested at temperature extremes for military devices.

### ESD CAUTION

ESD (electrostatic discharge) sensitive device. Electrostatic charges as high as 4000 V readily accumulate on the human body and test equipment and can discharge without detection. Although this product features proprietary ESD protection circuitry, permanent damage may occur on devices subjected to high energy electrostatic discharges. Therefore, proper ESD precautions are recommended to avoid performance degradation or loss of functionality.



## PIN CONFIGURATIONS AND FUNCTION DESCRIPTIONS

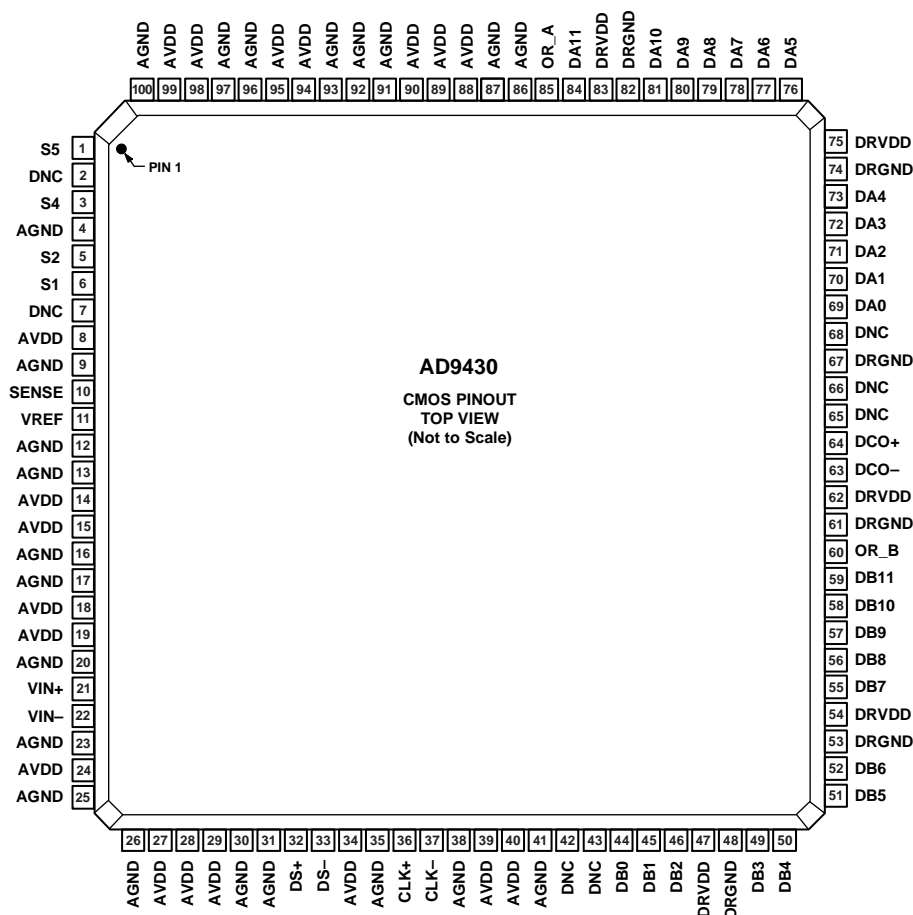

## NOTES

1. THE AD9430 HAS A CONDUCTIVE HEAT SLUG TO HELP DISSIPATE HEAT AND ENSURE RELIABLE OPERATION OF THE DEVICE OVER THE FULL INDUSTRIAL TEMPERATURE RANGE. THE SLUG IS EXPOSED ON THE BOTTOM OF THE PACKAGE AND ELECTRICALLY CONNECTED TO CHIP GROUND. IT IS RECOMMENDED THAT NO PCB SIGNAL TRACES OR VIAS BE LOCATED UNDER THE PACKAGE THAT COULD COME IN CONTACT WITH THE CONDUCTIVE SLUG. ATTACHING THE SLUG TO A GROUND PLANE WILL REDUCE THE JUNCTION TEMPERATURE OF THE DEVICE WHICH MAY BE BENEFICIAL IN HIGH TEMPERATURE ENVIRONMENTS.

0/26107-004

Figure 4. CMOS Dual-Mode Pin Configuration

Table 7. CMOS Mode Pin Function Descriptions

Pin Number	Mnemonic	Description
1	S5	Full-Scale Adjust Pin. AVDD sets $f_s = 0.768$ V p-p differential, GND sets $f_s = 1.536$ V p-p differential.
2, 7, 42, 43, 65, 66, 68	DNC	Do Not Connect.
3	S4	Interleaved, Parallel Select Pin. High = interleaved.
4, 9, 12, 13, 16, 17, 20, 23, 25, 26, 30, 31, 35, 38, 41, 86, 87, 91, 92, 93, 96, 97, 100	AGND <sup>1</sup>	Analog Ground.
5	S2	Output Mode Select. Low = dual-port CMOS, high = LVDS.
6	S1	Data Format Select. Low = binary, high = twos complement for both CMOS and LVDS modes.
8, 14, 15, 18, 19, 24, 27, 28, 29, 34, 39, 40, 88, 89, 90, 94, 95, 98, 99	AVDD	3.3 V Analog Supply.
10	SENSE	Reference Mode Select Pin. Float for internal reference operation.
11	VREF	1.235 V Reference I/O—Function Dependent on SENSE.
21	VIN+	Analog Input—True.
22	VIN-	Analog Input—Complement.
32	DS+	Data Sync (Input)—True. Tie low if not used.
33	DS- <sup>2</sup>	Data Sync (Input)—Complement. Tie high if not used.

# AD9430

Pin Number	Mnemonic	Description
36	CLK+	Clock Input—True.
37	CLK-	Clock Input—Complement.
44	DB0	B Port Output Data Bit (LSB).
45	DB1	B Port Output Data Bit.
46	DB2	B Port Output Data Bit.
47, 54, 62, 75, 83	DRVDD	3.3 V Digital Output Supply (3.0 V to 3.6 V).
48, 53, 61, 67, 74, 82	DRGND <sup>1</sup>	Digital Output Ground.
49	DB3	B Port Output Data Bit.
50	DB4	B Port Output Data Bit.
51	DB5	B Port Output Data Bit.
52	DB6	B Port Output Data Bit.
55	DB7	B Port Output Data Bit.
56	DB8	B Port Output Data Bit.
57	DB9	B Port Output Data Bit.
58	DB10	B Port Output Data Bit.
59	DB11	B Port Output Data Bit (MSB).
60	OR_B	B Port Overrange.
63	DCO-	Data Clock Output—Complement.
64	DCO+	Data Clock Output—True.
69	DA0	A Port Output Data Bit (LSB).
70	DA1	A Port Output Data Bit.
71	DA2	A Port Output Data Bit.
72	DA3	A Port Output Data Bit.
73	DA4	A Port Output Data Bit.
76	DA5	A Port Output Data Bit.
77	DA6	A Port Output Data Bit.
78	DA7	A Port Output Data Bit.
79	DA8	A Port Output Data Bit.
80	DA9	A Port Output Data Bit.
81	DA10	A Port Output Data Bit.
84	DA11	A Port Output Data Bit (MSB).
85	OR_A	A Port Overrange.

<sup>1</sup> AGND and DRGND should be tied together to a common ground plane.

<sup>2</sup> DS Complement (DS-); can be tied to AVDD (as recommended) or left floating with no ill effects.

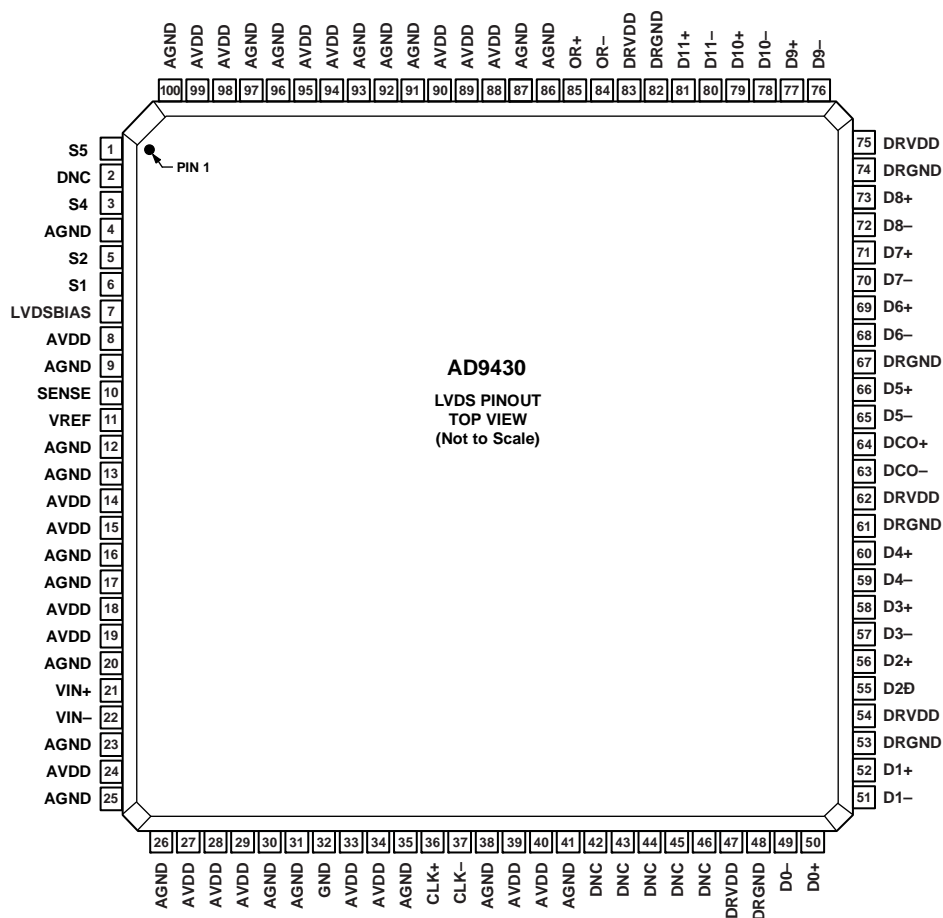

**NOTES**  
 1. THE AD9430 HAS A CONDUCTIVE HEAT SLUG TO HELP DISSIPATE HEAT AND ENSURE RELIABLE OPERATION OF THE DEVICE OVER THE FULL INDUSTRIAL TEMPERATURE RANGE. THE SLUG IS EXPOSED ON THE BOTTOM OF THE PACKAGE AND ELECTRICALLY CONNECTED TO CHIP GROUND. IT IS RECOMMENDED THAT NO PCB SIGNAL TRACES OR VIAS BE LOCATED UNDER THE PACKAGE THAT COULD COME IN CONTACT WITH THE CONDUCTIVE SLUG. ATTACHING THE SLUG TO A GROUND PLANE WILL REDUCE THE JUNCTION TEMPERATURE OF THE DEVICE WHICH MAY BE BENEFICIAL IN HIGH TEMPERATURE ENVIRONMENTS.

Figure 5. LVDS Mode Pin Configuration

02807-905

Table 8. LVDS Mode Pin Function Descriptions

Pin Number	Mnemonic	Description
1	S5	Full-Scale Adjust Pin. AVDD sets $f_s = 0.768$ V p-p differential, GND sets $f_s = 1.536$ V p-p differential.
2, 42 to 46	DNC	Do Not Connect.
3	S4	Control Pin for CMOS Mode. Tie low when operating in LVDS mode.
4, 9, 12, 13, 16, 17, 20, 23, 25, 26, 30, 31, 35, 38, 41, 86, 87, 91, 92, 93, 96, 97, 100	AGND <sup>1</sup>	Analog Ground.
5	S2	Output Mode Select. GND = dual-port CMOS; AVDD = LVDS.
6	S1	Data Format Select. GND = binary, AVDD = twos complement.
7	LVDSBIAS	Set Pin for LVDS Output Current. Place 3.74 kW resistor terminated to ground.
8, 14, 15, 18, 19, 24, 27, 28, 29, 33, 34, 39, 40, 88, 89, 90, 94, 95, 98, 99	AVDD <sup>2</sup>	3.3 V Analog Supply.
10	SENSE	Reference Mode Select Pin. Float for internal reference operation.
11	VREF	1.235 V Reference I/O—Function Dependent on SENSE.
21	VIN+	Analog Input—True.

# AD9430

Pin Number	Mnemonic	Description
22	VIN-	Analog Input—Complement.
32	GND	Data Sync (Input)—Not Used in LVDS Mode. Tie to GND.
36	CLK+	Clock Input—True (LVPECL Levels).
37	CLK-	Clock Input—Complement (LVPECL Levels).
47, 54, 62, 75, 83	DRVDD	3.3 V Digital Output Supply (3.0 V to 3.6 V).
48, 53, 61, 67, 74, 82	DRGND <sup>1</sup>	Digital Output Ground.
49	D0-	D0 Complement Output Bit (LSB).
50	D0+	D0 True Output Bit (LSB).
51	D1-	D1 Complement Output Bit.
52	D1+	D1 True Output Bit.
55	D2-	D2 Complement Output Bit.
56	D2+	D2 True Output Bit.
57	D3-	D3 Complement Output Bit.
58	D3+	D3 True Output Bit.
59	D4-	D4 Complement Output Bit.
60	D4+	D4 True Output Bit.
63	DCO-	Data Clock Output—Complement.
64	DCO+	Data Clock Output—True.
65	D5-	D5 Complement Output Bit.
66	D5+	D5 True Output Bit.
68	D6-	D6 Complement Output Bit.
69	D6+	D6 True Output Bit.
70	D7-	D7 Complement Output Bit.
71	D7+	D7 True Output Bit.
72	D8-	D8 Complement Output Bit.
73	D8+	D8 True Output Bit.
76	D9-	D9 Complement Output Bit.
77	D9+	D9 True Output Bit.
78	D10-	D10 Complement Output Bit.
79	D10+	D10 True Output Bit.
80	D11-	D11 Complement Output Bit.
81	D11+	D11 True Output Bit.
84	OR-	Overrange Complement Output Bit.
85	OR+	Overrange True Output Bit.

<sup>1</sup> AGND and DRGND should be tied together to a common ground plane.

<sup>2</sup> Pin 33 can be tied to AVDD (as recommended) or left floating with no ill effects

EQUIVALENT CIRCUITS

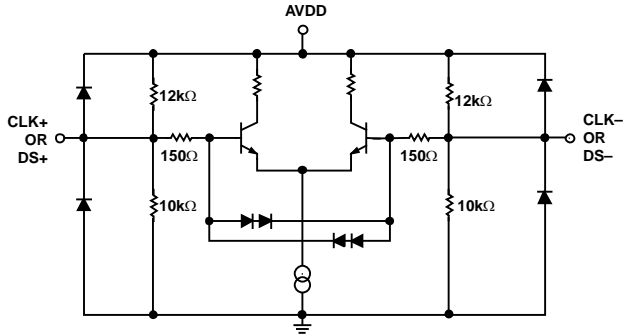

Figure 6. ENCODE and DS Input

02807-080

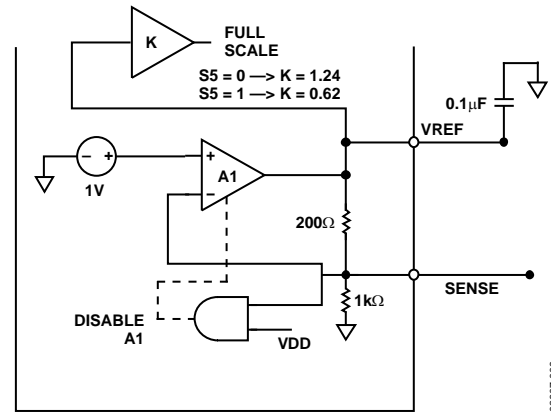

Figure 9. VREF, SENSE I/O

02807-009

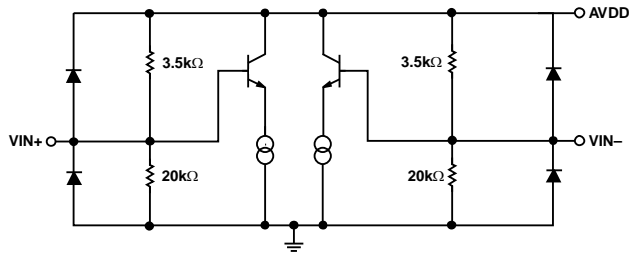

Figure 7. Analog Inputs

02807-007

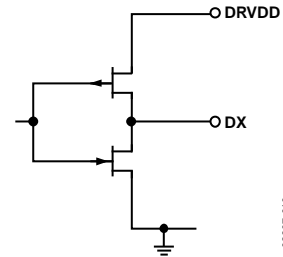

Figure 10. Data Outputs (CMOS Mode)

02807-010

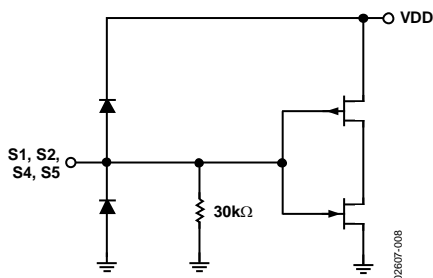

Figure 8. S1 to S5 Inputs

02807-008

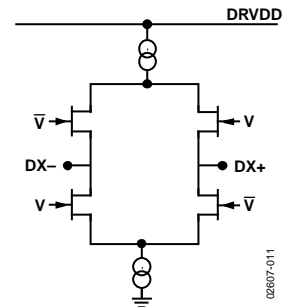

Figure 11. Data Outputs (LVDS Mode)

02807-011

## TYPICAL PERFORMANCE CHARACTERISTICS

Charts at 170 MSPS, 210 MSPS for -170, -210 grades, respectively. AVDD, DRVDD = 3.3 V, T = 25°C, A<sub>IN</sub> differential drive, full scale = 1.536 V, internal reference unless otherwise noted.

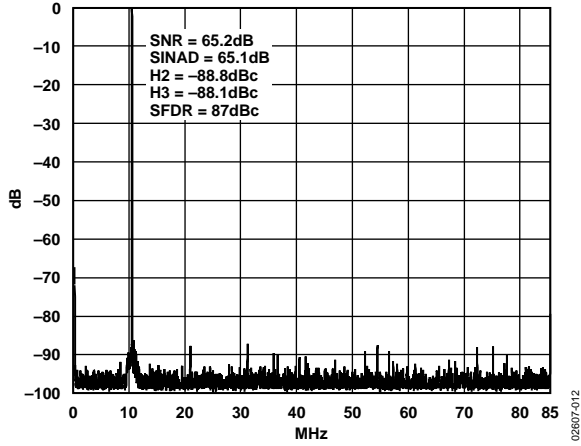

Figure 12. FFT:  $f_s = 170$  MSPS,  $A_{IN} = 10.3$  MHz @  $-0.5$  dBFS, LVDS Mode

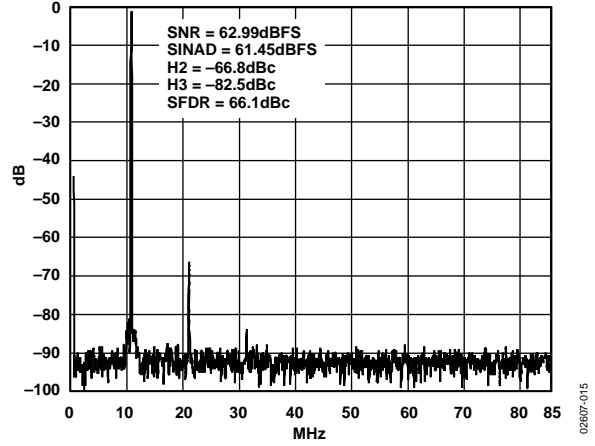

Figure 15. FFT:  $f_s = 170$  MSPS,  $A_{IN} = 10.3$  MHz @  $-0.5$  dBFS, Single-Ended Input, Full Scale = 0.76 V, LVDS Mode

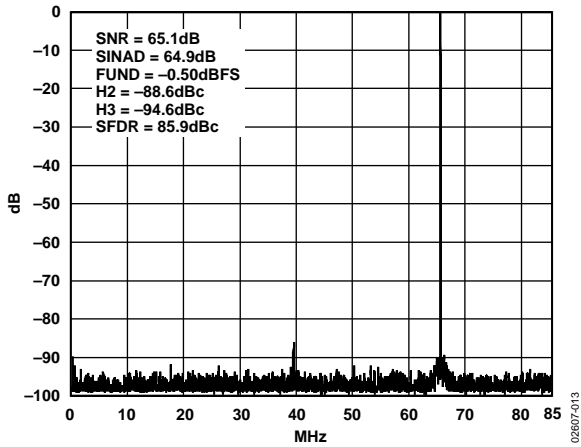

Figure 13. FFT:  $f_s = 170$  MSPS,  $A_{IN} = 65$  MHz @  $-0.5$  dBFS, LVDS Mode

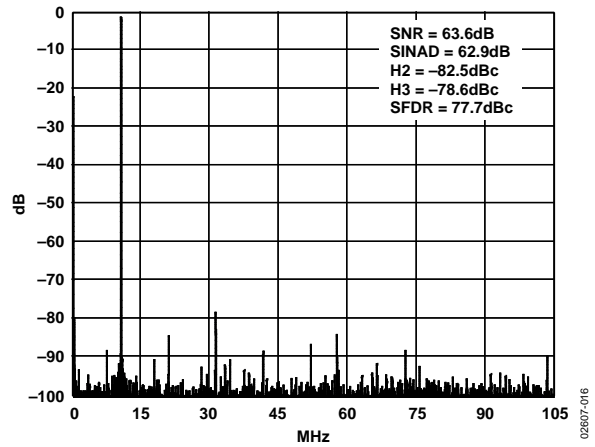

Figure 16. FFT:  $f_s = 210$  MSPS,  $A_{IN} = 10.3$  MHz @  $-0.5$  dBFS, LVDS Mode

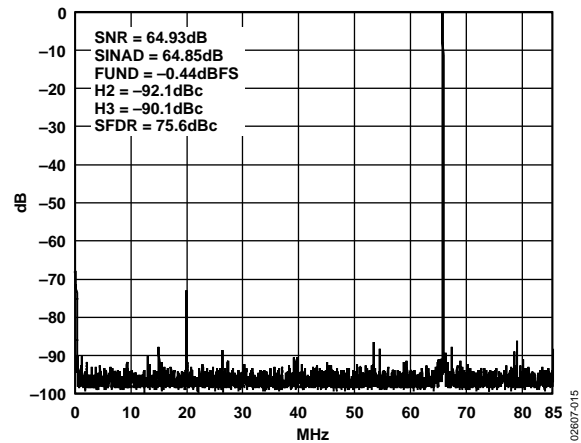

Figure 14. FFT:  $f_s = 170$  MSPS,  $A_{IN} = 65$  MHz @  $-0.5$  dBFS, CMOS Mode

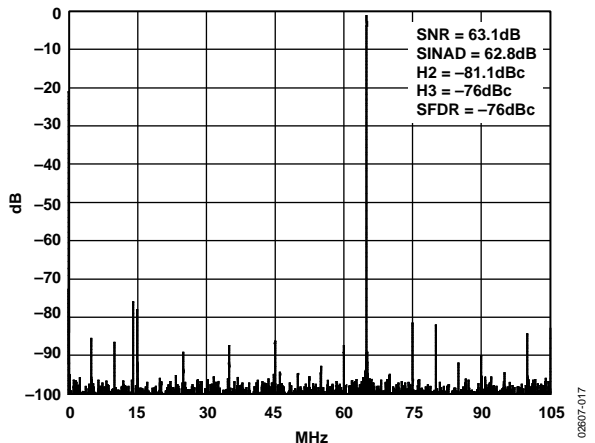

Figure 17. FFT:  $f_s = 210$  MSPS,  $A_{IN} = 65$  MHz @  $-0.5$  dBFS, CMOS Mode



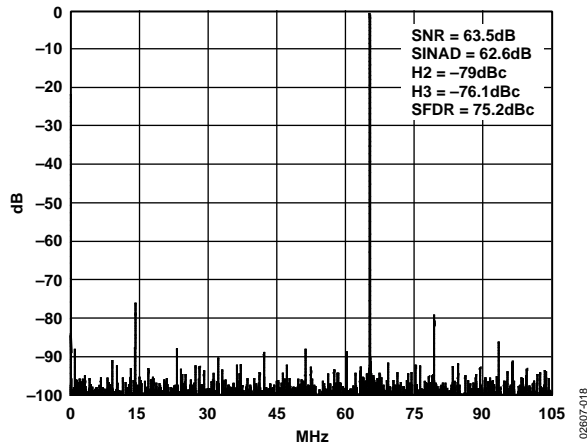

Figure 18. FFT:  $f_s = 210$  MSPS,  $A_{IN} = 65$  MHz @  $-0.5$  dBFS, LVDS Mode

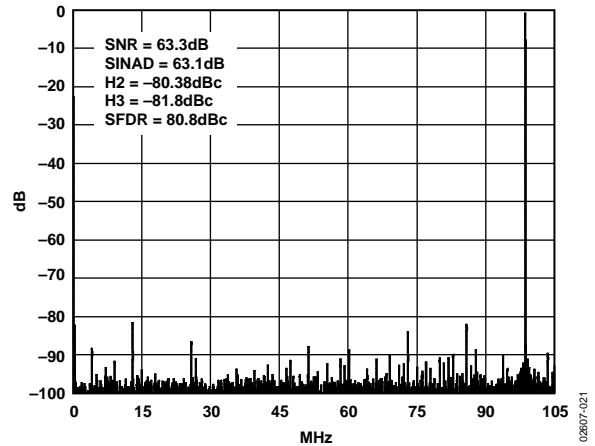

Figure 21. FFT:  $f_s = 213$  MSP,  $A_{IN} = 100$  MHz @  $-0.5$  dBFS, LVDS Mode

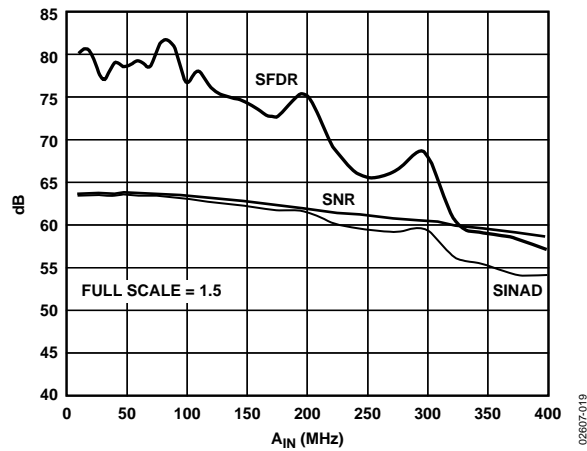

Figure 19. SNR, SINAD, and SFDR vs.  $A_{IN}$  Frequency,  $f_s = 210$  MSPS,  $A_{IN}$  @  $-0.5$  dBFS, LVDS Mode

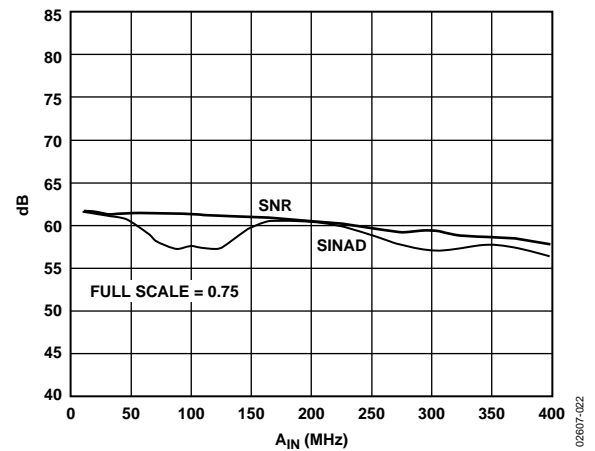

Figure 22. SNR and SINAD vs.  $A_{IN}$  Frequency,  $f_s = 210$  MSPS,  $A_{IN}$  @  $-0.5$  dBFS, LVDS Mode, Full Scale =  $0.76$  V

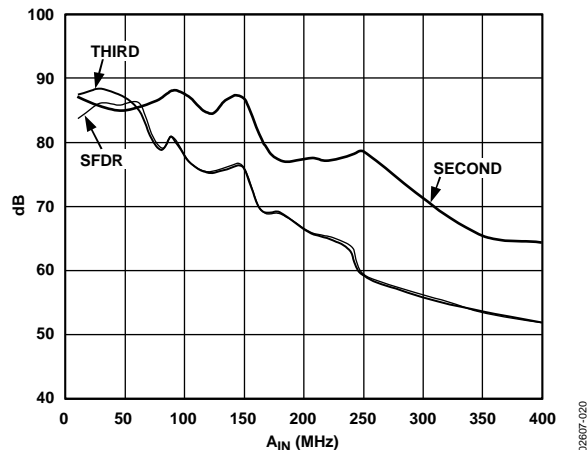

Figure 20. Harmonic Distortion ( $2^{nd}$  and  $3^{rd}$ ) and SFDR vs.  $A_{IN}$  Frequency

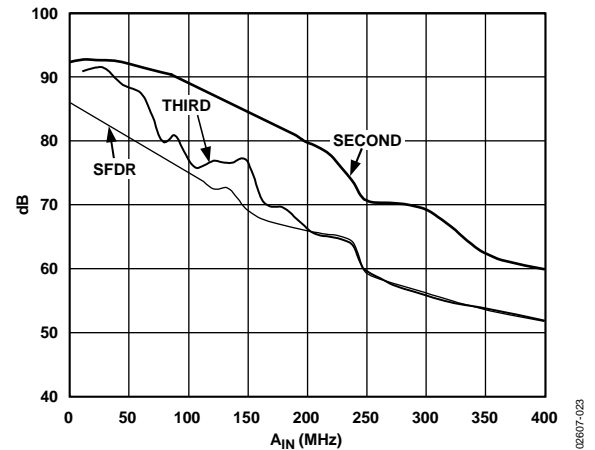

Figure 23. Harmonic Distortion ( $2^{nd}$  and  $3^{rd}$ ) and SFDR vs.  $A_{IN}$  Frequency,  $f_s = 170$  MSPS, CMOS Mode

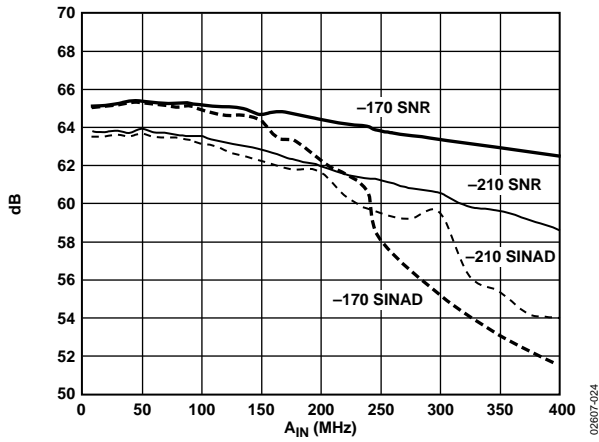

Figure 24. SNR and SINAD vs.  $A_{IN}$  Frequency,  $f_s = 170$  MSPS/210 MSPS,  $A_{IN}$  @  $-0.5$  dBFS, LVDS Mode

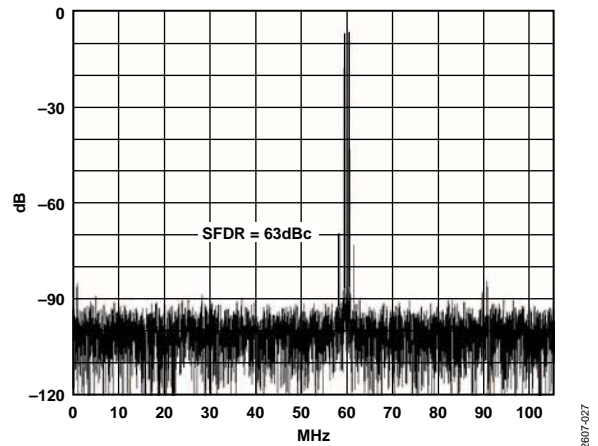

Figure 27. Two-Tone Intermodulation Distortion (59 MHz and 60 MHz), LVDS Mode,  $f_s = 210$  MSPS

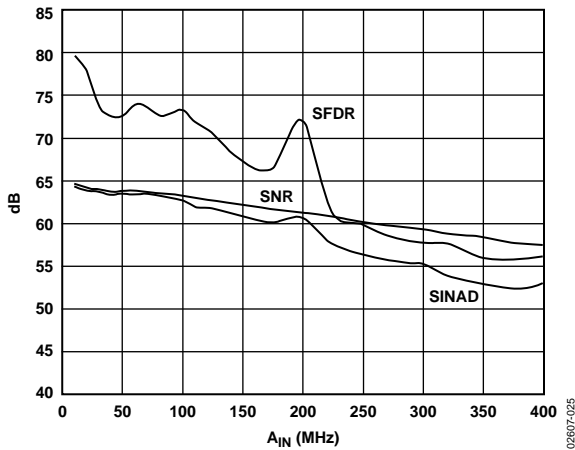

Figure 25. SNR and SINAD, SFDR vs.  $A_{IN}$  Frequency,  $f_s = 210$  MSPS,  $A_{IN}$  @  $-0.5$  dBFS, CMOS Mode

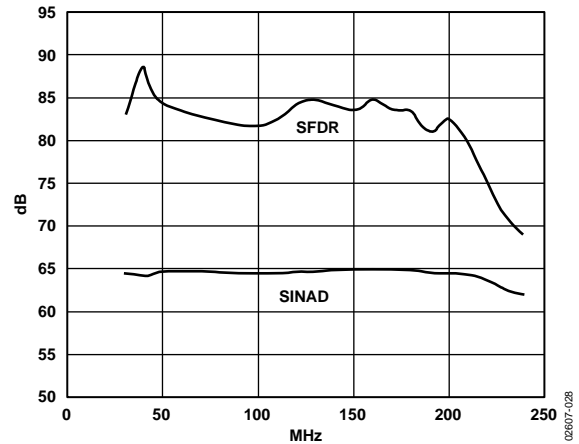

Figure 28. SINAD and SFDR vs. Clock Rate ( $A_{IN} = 10.3$  MHz @  $-0.5$  dBFS, LVDS Mode),  $-170$  Grade

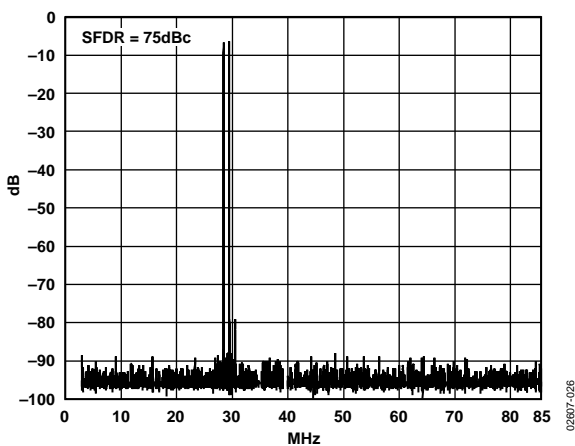

Figure 26. Two-Tone Intermodulation Distortion (28.3 MHz and 29.3 MHz, LVDS Mode,  $f_s = 170$  MSPS)

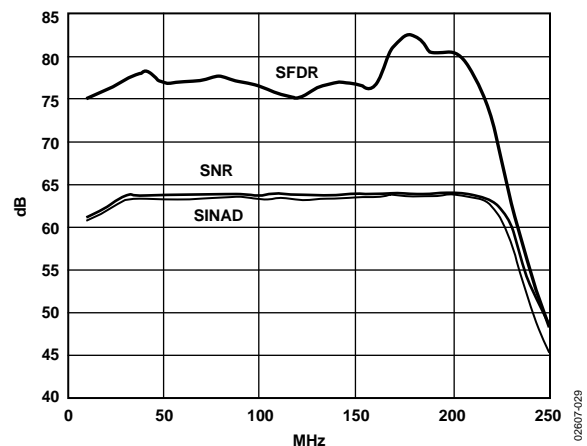

Figure 29. SNR and SINAD, SFDR vs. Clock Rate ( $A_{IN} = 10.3$  MHz, @  $-0.5$  dBFS), LVDS Mode,  $-210$  Grade

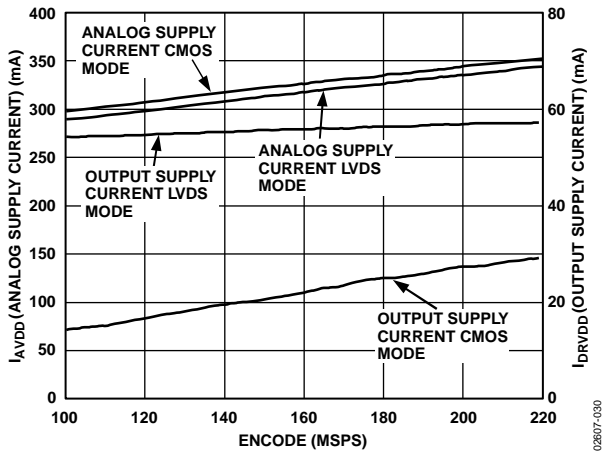

Figure 30.  $I_{AVDD}$  and  $I_{DRVDD}$  vs. Clock Rate ( $A_{IN} = 10.3 \text{ MHz @ } -0.5 \text{ dBFS}$ )  
170 MSPS Grade,  $C_{LOAD} = 5 \text{ pF}$

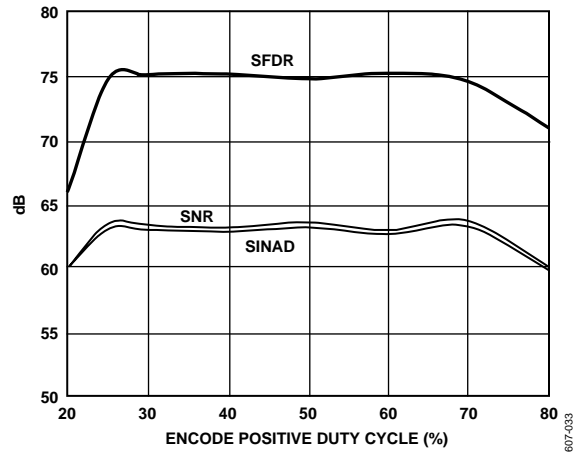

Figure 33. SNR, SINAD, and SFDR vs. ENCODE Pulse Width High,  
( $A_{IN} = 10.3 \text{ MHz @ } -0.5 \text{ dBFS}$ , 210 MSPS, LVDS)

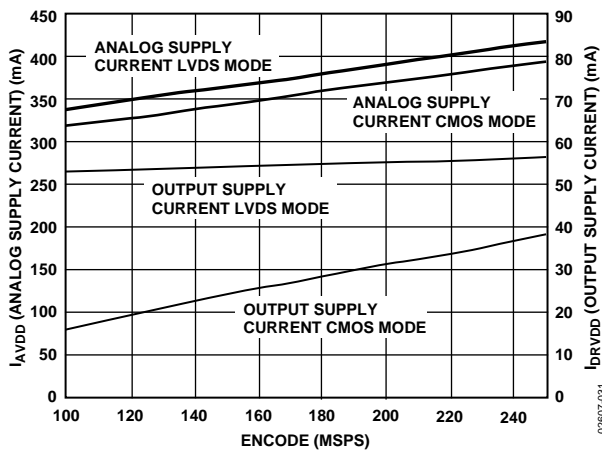

Figure 31.  $I_{AVDD}$  and  $I_{DRVDD}$  vs. Clock Rate  
( $A_{IN} = 10.3 \text{ MHz @ } -0.5 \text{ dBFS}$ ), 210 MSPS Grade,  $C_{LOAD} = 5 \text{ pF}$

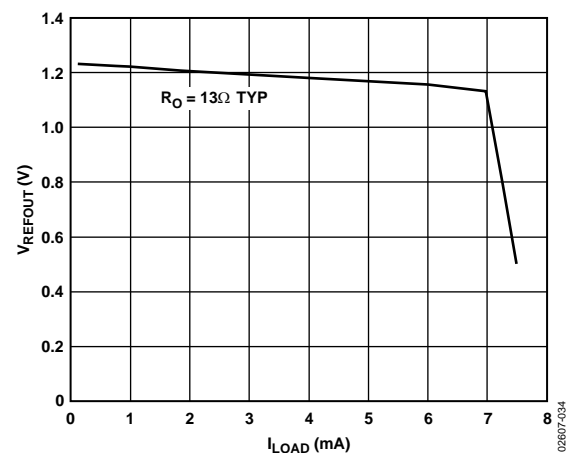

Figure 34.  $V_{REFOUT}$  vs.  $I_{LOAD}$

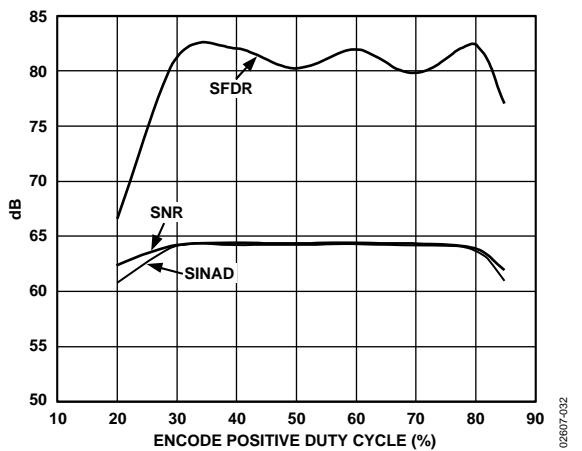

Figure 32. SINAD and SFDR vs. Clock Pulse Width High  
( $A_{IN} = 10.3 \text{ MHz @ } -0.5 \text{ dBFS}$ , 170 MSPS, LVDS)

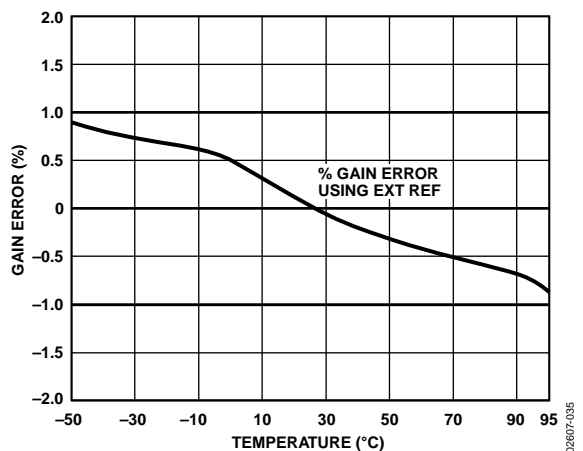

Figure 35. Full-Scale Gain Error vs. Temperature  
( $A_{IN} = 10.3 \text{ MHz @ } -0.5 \text{ dBFS}$ , 170 MSPS/210 MSPS, LVDS)

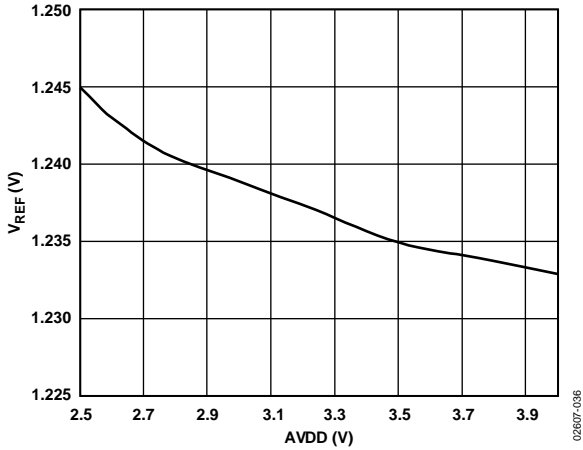

Figure 36.  $V_{REF}$  Output Voltage vs.  $AVDD$

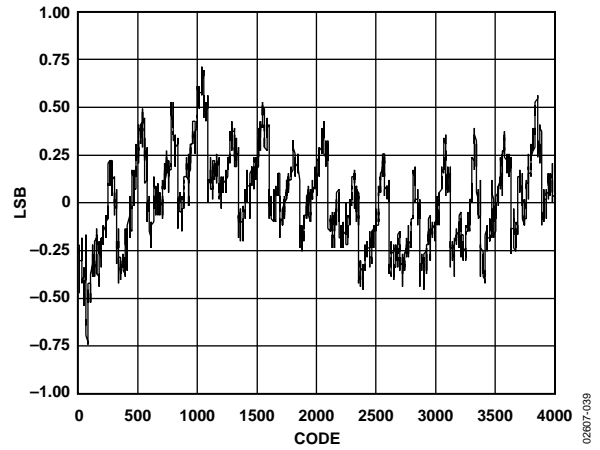

Figure 39. Typical INL Plot ( $A_{IN} = 10.3 \text{ MHz} @ -0.5 \text{ dBFS}$ , 170 MSPS, LVDS)

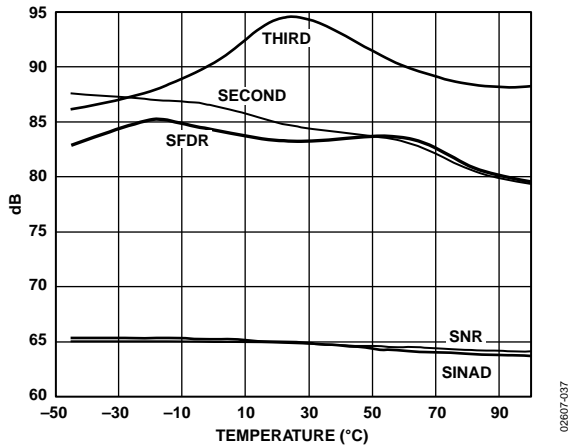

Figure 37. SNR, SINAD, and SFDR vs. Temperature ( $A_{IN} = 10.3 \text{ MHz} @ -0.5 \text{ dBFS}$ , 170 MSPS)

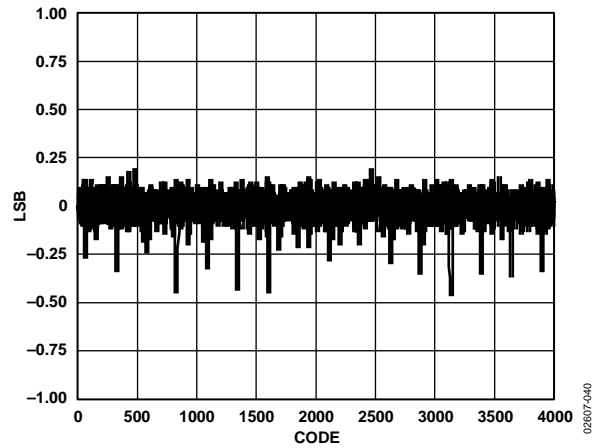

Figure 40. Typical DNL Plot ( $A_{IN} = 10.3 \text{ MHz} @ -0.5 \text{ dBFS}$ )

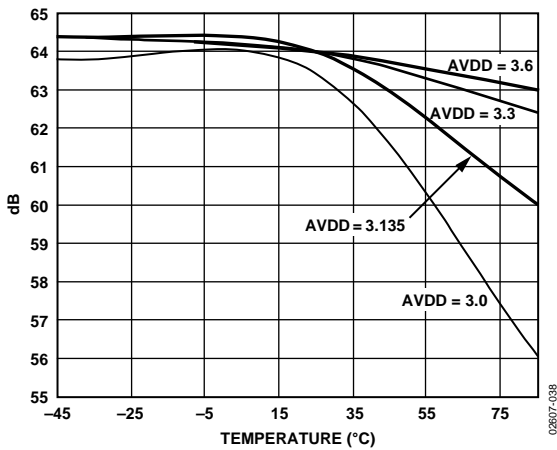

Figure 38. SINAD vs. Temperature,  $AVDD$  ( $A_{IN} = 70 \text{ MHz} @ -0.5 \text{ dB}$ , 210 MSPS, LVDS Mode)

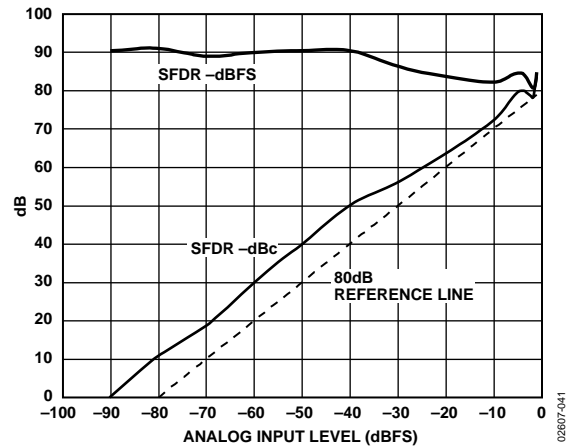

Figure 41. SFDR vs.  $A_{IN}$  Input Level,  $A_{IN} @ 10.3 \text{ MHz}$ , 170 MSPS, LVDS Mode

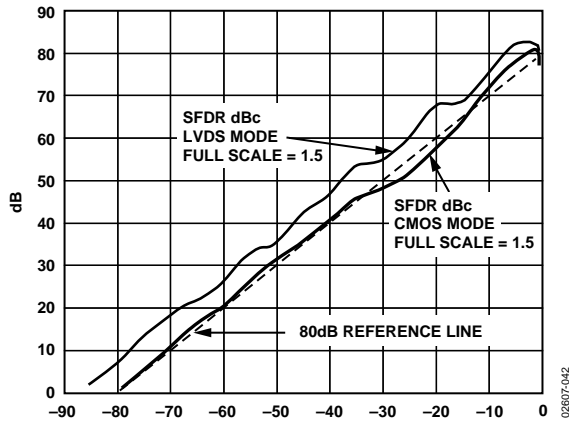

Figure 42. SFDR vs.  $A_{IN}$  Input Level,  $A_{IN}$  @ 10.3 MHz, 210 MSPS, LVDS/CMOS Modes

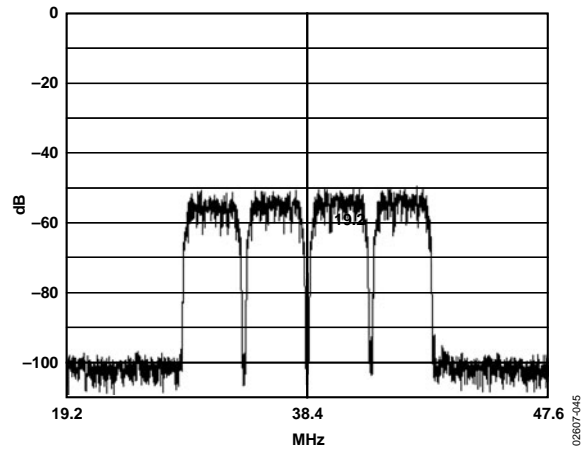

Figure 45. W-CDMA Four Channels Centered at 38.4 MHz,  $f_s = 153.6$  MHz, LVDS Mode

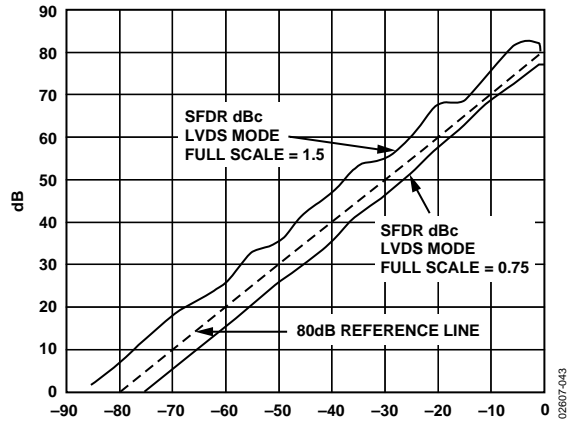

Figure 43. SFDR vs.  $A_{IN}$  Input Level,  $A_{IN}$  @ 10.3 MHz, 210 MSPS, LVDS Mode, Full Scale = 0.76 V/1.536 V

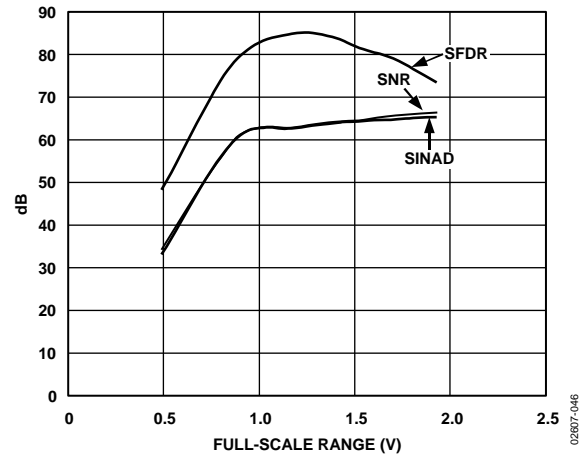

Figure 46. SNR, SINAD, and SFDR vs. Full-Scale Range,  $S_5 = 0$ , Full-Scale Range Varied by Adjusting  $V_{REF}$ , 170 MSPS

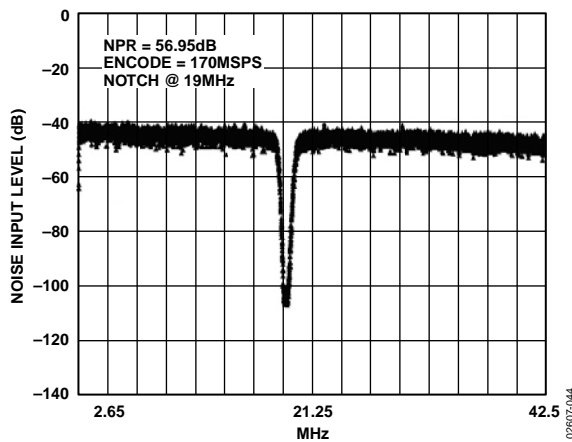

Figure 44. Noise Power Ratio Plot

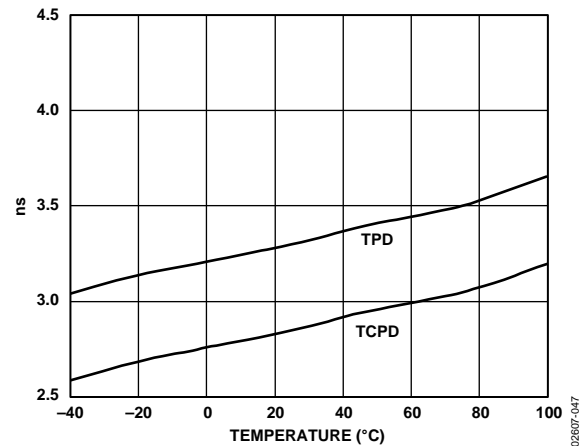

Figure 47. Propagation Delay vs. Temperature, LVDS Mode, 170 MSPS/210 MSPS

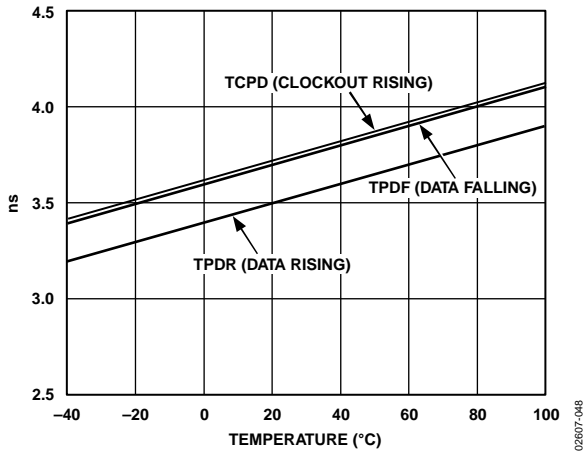

Figure 48. Propagation Delay vs. Temperature, CMOS Mode, 170 MSPS/210 MSPS

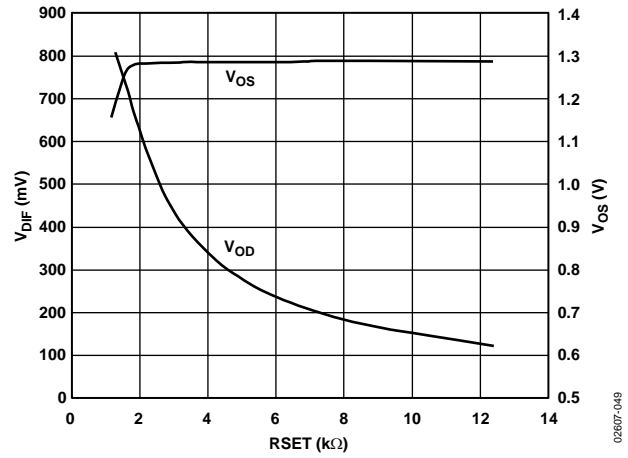

Figure 49. LVDS Output Swing, Common-Mode Voltage vs. RSET, Placed at LVDSBIAS, 170 MSPS/210 MSPS

## TERMINOLOGY

### Analog Bandwidth

The analog input frequency at which the spectral power of the fundamental frequency (as determined by the FFT analysis) is reduced by 3 dB.

### Aperture Delay

The delay between the 50% point of the rising edge of the ENCODE command and the instant at which the analog input is sampled.

### Aperture Uncertainty (Jitter)

The sample-to-sample variation in aperture delay.

### Crosstalk

Coupling onto one channel being driven by a low level (–40 dBFS) signal when the adjacent interfering channel is driven by a full-scale signal.

### Differential Analog Input Resistance, Differential Analog Input Capacitance, and Differential Analog Input Impedance

The real and complex impedances measured at each analog input port. The resistance is measured statically and the capacitance and differential input impedances are measured with a network analyzer.

### Differential Analog Input Voltage Range

The peak-to-peak differential voltage that must be applied to the converter to generate a full-scale response. Peak differential voltage is computed by observing the voltage on a single pin and subtracting the voltage from the other pin, which is 180° out of phase. Peak-to-peak differential is computed by rotating the input phase 180° and again taking the peak measurement. The difference is then computed between both peak measurements.

### Differential Nonlinearity

The deviation of any code width from an ideal 1 LSB step.

### Effective Number of Bits (ENOB)

Calculated from the measured SNR based on the equation

$$ENOB = \frac{SNR_{MEASURED} - 1.76\text{dB}}{6.02}$$

### ENCODE Pulse Width/Duty Cycle

Pulse width high is the minimum amount of time the ENCODE pulse (clock pulse) should be left in a Logic 1 state to achieve rated performance; pulse width low is the minimum time the ENCODE pulse should be left in a low state. See the timing implications of changing  $t_{EH}$  in the Encode Input section. At a given clock rate, these specifications define an acceptable ENCODE duty cycle.

### Full-Scale Input Power

Expressed in dBm. Computed using the following equation:

$$Power_{FULL\ SCALE} = 10 \log \left( \frac{V^2_{FULL\ SCALE\ rms}}{\frac{Z_{INPUT}}{0.001}} \right)$$

### Gain Error

The difference between the measured and ideal full-scale input voltage range of the ADC.

### Harmonic Distortion, Second

The ratio of the rms signal amplitude to the rms value of the second harmonic component, reported in dBc.

### Harmonic Distortion, Third

The ratio of the rms signal amplitude to the rms value of the third harmonic component, reported in dBc.

### Integral Nonlinearity

The deviation of the transfer function from a reference line measured in fractions of 1 LSB using a best straight line determined by a least square curve fit.

### Minimum Conversion Rate

The ENCODE rate at which the SNR of the lowest analog signal frequency drops by no more than 3 dB below the guaranteed limit.

### Maximum Conversion Rate

The ENCODE rate at which parametric testing is performed.

### Output Propagation Delay

The delay between a differential crossing of CLK+ and CLK– and the time when all output data bits are within valid logic levels.

### Noise (for Any Range Within the ADC)

Calculated as follows:

$$V_{NOISE} = \sqrt{Z \times 0.001 \times 10 \left( \frac{FS_{dBm} - SNR_{dBc} - Signal_{dBFS}}{10} \right)}$$

where:

$Z$  is the input impedance.

$FS$  is the full scale of the device for the frequency in question.

$SNR$  is the value of the particular input level.

$Signal$  is the signal level within the ADC, reported in dB below full scale. This value includes input levels both thermal and quantization noise.

**Power Supply Rejection Ratio**

The ratio of a change in input offset voltage to a change in power supply voltage.

**Signal-to-Noise and Distortion (SINAD)**

The ratio of the rms signal amplitude (set 1 dB below full scale) to the rms value of the sum of all other spectral components, including harmonics but excluding dc.

**Signal-to-Noise Ratio (Without Harmonics)**

The ratio of the rms signal amplitude (set at 1 dB below full scale) to the rms value of the sum of all other spectral components, excluding the first five harmonics and dc.

**Spurious-Free Dynamic Range (SFDR)**

The ratio of the rms signal amplitude to the rms value of the peak spurious spectral component. The peak spurious component may or may not be a harmonic. Reported in dBc (degrades as signal level is lowered) or dBFS (always related back to converter full scale).

**Two-Tone Intermodulation Distortion Rejection**

The ratio of the rms value of either input tone to the rms value of the worst third-order intermodulation product; reported in dBc.

**Two-Tone SFDR**

The ratio of the rms value of either input tone to the rms value of the peak spurious component. The peak spurious component may or may not be an IMD product. Reported in dBc (degrades as signal level is lowered) or in dBFS (always related back to converter full scale).

**Worst Other Spur**

The ratio of the rms signal amplitude to the rms value of the worst spurious component (excluding the second and third harmonic) reported in dBc.

**Transient Response Time**

The time it takes for the ADC to reacquire the analog input after a transient from 10% above negative full scale to 10% below positive full scale.

**Out-of-Range Recovery Time**

The time it takes for the ADC to reacquire the analog input after a transient from 10% above positive full scale to 10% above negative full scale, or from 10% below negative full scale to 10% below positive full scale.



## APPLICATION NOTES

### THEORY OF OPERATION

The AD9430 architecture is optimized for high speed and ease of use. The analog inputs drive an integrated high bandwidth track-and-hold circuit that samples the signal prior to quantization by the 12-bit core. For ease of use, the part includes an on-board reference and input logic that accepts TTL, CMOS, or LVPECL levels. The digital output logic levels are user selectable as standard 3 V CMOS or LVDS (ANSI-644 compatible) via Pin S2.

### ENCODE INPUT

Any high speed ADC is extremely sensitive to the quality of the sampling clock provided by the user. A track-and-hold circuit is essentially a mixer, and any noise, distortion, or timing jitter on the clock is combined with the desired signal at the A/D output. For that reason, considerable care has been taken in the design of the clock inputs of the AD9430, and the user is advised to give careful thought to the clock source.

The AD9430 has an internal clock duty cycle stabilization circuit that locks to the rising edge of CLK+ and optimizes timing internally. This allows for a wide range of input duty cycles at the input without degrading performance. Jitter in the rising edge of the input is still of paramount concern and is not reduced by the internal stabilization circuit. The duty cycle control loop does not function for clock rates less than 30 MHz nominally. The loop has a time constant associated

with it that needs to be considered in applications where the clock rate can change dynamically, requiring a wait time of 1.5  $\mu$ s to 5  $\mu$ s after a dynamic clock frequency increase before valid data is available. This circuit is always on and cannot be disabled by the user.

The clock inputs are internally biased to 1.5 V (nominal) and support either differential or single-ended signals. For best dynamic performance, a differential signal is recommended. An MC100LVEL16 performs well in the circuit to drive the clock inputs, as illustrated in Figure 50. (For trace lengths >2 inches, a standard LVPECL termination is recommended rather than the simple pull-down as shown.) Note that for this low voltage PECL device, the ac coupling is optional.

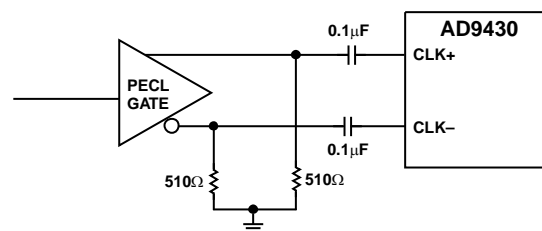

Figure 50. Driving Clock Inputs with LVEL16

In interleaved mode, output data on Port A is offset from output data changes on Port B by one-half output clock cycle, as shown in Figure 51.

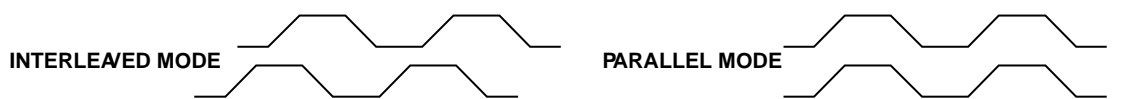

Figure 51.

Table 9. Output Select Coding

S1 <sup>1</sup> (Data Format Select)	S2 <sup>1</sup> (LVDS/CMOS Mode Select) <sup>2</sup>	S4 <sup>1</sup> (I/P Select)	S5 <sup>1</sup> (Full-Scale Select) <sup>3</sup>	Mode
1	X	X	X	Two's complement
0	X	X	X	Offset binary
X	0	1	X	Dual-mode CMOS interleaved
X	0	0	X	Dual-mode CMOS parallel
X	1	X	X	LVDS mode
X	X	X	1	Full scale = 0.768 V
X	X	X	0	Full scale = 1.536 V

<sup>1</sup> X = don't care.

<sup>2</sup> S4 used in CMOS mode only (S2 = 0). S1 to S5 all have 30 k $\Omega$  resistive pull-downs on chip.

<sup>3</sup> S5 full-scale adjust (see the Analog Input section).

## ANALOG INPUT

The analog input to the AD9430 is a differential buffer. For best dynamic performance, impedances at  $V_{IN+}$  and  $V_{IN-}$  should match. The analog input is optimized to provide superior wideband performance and requires that the analog inputs be driven differentially. SNR and SINAD performance degrades significantly if the analog input is driven with a single-ended signal.

A wideband transformer such as the Mini-Circuit® ADT1-1WT can provide the differential analog inputs for applications that require a single-ended-to-differential conversion. Both analog inputs are self-biased by an on-chip resistor divider to a nominal 2.8 V. (See the Equivalent Circuits section.)

Special care was taken in the design of the analog input section of the AD9430 to prevent damage and corruption of data when the input is overdriven. The nominal differential input range is approximately 1.5 V p-p  $\sim (768 \text{ mV} \times 2)$ . Note that the best SNR performance is achieved with  $S5 = 0$  (full scale = 1.5).

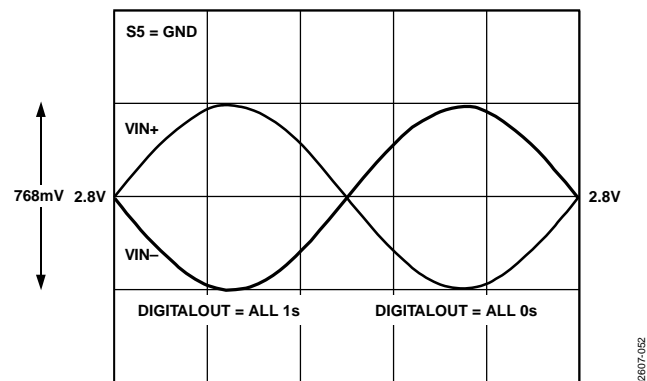

Figure 52. Differential Analog Input Range

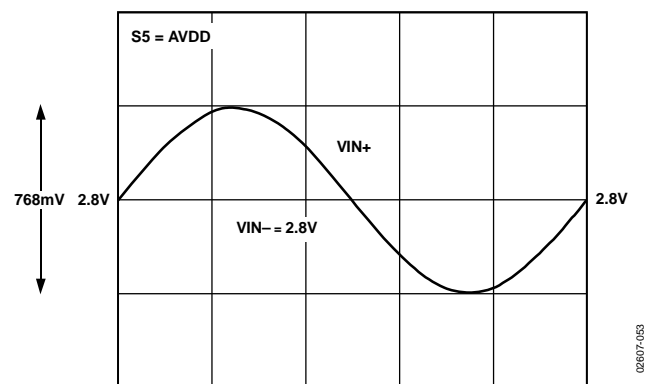

Figure 53. Single-Ended Analog Input Range

## DS INPUTS (DS+, DS-)

In CMOS output mode, the data sync inputs (DS+, DS-) can be used in applications that require a given sample to appear at a specific output port (A or B) relative to a given external timing signal. The DS inputs can also be used to synchronize two or more ADCs in a system to maintain phasing between Port A and Port B on separate ADCs (in effect, synchronizing multiple DCO outputs). When DS+ is held high (DS- low), the ADC data outputs and clock do not switch and are held static.

Synchronization is accomplished by the assertion (falling edge) of DS+ within the timing constraints  $t_{SDS}$  and  $t_{HDS}$ , relative to a clock rising edge. (On initial synchronization,  $t_{HDS}$  is not relevant.) If DS+ falls within the required setup time ( $t_{SDS}$ ) before a given clock rising edge, N, the analog value at that point in time is digitized and available at Port A, 14 cycles later in interleaved mode.

The very next sample, N + 1, is sampled by the next rising clock edge and available at Port B, 14 cycles after that clock edge. In dual-parallel mode, Port A has a 15-cycle latency and Port B has a 14-cycle latency, but data is available at the same time. Driving the DS inputs of each ADC by the same sync signal accomplishes this. An easy way to accomplish synchronization is by a one-time sync at power-on reset. Note that when running the AD9430 in LVDS mode, set DS+ to ground and DS- to 3.3 V, as the DS inputs are relevant only in CMOS output mode, simplifying the design for some applications as well as affording superior SNR/SINAD performance at higher encode/analog frequencies.

## CMOS OUTPUTS

The off-chip drivers on the chip can be configured to provide CMOS-compatible output levels via Pin S2. The CMOS digital outputs ( $S2 = 0$ ) are TTL/CMOS compatible for lower power consumption. The outputs are biased from a separate supply (DRVDD), allowing easy interface to external logic. The outputs are CMOS devices that swing from ground to DRVDD (with no dc load). It is recommended to minimize the capacitive load the ADC drives by keeping the output traces short (<1 inch, for a total  $C_{LOAD} < 5 \text{ pF}$ ). When operating in CMOS mode, it is also recommended to place low value ( $20 \Omega$ ) series damping resistors on the data lines to reduce switching transient effects on performance.

## LVDS OUTPUTS

The off-chip drivers on the chip can be configured to provide LVDS-compatible output levels via Pin S2. LVDS outputs are available when  $S2 = VDD$  and a 3.74 k $\Omega$  RSET resistor is placed at Pin 7 (LVDSBIAS) to ground. The RSET resistor current is ratioed on-chip, setting the output current at each output equal to a nominal 3.5 mA ( $11 \times IRSET$ ). A 100  $\Omega$  differential termination resistor placed at the LVDS receiver inputs results in a nominal 350 mV swing at the receiver. LVDS mode facilitates interfacing with LVDS receivers in custom ASICs and FPGAs that have LVDS capability for superior switching performance in noisy environments. Single point-to-point net topologies are recommended with a 100  $\Omega$  termination resistor as close to the receiver as possible. It is recommended to keep the trace length three to four inches maximum and to keep differential output trace lengths as equal as possible.

## CLOCK OUTPUTS (DCO+, DCO-)

The input ENCODE is divided by two (in CMOS mode) and available off chip at DCO+ and DCO-. These clocks can facilitate latching off chip, providing a low skew clocking solution (see Figure 2). The on-chip clock buffers should not drive more than 5 pF of capacitance to limit switching transient effects on performance. Note that the output clocks are CMOS levels when CMOS mode is selected ( $S2 = 0$ ) and are LVDS levels when in LVDS mode ( $S2 = VDD$ ), requiring a 100  $\Omega$  differential termination at receiver in LVDS mode. The output clock in LVDS mode switches at the ENCODE rate.

## VOLTAGE REFERENCE

A stable and accurate 1.23 V voltage reference is built into the AD9430 (VREF). The analog input full-scale range is linearly proportional to the voltage at VREF. Note that an external reference can be used by connecting the SENSE pin to VDD (disabling internal reference) and driving VREF with the external reference source. No appreciable degradation in performance occurs when VREF is adjusted  $\pm 5\%$ . A 0.1  $\mu\text{F}$  capacitor to ground is recommended at the VREF pin in internal and external reference applications. Float the SENSE pin for internal reference operation.

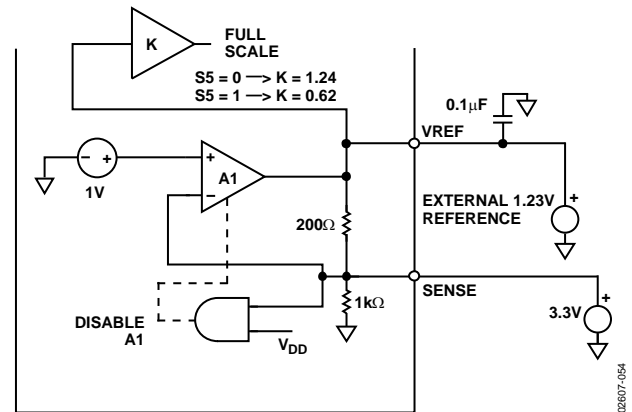

Figure 54. Using an External Reference

## NOISE POWER RATIO TESTING (NPR)

NPR is a test that is commonly used to characterize the return path of cable systems where the signals are typically QAM signals with a noise-like frequency spectrum. NPR performance of the AD9430 was characterized in the lab yielding an effective NPR = 56.9 dB at an analog input of 19 MHz. This agrees with a theoretical maximum NPR of 57.1 dB for an 11-bit ADC at 13.6 dB backoff. The rms noise power of the signal inside the notch is compared with the rms noise level outside the notch using an FFT. Sufficiently long record lengths to guarantee a sufficient number of samples inside the notch are a requirement, as well as a high order band-stop filter that provides the required notch depth for testing.

## EVALUATION BOARD, CMOS MODE

The AD9430 evaluation board offers an easy way to test the AD9430 in CMOS mode. It requires a clock source, an analog input signal, and a 3.3 V power supply. The clock source is buffered on the board to provide the clocks for the ADC, latches, and data ready signals. The digital outputs and output clocks are available at two 40-pin connectors, P3 and P23. The PCB interfaces directly with ADI standard dual-channel data capture board (HSC-ADC-EVAL-DC) which, together with ADI ADC Analyzer software, allows for quick ADC evaluation. The board has several different modes of operation and is shipped in the following configurations:

- Offset binary
- Internal voltage reference
- CMOS parallel timing
- Full-scale adjust = low

### POWER CONNECTOR

Power is supplied to the board via a detachable 12-lead power strip (three 4-pin blocks). AVDD, DRVDD, and VDL are the minimum required power connections.

**Table 10. Power Connector, CMOS Mode**

AVDD 3.3 V	Analog supply for ADC (350 mA)
DRVDD 3.3 V	Output supply for ADC (28 mA)
VDL 3.3 V	Supply for support logic and DAC (350 mA)
EXT_VREF	Optional external reference input
VCLK/V_XTAL	Supply for clock buffer/optional CRYSTAL
VAMP	Supply for optional amp

### ANALOG INPUTS

The evaluation board accepts a 1.3 V p-p analog input signal centered at ground at SMB connector J4. This signal is terminated to ground through 50  $\Omega$  by R16. The input can be alternatively terminated at the transformer T1 secondary by R13 and R14. T1 is a wideband RF transformer providing the single-ended-to-differential conversion, allowing the ADC to be driven differentially and minimizing even-order harmonics. An optional second transformer, T2, can be placed following T1 if desired. This provides some performance advantage (~1 dB to 2 dB) for high analog input frequencies (>100 MHz). If T2 is placed, two shorting traces at the pads need to be cut. The analog signal is low-pass filtered by R41, C12 and R42, and C13 at the ADC input.

### GAIN

Full scale is set at E17, E18, and E19. Connecting E17 to E18 sets S5 low, full scale = 1.5 V differential; connecting E17 to E19 sets S5 high, full scale = 0.75 V differential.

### ENCODE

The ENCODE clock is terminated to ground through 50  $\Omega$  at SMB Connector J5. The input is ac coupled to a high speed differential receiver (LVEL16) that provides the required low jitter, fast edge rates needed for optimum performance. J5 input should be >0.5 V p-p. Power to the EL16 is set at Jumper E47. Connecting E47 to E45 powers the buffer from AVDD; connecting E47 to E46 powers the buffer from VCLK/V\_XTAL.

### VOLTAGE REFERENCE

The AD9430 has an internal 1.23 V voltage reference. The ADC uses the internal reference as the default when jumpers E24 to E27 and E25 to E26 are left open. The full scale can be increased by placing optional Resistor R3. The required value varies with the process and needs to be tuned for the specific application. Full scale can similarly be reduced by placing R4; tuning is required here as well. An external reference can be used by shorting the SENSE pin to 3.3 V (place Jumper E26 to E25). The E27 to E24 jumper connects the ADC VREF pin to the EXT\_VREF pin at the power connector.

### DATA FORMAT SELECT

Data format select sets the output data format of the ADC. Setting DFS (E1 to E2) low sets the output format to be offset binary; setting DFS high (E1 to E3) sets the output to twos complement.

### I/P TIMING SELECT

Output timing is set at E11, E12 and E13. E12 to E11 sets S4 low for parallel output timing mode. E11 to E13 sets S4 high for interleaved timing mode.

### TIMING CONTROLS

Flexibility in latch clocking and output timing is accomplished by allowing for clock inversion at the timing controls section of the PCB. Each buffered clock is buffered by an XOR and can be inverted by moving the appropriate jumper for that clock.

## CMOS DATA OUTPUTS

The ADC CMOS digital outputs are latched on the board by four LVT574s; the latch outputs are available at the two 40-pin connectors at Pin 11 through Pin 33 on P23 (Channel A) and Pin 11 through Pin 33 on P3 (Channel B). The latch output clocks (data ready) are available at Pin 37 on P23 (Channel A) and Pin 37 on P3 (Channel B). The data-ready clocks can be inverted at the timing controls section if needed.

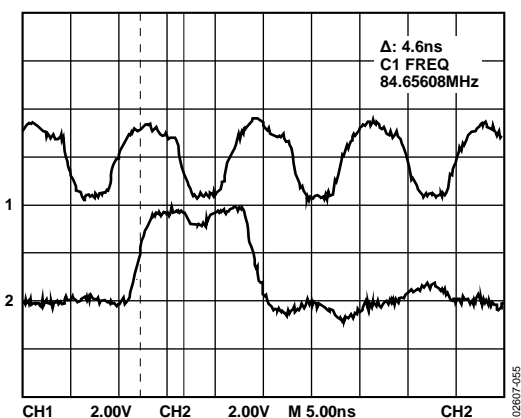

Figure 55. Data Output and Clock @ 80-Pin Connector

## CRYSTAL OSCILLATOR

An optional crystal oscillator can be placed on the board to serve as a clock source for the PCB. Power to the oscillator is through the VCLK pin at the power connector (also called VCLK/V\_XTAL). If an oscillator is used, ensure proper termination for best results. The board has been tested with a Valpey Fisher VF561 and a Vectron JN00158-163.84. Test results for the VF561 are shown in Figure 56.

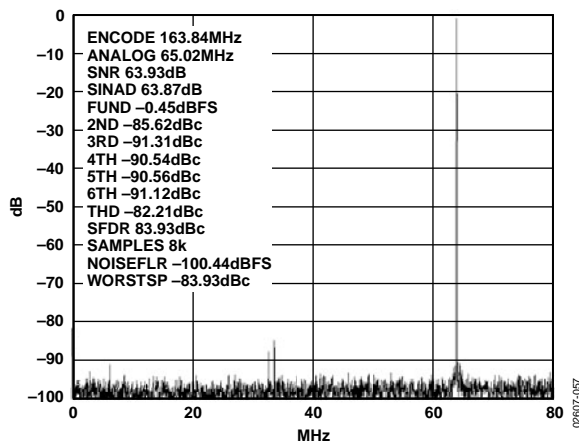

Figure 56. FFT—Using VF561 Crystal as Clock Source

## OPTIONAL AMPLIFIER

The evaluation board as shipped uses a wideband RF transformer in its analog path. A user can modify the board to use the AD8351 op amp for ac- or dc-coupled applications (see Figure 59 and Figure 60). Figure 60 shows the AD8351 in an ac-coupled topology, while Figure 57 shows the AD8351 in a dc-coupled application. Optimum performance is obtained with the AD8351 ac coupled.

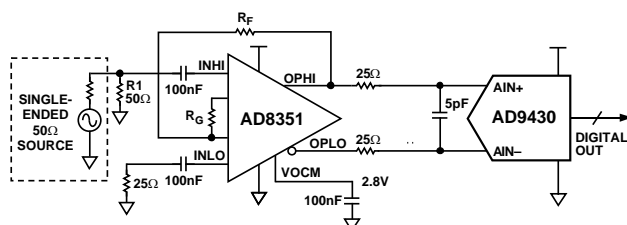

Figure 57. Using the AD8351 on the AD9430 PCB

# AD9430

## TROUBLESHOOTING

If the board does not seem to be working correctly, try the following:

- Verify power at IC pins.
- Check that all jumpers are in the correct position for the desired mode of operation.
- Verify that VREF is at 1.23 V.
- Run the clock and analog inputs at low speeds (10 MSPS/ 1 MHz) and monitor latch and ADC for toggling.

The AD9430 evaluation board is provided as a design example for customers of Analog Devices, Inc. ADI makes no warranties, express, statutory, or implied, regarding merchantability or fitness for a particular purpose.

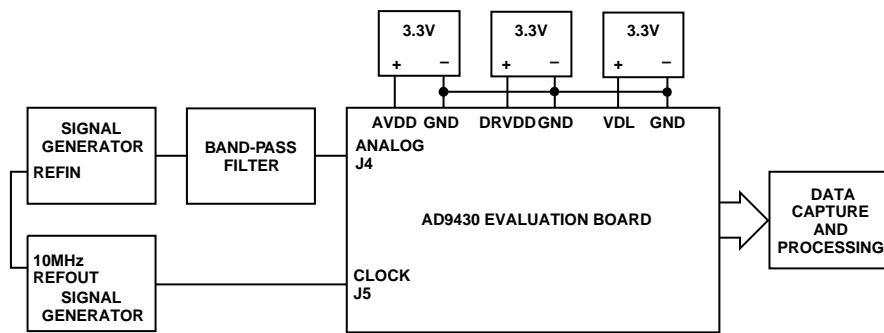

Figure 58. Evaluation Board Connections

02807-059

Table 11. CMOS PCB Evaluation Board Bill of Material

No.	Quantity	Reference Designator	Device	Package	Value	Comments
1	47	C1, C3–C11, C15–C44, C47, C48, C58–C62	Capacitor	0402	0.1 $\mu$ F	C11, C18, C30, C33, C34, C39, C40, C48 Not placed
2	1	C2	Capacitor	0402	10 pF	Not placed
3	1	C12	Capacitor	0402	20 pF	Not placed
4	29	C13, C14, C45, C46, C50–C57, C68–C84	Capacitor	0402	0.01 $\mu$ F	All .01 $\mu$ F caps not placed
5	6	C49, C63–C67	Capacitor	CAPL	10 $\mu$ F	
6	8	(E3, E1, E2),(E19, E17, E18), (E13, E11, E12),(E46, E47, E45), (E35, E33, E34),(E32, E30, E31), (E29, E23, E28),(E22, E16, E21)	3-pin header/jumper			
7	1	E26, E25, E27, E24	4-pin header/jumper			
8	4	J1, J2, J4, J5	SMA	SMA		J2 not placed
9	2	P3, P23 <sup>1</sup>	Connector			
10	3	P4, P21, P22	4-pin power connector	Post	Z5.531.3425.0	Wieland
11	3	P4, P21, P22	4-pin power connector	Detachable connector	25.602.5453.0	Wieland
12	4	R1, R5, R16, R27	Resistor	0402	50 $\Omega$	R1 not placed
13	3	R2, R3, R4	Resistor	0402	3.8K $\Omega$	R3, R4 not placed
14	8	R6–R8, R10, R33–R36	Resistor	0603	100 $\Omega$	R34 not placed
15	2	R9, R11	Resistor	0402	0 $\Omega$	
16	17	R12, R15, R21–R26, R28–R31, R37, R38, R43, R46, R47	Resistor	0402	User selected	All 17 not placed
17	6	R13, R14, R41, R42, R44, R45	Resistor	0402	25 $\Omega$	R13, R14, R44, R45 not placed
18	2	R17, R18	Resistor	0402	510 $\Omega$	
19	2	R19, R20	Resistor	0402	150 $\Omega$	
20	2	R39, R40	Resistor	0402	1 k $\Omega$	
21	8	RZ1, RZ2, RZ3, RZ4, RZ5, RZ6, RZ7, RZ8	Resistor pack 220 $\Omega$	SO16RES	742C163221JTR	CTS
22	1	L1	Inductor	0603	User selected	Not placed
23	2	T1, T4	Transformer	CD542	Mini-Circuits ADT1–1WT	T4 not placed
24	2	T2, T3	Optional Macom Transformer	SM-22	ETC1–1–13	Not placed
25	1	U1	AD9430BSV (–210)	TQFP100	ADC	
26	1	U2	MC100LVEL16D	SO8NB	Clock buffer	
27	1	U3	VCX86	SO14NB	XOR	
28	4	U4, U5, U6, U7	LVT574	SO20		
29	1	U8	JN00158		Optional XTAL	Not placed
30	1	U9	AD8351		Amp	

<sup>1</sup> P3 and P23 are implemented as one physical 80-pin connector, the SAMTEC TSW-140-08-L-D-RA.

# AD9430

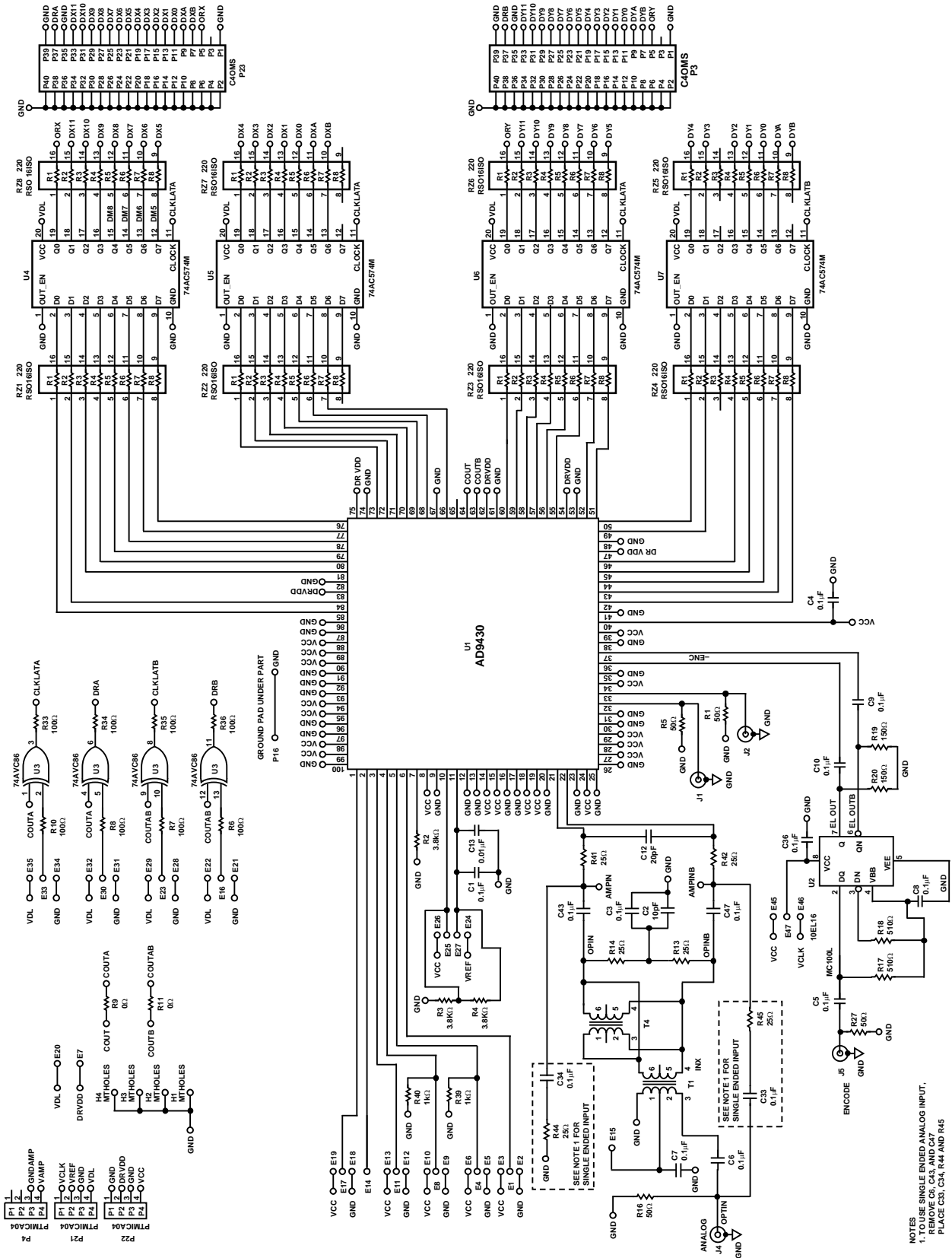
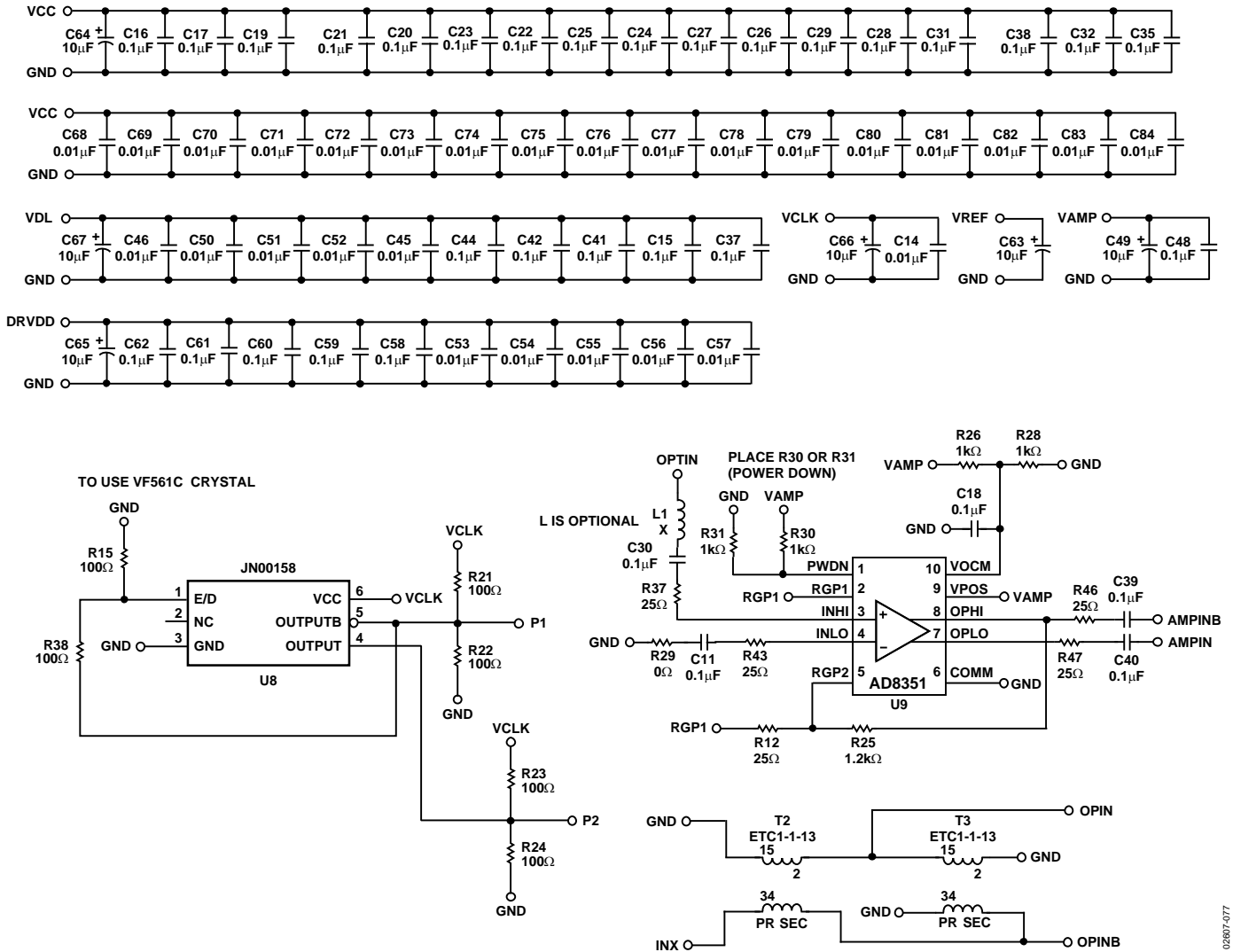

Figure 59. Evaluation Board Schematic—CMOS

NOTES  
 1. TO USE SINGLE ENDED ANALOG INPUT, PLACE C3, C34, R44 AND R45

026307-080





02807-077

# AD9430

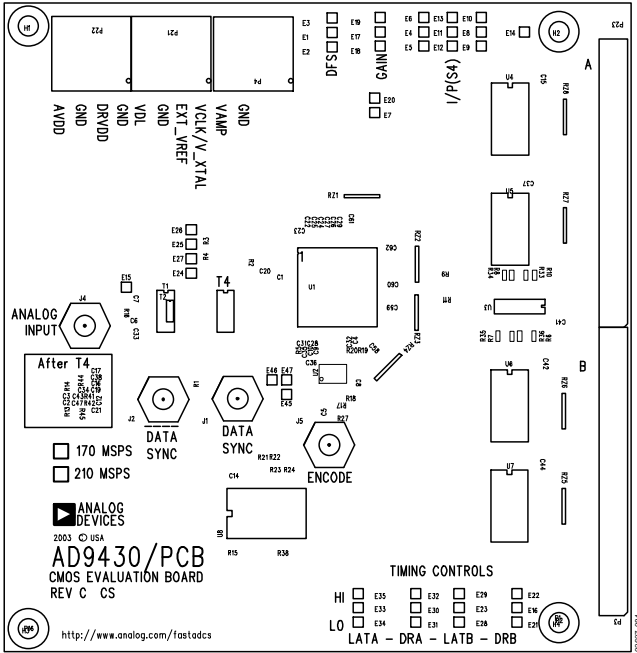

Figure 61. PCB Top-Side Silkscreen

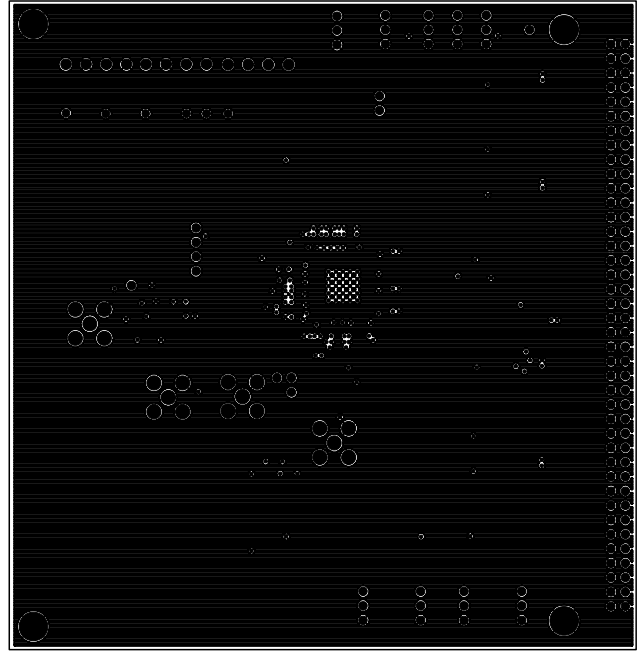

Figure 63. PCB Ground Layer

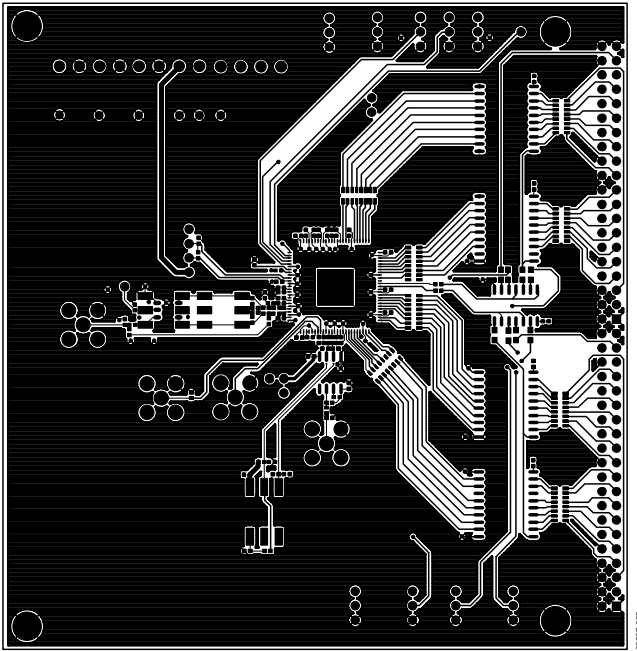

Figure 62. PCB Top-Side Copper

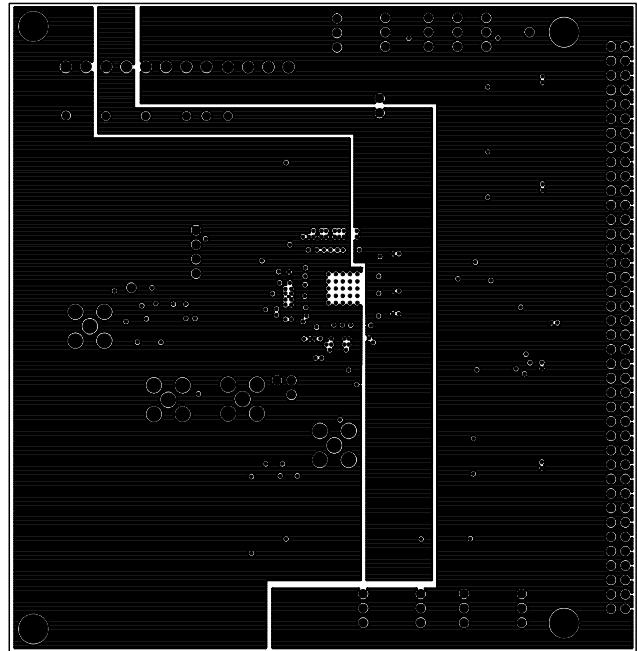

Figure 64. PCB Split Power Plane

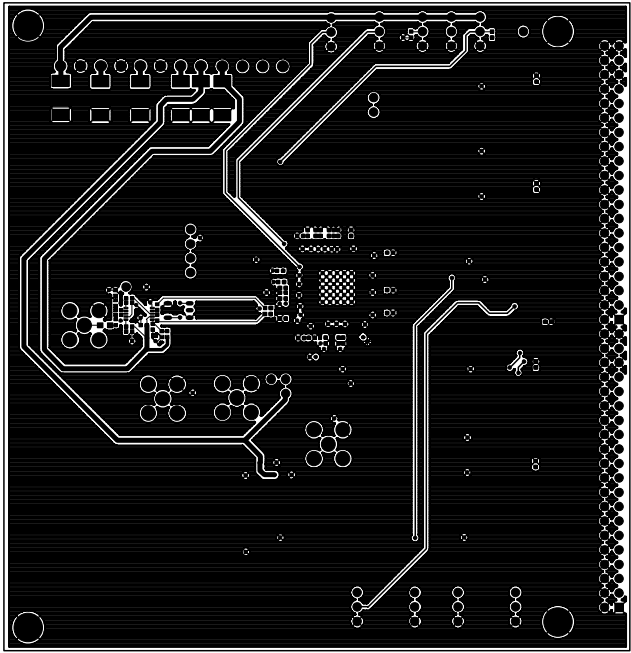

Figure 65. PCB Bottom-Side Copper

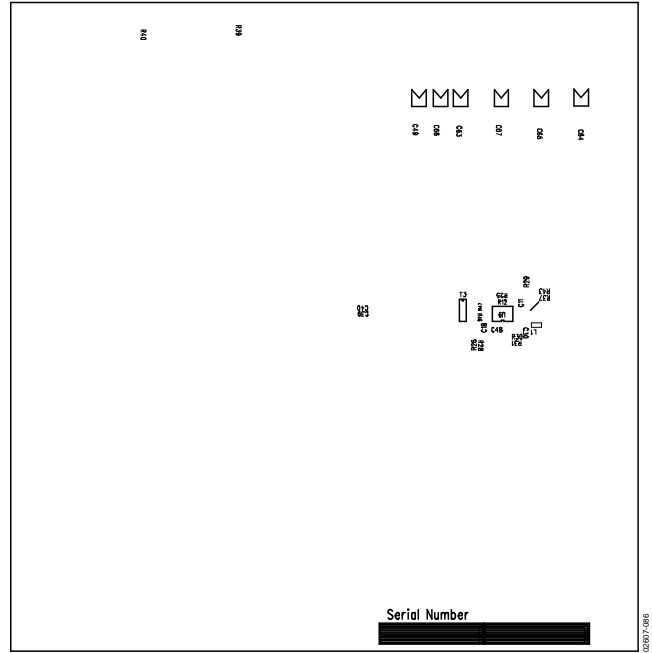

Figure 66. PCB Bottom-Side Silkscreen

## EVALUATION BOARD, LVDS MODE

The AD9430 evaluation board offers an easy way to test the AD9430 in LVDS mode. (The board is also compatible with the AD9411.) It requires a clock source, an analog input signal, and a 3.3 V power supply. The clock source is buffered on the board to provide the clocks for the ADC, latches, and a data-ready signal. The digital outputs and output clocks are available at a 40-pin connector, P23. The board has several different modes of operation and is shipped in the following configurations:

- Offset binary
- Internal voltage reference
- Full-scale adjust = low

Note that the AD9430 LVDS evaluation board does not interface directly with the standard Analog Devices dual-channel data capture board (HSC-ADC-EVAL-DC). An LVDS-to-CMOS translation board is required and is available from Analog Devices. (No translation board is required for the AD9430 CMOS evaluation board.)

### POWER CONNECTOR

Power is supplied to the board via a detachable 8-lead power strip (two 4-pin blocks). In Table 12, VCC, DRVDD, and VDL are the minimum required power connections, and the LVEL16 clock buffer can be powered from VCC or VDL at the E47 jumper.

**Table 12. Power Connector, LVDS Mode**

VCC 3.3 V	Analog supply for ADC (350 mA)
DRVDD 3.3 V	Output supply for ADC (50 mA)
VDL 3.3 V	Supply for support logic
EXT_VREF	Optional external reference input

### ANALOG INPUTS

The evaluation board accepts a 1.3 V p-p analog input signal centered at ground at SMB Connector J4. This signal is terminated to ground through 50  $\Omega$  by R16. The input can be alternatively terminated at the T1 transformer secondary by R13 and R14. T1 is a wideband RF transformer providing the single-ended-to-differential conversion, allowing the ADC to be driven differentially and minimizing even-order harmonics. An optional second transformer, T2, can be placed following T1 if desired. This provides some performance advantage (~1 to 2 dB) for high analog input frequencies (>100 MHz). If T2 is placed, two shorting traces at the pads need to be cut. The analog signal can be low-pass filtered by R41, C12 and R42, and C13 at the ADC input. A wideband differential amplifier (AD8351) can be configured on the PCB for dc-coupled applications. Remove C6, C15, and C30 to prevent transformer loading of the amp. See Figure 67, Figure 68, and Figure 69 for more information.

### GAIN

Full scale is set at E17 to E19, E17 to E18 sets S5 low, full scale = 1.5 V differential; E17 to E19 sets S5 high, full scale = 0.75 V differential. Best performance is obtained at 1.5 V full scale.

### CLOCK

The CLOCK input is terminated to ground through a 50  $\Omega$  resistor at SMB connector J5. The input is ac coupled to a high speed differential receiver (LVEL16) that provides the required low jitter, fast edge rates needed for optimum performance. J5 input should be >0.5 V p-p. Power to the LVEL16 is set at Jumper E47. E47 to E45 powers the buffer from AVDD; E47 to E46 powers the buffer from VCLK/V\_XTAL (not in Table 11).

### VOLTAGE REFERENCE

The AD9430 has an internal 1.23 V voltage reference. The ADC uses the internal reference as the default when jumpers E24 to E27 and E25 to E26 are left open. The full scale can be increased by placing optional resistor R3. The required value varies with the process and needs to be tuned for the specific application. Full scale can similarly be reduced by placing R4; tuning is required here as well. An external reference can be used by shorting the SENSE pin to 3.3 V (place jumper E26 to E25). Jumper E27 to E24 connects the ADC VREF pin to the EXT\_VREF pin at the power connector.

### DATA FORMAT SELECT

Data format select (DFS) sets the output data format of the ADC. Setting DFS low (E1 to E2) sets the output format to be offset binary; setting DFS high (E1 to E3) sets the output to twos complement.

### DATA OUTPUTS

The ADC LVDS digital outputs are routed directly to the connector at the card edge. Resistor pads have been placed at the output connector to allow for termination if the connector receiving logic does not have the required differential termination for the data bits and DCO. Each output trace pair should be terminated differentially at the far end of the line with a single 100  $\Omega$  resistor.

### CRYSTAL OSCILLATOR

An optional crystal oscillator can be placed on the board to serve as a clock source for the PCB. Power to the oscillator is through the VDL pin at the power connector. If an oscillator is used, ensure proper termination for best results. The board has been tested with a Valpey Fisher VF561 and a Vectron JN00158-163.84.

Table 13. LVDS PCB Evaluation Board Bill of Material

No.	Quantity	Reference Designator	Device	Package	Value	Comment
1	33	C1, C4–C11, C15–C17, C19–C32, C35, C36, C58–C62 C3, C18, C39, C40	Capacitors	0603	0.1 $\mu$ F	C3, C18, C39, C40 not placed
2	4	C33, C34, C37, C38	Capacitor	0402	0.1 $\mu$ F	C33, C34, C37, C38 not placed
3	4	C63–C66	Capacitor	TAJD CAPL	10 $\mu$ F	
4	1	C2	Capacitor	0603	10 pF	C2 not placed
5	2	C12, C13	Capacitor	0603	20 pF	C12, C13 not placed
6	2	J4, J5	Jacks	SMB		
7	2	P21, P22	Power connectors Top	25.602.5453.0 Wieland		
8	2	P21, P22	Power connectors Posts	Z5.531.3425.0 Wieland		
9	1	P23	40-pin right-angle connector	Digi-Key S2131-20-ND		
10	16	R1, R6–R12, R15, R31–R37	Resistor	0402	100 $\Omega$	R1, R6–R12, R15, R31–37 Not placed
11	1	R2	Resistor	0603	3.8 k $\Omega$	
12	3	R5, R16, R27	Resistor	0603	50 $\Omega$	
13	2	R17, R18	Resistor	0603	510 $\Omega$	
14	2	R19, R20	Resistor	0603	150 $\Omega$	
15	2	R29, R30	Resistor	0603	1 k $\Omega$	
16	2	R41, R42	Resistor	0603	25 $\Omega$	
17	2	R3, R4	Resistor	0603	3.8 k $\Omega$	
18	2	R13, R14	Resistor	0603	25 $\Omega$	R13, R14 not placed
19	6	R22, R23, R24, R25, R26, R28	Resistor	0603	100 $\Omega$	R22, R23, R24, R25, R26, R28 not placed
20	4	R39, R40, R45, R47	Resistor	0402	25 $\Omega$	R39, R40, R45, R47 not placed
21	2	R43, R44	Resistor	0402	10 k $\Omega$	R43, R44 not placed
22	1	R46	Resistor	0402	1.2 k $\Omega$	R46 not placed
23	3	R38, R48, R49	Resistor	0402	25 $\Omega$	R38, R48, R49 not placed
24	2	R50, R51	Resistor	0402	1 k $\Omega$	R50, R51 not placed
25	1	T1 T2	RF transformer	Mini-Circuits ADT1-1WT		T2 not placed
26	1	U2	RF amp	AD8351		
27	1	U9	Optional crystal oscillator	JN00158 or VF561		
28	1	U1	AD9430	TQFP-100		
29	1	U3	MC100LVEL16	SO8NB		

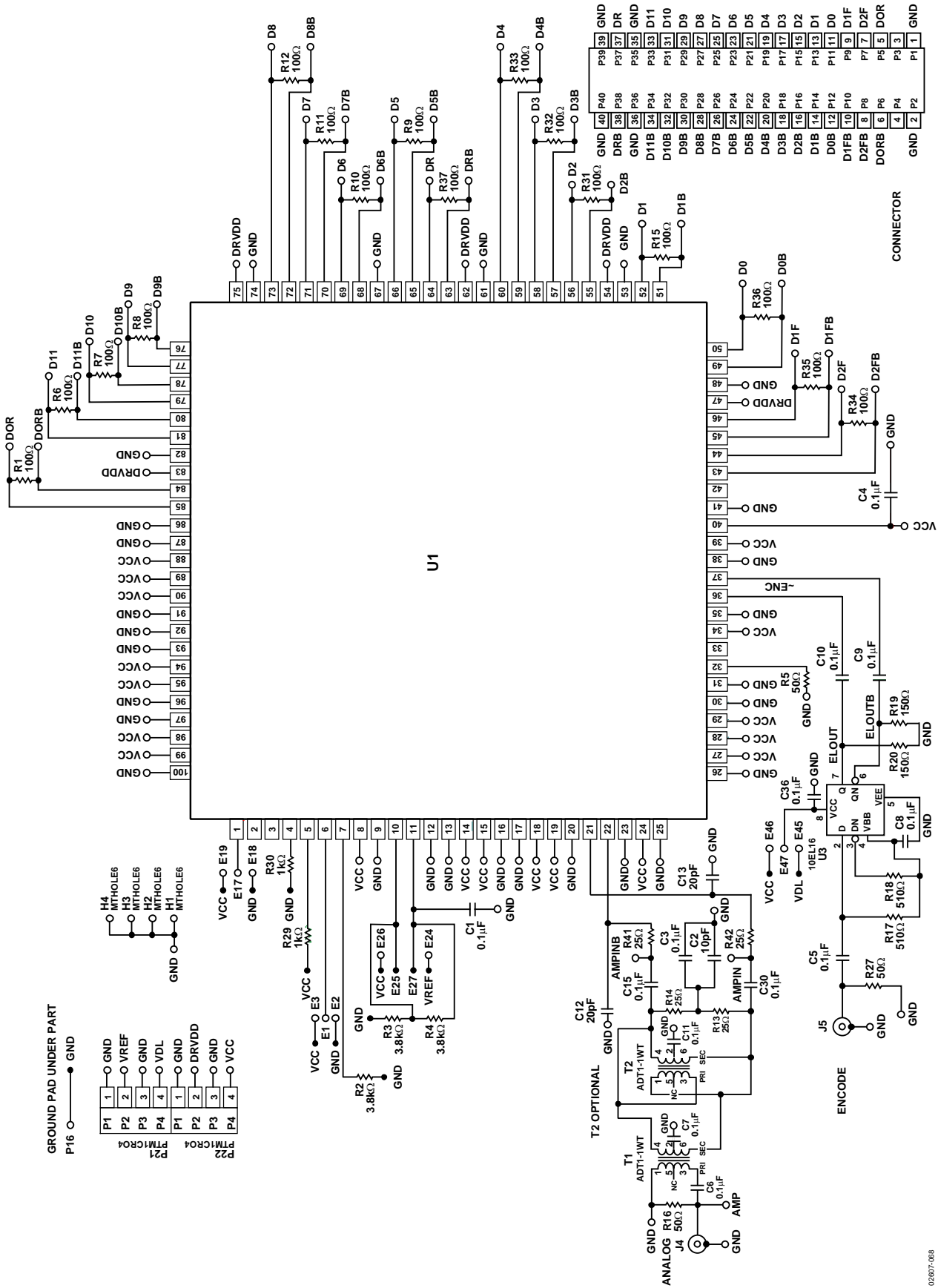
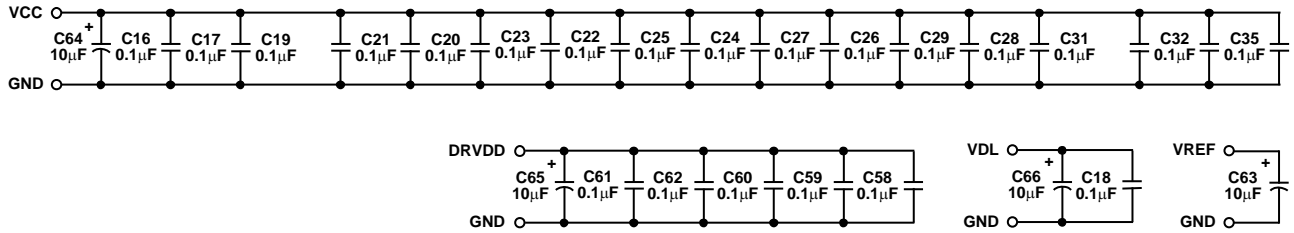

Figure 67. Evaluation Board Schematic—LVDS



TO USE VF561 CRYSTAL

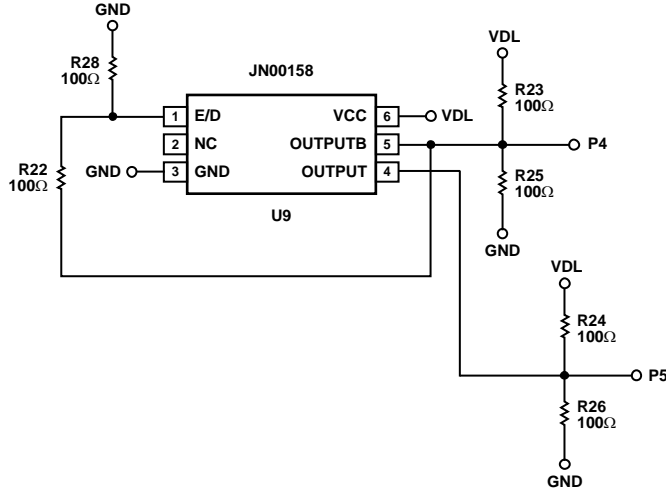

Figure 68. Evaluation Board Schematic—LVDS (continued)

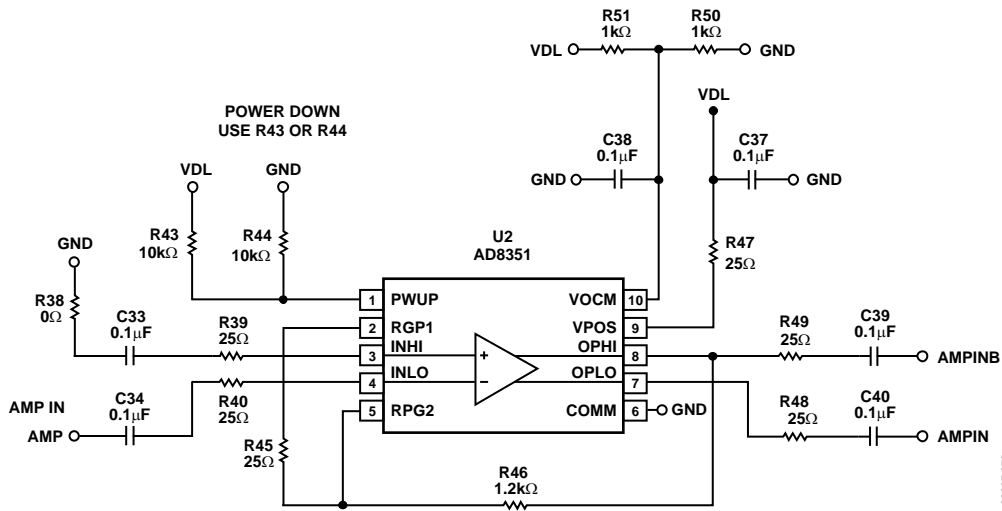

Figure 69. Evaluation Board Schematic—LVDS (continued)

# AD9430

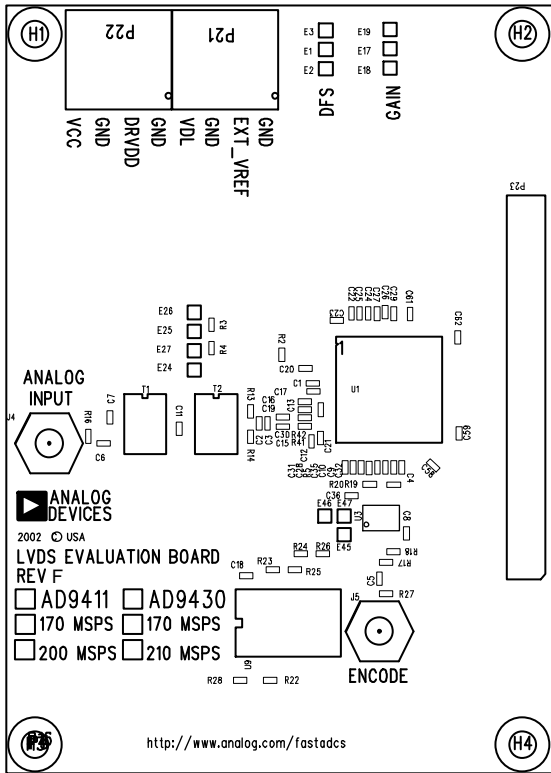

Figure 70. PCB Top-Side Silkscreen—LVDS

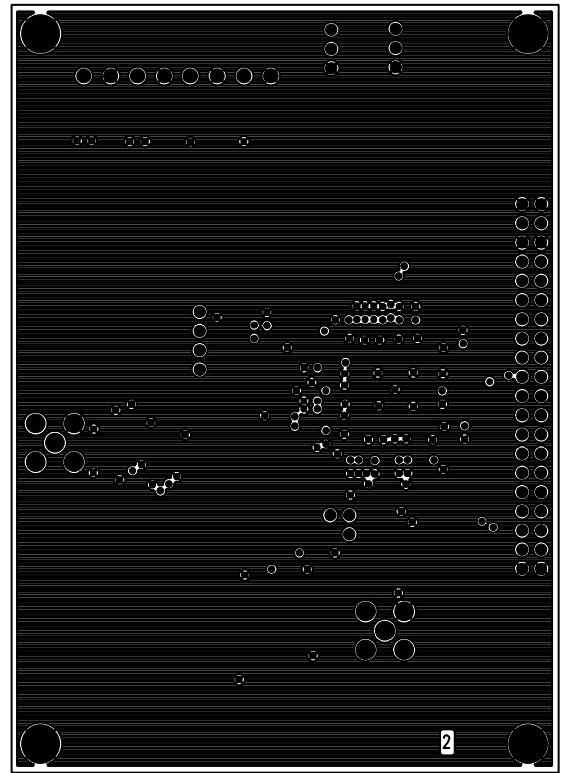

Figure 72. PCB Ground Layer—LVDS

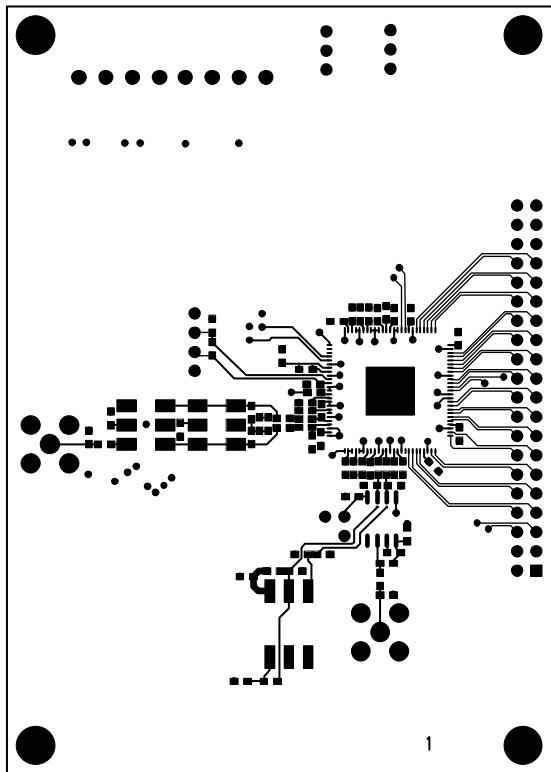

Figure 71. PCB Top-Side Copper—LVDS

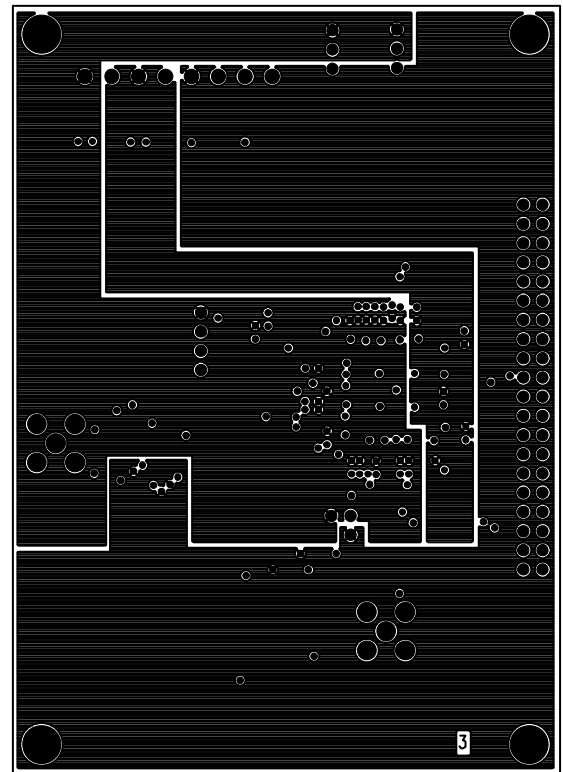

Figure 73. PCB Split Power Plane—LVDS



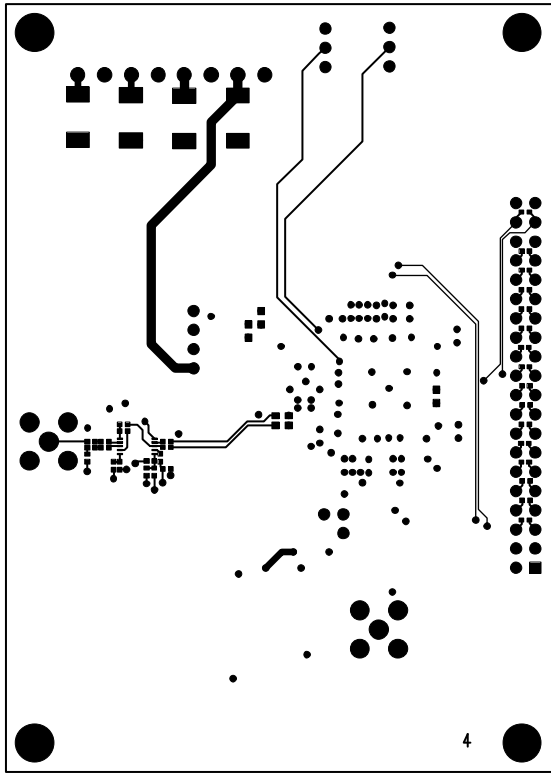

Figure 74. PCB Bottom-Side Copper—LVDS

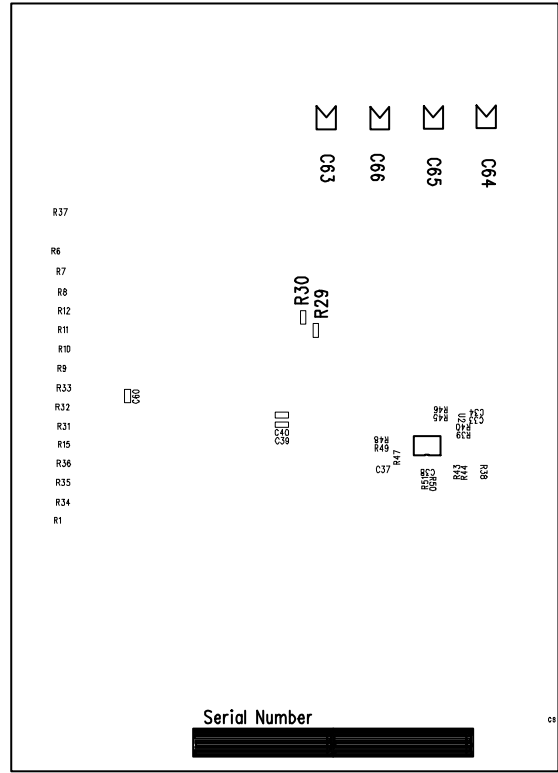
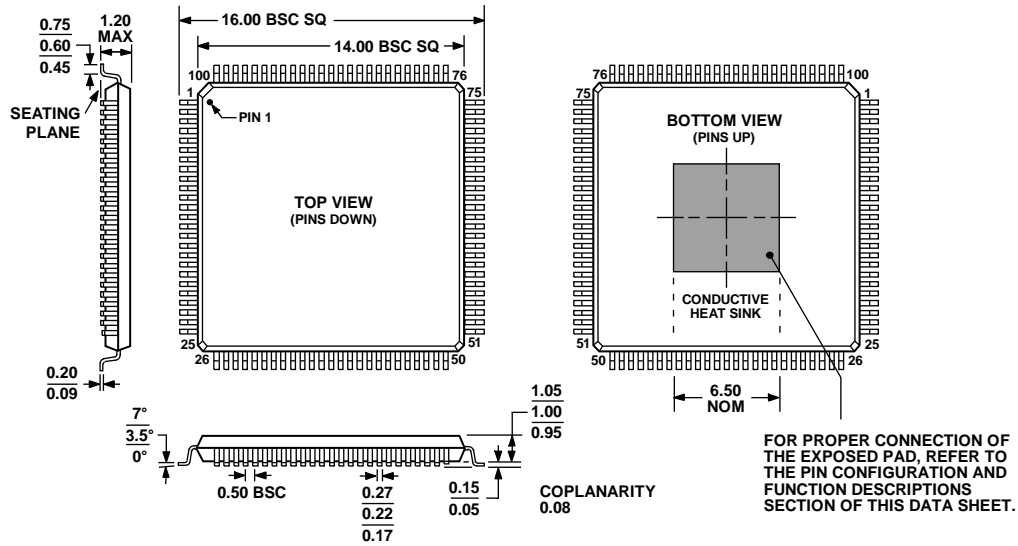

Figure 75. PCB Bottom-Side Silkscreen—LVDS

## OUTLINE DIMENSIONS



COMPLIANT TO JEDEC STANDARDS MS-026-AED-HD

Figure 76. 100-Lead Thin Quad Flat Package, Exposed Pad [TQFP\_EP] (SV-100-1)  
Dimensions shown in millimeters

021809-A

## ORDERING GUIDE

Model <sup>1</sup>	Temperature Range	Package Description	Package Option
AD9430BSV-170	-40°C to +85°C	100-Lead Thin Quad Flat Package, Exposed Pad (TQFP_EP)	SV-100-1
AD9430BSVZ-170	-40°C to +85°C	100-Lead Thin Quad Flat Package, Exposed Pad (TQFP_EP)	SV-100-1
AD9430BSV-210	-40°C to +85°C	100-Lead Thin Quad Flat Package, Exposed Pad (TQFP_EP)	SV-100-1
AD9430BSVZ-210	-40°C to +85°C	100-Lead Thin Quad Flat Package, Exposed Pad (TQFP_EP)	SV-100-1

<sup>1</sup> Z = RoHS Compliant Part.

**NOTES**

**AD9430**

**NOTES**