

10-Bit, 500ksps ADCs in MSOP with Auto Shutdown

FEATURES

- **8-Pin MSOP and SO Packages**
- 10-Bit Resolution at 500ksps
- Single Supply: 5V or 3V
- Low Power at Full Speed:
 - 25mW Typ at 5V
 - 2.2mW Typ at 2.7V
- Auto Shutdown Reduces Power Linearly at Lower Sample Rates
- 10-Bit Upgrade to 8-Bit LTC1196/LTC1198
- SPI and MICROWIRE™ Compatible Serial I/O
- **Low Cost**

APPLICATIONS

- High Speed Data Acquisition
- Portable or Compact Instrumentation
- Low Power or Battery-Operated Instrumentation

DESCRIPTION

The LTC®1197/LTC1197L/LTC1199/LTC1199L are 10-bit A/D converters with sampling rates up to 500kHz. They have 2.7V (L) and 5V versions and are offered in 8-pin MSOP and SO packages. Power dissipation is typically only 2.2mW at 2.7V (25mW at 5V) during full speed operation. The automatic power down reduces supply current linearly as sample rate is reduced. These 10-bit, switched-capacitor, successive approximation ADCs include a sample-and-hold. The LTC1197/LTC1197L have a differential analog input with an adjustable reference pin. The LTC1199/LTC1199L offer a software-selectable 2-channel MUX.

The 3-wire serial I/O, MSOP and SO-8 packages, 2.7V operation and extremely high sample rate-to-power ratio make these ADCs ideal choices for compact, low power high speed systems.

These circuits can be used in ratiometric applications or with external references. The high impedance analog inputs and the ability to operate with reduced spans below 1V full scale (LTC1197/LTC1197L) allow direct connection to signal sources in many applications, eliminating the need for gain stages.

LT, LTC and LT are registered trademarks of Linear Technology Corporation. MICROWIRE is a trademark of National Semiconductor Corporation.

TYPICAL APPLICATION

Single 2.7V Supply, 250ksps, 10-Bit Sampling ADC

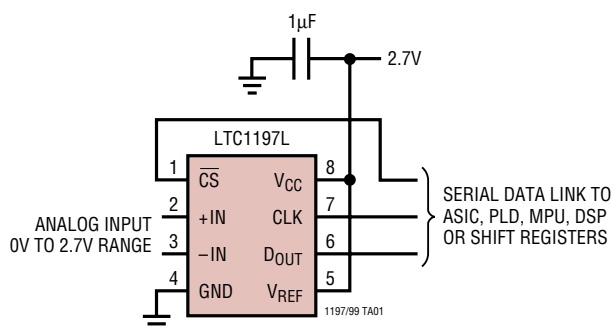

Supply Current vs Sampling Frequency

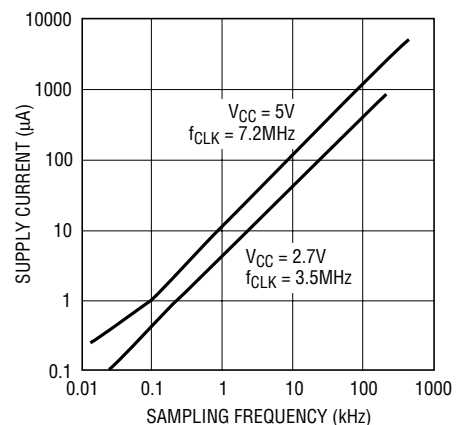

1197/99 G03

LTC1197/LTC1197L LTC1199/LTC1199L

ABSOLUTE MAXIMUM RATINGS (Notes 1, 2)

Supply Voltage (V_{CC})	12V	Operating Temperature Range	
Voltage		LTC1197C/LTC1197LC	
Analog Input	GND – 0.3V to $V_{CC} + 0.3V$	LTC1199C/LTC1199LC	0°C to 70°C
Digital Input	GND – 0.3V to 12V	LTC1197I/LTC1197LI	
Digital Output	GND – 0.3V to $V_{CC} + 0.3V$	LTC1199I/LTC1199LI	–45°C to 85°C
Power Dissipation	500mW	Lead Temperature (Soldering, 10 sec)	300°C
Storage Temperature Range	–65°C to 150°C		

PACKAGE/ORDER INFORMATION

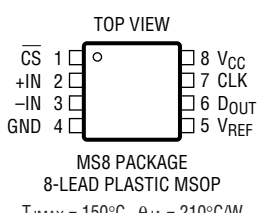
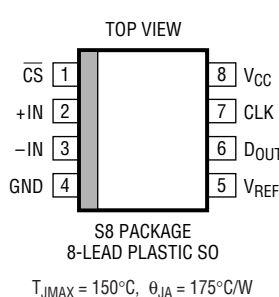
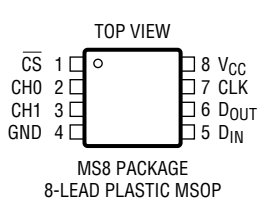
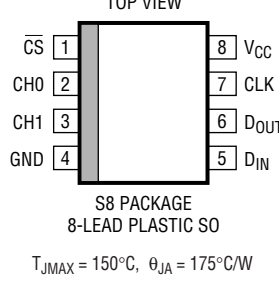
 <p>MS8 PACKAGE 8-LEAD PLASTIC MSOP $T_{JMAX} = 150^{\circ}C, \theta_{JA} = 210^{\circ}C/W$</p>	ORDER PART NUMBER	 <p>S8 PACKAGE 8-LEAD PLASTIC SO $T_{JMAX} = 150^{\circ}C, \theta_{JA} = 175^{\circ}C/W$</p>	ORDER PART NUMBER
	LTC1197CMS8 LTC1197IMS8 LTC1197LCMS8 LTC1197LIMS8		LTC1197CS8 LTC1197IS8 LTC1197LCS8 LTC1197LIS8
	MS8 PART MARKING		S8 PART MARKING
	LTKV LTBL LTKW LTJA		1197 1197L 1197I 1197LI
 <p>MS8 PACKAGE 8-LEAD PLASTIC MSOP $T_{JMAX} = 150^{\circ}C, \theta_{JA} = 210^{\circ}C/W$</p>	ORDER PART NUMBER	 <p>S8 PACKAGE 8-LEAD PLASTIC SO $T_{JMAX} = 150^{\circ}C, \theta_{JA} = 175^{\circ}C/W$</p>	ORDER PART NUMBER
	LTC1199CMS8 LTC1199IMS8 LTC1199LCMS8 LTC1199LIMS8		LTC1199CS8 LTC1199IS8 LTC1199LCS8 LTC1199LIS8
	MS8 PART MARKING		S8 PART MARKING
	LTFL LTCM LTSW LTWC		1199 1199L 1199I 1199LI

Consult factory for parts specified with wider operating temperature ranges.

RECOMMENDED OPERATING CONDITIONS

The ● denotes the specifications which apply over the full operating temperature range, otherwise specifications are at $T_A = 25^{\circ}C$.

SYMBOL	PARAMETER	CONDITIONS	LTC1197			LTC1199			UNITS
			MIN	TYP	MAX	MIN	TYP	MAX	
V_{CC}	Supply Voltage		4		9	4		6	V
$V_{CC} = 5V$ Operation									
f_{CLK}	Clock Frequency		●	0.05	7.2	0.05		7.2	MHz
t_{CYC}	Total Cycle Time			14			16		CLK
t_{SMPL}	Analog Input Sampling Time			1.5			1.5		CLK
t_{hCS}	Hold Time \overline{CS} Low After Last CLK↑			13			13		ns

RECOMMENDED OPERATING CONDITIONS

The ● denotes the specifications which apply over the full operating temperature range, otherwise specifications are at $T_A = 25^\circ\text{C}$.

SYMBOL	PARAMETER	CONDITIONS	LTC1197			LTC1199			UNITS
			MIN	TYP	MAX	MIN	TYP	MAX	
$V_{CC} = 5V$ Operation									
$t_{su\overline{CS}}$	Setup Time $\overline{CS}\downarrow$ Before First $CLK\uparrow$ (See Figures 1, 2)		26			26			ns
t_{hDI}	Hold Time D_{IN} After $CLK\uparrow$	LTC1199				26			ns
t_{suDI}	Setup Time D_{IN} Stable Before $CLK\uparrow$	LTC1199				26			ns
t_{WHCLK}	CLK High Time	$f_{CLK} = f_{CLK(MAX)}$	40%			40%			$1/f_{CLK}$
t_{WLCLK}	CLK Low Time	$f_{CLK} = f_{CLK(MAX)}$	40%			40%			$1/f_{CLK}$
$t_{WH\overline{CS}}$	\overline{CS} High Time Between Data Transfer Cycles		32			32			ns
$t_{WL\overline{CS}}$	\overline{CS} Low Time During Data Transfer		13			15			CLK

SYMBOL	PARAMETER	CONDITIONS	LTC1197L			LTC1199L			UNITS
			MIN	TYP	MAX	MIN	TYP	MAX	
V_{CC}	Supply Voltage		2.7		4	2.7		4	V
$V_{CC} = 2.7V$ Operation									
f_{CLK}	Clock Frequency		● 0.01		3.5	0.01		3.5	MHz
t_{CYC}	Total Cycle Time		14			16			CLK
t_{SMPL}	Analog Input Sampling Time		1.5			1.5			CLK
$t_{h\overline{CS}}$	Hold Time \overline{CS} Low After Last $CLK\uparrow$		40			40			ns
$t_{su\overline{CS}}$	Setup Time $\overline{CS}\downarrow$ Before First $CLK\uparrow$ (See Figures 1, 2)		78			78			ns
t_{hDI}	Hold Time D_{IN} After $CLK\uparrow$	LTC1199L				78			ns
t_{suDI}	Setup Time D_{IN} Stable Before $CLK\uparrow$	LTC1199L				78			ns
t_{WHCLK}	CLK High Time	$f_{CLK} = f_{CLK(MAX)}$	40%			40%			$1/f_{CLK}$
t_{WLCLK}	CLK Low Time	$f_{CLK} = f_{CLK(MAX)}$	40%			40%			$1/f_{CLK}$
$t_{WH\overline{CS}}$	\overline{CS} High Time Between Data Transfer Cycles		96			96			ns
$t_{WL\overline{CS}}$	\overline{CS} Low Time During Data Transfer		13			15			CLK

CONVERTER AND MULTIPLEXER CHARACTERISTICS

The ● denotes the specifications which apply over the full operating temperature range, otherwise specifications are at $T_A = 25^\circ\text{C}$. $V_{CC} = 5V$, $V_{REF} = 5V$, $f_{CLK} = f_{CLK(MAX)}$ as defined in Recommended Operating Conditions, unless otherwise noted.

PARAMETER	CONDITIONS		LTC1197			LTC1199			UNITS
			MIN	TYP	MAX	MIN	TYP	MAX	
Offset Error		●			±2			±2	LSB
Linearity Error	(Note 3)	●			±1			±1	LSB
Gain Error		●			±4			±4	LSB
No Missing Codes Resolution		●	10			10			Bits
Analog Input Range			-0.05V to $V_{CC} + 0.05V$						V
Reference Input Range	LTC1197, $V_{CC} \leq 6V$		0.2		$V_{CC} + 0.05V$				V
	LTC1197, $V_{CC} > 6V$		0.2		6				V
Analog Input Leakage Current	(Note 4)	●			±1			±1	μA

CONVERTER AND MULTIPLEXER CHARACTERISTICS

The ● denotes the specifications which apply over the full operating temperature range, otherwise specifications are at $T_A = 25^\circ\text{C}$. $V_{CC} = 2.7\text{V}$, $V_{REF} = 2.5\text{V}$ (LTC1197L), $f_{CLK} = f_{CLK(MAX)}$ as defined in Recommended Operating Conditions, unless otherwise noted.

PARAMETER	CONDITIONS		LTC1197L			LTC1199L			UNITS
			MIN	TYP	MAX	MIN	TYP	MAX	
Offset Error		●			±2			±2	LSB
Linearity Error	(Note 3)	●			±1			±1	LSB
Gain Error		●			±4			±4	LSB
No Missing Codes Resolution		●	10			10			Bits
Analog Input Range			-0.05V to $V_{CC} + 0.05\text{V}$						V
Reference Input Range	LTC1197L		0.2		$V_{CC} + 0.05\text{V}$				V
Analog Input Leakage Current	(Note 4)	●			±1			±1	µA

DYNAMIC ACCURACY

$V_{CC} = 5\text{V}$, $V_{REF} = 5\text{V}$, $f_{CLK} = f_{CLK(MAX)}$ as defined in Recommended Operating Conditions, unless otherwise noted.

SYMBOL	PARAMETER	CONDITIONS	LTC1197			LTC1199			UNITS
			MIN	TYP	MAX	MIN	TYP	MAX	
S/(N + D)	Signal-to-Noise Plus Distortion Ratio	100kHz Input Signal		60			60		dB
THD	Total Harmonic Distortion First 5 Harmonics	100kHz Input Signal		-64			-64		dB
	Peak Harmonic or Spurious Noise	100kHz Input Signal		-68			-68		dB
IMD	Intermodulation Distortion	$f_{IN1} = 97.046\text{kHz}$, $f_{IN2} = 102.905\text{kHz}$ 2nd Order Terms 3rd Order Terms		-65 -70			-65 -70		dB dB

$V_{CC} = 2.7\text{V}$, $V_{REF} = 2.5\text{V}$, $f_{CLK} = f_{CLK(MAX)}$ as defined in Recommended Operating Conditions, unless otherwise noted.

SYMBOL	PARAMETER	CONDITIONS	LTC1197L			LTC1199L			UNITS
			MIN	TYP	MAX	MIN	TYP	MAX	
S/(N + D)	Signal-to-Noise Plus Distortion Ratio	50kHz Input Signal		58			58		dB
THD	Total Harmonic Distortion First 5 Harmonics	50kHz Input Signal		-60			-60		dB
	Peak Harmonic or Spurious Noise	50kHz Input Signal		-63			-63		dB
IMD	Intermodulation Distortion	$f_{IN1} = 48.5\text{kHz}$, $f_{IN2} = 51.5\text{kHz}$ 2nd Order Terms 3rd Order Terms		-60 -65			-60 -65		dB dB

DIGITAL AND DC ELECTRICAL CHARACTERISTICS The ● denotes the specifications which apply over the full operating temperature range, otherwise specifications are at $T_A = 25^\circ\text{C}$. $V_{CC} = 5\text{V}$, $V_{REF} = 5\text{V}$, unless otherwise noted.

SYMBOL	PARAMETER	CONDITIONS	LTC1197			LTC1199			UNITS
			MIN	TYP	MAX	MIN	TYP	MAX	
V_{IH}	High Level Input Voltage	$V_{CC} = 5.25\text{V}$	●	2.4			2.4		V
V_{IL}	Low Level Input Voltage	$V_{CC} = 4.75\text{V}$	●			0.8		0.8	V
I_{IH}	High Level Input Current	$V_{IN} = V_{CC}$	●			2.5		2.5	μA
I_{IL}	Low Level Input Current	$V_{IN} = 0\text{V}$	●			-2.5		-2.5	μA
V_{OH}	High Level Output Voltage	$V_{CC} = 4.75\text{V}$, $I_O = 10\mu\text{A}$	●	4.5	4.74		4.5	4.74	V
		$V_{CC} = 4.75\text{V}$, $I_O = 360\mu\text{A}$	●	2.4	4.72		2.4	4.72	V
V_{OL}	Low Level Output Voltage	$V_{CC} = 4.75\text{V}$, $I_O = 1.6\text{mA}$	●			0.4		0.4	V
I_{OZ}	Hi-Z Output Leakage	$\overline{CS} = \text{High}$	●			± 3		± 3	μA
I_{SOURCE}	Output Source Current	$V_{OUT} = 0\text{V}$				-25		-25	mA
I_{SINK}	Output Sink Current	$V_{OUT} = V_{CC}$				45		45	mA
I_{REF}	Reference Current (LTC1197)	$\overline{CS} = V_{CC}$	●	0.001	3				μA
		$f_{SMPL} = f_{SMPL(MAX)}$	●	0.5	1				mA
I_{CC}	Supply Current	$\overline{CS} = V_{CC}$	●	0.001	3		0.001	3	μA
		$f_{SMPL} = f_{SMPL(MAX)}$	●	4.5	8		5	8.5	mA
P_D	Power Dissipation	$f_{SMPL} = f_{SMPL(MAX)}$				22.5		25	mW

The ● denotes the specifications which apply over the full operating temperature range, otherwise specifications are at $T_A = 25^\circ\text{C}$. $V_{CC} = 2.7\text{V}$, $V_{REF} = 2.5\text{V}$, unless otherwise noted.

SYMBOL	PARAMETER	CONDITIONS	LTC1197L			LTC1199L			UNITS
			MIN	TYP	MAX	MIN	TYP	MAX	
V_{IH}	High Level Input Voltage	$V_{CC} = 3.6\text{V}$	●	1.9			1.9		V
V_{IL}	Low Level Input Voltage	$V_{CC} = 2.7\text{V}$	●			0.45		0.45	V
I_{IH}	High Level Input Current	$V_{IN} = V_{CC}$	●			2.5		2.5	μA
I_{IL}	Low Level Input Current	$V_{IN} = 0\text{V}$	●			-2.5		-2.5	μA
V_{OH}	High Level Output Voltage	$V_{CC} = 2.7\text{V}$, $I_O = 10\mu\text{A}$	●	2.3	2.60		2.3	2.60	V
		$V_{CC} = 2.7\text{V}$, $I_O = 360\mu\text{A}$	●	2.1	2.45		2.1	2.45	V
V_{OL}	Low Level Output Voltage	$V_{CC} = 2.7\text{V}$, $I_O = 400\mu\text{A}$	●			0.3		0.3	V
I_{OZ}	Hi-Z Output Leakage	$\overline{CS} = \text{High}$	●			± 3		± 3	μA
I_{SOURCE}	Output Source Current	$V_{OUT} = 0\text{V}$				-6.5		-6.5	mA
I_{SINK}	Output Sink Current	$V_{OUT} = V_{CC}$				11		11	mA
I_{REF}	Reference Current (LTC1197L)	$\overline{CS} = V_{CC}$	●	0.001	3.0				μA
		$f_{SMPL} = f_{SMPL(MAX)}$	●	0.250	0.5				mA
I_{CC}	Supply Current	$\overline{CS} = V_{CC}$	●	0.001	3		0.001	3	μA
		$f_{SMPL} = f_{SMPL(MAX)}$	●	0.8	2		0.8	2	mA
P_D	Power Dissipation	$f_{SMPL} = f_{SMPL(MAX)}$				2.2		2.2	mW

AC CHARACTERISTICS

The ● denotes the specifications which apply over the full operating temperature range, otherwise specifications are at $T_A = 25^\circ\text{C}$. $V_{CC} = 5\text{V}$, $V_{REF} = 5\text{V}$, $f_{CLK} = f_{CLK(MAX)}$ as defined in Recommended Operating Conditions, unless otherwise noted.

SYMBOL	PARAMETER	CONDITIONS	LTC1197			LTC1199			UNITS
			MIN	TYP	MAX	MIN	TYP	MAX	
t_{CONV}	Conversion Time (See Figures 1, 2)	●			1.4			1.4	μs
$f_{SMPL(MAX)}$	Maximum Sampling Frequency	●	500			450			kHz
t_{dDO}	Delay Time, $\text{CLK}\uparrow$ to D_{OUT} Data Valid	$C_{LOAD} = 20\text{pF}$ ●		68	78 100		68	78 100	ns ns
t_{dis}	Delay Time, $\overline{\text{CS}}\uparrow$ to D_{OUT} Hi-Z	●		75	150		75	150	ns
t_{en}	Delay Time, $\text{CLK}\downarrow$ to D_{OUT} Enabled	$C_{LOAD} = 20\text{pF}$ ●		40	68		40	68	ns
t_{hDO}	Time Output Data Remains Valid After $\text{CLK}\uparrow$	$C_{LOAD} = 20\text{pF}$ ●	15	55		15	55		ns
t_r	D_{OUT} Rise Time	$C_{LOAD} = 20\text{pF}$ ●		10	20		10	20	ns
t_f	D_{OUT} Fall Time	$C_{LOAD} = 20\text{pF}$ ●		10	20		10	20	ns
C_{IN}	Input Capacitance	Analog Input On Channel Analog Input Off Channel Digital Input		20 5 5			20 5 5		pF pF pF

The ● denotes the specifications which apply over the full operating temperature range, otherwise specifications are at $T_A = 25^\circ\text{C}$. $V_{CC} = 2.7\text{V}$, $V_{REF} = 2.5\text{V}$, $f_{CLK} = f_{CLK(MAX)}$ as defined in Recommended Operating Conditions, unless otherwise noted.

SYMBOL	PARAMETER	CONDITIONS	LTC1197L			LTC1199L			UNITS
			MIN	TYP	MAX	MIN	TYP	MAX	
t_{CONV}	Conversion Time (See Figures 1, 2)	●			2.9			2.9	μs
$f_{SMPL(MAX)}$	Maximum Sampling Frequency	●	250			210			kHz
t_{dDO}	Delay Time, $\text{CLK}\uparrow$ to D_{OUT} Data Valid	$C_{LOAD} = 20\text{pF}$ ●		130	180 250		130	180 250	ns ns
t_{dis}	Delay Time, $\overline{\text{CS}}\uparrow$ to D_{OUT} Hi-Z	●		120	250		120	250	ns
t_{en}	Delay Time, $\text{CLK}\downarrow$ to D_{OUT} Enabled	$C_{LOAD} = 20\text{pF}$ ●		100	200		100	200	ns
t_{hDO}	Time Output Data Remains Valid After $\text{CLK}\uparrow$	$C_{LOAD} = 20\text{pF}$ ●	30	120		30	120		ns
t_r	D_{OUT} Rise Time	$C_{LOAD} = 20\text{pF}$ ●		15	40		15	40	ns
t_f	D_{OUT} Fall Time	$C_{LOAD} = 20\text{pF}$ ●		15	40		15	40	ns
C_{IN}	Input Capacitance	Analog Input On Channel Analog Input Off Channel Digital Input		20 5 5			20 5 5		pF pF pF

Note 1: Absolute Maximum Ratings are those values beyond which the life of a device may be impaired.

Note 2: All voltage values are with respect to GND.

Note 3: Integral nonlinearity is defined as deviation of a code from a straight line passing through the actual endpoints of the transfer curve. The deviation is measured from the center of the quantization band.

Note 4: Channel leakage current is measured after the channel selection.

TYPICAL PERFORMANCE CHARACTERISTICS

Supply Current vs Clock Rate*

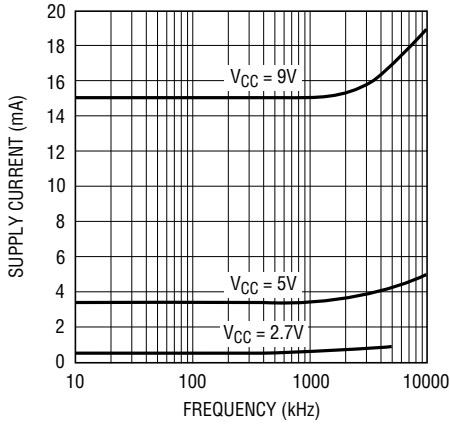

1197/99 G01

Supply Current vs Supply Voltage

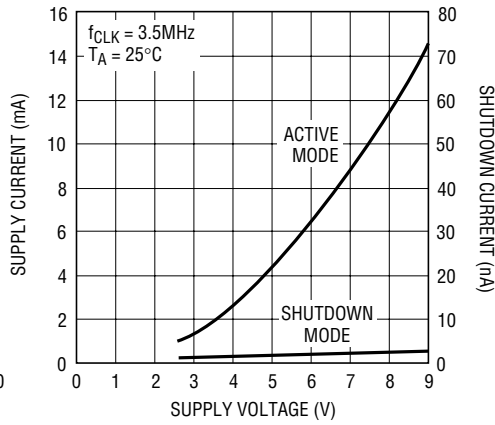

1197/99 G02

Supply Current vs Sampling Frequency

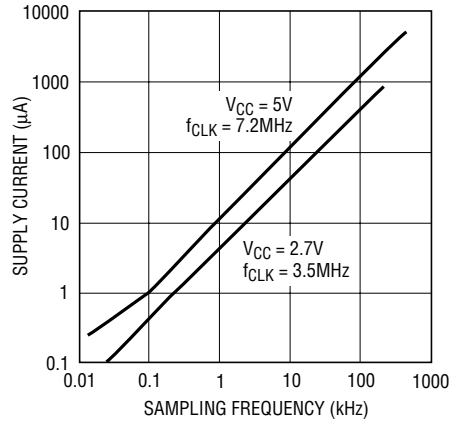

1197/99 G03

INL Plot

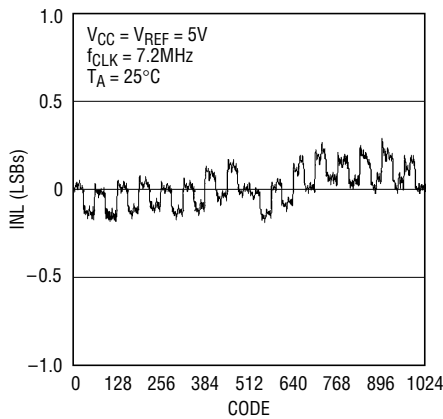

1197/99 G04

DNL Plot

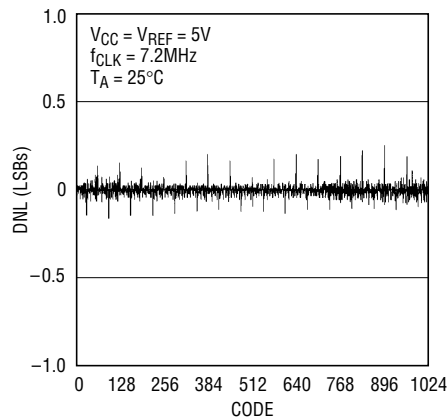

1197/99 G02

LTC1197 4096 Point FFT

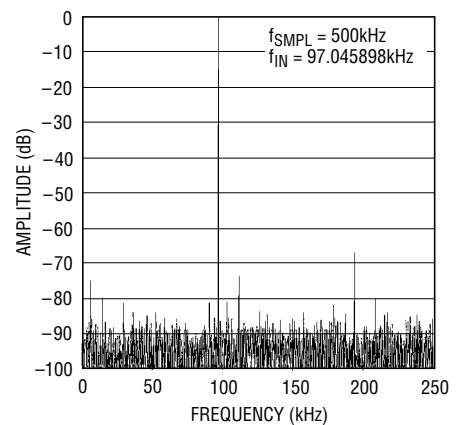

1197/99 G06

ENOBs vs Frequency

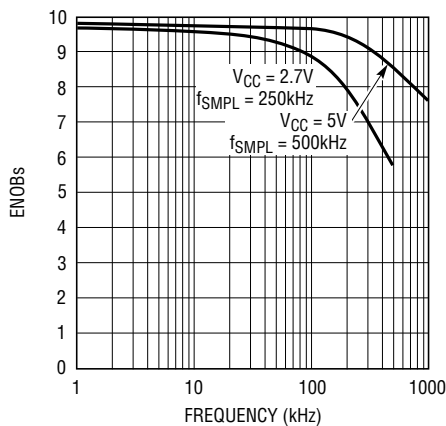

1197/99 G07

THD vs Frequency

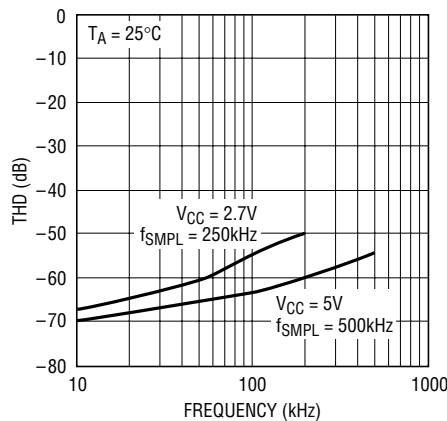

1197/99 G08

Intermodulation Distortion Plot

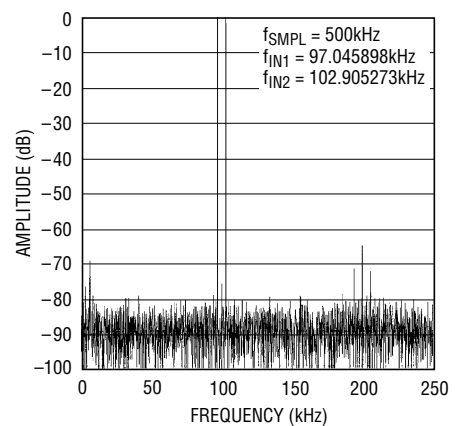

1197/99 G09

*Part is continuously sampling, spending only a minimum amount of time in shutdown.

TYPICAL PERFORMANCE CHARACTERISTICS

LTC1197L Change in Linearity vs Supply Voltage

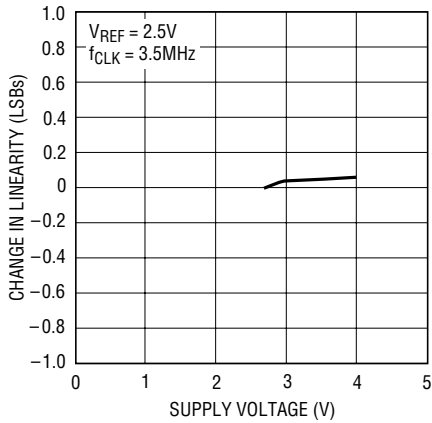

1197/99 G10

LTC1197L Change in Offset vs Supply Voltage

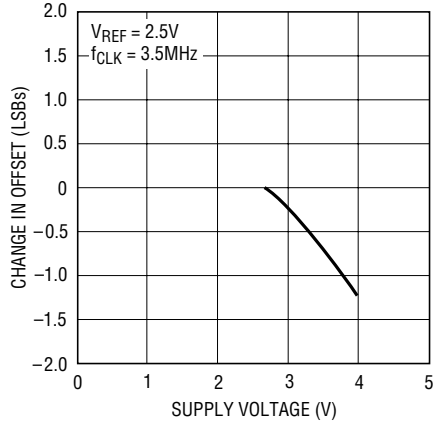

1197/99 G11

LTC1197L Change in Gain Error vs Supply Voltage

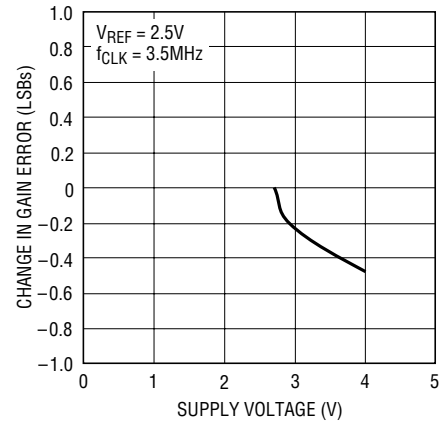

1197/99 G12

LTC1197 Change in Linearity vs Supply Voltage

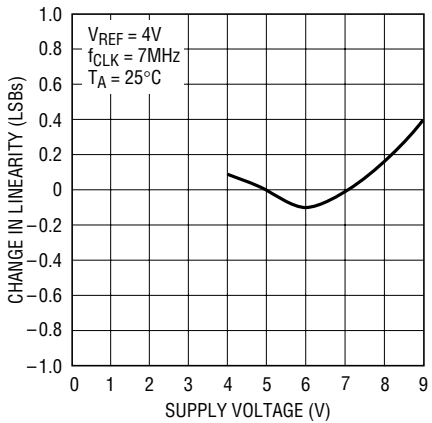

1197/99 G13

LTC1197 Change in Offset vs Supply Voltage

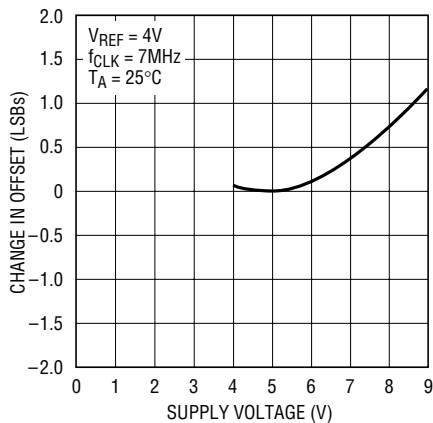

1197/99 G14

LTC1197 Change in Gain Error vs Supply Voltage

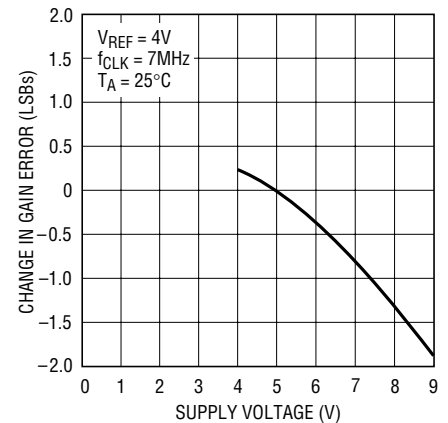

1197/99 G15

LTC1197 Linearity Error vs Reference Voltage

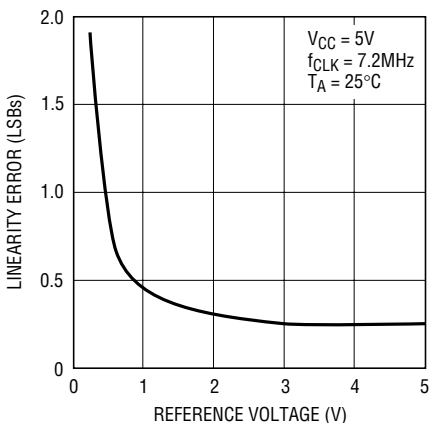

1197/99 F16

LTC1197 Offset Error vs Reference Voltage

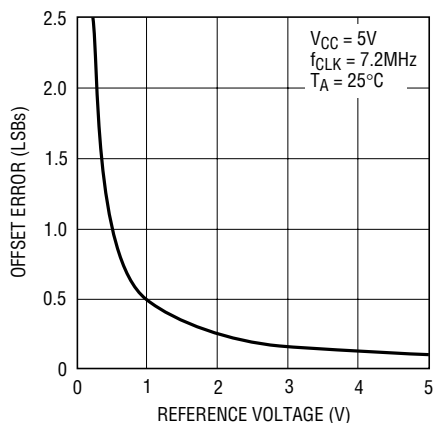

1197/99 G17

LTC1197 Gain Error vs Reference Voltage

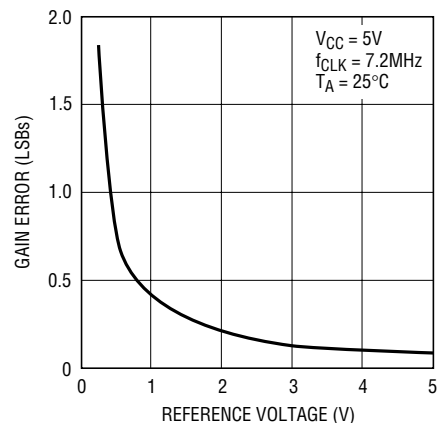

1197/99 F18

TYPICAL PERFORMANCE CHARACTERISTICS

Linearity vs Temperature

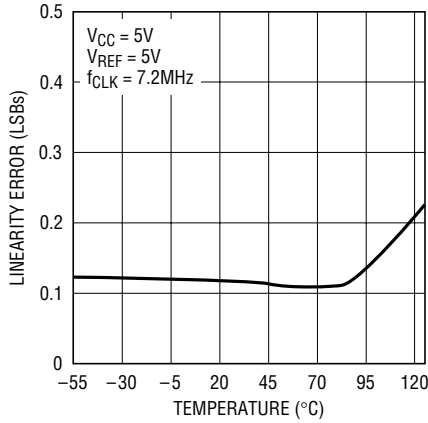

1197/99 G19

Offset vs Temperature

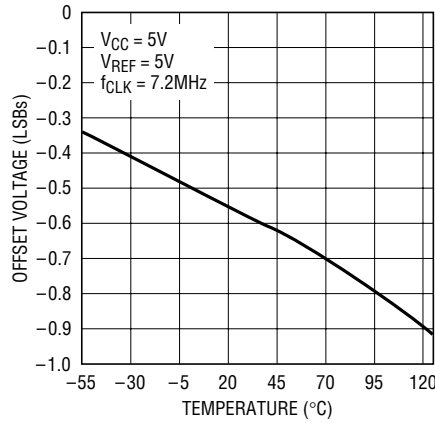

1197/99 G20

Gain Error vs Temperature

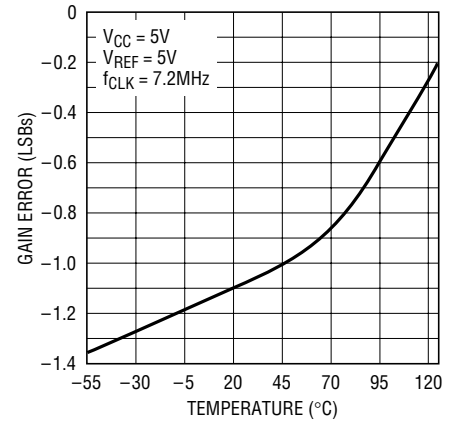

1197/99 G21

Minimum Clock Frequency for 0.1LSB Error* vs Temperature

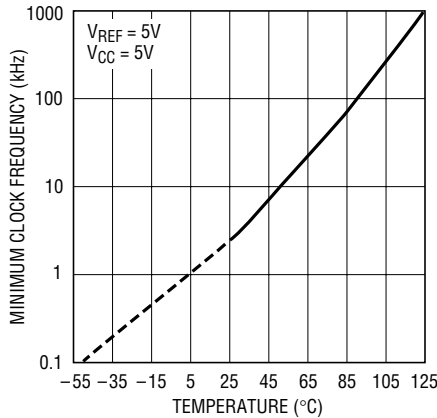

1197/99 G22

Digital Input Threshold vs Supply Voltage

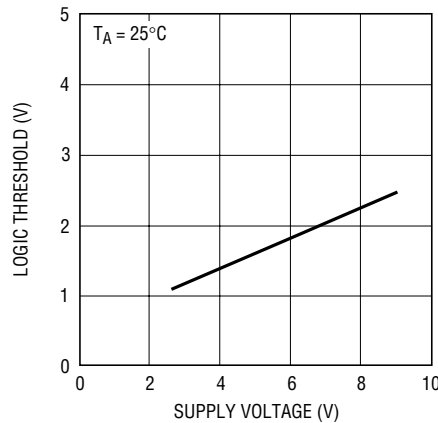

1197/99 G23

Input Channel Leakage Current vs Temperature

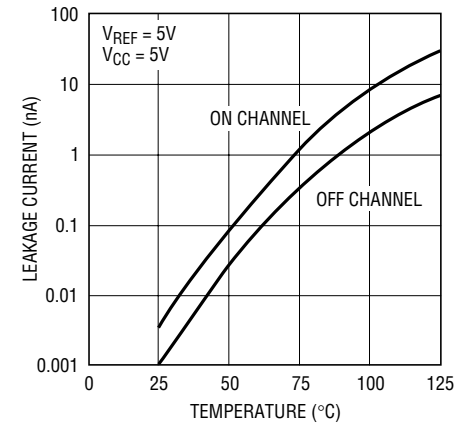

1197/99 G24

Acquisition Time vs Source Resistance

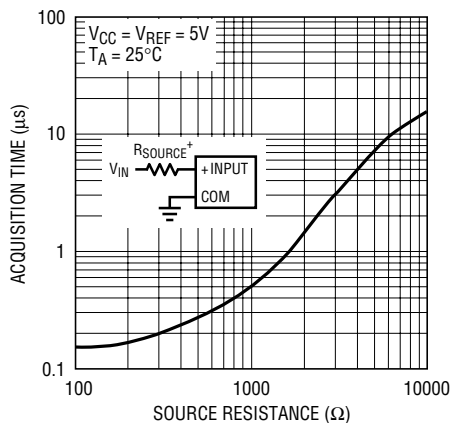

1197/99 G25

Maximum Clock Frequency vs Supply Voltage

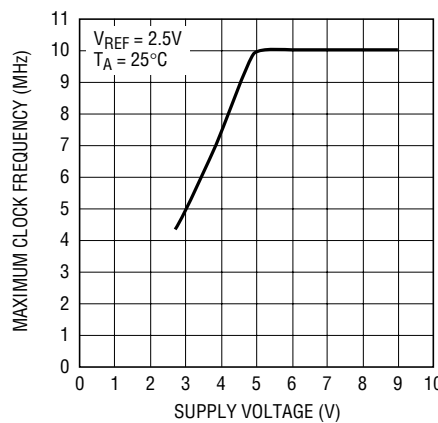

1197/99 G26

Maximum Clock Frequency† vs Source Resistance

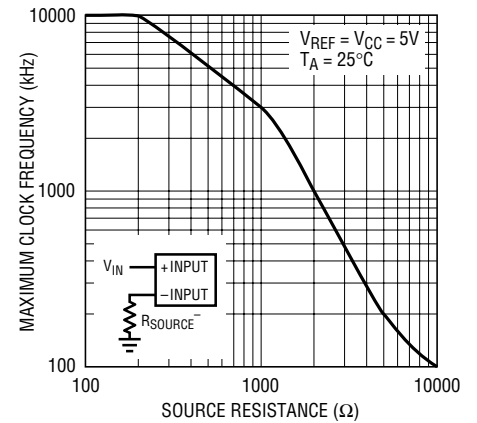

1197/99 G27

* As the CLK frequency is decreased from 2MHz, minimum CLK frequency ($\Delta error \leq 0.1LSB$) represents the frequency at which a 0.1LSB shift in any code translation from its 2MHz value is first detected.

† Maximum CLK frequency represents the clock frequency at which a 0.1LSB shift in the error at any code transition from its 3.5MHz value is first detected.

PIN FUNCTIONS

\overline{CS} (Pin 1): Chip Select Input. A logic low on this input enables the LTC1197/LTC1197L/LTC1199/LTC1199L. Power shutdown is activated when \overline{CS} is brought high.

+IN, CH0 (Pin 2): Analog Input. This input must be free of noise with respect to GND.

-IN, CH1 (Pin 3): Analog Input. This input must be free of noise with respect to GND.

GND (Pin 4): Analog Ground. GND should be tied directly to an analog ground plane.

V_{REF} (Pin 5): LTC1197/LTC1197L Reference Input. The reference input defines the span of the A/D converter and must be kept free of noise with respect to GND.

D_{IN} (Pin 5): LTC1199/LTC1199L Digital Data Input. The A/D configuration word is shifted into this input.

D_{OUT} (Pin 6): Digital Data Output. The A/D conversion result is shifted out of this output.

CLK (Pin 7): Shift Clock. This clock synchronizes the serial data transfer.

V_{CC} (Pin 8): Positive Supply. This supply must be kept free of noise and ripple by bypassing directly to the analog ground plane. For LTC1199/LTC1199L, V_{REF} is tied internally to this pin.

BLOCK DIAGRAM

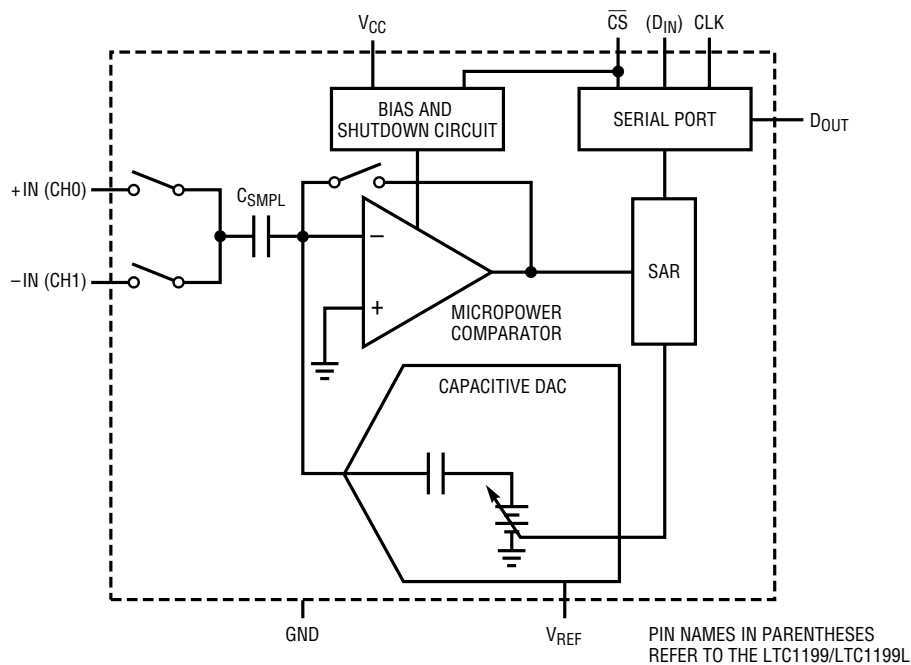

TEST CIRCUITS

Load Circuit for t_{dDO} , t_r , t_f , t_{dis} and t_{en}

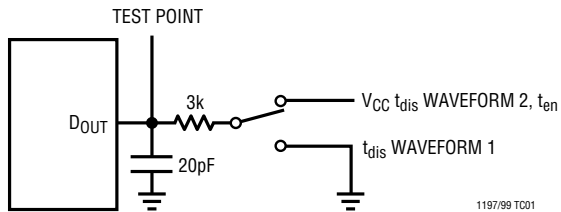

Voltage Waveforms for D_{OUT} Rise and Fall Times, t_r , t_f

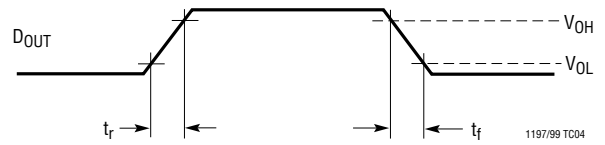

Voltage Waveforms for D_{OUT} Delay Time, t_{dDO}

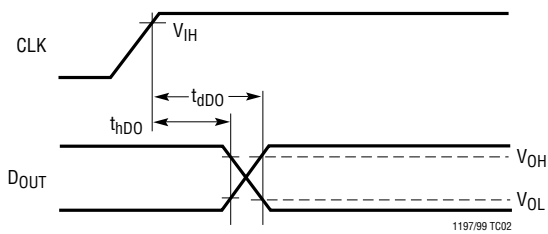

Voltage Waveforms for t_{dis}

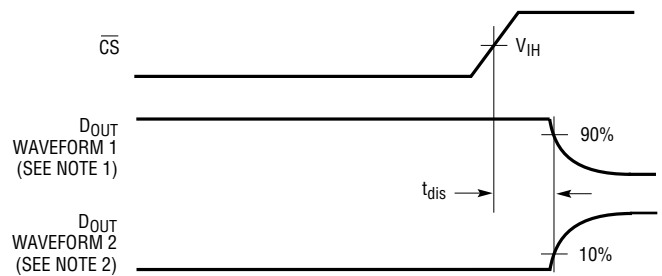

NOTE 1: WAVEFORM 1 IS FOR AN OUTPUT WITH INTERNAL CONDITIONS SUCH THAT THE OUTPUT IS HIGH UNLESS DISABLED BY THE OUTPUT CONTROL
NOTE 2: WAVEFORM 2 IS FOR AN OUTPUT WITH INTERNAL CONDITIONS SUCH THAT THE OUTPUT IS LOW UNLESS DISABLED BY THE OUTPUT CONTROL

1197/99 TC05

LTC1197/LTC1197L t_{en} Voltage Waveforms

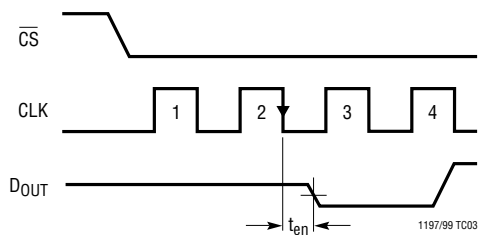

LTC1199/LTC1199L t_{en} Voltage Waveforms

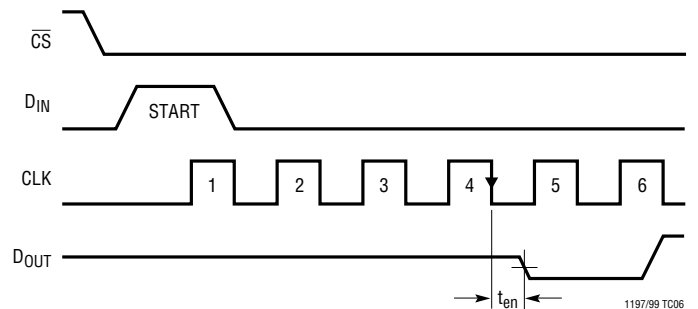

APPLICATIONS INFORMATION

OVERVIEW

The LTC1197/LTC1197L/LTC1199/LTC1199L are 10-bit switched-capacitor A/D converters. These sampling ADCs typically draw 5mA of supply current when sampling up to 500kHz (800µA at 2.7V sampling up to 250kHz). Supply current drops linearly as the sample rate is reduced (see Supply Current vs Sample Rate in the Typical Performance Characteristics). The ADCs automatically power down when not performing a conversion, drawing only leakage current. They are packaged in 8-pin MSOP and SO packages. The LTC1197L/LTC1199L operate on a single supply ranging from 2.7V to 4V. The LTC1197 operates on a single supply ranging from 4V to 9V while the LTC1199 operates from 4V to 6V.

These ADCs contain a 10-bit, switched-capacitor ADC, a sample-and-hold and a serial port (see Block Diagram). Although they share the same basic design, the LTC1197/LTC1197L and LTC1199/LTC1199L differ in some respects. The LTC1197/LTC1197L have a differential input and have an external reference input pin. They can measure signals floating on a DC common mode voltage and can operate with reduced spans down to 200mV. Reducing the span allows it to achieve 200µV resolution. The LTC1199/LTC1199L have a 2-channel input multiplexer with the reference connected to the supply (V_{CC}) pin. They can convert the input voltage of either channel with respect to ground or the difference between the voltages of the two channels.

SERIAL INTERFACE

The LTC1199/LTC1199L communicate with microprocessors and other external circuitry via a synchronous, half duplex, 4-wire serial interface while the LTC1197/LTC1197L use a 3-wire interface (see Operating Sequence in Figures 1 and 2). These interfaces are compatible with both SPI and MICROWIRE protocols without requiring any additional glue logic (see MICROPROCESSOR INTERFACES: Motorola SPI).

DATA TRANSFER

The CLK synchronizes the data transfer with each bit being transmitted and captured on the rising CLK edge in both transmitting and receiving systems. The LTC1199/LTC1199L first receives input data and then transmits back the A/D conversion result (half duplex). Because of the half-duplex operation, D_{IN} and D_{OUT} may be tied together allowing transmission over just three wires: \overline{CS} , CLK and DATA (D_{IN}/D_{OUT}).

Data transfer is initiated by a falling chip select (\overline{CS}) signal. After \overline{CS} falls the LTC1199/LTC1199L look for a start bit on the D_{IN} input. After the start bit is received, the 3-bit input word is shifted into the D_{IN} input which configures the LTC1199/LTC1199L and starts the conversion. After two null bits, the result of the conversion is output on the D_{OUT} line in MSB-first format. At the end of the data exchange \overline{CS} should be brought high. This resets the LTC1199/LTC1199L in preparation for the next data exchange. Bringing \overline{CS} high after the conversion also minimizes supply current if CLK is left running.

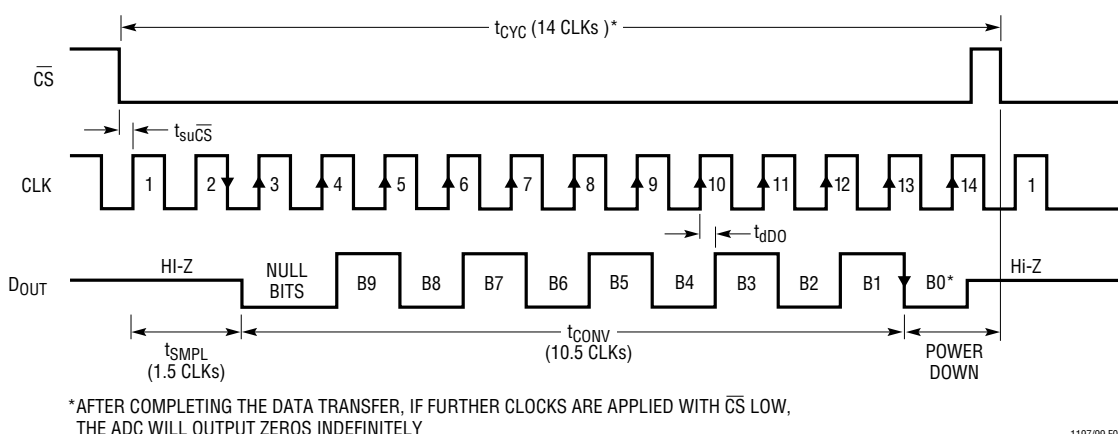

Figure 1. LTC1197/LTC1197L Operating Sequence

1197/99 F01

APPLICATIONS INFORMATION

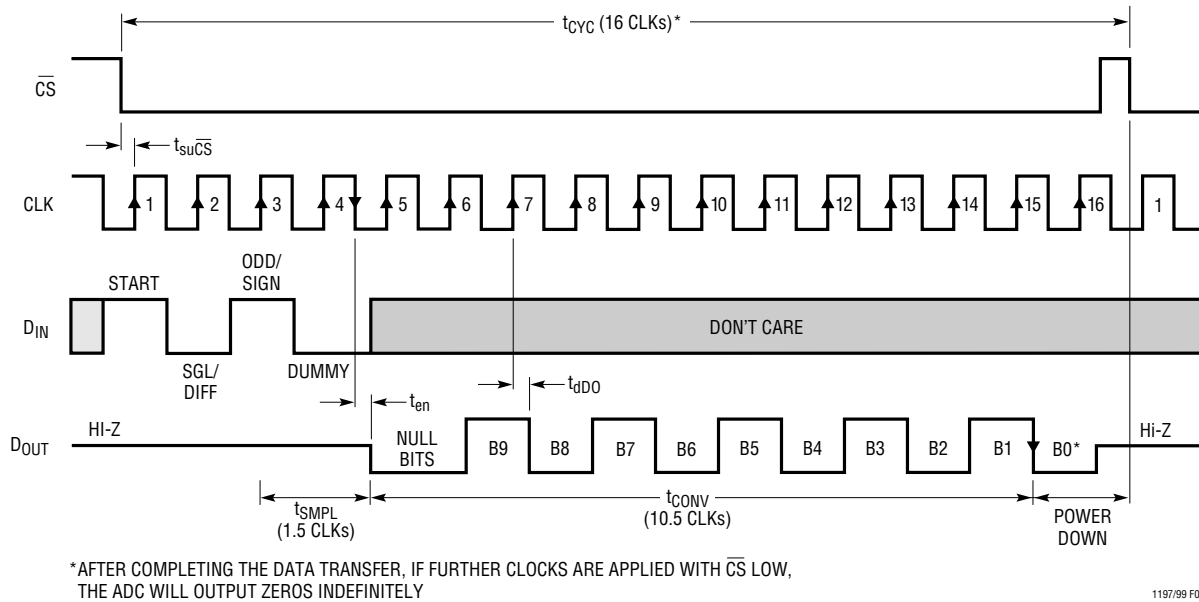
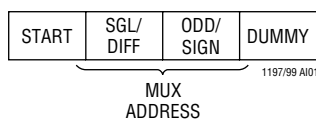

Figure 2. LTC1199/LTC1199L Operating Sequence

The LTC1197/LTC1197L do not require a configuration input word and have no D_{IN} pin. A falling \overline{CS} initiates data transfer as shown in the LTC1197/LTC1197L operating sequence. After \overline{CS} falls, the second CLK pulse enables D_{OUT} . After two null bits, the A/D conversion result is output on the D_{OUT} line in MSB-first format. Bringing \overline{CS} high resets the LTC1197/LTC1197L for the next data exchange and minimizes the supply current if CLK is continuously running.

INPUT DATA WORD (LTC1199/LTC1199L ONLY)

The LTC1199 4-bit data word is clocked into the D_{IN} input on the rising edge of the clock after \overline{CS} goes low and the start bit has been recognized. Further inputs on the D_{IN} pin are then ignored until the next \overline{CS} cycle. The input word is defined as follows:



Start Bit

The first “logical one” clocked into the D_{IN} input after \overline{CS} goes low is the start bit. The start bit initiates the data

transfer and all leading zeros that precede this logical one will be ignored. After the start bit is received the remaining bits of the input word will be clocked in. Further inputs on the D_{IN} pin are then ignored until the next \overline{CS} cycle.

Multiplexer (MUX) Address

The bits of the input word following the start bit assign the MUX configuration for the requested conversion. For a given channel selection, the converter will measure the voltage between the two channels indicated by the “+” and “-” signs in the selected row of the following table. In single-ended mode, all input channels are measured with respect to GND. Only the + inputs have sample-and-holds. Signals applied at the - inputs must not change more than the required accuracy during the conversion.

Multiplexer Channel Selection

MUX ADDRESS		CHANNEL #		
SGL/DIFF	ODD/SIGN	0	1	GND
1	0	+		-
1	1		+	-
0	0	+	-	
0	1	-	+	

1197/99 A102

APPLICATIONS INFORMATION

Dummy Bit

The dummy bit is a placeholder that extends the acquisition time of the ADC. This bit can be either high or low and does not affect the conversion of the ADC.

Operation with D_{IN} and D_{OUT} Tied Together

The LTC1199/LTC1199L can be operated with D_{IN} and D_{OUT} tied together. This eliminates one of the lines required to communicate to the microprocessor (MPU). Data is transmitted in both directions on a single wire. The processor pin connected to this data line should be configurable as either an input or an output. The processor pin connected to this data line should be configurable as either an input or an output. The LTC1199/LTC1199L will take control of the data line and drive it low on the 4th falling CLK edge after the start bit is received (see Figure 3). Therefore the processor port line must be switched to an input before this happens to avoid a conflict.

In the Typical Applications section, there is an example of interfacing the LTC1199/LTC1199L with D_{IN} and D_{OUT} tied together to the Intel 8051 MPU.

Unipolar Transfer Curve

The LTC1197/LTC1197L/LTC1199/LTC1199L are permanently configured for unipolar only. The input span and code assignment for this conversion type are shown in the following figures for a 5V reference.

Unipolar Transfer Curve

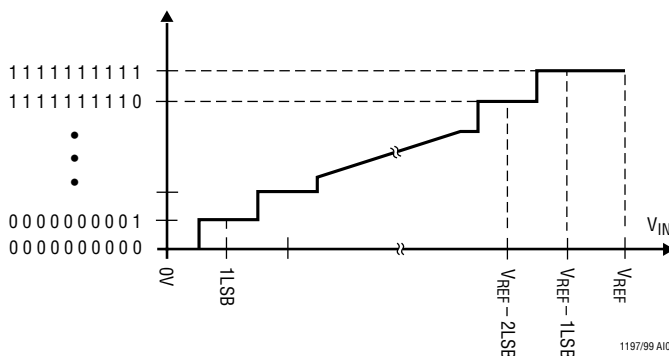

Unipolar Output Code

OUTPUT CODE	INPUT VOLTAGE	INPUT VOLTAGE ($V_{REF} = 5.000V$)
1111111111	$V_{REF} - 1LSB$	4.99512V
1111111110	$V_{REF} - 2LSB$	4.99023V
⋮	⋮	⋮
0000000001	1LSB	4.88mV
0000000000	0V	0V

1197/99 AI04

ACHIEVING MICROPOWER PERFORMANCE

With typical operating currents of 5mA (LTC1197/LTC1199) at 5V and 0.8mA (LTC1197L/LTC1199L) at 2.7V it is possible for these ADCs to achieve true micropower performance by taking advantage of the automatic shutdown between conversions. In systems

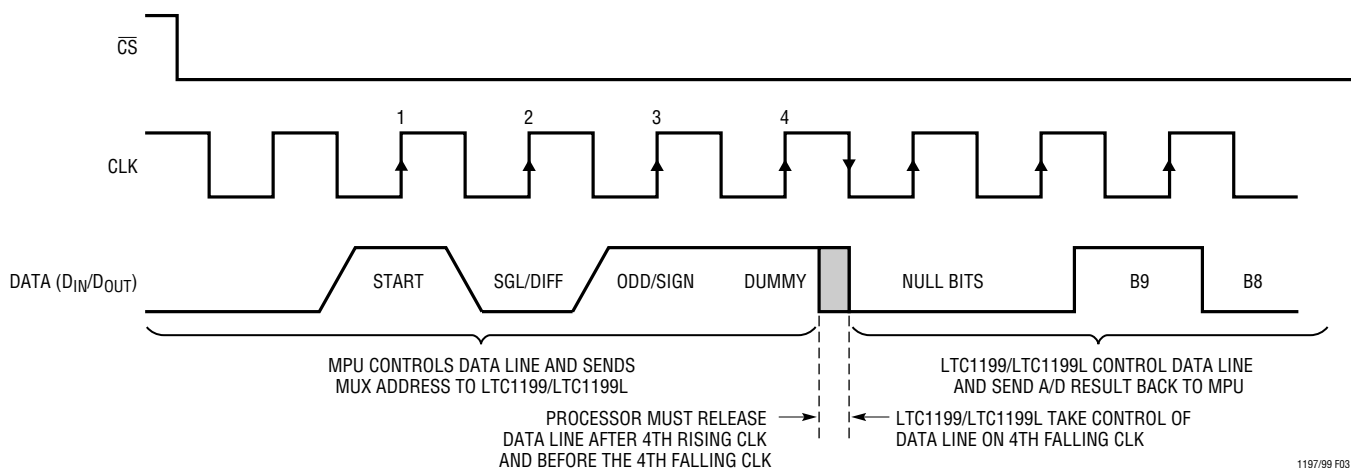

1197/99 F03

Figure 3. LTC1199/LTC1199L Operation with D_{IN} and D_{OUT} Tied Together

APPLICATIONS INFORMATION

that convert continuously, the LTC1197/LTC1197L/LTC1199/LTC1199L will draw their normal operating power continuously. Several things must be taken into account to achieve micropower operation.

Shutdown

Figures 1 and 2 show the operating sequence of the LTC1197/LTC1197L/LTC1199/LTC1199L. The converter draws power when the \overline{CS} pin is low and powers itself down when that pin is high. If the \overline{CS} pin is not taken all the way to ground when it is low and not taken to V_{CC} when it is high, the input buffers of the converter will draw current. This current may be tens of microamps. It is worthwhile to bring the \overline{CS} pin all the way to ground when it is low and all the way to V_{CC} when it is high to obtain the lowest supply current.

When the \overline{CS} pin is high (= supply voltage), the converter is in shutdown mode and draws only leakage current. The status of the D_{IN} and CLK inputs have no effect on supply current during this time. There is no need to stop D_{IN} and CLK with $\overline{CS} = \text{high}$, except the MPU may benefit.

Minimize \overline{CS} Low Time

In systems that have significant time between conversions, lowest power drain will occur with the minimum \overline{CS} low time. Bringing \overline{CS} low, transferring data as quickly as possible, and then returning \overline{CS} high will result in the lowest possible current drain. This minimizes the amount of time the device draws power. Even though the device draws more power at high clock rates, the net power is less because the device is on for a shorter time.

D_{OUT} Loading

Capacitive loading on the digital output can increase power consumption. A 100pF capacitor on the D_{OUT} pin can add 200 μA to the supply current at a 7.2MHz clock frequency. The extra 200 μA goes into charging and discharging the load capacitor. The same goes for digital lines driven at a high frequency by any logic. The $C \cdot V \cdot f$ currents must be evaluated and the troublesome ones minimized.

Lower Supply Voltage

For lower supply voltages, LTC offers the LTC1197L/LTC1199L. These pin compatible devices offer specified performance to 2.7V supplies.

OPERATING ON OTHER THAN 5V SUPPLIES

The LTC1197 operates from 4V to 9V supplies and the LTC1199 operates from 4V to 6V supplies. The LTC1197L/LTC1199L operate from 2.7V to 4V supplies. To use these parts at other than 5V supplies a few things must be kept in mind.

Bypassing

At higher supply voltages, bypass capacitors on V_{CC} and V_{REF} if applicable, need to be increased beyond what is necessary for 5V. For a 9V supply a 10 μF tantalum in parallel with a 0.1 μF ceramic is recommended.

Input Logic Levels

The input logic levels of \overline{CS} , CLK and D_{IN} are made to meet TTL threshold levels on a 5V supply. When the supply voltage varies, the input logic levels also change. For the ADC to sample and convert correctly, the digital inputs have to meet logic low and high levels relative to the operating supply voltage (see typical curve of Digital Input Logic Threshold vs Supply Voltage). If achieving micropower consumption is desirable, the digital inputs must go rail-to-rail between V_{CC} and ground (see ACHIEVING MICROPOWER PERFORMANCE section).

Clock Frequency

The maximum recommended clock frequency is 7.2MHz for the LTC1197/LTC1199 running off a 5V supply and 3.5MHz for the LTC1197L/LTC1199L running off a 2.7V supply. With the supply voltage changing, the maximum clock frequency for the devices also changes (see the typical curve of Maximum Clock Rate vs Supply Voltage). If the maximum clock frequency is used, care must be taken to ensure that the device converts correctly.

APPLICATIONS INFORMATION

Mixed Supplies

It is possible to have a microprocessor running off a 5V supply and communicate with the ADC operating on 3V or 9V supplies. The requirement to achieve this is that the outputs of \overline{CS} , CLK and D_{IN} from the MPU have to be able to trip the equivalent inputs of the ADC and the output of the ADC must be able to toggle the equivalent input of the MPU (see typical curve of Digital Input Logic Threshold vs Supply Voltage). With the LTC1197 operating on a 9V supply, the output of D_{OUT} may go between 0V and 9V. The 9V output may damage the MPU running off a 5V supply. The way to solve this problem is to have a resistor divider on D_{OUT} (Figure 4) and connect the center point to the MPU input. It should be noted that to get full shutdown, the \overline{CS} input of the ADC must be driven to the V_{CC} voltage. This would require adding a level shift circuit to the \overline{CS} signal in Figure 4.

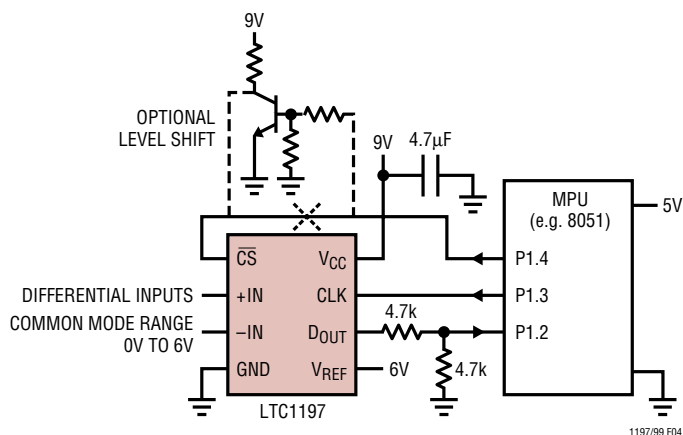

Figure 4. Interfacing a 9V-Powered LTC1197 to a 5V System

BOARD LAYOUT CONSIDERATIONS

Grounding and Bypassing

The LTC1197/LTC1197L/LTC1199/LTC1199L should be used with an analog ground plane and single point grounding techniques. The GND pin should be tied directly to the ground plane. The V_{CC} pin should be bypassed to the ground plane using a 1 μ F tantalum capacitor with leads as short as possible. All analog inputs should be referenced directly to the single point ground. Digital inputs and outputs should be shielded from and/or routed away from the reference and analog circuitry.

SAMPLE-AND-HOLD

The LTC1197/LTC1197L/LTC1199/LTC1199L provide a built-in sample-and-hold (S/H) function to acquire signals. The S/H of the LTC1197/LTC1197L acquires input signals for the “+” input relative to the “-” input during the t_{SMPL} time (see Figure 1). However the S/H of the LTC1199/LTC1199L can sample input signals from the “+” input relative to ground and from the “-” input relative to ground in addition to acquiring signals from the “+” input relative to the “-” input (see Figure 5) during t_{SMPL} .

Single-Ended Inputs

The sample-and-hold of the LTC1199/LTC1199L allows conversion of rapidly varying signals. The input voltage is sampled during the t_{SMPL} time as shown in Figure 5. The sampling interval begins as the ODD/SGN bit is shifted in and continues until the falling CLK edge after the dummy bit is received. On this falling edge, the S/H goes into hold mode and the conversion begins.

Differential Inputs

With differential inputs, the ADC no longer converts just a single voltage but rather the difference between two voltages. In this case, the voltage on the selected “+” input is still sampled and held and therefore may be rapidly time varying just as in single-ended mode. However, the voltage on the selected “-” input must remain constant and be free of noise and ripple throughout the conversion time. Otherwise, the differencing operation may not be performed accurately. The conversion time is 10.5 CLK cycles. Therefore, a change in the “-” input voltage during this interval can cause conversion errors. For a sinusoidal voltage on the “-” input this error would be:

$$V_{ERROR (MAX)} = V_{PEAK} \cdot 2 \cdot \pi \cdot f(“-”) \cdot 10.5/f_{CLK}$$

Where $f(“-”)$ is the frequency of the “-” input voltage, V_{PEAK} is its peak amplitude and f_{CLK} is the frequency of the CLK. In most cases V_{ERROR} will not be significant. For a 60Hz signal on the “-” input to generate a 1/4LSB error (1.22mV) with the converter running at CLK = 7.2MHz, its peak value would have to be 2.22V.

APPLICATIONS INFORMATION

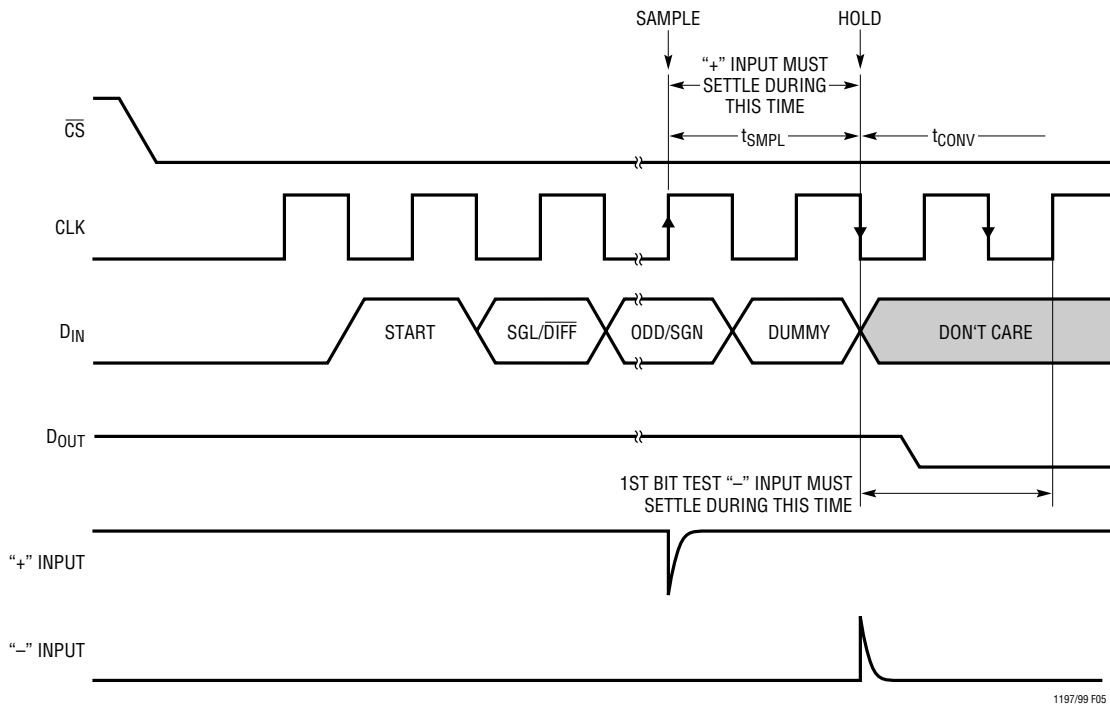

Figure 5. LTC1199/LTC1199L “+” and “-” Input Settling Windows

ANALOG INPUTS

Because of the capacitive redistribution A/D conversion techniques used, the analog inputs of the LTC1197/LTC1197L/LTC1199/LTC1199L have capacitive switching input current spikes. These current spikes settle quickly and do not cause a problem if source resistances are less than 200Ω or high speed op amps are used (e.g., the LT[®]1224, LT1191, LT1226 or LT1215). However, if large source resistances are used or if slow settling op amps drive the inputs, take care to ensure that the transients caused by the current spikes settle completely before the conversion begins.

“+” Input Settling

The input capacitor of the LTC1197/LTC1197L is switched onto the “+” input in the falling edge of CS and the sample time continues until the second falling CLK edge (see Figure 1). However, the input capacitor of the LTC1199/LTC1199L is switched onto “+” input after ODD/SGN is clocked into the ADC and remains there until the fourth falling CLK edge (see Figure 5). The sample time is 1.5 CLK cycles before conversion starts. The voltage on the “+”

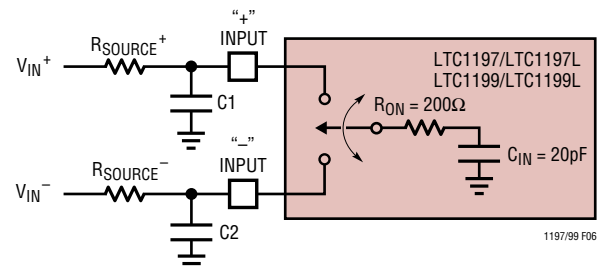

Figure 6. Analog Equivalent Circuit

input must settle completely within t_{SMPL} for the ADC to perform an accurate conversion. Minimizing $R_{SOURCE+}$ and $C1$ will improve the input settling time (see Figure 6). If a large “+” input source resistance must be used, the sample time can be increased by using a slower CLK frequency.

“-” Input Settling

At the end of t_{SMPL} , the input capacitor switches to the “-” input and conversion starts (see Figures 1 and 5). During the conversion the “+” input voltage is effectively “held” by the sample-and-hold and will not affect the

APPLICATIONS INFORMATION

conversion result. However, it is critical that the “-” input voltage settles completely during the first CLK cycle of the conversion time and be free of noise. Minimizing R_{SOURCE^-} and C_2 will improve settling time (see Figure 6). If a large “-” input source resistance must be used, the time allowed for settling can be extended by using a slower CLK frequency.

Input Op Amps

When driving the analog inputs with an op amp it is important that the op amp settle within the allowed time (see Figure 5). Again, the “+” and “-” input sampling times can be extended as described above to accommodate slower op amps. High speed op amps such as the LT1224, LT1191, LT1226 or LT1215 can be made to settle well even with the minimum settling window of 200ns which occurs at the maximum clock rate of 7.2MHz.

Source Resistance

The analog inputs of the LTC1197/LTC1197L/LTC1199/LTC1199L look like a 20pF capacitor (C_{IN}) in series with a 200Ω resistor (R_{ON}) as shown in Figure 6. C_{IN} gets switched between the selected “+” and “-” inputs once during each conversion cycle. Large external source resistors and capacitors will slow the settling of the inputs. It is important that the overall RC time constants be short enough to allow the analog inputs to completely settle within the allowed time.

RC Input Filtering

It is possible to filter the inputs with an RC network as shown in Figure 7. For large values of C_F (e.g., 1μF), the capacitive input switching currents are averaged into a net DC current. Therefore, a filter should be chosen with a small resistor and large capacitor to prevent DC drops

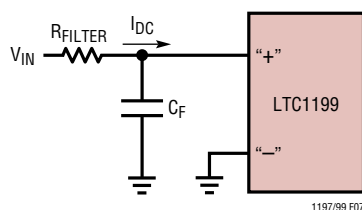

Figure 7. RC Input Filtering

across the resistor. The magnitude of the DC current is approximately $I_{DC} = 20pF(V_{IN}/t_{CYC})$ and is roughly proportional to V_{IN} . When running at the minimum cycle time of 2μs, the input current equals 50μA at $V_{IN} = 5V$. In this case a filter resistor of 10Ω will cause 0.1LSB of full-scale error. If a larger filter resistor must be used, errors can be eliminated by increasing the cycle time.

Input Leakage Current

Input leakage currents can also create errors if the source resistance gets too large. For instance, the maximum input leakage specification of 1μA (at 85°C) flowing through a source resistance of 1k will cause a voltage drop of 1mV or 0.2LSB. This error will be much reduced at lower temperatures because leakage drops rapidly (see typical curve of Input Channel Leakage Current vs Temperature).

REFERENCE INPUTS

The voltage on the reference input of the LTC1197/LTC1197L defines the voltage span of the A/D converter. The reference input transient capacitive switching currents are due to the switched-capacitor conversion technique used in these ADCs (see Figure 8). During each bit test of the conversion (every CLK cycle), a capacitive current spike will be generated on the reference pin by the ADC. These current spikes settle quickly and do not cause a problem.

Reduced Reference Operation

The minimum reference voltage of the LTC1199 is 4V and the minimum reference voltage of the LTC1199L is 2.7V because the V_{CC} supply and reference are internally tied together. However, the LTC1197/LTC1197L can operate with reference voltages below 1V.

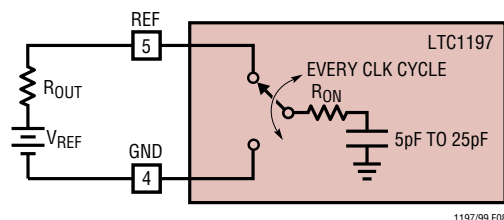

Figure 8. Reference Input Equivalent Circuit

APPLICATIONS INFORMATION

The effective resolution of the LTC1197/LTC1197L can be increased by reducing the input span of the converter. The LTC1197/LTC1197L exhibits good linearity and gain over a wide range of reference voltages (see typical curves of Linearity and Full-Scale Error vs Reference Voltage). However, care must be taken when operating at low values of V_{REF} because of the reduced LSB step size and the resulting higher accuracy requirement placed on the converter. The following factors must be considered when operating at low V_{REF} values.

1. Offset
2. Noise
3. Conversion speed (CLK frequency)

Offset with Reduced V_{REF}

The offset of the LTC1197/LTC1197L has a larger effect on the output code when the ADC is operated with reduced reference voltage. The offset (which is typically a fixed voltage) becomes a larger fraction of an LSB as the size of the LSB is reduced. The typical curve of LTC1197 Offset Error vs Reference Voltage shows how offset in LSBs is related to reference voltage for a typical value of V_{OS} . For example, a V_{OS} of 1mV which is 0.2LSB with a 5V reference becomes 1LSB with a 1V reference and 5LSBs with a 0.2V reference. If this offset is unacceptable, it can be corrected digitally by the receiving system or by offsetting the “–” input of the LTC1197/LTC1197L.

Noise with Reduced V_{REF}

The total input referred noise of the LTC1197/LTC1197L can be reduced to approximately 200 μ V peak-to-peak using a ground plane, good bypassing, good layout techniques and minimizing noise on the reference inputs. This noise is insignificant with a 5V reference but will become a larger fraction of an LSB as the size of the LSB is reduced.

For operation with a 5V reference, the 200 μ V noise is only 0.04LSB peak-to-peak. In this case, the LTC1197/

LTC1197L noise will contribute virtually no uncertainty to the output code. However, for reduced references, the noise may become a significant fraction of an LSB and cause undesirable jitter in the output code. For example, with a 1V reference, this same 200 μ V noise is 0.2LSB peak-to-peak. This will reduce the range of input voltages over which a stable output code can be achieved. If the reference is further reduced to 200mV, the 200 μ V of noise becomes equal to 1LSB and a stable code may be difficult to achieve. In this case, averaging readings may be necessary.

This noise data was taken in a very clean setup. Any setup-induced noise (noise or ripple on V_{CC} , V_{REF} or V_{IN}) will add to the internal noise. The lower the reference voltage to be used, the more critical it becomes to have a clean, noise-free setup.

Conversion Speed with Reduced V_{REF}

With reduced reference voltages the LSB step size is reduced and the LTC1197/LTC1197L internal comparator overdrive is reduced. Therefore, it may be necessary to reduce the maximum CLK frequency when low values of V_{REF} are used.

Input Divider

It is OK to use an input divider on the reference input of the LTC1197/LTC1197L as long as the reference input can be made to settle within the bit time at which the clock is running. When using a larger value resistor divider on the reference input, the “–” input should be matched with an equivalent resistance.

Bypassing Reference Input with Divider

Bypassing the reference input with a divider is also possible. However, care must be taken to make sure that the DC voltage on the reference input will not drop too much below the intended reference voltage.

APPLICATIONS INFORMATION

Signal-to-Noise Ratio

The signal-to-noise ratio (SNR) is the ratio between the RMS amplitude of the fundamental input frequency to the RMS amplitude of all other frequency components at the A/D output. This includes distortion as well as noise products and for this reason it is sometimes referred to as signal-to-noise + distortion $[S/(N + D)]$. The output is band limited to frequencies from DC to one half the sampling frequency. Figure 9 shows spectral content from DC to 250kHz which is 1/2 the 500kHz sampling rate.

Effective Number of Bits

The effective number of bits (ENOBs) is a measurement of the resolution of an ADC and is directly related to the $S/(N + D)$ by the equation:

$$ENOB = [S/(N + D) - 1.76]/6.02$$

where $S/(N + D)$ is expressed in dB. At the maximum sampling rate of 500kHz, the LTC1197 maintains 9.5 ENOBs or better to 200kHz. Above 200kHz, the ENOBs gradually decline, as shown in Figure 10, due to increasing second harmonic distortion. The noise floor remains approximately 100dB.

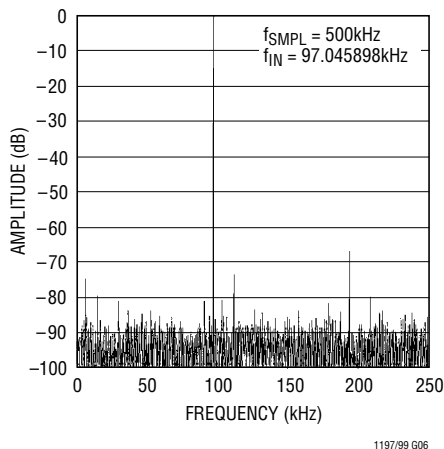

Figure 9. This Clean FFT of a 97kHz Input Shows Remarkable Performance for an ADC Sampling at the 500kHz Rate

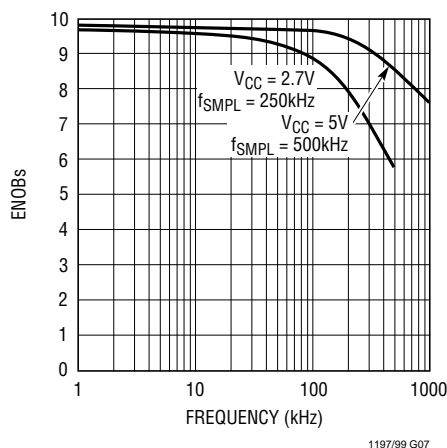

Figure 10. Dynamic Accuracy is Maintained Up to an Input Frequency of 200kHz for the LTC1197 and 50kHz for the LTC1197L

TYPICAL APPLICATIONS

MICROPROCESSOR INTERFACES

The LTC1197/LTC1197L/LTC1199/LTC1199L can interface directly (without external hardware to most popular microprocessor (MPU) synchronous serial formats (see Table 1). If an MPU without a dedicated serial port is used, then three or four of the MPU's parallel port lines can be programmed to form the serial link. Included here is one serial interface example and one example showing a parallel port programmed to form the serial interface.

Motorola SPI (MC68HC05C4, MC68HC11)

The MC68HC05C4 has been chosen as an example of an MPU with a dedicated serial port. This MPU transfers data MSB-first and in 8-bit increments. With two 8-bit transfers, the A/D result is read into the MPU. The first 8-bit transfer sends the D_{IN} word to the LTC1199 and clocks the two ADC MSBs (B9 and B8) into the MPU. The second 8-bit transfer clocks the next 8 bits, B7 through B0, of the ADC into the MPU.

ANDing the first MPU received byte with 03Hex clears the six MSBs. Notice how the position of the start bit in the D_{IN} word is used to position the A/D result so that it is right-justified in two memory locations.

Table 1. Microprocessor with Hardware Serial Interfaces Compatible with the LTC1197/LTC1197L/LTC1199/LTC1199L

PART NUMBER	TYPE OF INTERFACE
Motorola	
MC6805S2,S3	SPI
MC68HC11	SPI
MC68HC05	SPI
RCA	
CDP68HC05	SPI
Hitachi	
HD6301	SCI Synchronous
HD6303	SCI Synchronous
HD6305	SCI Synchronous
HD63701	SCI Synchronous
HD63705	SCI Synchronous
HD64180	CSI/O
National Semiconductor	
COP400 Family	MICROWIRE™
COP800 Family	MICROWIRE/PLUS™
NSC8050U	MICROWIRE/PLUS
HPC16000 Family	MICROWIRE/PLUS
Texas Instruments	
TMS7000 Family	Serial Port
TMS320 Family	Serial Port
Microchip Technology	
PIC16C60 Family	SPI, SCI Synchronous
PIC16C70 Family	SPI, SCI Synchronous

MICROWIRE and MICROWIRE/PLUS are trademarks of National Semiconductor Corp.

TYPICAL APPLICATIONS

Data Exchange Between LTC1199 and MC68HC05C4

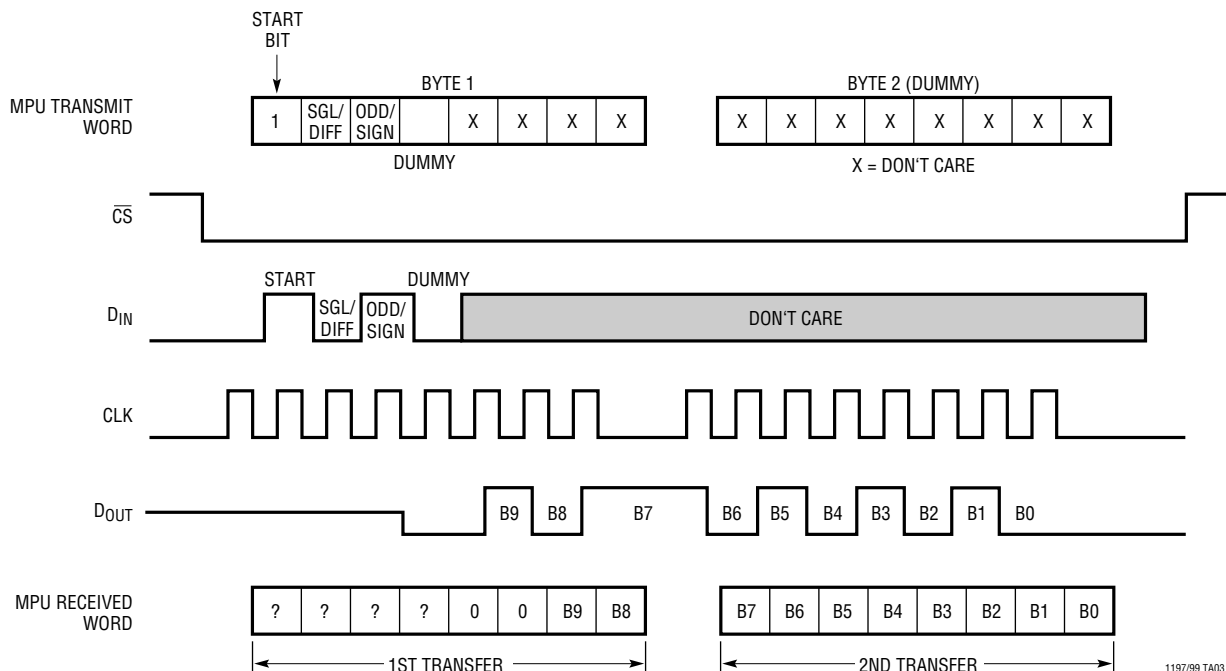

Hardware and Software Interface to Motorola MC68HC05C4

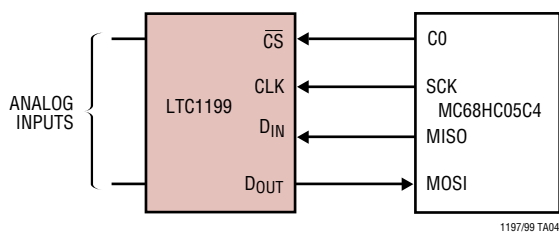

DOUT from LTC1199 Stored in MC68HC05C4

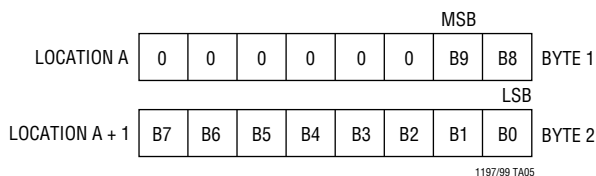

LABEL	MNEMONIC	COMMENTS
START	BCLRn	Bit 0 Port C goes low (\overline{CS} goes low)
	LDA	Load LTC1199 D_{IN} word into ACC
	STA	Load LTC1199 D_{IN} word into SPI from ACC
		Transfer begins
	TST	Test status of SPIF
	BPL	Loop to previous instruction if not done with transfer
	LDA	Load contents of SPI data register into ACC (D_{OUT} MSBs)
	STA	Start next SPI cycle
	AND	Clear 6 MSBs of the first D_{OUT} word
	STA	Store in memory location A (MSBs)
	TST	Test status of SPIF
	BPL	Loop to previous instruction if not done with transfer
	BSETn	Set B0 of Port C (\overline{CS} goes high)
	LDA	Load contents of SPI data register into ACC. (D_{OUT} LSBs)
	STA	Store in memory location A + 1 (LSBs)

TYPICAL APPLICATIONS

Interfacing to the Parallel Port of the Intel 8051 Family

The Intel 8051 has been chosen to demonstrate the interface between the LTC1199 and parallel port microprocessors. Normally, the \overline{CS} , CLK and D_{IN} signals would be generated on three port lines and the D_{OUT} signal read on a fourth port line. This works very well. However, we will demonstrate here an interface with the D_{IN} and D_{OUT} of the LTC1199 tied together as described in the SERIAL INTERFACE section. This saves one wire.

The 8051 first sends the start bit and MUX address to the LTC1199 over the data line connected to P1.2. Then P1.2 is reconfigured as an input (by writing to it a one) and the 8051 reads back the 8-bit A/D result over the same data line.

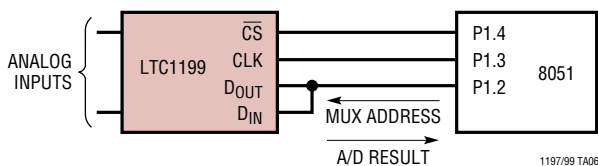

LABEL	MNEMONIC	OPERAND	COMMENTS
LOOP 1	MOV	A, #FFH	D_{IN} word for LTC1199
	SETB	P1.4	Make sure CS is high
	CLR	P1.4	\overline{CS} goes low
	MOV	R4, #04	Load counter
	RLC	A	Rotate D_{IN} bit into Carry
	CLR	P1.3	CLK goes low
	MOV	P1.2, C	Output D_{IN} bit into Carry
	SETB	P1.3	CLK goes high
	DJNZ	R4, LOOP 1	Next bit
	MOV	P1, #04	Bit 2 becomes an input
LOOP	CLR	P1.3	CLK goes low
	MOV	R4, #0AH	Load counter
	MOV	C, P1.2	Read data bit into Carry
	RLC	A	Rotate data bit into ACC
	SETB	P1.3	CLK goes high
	CLR	P1.3	CLK goes low
	DJNZ	R4, LOOP	Next bit
	MOV	R2, A	Store MSBs in R2
	MOV	C, P1.2	Read data bit into Carry
	SETB	P1.3	CLK goes high
	CLR	P1.3	CLK goes low
	CLR	A	Clear ACC
	RLC	A	Rotate data bit from Carry to ACC
	MOV	C, P1.2	Read data bit into Carry
	RRC	A	Rotate right into ACC
	RRC	A	Rotate right into ACC
	MOV	R3, A	Store LSBs in R3
	SETB	P1.4	\overline{CS} goes high

D_{OUT} from LTC1199 Stored in 8051 RAM

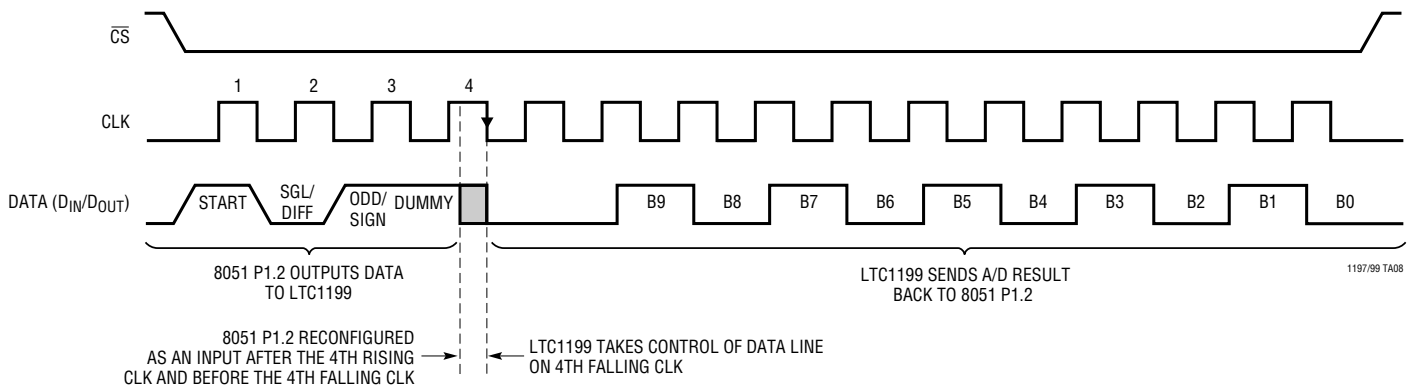
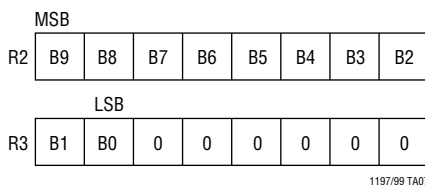

TYPICAL APPLICATIONS

A “Quick Look” Circuit for the LTC1197

Users can get a quick look at the function and timing of the LTC1197 by using the following simple circuit (Figure 11). V_{REF} is tied to V_{CC} . V_{IN} is applied to the +IN input and the -IN input is tied to the ground. \overline{CS} is driven at 1/16 the clock rate by the 74HC161 and D_{OUT} outputs the data. The output data from the D_{OUT} pin can be viewed on an

oscilloscope that is set up to trigger on the falling edge of \overline{CS} (Figure 12). Note that after the LSB is clocked out, the LTC1197 clocks out zeros until \overline{CS} goes high. Also note that with the resistor divider on D_{OUT} the output goes midway between V_{CC} and ground when in the high impedance mode.

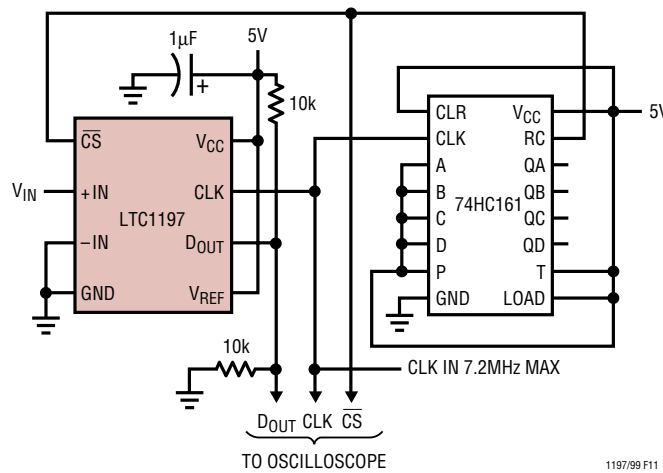

Figure 11. “Quick Look” Circuit for the LTC1197

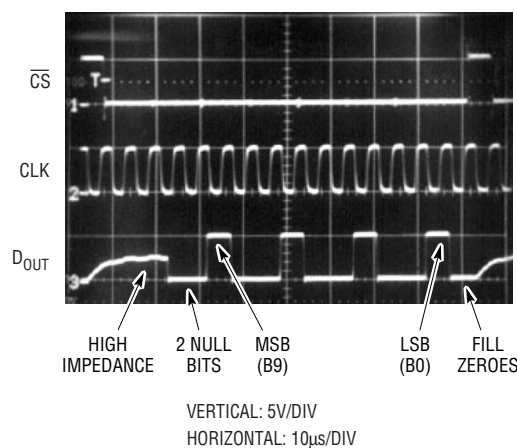

Figure 12. Scope Photo of the LTC1197 “Quick Look” Circuit Waveforms Showing A/D Output 1001001001 (249_{HEX})

TYPICAL APPLICATIONS

Resistive Touchscreen Interface

Figure 13 shows the LTC1199 in a 4-wire resistive touchscreen application. Transistor pairs Q1-Q3, Q2-Q4 apply 5V and ground to the X axis and Y axis, respectively. The LTC1199, with its 2-channel multiplexer, digitizes the voltage generated by each axis and transmits the conversion results to the system's processor through a serial

interface. RC combinations R1C1, R2C2 and R3C3 form lowpass filters that attenuate noise from possible sources such as the processor clock, switching power supplies and bus signals. The 74HC14 inverter is used to detect screen contact both during a conversion sequence and to trigger its start. Using the single channel LTC1197, 5-wire resistive touchscreens are as easily accommodated.

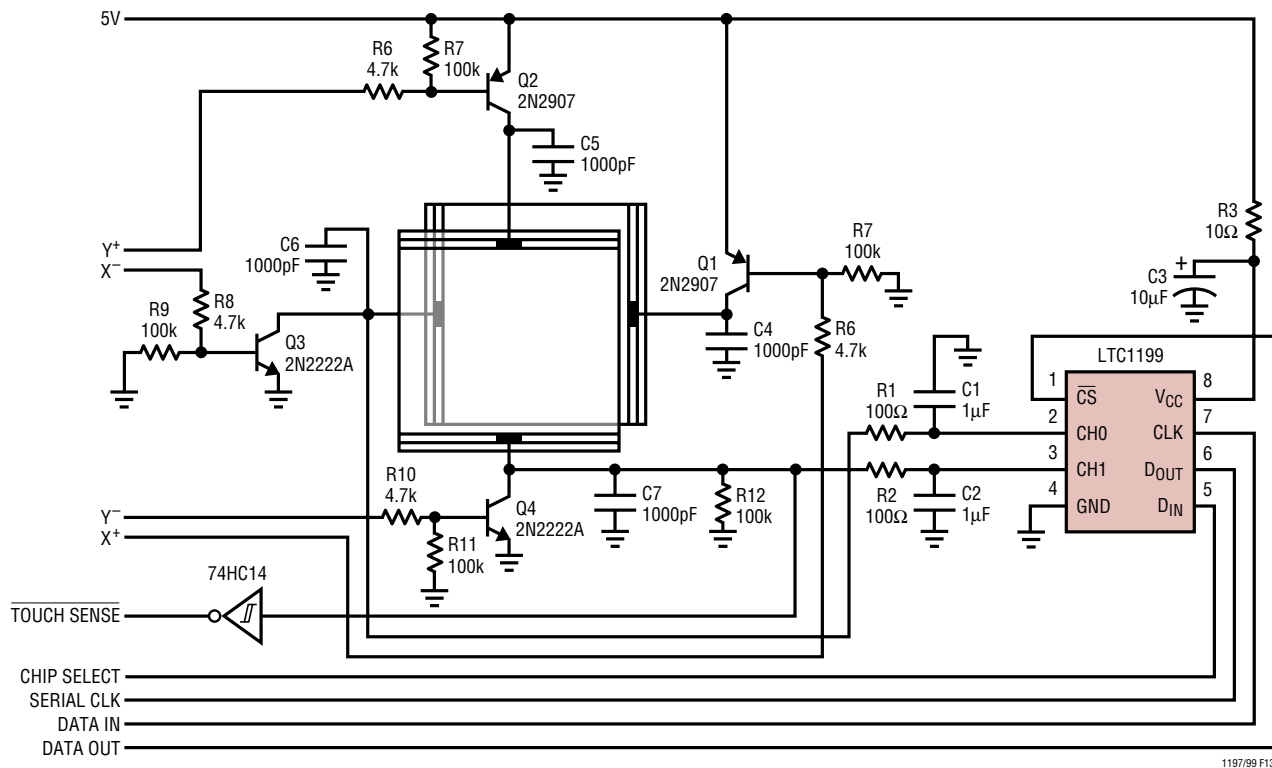

Figure 13. The LTC1199 Digitizes Resistive Touchscreen X and Y Axis Voltages. The ADC's Auto Shutdown Feature Helps Maximize Battery Life in Portable Touchscreen Equipment

TYPICAL APPLICATIONS

Battery Current Monitor

The LTC1197L/LTC1199L are ideal for 3V systems. Figure 14 shows a 2.7V to 4V battery current monitor that draws only 45µA at 3V from the battery it monitors, sampling at a 1Hz rate. To minimize supply current, the microprocessor uses the LTC1152 SHDN pin to turn on the op amp prior to making a measurement and then turn it off after the measurement has been made. The battery current is sensed with the 0.005Ω resistor and amplified

by the LTC1152. The LTC1197L digitizes the amplifier output and sends it to the microprocessor in serial format. After each sample the LTC1197L automatically powers down. The LT1004 provides the full-scale reference for the ADC. The circuit's 45µA supply current is dominated by the reference and the op amp. The circuit can be located near the battery and data transmitted serially to the microprocessor.

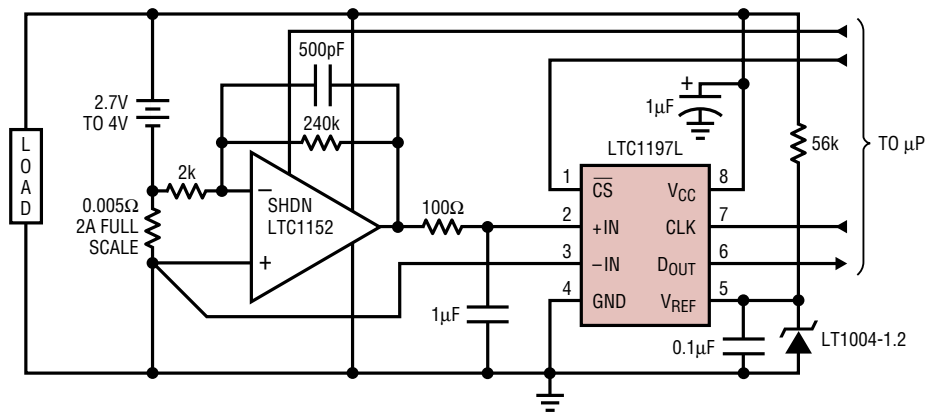
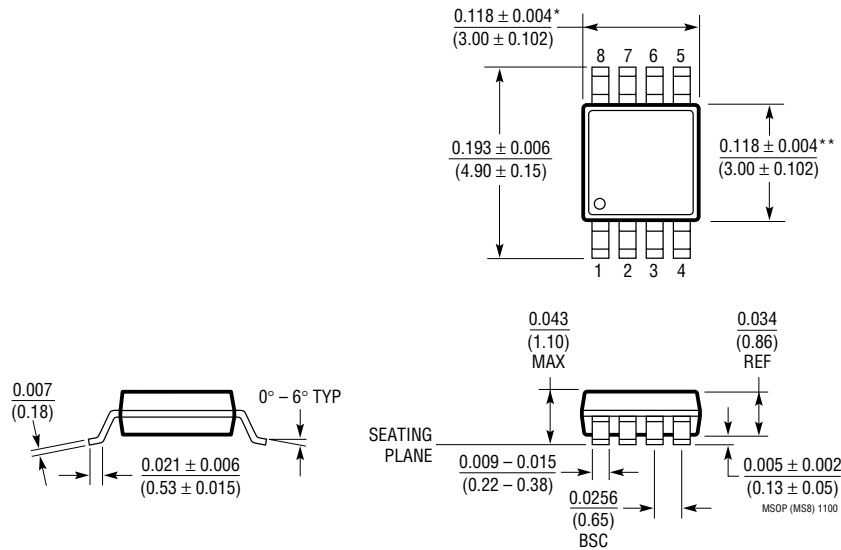

Figure 14. This 0A to 2A Battery Current Monitor Draws Only 45µA from a 3V Battery

PACKAGE DESCRIPTION

Dimensions in inches (millimeters), unless otherwise noted.

MS8 Package 8-Lead Plastic MSOP (LTC DWG # 05-08-1660)



* DIMENSION DOES NOT INCLUDE MOLD FLASH, PROTRUSIONS OR GATE BURRS. MOLD FLASH, PROTRUSIONS OR GATE BURRS SHALL NOT EXCEED 0.006" (0.152mm) PER SIDE

** DIMENSION DOES NOT INCLUDE INTERLEAD FLASH OR PROTRUSIONS. INTERLEAD FLASH OR PROTRUSIONS SHALL NOT EXCEED 0.006" (0.152mm) PER SIDE

S8 Package 8-Lead Plastic Small Outline (Narrow 0.150) (LTC DWG # 05-08-1610)

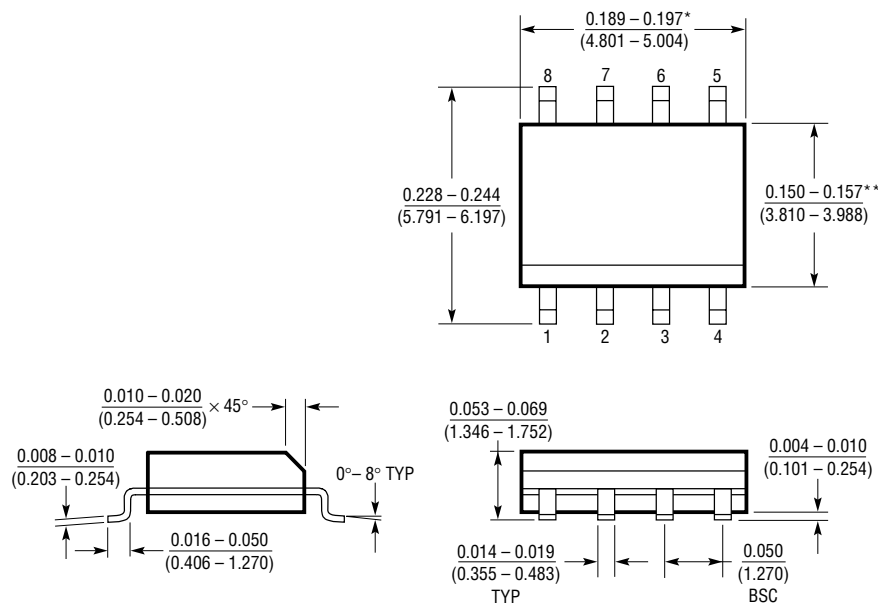

* DIMENSION DOES NOT INCLUDE MOLD FLASH. MOLD FLASH SHALL NOT EXCEED 0.006" (0.152mm) PER SIDE

** DIMENSION DOES NOT INCLUDE INTERLEAD FLASH. INTERLEAD FLASH SHALL NOT EXCEED 0.010" (0.254mm) PER SIDE

S08 1298

RELATED PARTS

PART NUMBER	SAMPLE RATE	POWER DISSIPATION	DESCRIPTION
8-Bit, Pin Compatible Serial Output ADCs			
LTC1096/LTC1096L	33kHz/15kHz	0.5mW*	1-Channel, Unipolar Operation with Reference Input, 5V/3V
LTC1098/LTC1098L	33kHz/15kHz	0.6mW*	2-Channel, Unipolar Operation, 5V/3V
LTC1196	1MHz/383kHz	20mW	1-Channel, Unipolar Operation with Reference Input, 5V/3V
LTC1198	750kHz/287kHz	20mW*	2-Channel, Unipolar Operation, 5V/3V
10-Bit Serial I/O ADCs			
LTC1090	25kHz	5mW	8-Channel, Bipolar or Unipolar Operation, 5V
LTC1091	30kHz	7.5mW	2-Channel, Unipolar Operation, 5V
LTC1092	35kHz	5mW	2-Channel, Unipolar Operation with Reference Input, 5V
LTC1093	25kHz	5mW	6-Channel, Bipolar or Unipolar Operation, 5V
LTC1094	25kHz	5mW	8-Channel, Bipolar or Unipolar Operation, 5V
LTC1283	15kHz	0.5mW	8-Channel, Bipolar or Unipolar Operation, 3V
12-Bit Serial I/O ADCs			
LTC1285/LTC1288	7.5kHz/6.6kHz	0.4mW/0.6mW*	1-Channel with Reference (LTC1285), 2-Channel (LTC1288), 3V
LTC1286/LTC1298	12.5kHz/11.1kHz	1.3mW/1.7mW*	1-Channel with Reference (LTC1286), 2-Channel (LTC1298), 5V
LTC1287	30kHz	3mW	1-Channel, Unipolar Operation, 3V
LTC1289	33kHz	3mW	8-Channel, Bipolar or Unipolar Operation, 3V
LTC1290	50kHz	30mW	8-Channel, Bipolar or Unipolar Operation, 5V
LTC1291	54kHz	30mW	2-Channel, Unipolar Operation, 5V
LTC1292	60kHz	30mW	1-Channel, Unipolar Operation, 5V
LTC1293	46kHz	30mW	6-Channel, Bipolar or Unipolar Operation, 5V
LTC1294	46kHz	30mW	8-Channel, Bipolar or Unipolar Operation, 5V
LTC1296	46kHz	30mW	8-Channel, Bipolar or Unipolar Operation, 5V
LTC1297	50kHz	30mW	1-Channel, Unipolar Operation, 5V
LTC1400	400kHz	75mW**	1-Channel, Bipolar or Unipolar Operation, Internal Reference, 5V
LTC1594/LTC1594L	20kHz/12.5kHz	1.6mW/0.5mW*	4-Channel, Unipolar Operation, 5V/3V
LTC1598/LTC1598L	20kHz/12.5kHz	1.6mW/0.5mW*	8-Channel, Unipolar Operation, 5V/3V
PART NUMBER	DESCRIPTION	COMMENTS	
Low Power References			
LT1004	Micropower Voltage Reference	0.3% Max, 20ppm/°C Typ, 10µA Max	
LT1019	Precision Bandgap Reference	0.05% Max, 5ppm/°C Max	
LT1236	Precision Low Noise Reference	0.05% Max, 5ppm/°C Max, SO Package	
LT1460-2.5	Micropower Precision Series Reference	0.075% Max, 10ppm/°C Max, 130µA Max, SO Package	
LT1634	Micropower Precision Reference	0.05% Max, 25ppm/°C Max, 7µA Max, MSOP Package	

*These devices have auto shutdown which reduces power dissipation linearly as sample rate is reduced from $f_{SAMPL(MAX)}$.

**Has nap and sleep shutdown modes.