

ANY-RATE PRECISION CLOCK MULTIPLIER/JITTER ATTENUATOR

Description

The Si5368 is a jitter-attenuating precision clock multiplier for applications requiring sub 1 ps rms jitter performance. The Si5368 accepts four clock inputs ranging from 2 kHz to 710 MHz and generates five independent, synchronous clock outputs ranging from 2 kHz to 945 MHz and select frequencies to 1.4 GHz. The device provides virtually any frequency translation combination across this operating range. The outputs are divided down separately from a common source. The Si5368 input clock frequency and clock multiplication ratio are programmable through an I²C or SPI interface. The Si5368 is based on Silicon Laboratories' 3rd-generation DSPLL[®] technology, which provides any-rate frequency synthesis and jitter attenuation in a highly integrated PLL solution that eliminates the need for external VCXO and loop filter components. The DSPLL loop bandwidth is digitally programmable, providing jitter performance optimization at the application level. Operating from a single 1.8 or 2.5 V supply, the Si5368 is ideal for providing clock multiplication and jitter attenuation in high performance timing applications.

Applications

- SONET/SDH OC-48/OC-192 line cards
- GbE/10GbE, 1/2/4/8/10GFC line cards
- ITU G.709 and custom FEC line cards
- Wireless basestations
- Data converter clocking
- xDSL
- SONET/SDH + PDH clock synthesis
- Test and measurement

Features

- Generates any frequency from 2 kHz to 945 MHz and select frequencies to 1.4 GHz from an input frequency of 2 kHz to 710 MHz
- Ultra-low jitter clock outputs w/jitter generation as low as 0.3 ps rms (50 kHz–80 MHz)
- Integrated loop filter with selectable loop bandwidth (60 Hz to 8.4 kHz)
- Meets OC-192 GR-253-CORE jitter specifications
- Four clock inputs w/manual or automatically controlled hitless switching
- Five clock outputs with selectable signal format (LVPECL, LVDS, CML, CMOS)
- SONET frame sync switching and regeneration
- Support for ITU G.709 and custom FEC ratios (255/238, 255/237, 255/236)
- LOL, LOS, FOS alarm outputs
- Digitally-controlled output phase adjust
- I²C or SPI programmable settings
- On-chip voltage regulator for 1.8 or 2.5 V ±10% operation
- Small size: 14 x 14 mm 100-pin TQFP
- Pb-free, RoHS compliant

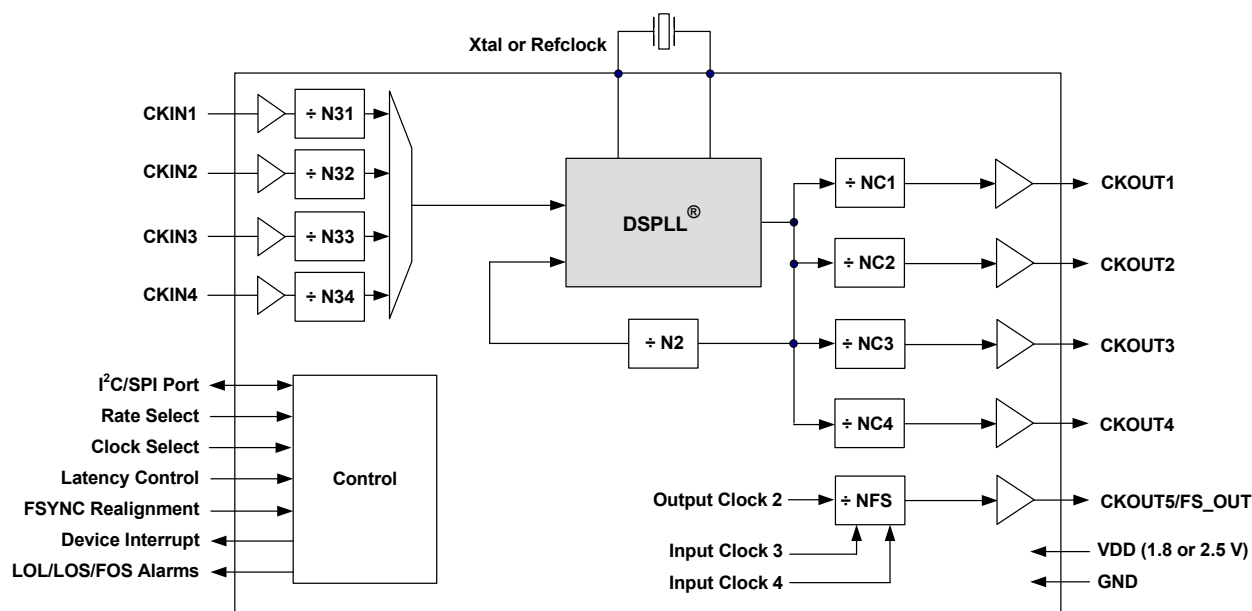

Table 1. Performance Specifications

($V_{DD} = 1.8$ or 2.5 V $\pm 10\%$, $T_A = -40$ to 85 °C)

Parameter	Symbol	Test Condition	Min	Typ	Max	Unit
Temperature Range	T_A		-40	25	85	°C
Supply Voltage	V_{DD}		2.25	2.5	2.75	V
			1.62	1.8	1.98	V
Supply Current	I_{DD}	$f_{OUT} = 622.08$ MHz All CKOUTs enabled LVPECL format output	—	394	435	mA
		Only CKOUT1 enabled	—	253	284	mA
		$f_{OUT} = 19.44$ MHz All CKOUTs enabled CMOS format output	—	278	321	mA
		Only CKOUT1 enabled	—	229	261	mA
		Tristate/Sleep Mode	—	TBD	TBD	mA
Input Clock Frequency (CKIN1, CKIN2, CKIN3, CKIN4)	CK_F	Input frequency and clock multiplication ratio determined by programming device PLL dividers. Consult Silicon Laboratories configuration software DSPLLsim or Any-Rate Precision Clock Family Reference Manual at www.silabs.com/timing to determine PLL divider settings for a given input frequency/clock multiplication ratio combination.	0.002	—	710	MHz
Input Clock Frequency (CKIN3, CKIN4 used as FSYNC inputs)	CK_F		0.002	—	0.512	MHz
Output Clock Frequency (CKOUT1, CKOUT2, CKOUT3, CKOUT4, CKOUT5 used as fifth high-speed output)	CK_{OF}		0.002	—	945	MHz
			970	—	1134	
CKOUT5 used as frame sync output (FS_OUT)	CK_{OF}		1213	—	1417	
			0.002	—	710	MHz
Input Clocks (CKIN1, CKIN2, CKIN3, CKIN4)						
Differential Voltage Swing	CKN_{DPP}		0.25	—	1.9	V_{PP}
Common Mode Voltage	CKN_{VCM}	1.8 V $\pm 10\%$	0.9	—	1.4	V
		2.5 V $\pm 10\%$	1.0	—	1.7	V
Rise/Fall Time	CKN_{TRF}	20–80%	—	—	11	ns
Duty Cycle	CKN_{DC}	Whichever is less	40	—	60	%
			50	—	—	ns
Note: For a more comprehensive listing of device specifications, please consult the Silicon Laboratories Any-Rate Precision Clock Family Reference Manual. This document can be downloaded from www.silabs.com/timing .						

Table 1. Performance Specifications (Continued) $(V_{DD} = 1.8 \text{ or } 2.5 \text{ V } \pm 10\%, T_A = -40 \text{ to } 85 \text{ }^\circ\text{C})$

Parameter	Symbol	Test Condition	Min	Typ	Max	Unit
Output Clocks (CKOUT1, CKOUT2, CKOUT3, CKOUT4, CKOUT5/FS_OUT)						
Common Mode	V_{OCM}	LVPECL 100 Ω load line-to-line	$V_{DD} - 1.42$	—	$V_{DD} - 1.25$	V
Differential Output Swing	V_{OD}		1.1	—	1.9	V_{DD}
Single Ended Output Swing	V_{SE}		0.5	—	0.93	Vpp
PLL Performance						
Jitter Generation	J_{GEN}	$f_{OUT} = 622.08 \text{ MHz}$, LVPECL output format 50 kHz–80 MHz	—	0.3	TBD	ps rms
		12 kHz–20 MHz	—	0.3	TBD	ps rms
Jitter Transfer	J_{PK}		—	0.05	0.1	dB
External Reference Jitter Transfer	J_{PKEXTN}		—	TBD	TBD	dB
Phase Noise	CKO_{PN}	$f_{OUT} = 622.08 \text{ MHz}$ 100 Hz offset	—	TBD	TBD	dBc/Hz
		1 kHz offset	—	TBD	TBD	dBc/Hz
		10 kHz offset	—	TBD	TBD	dBc/Hz
		100 kHz offset	—	TBD	TBD	dBc/Hz
		1 MHz offset	—	TBD	TBD	dBc/Hz
Subharmonic Noise	SP_{SUBH}	Phase Noise @ 100 kHz Offset	—	TBD	TBD	dBc
Spurious Noise	SP_{SPUR}	Max spur @ $n \times F3$ ($n \geq 1, n \times F3 < 100 \text{ MHz}$)	—	TBD	TBD	dBc
Package						
Thermal Resistance Junction to Ambient	θ_{JA}	Still Air	—	40	—	$^\circ\text{C/W}$
Note: For a more comprehensive listing of device specifications, please consult the Silicon Laboratories Any-Rate Precision Clock Family Reference Manual. This document can be downloaded from www.silabs.com/timing .						

155.52 MHz in, 622.08 MHz out

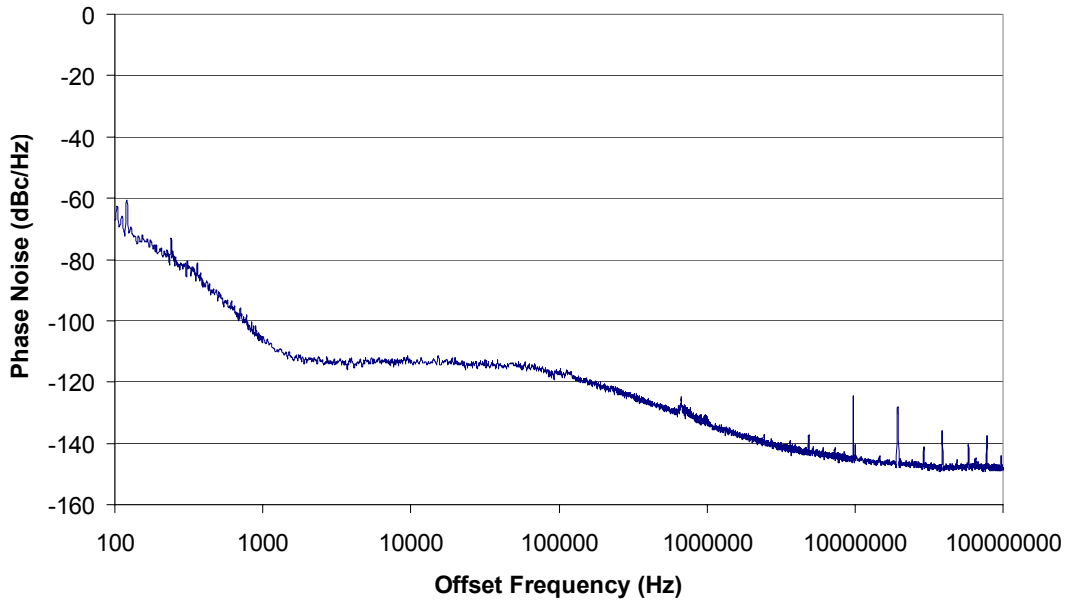

Figure 1. Typical Phase Noise Plot

Table 2. Absolute Maximum Ratings

Parameter	Symbol	Value	Unit
DC Supply Voltage	V_{DD}	-0.5 to 2.75	V
LVC MOS Input Voltage	V_{DIG}	-0.3 to ($V_{DD} + 0.3$)	V
Junction Temperature	T_{JCT}	-55 to 150	°C
Storage Temperature Range	T_{STG}	-55 to 150	°C
ESD HBM Tolerance (100 pF, 1.5 kΩ)		2	kV
ESD MM Tolerance		200	V
Latch-Up Tolerance		JESD78 Compliant	

Note: Permanent device damage may occur if the Absolute Maximum Ratings are exceeded. Functional operation should be restricted to the conditions as specified in the operation sections of this data sheet. Exposure to absolute maximum rating conditions for extended periods of time may affect device reliability.

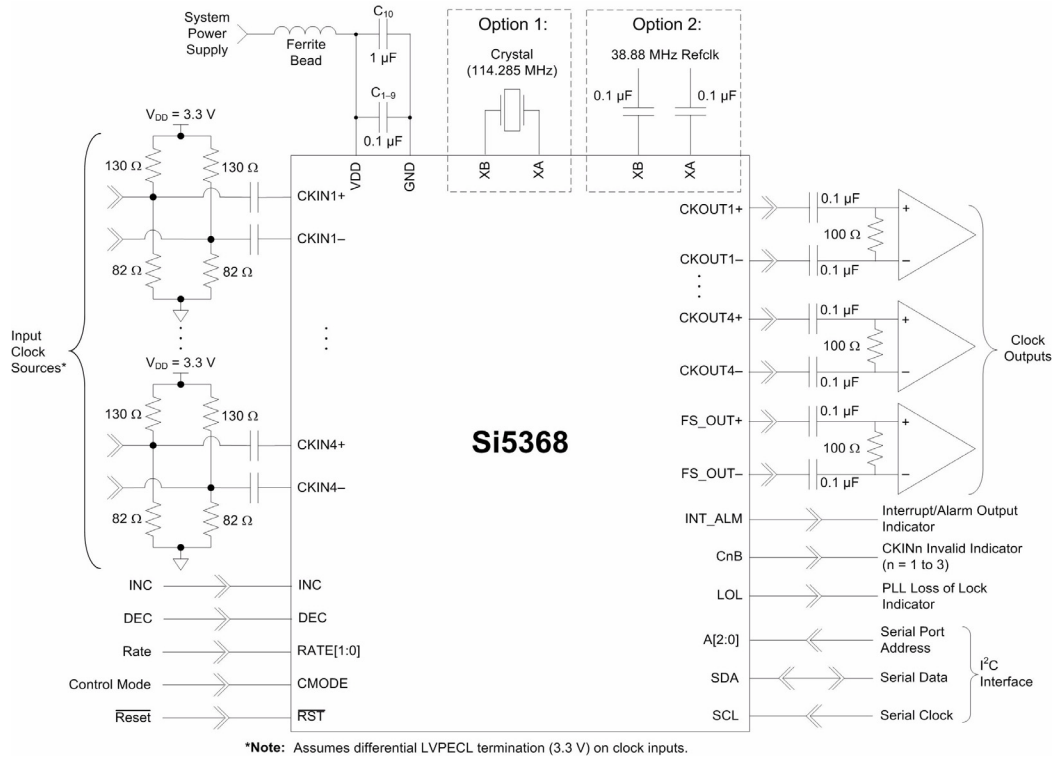

Figure 2. Si5368 Typical Application Circuit (I²C Control Mode)

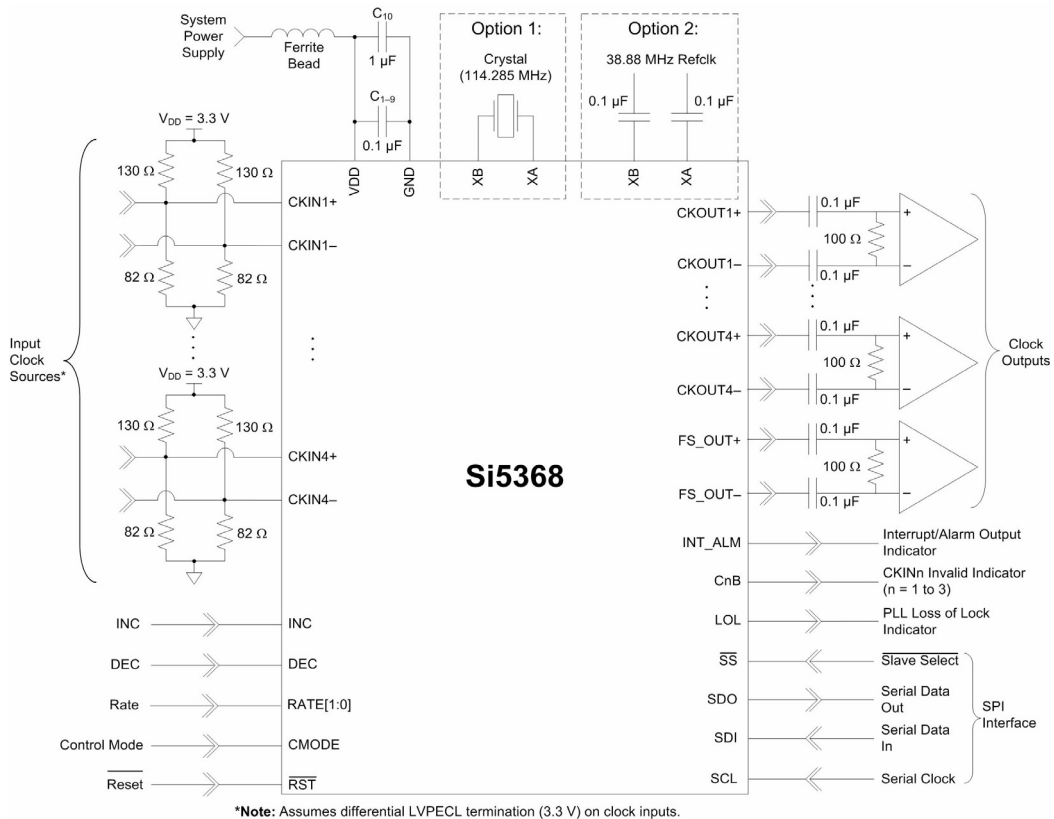

Figure 3. Si5368 Typical Application Circuit (SPI Control Mode)

1. Functional Description

The Si5368 is a jitter-attenuating precision clock multiplier for applications requiring sub 1 ps rms jitter performance. The Si5368 accepts four clock inputs ranging from 2 kHz to 710 MHz and generates five independent, synchronous clock outputs ranging from 2 kHz to 945 MHz and select frequencies to 1.4 GHz. The device provides virtually any frequency translation combination across this operating range. Independent dividers are available for every input clock and output clock, so the Si5368 can accept input clocks at different frequencies and it can generate output clocks at different frequencies. The Si5368 input clock frequency and clock multiplication ratio are programmable through an I²C or SPI interface. Optionally, the fifth clock output can be configured as a 2 to 512 kHz SONET/SDH frame synchronization output that is phase aligned with one of the high-speed output clocks. Silicon Laboratories offers a PC-based software utility, *DSPLLsim*, that can be used to determine the optimum PLL divider settings for a given input frequency/clock multiplication ratio combination that minimizes phase noise and power consumption. This utility can be downloaded from www.silabs.com/timing.

The Si5368 is based on Silicon Laboratories' 3rd-generation DSPLL[®] technology, which provides any-rate frequency synthesis and jitter attenuation in a highly integrated PLL solution that eliminates the need for external VCXO and loop filter components. The Si5368 PLL loop bandwidth is digitally programmable and supports a range from 60 Hz to 8.4 kHz. The *DSPLLsim* software utility can be used to calculate valid loop bandwidth settings for a given input clock frequency/clock multiplication ratio.

The Si5368 supports hitless switching between input clocks in compliance with GR-253-CORE and GR-1244-CORE that greatly minimizes the propagation of phase transients to the clock outputs during an input clock transition (<200 ps typ). Manual, automatic revertive and non-revertive input clock switching options are available. The Si5368 monitors the four input clocks for loss-of-signal and provides a LOS alarm when it detects missing pulses on any of the four input clocks. The device monitors the lock status of the PLL. The lock detect algorithm works by continuously monitoring the phase of the input clock in relation to the phase of the feedback clock. The Si5368 monitors the frequency of CKIN1, CKIN3, and CKIN4 with respect to a reference frequency applied to CKIN2, and generates a frequency offset alarm (FOS) if the threshold is exceeded. This FOS feature is available for SONET applications in which both the monitored frequency on CKIN1, CKIN3, and CKIN4 and the reference frequency are integer multiples of 19.44 MHz. Both Stratum 3/3E and SONET Minimum Clock (SMC) FOS thresholds are supported.

The Si5368 provides a digital hold capability that allows

the device to continue generation of a stable output clock when the selected input reference is lost. During digital hold, the DSPLL generates an output frequency based on a historical average that existed a fixed amount of time before the error event occurred, eliminating the effects of phase and frequency transients that may occur immediately preceding digital hold.

Fine phase adjustment is available and is set using the FLAT register bits. The nominal range and resolution of the FLAT[14:0] latency adjustment word are: ±110 ps and 3.05 ps, respectively.

The Si5368 has five differential clock outputs. The electrical format of the clock outputs is programmable to support LVPECL, LVDS, CML, or CMOS loads. If not required, unused clock outputs can be powered down to minimize power consumption. The phase difference between the selected input clock and the output clocks is adjustable in 200 ps increments for system skew control. In addition, the phase of one output clock may be adjusted in relation to the phase of the other output clock. The resolution varies from 800 ps to 2.2 ns depending on the PLL divider settings. Consult the *DSPLLsim* configuration software to determine the phase offset resolution for a given input clock/clock multiplication ratio combination. For system-level debugging, a bypass mode is available which drives the output clock directly from the input clock, bypassing the internal DSPLL. The device is powered by a single 1.8 or 2.5 V supply.

1.1. External Reference

An external, 38.88 MHz clock or a low-cost 114.285 MHz 3rd overtone crystal is used as part of a fixed-frequency oscillator within the DSPLL. This external reference is required for the device to perform jitter attenuation. Silicon Laboratories recommends using a high-quality crystal from TXC (www.txc.com.tw), part number 7MA1400014. An external 38.88 MHz clock from a high quality OCXO or TCXO can also be used as a reference for the device.

In digital hold, the DSPLL remains locked to this external reference. Any changes in the frequency of this reference when the DSPLL is in digital hold, will be tracked by the output of the device. Note that crystals can have temperature sensitivities.

1.2. Further Documentation

Consult the Silicon Laboratories Any-Rate Precision Clock Family Reference Manual (FRM) for more detailed information about the Si5368. The FRM can be downloaded from www.silabs.com/timing.

Silicon Laboratories has developed a PC-based software utility called *DSPLLsim* to simplify device configuration, including frequency planning and loop bandwidth selection. This utility can be downloaded from www.silabs.com/timing.

2. Pin Descriptions: Si5368

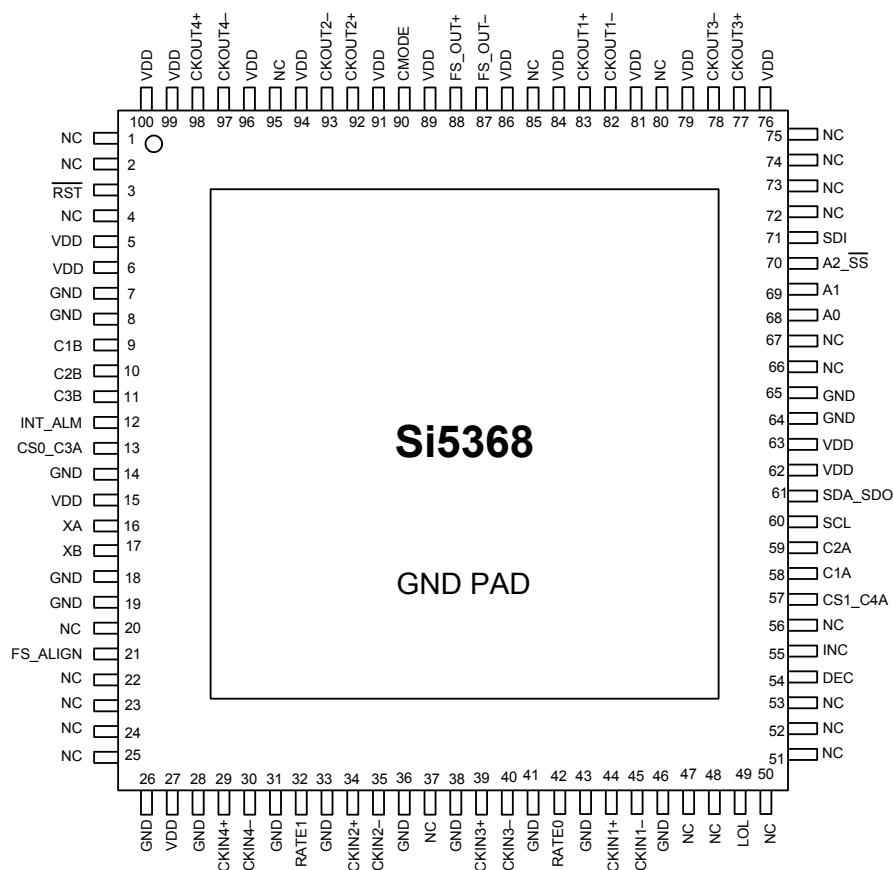

Table 3. Si5368 Pin Descriptions

Pin #	Pin Name	I/O	Signal Level	Description
1, 2, 4, 20, 22, 23, 24, 25, 37, 47, 48, 50, 51, 52, 53, 56, 66, 67, 72, 73, 74, 75, 80, 85, 95	NC			No Connect. These pins must be left unconnected for normal operation.
3	$\overline{\text{RST}}$	I	LVCMOS	External Reset. Active low input that performs external hardware reset of device. Resets all internal logic to a known state and forces the device registers to their default value. Clock outputs are tristated during reset. After rising edge of $\overline{\text{RST}}$ signal, the device will perform an internal self-calibration. This pin has a weak pull-up.
Note: Internal register names are indicated by underlined italics, e.g. <i>INT_PIN</i> . See Si5368 Register Map.				

Table 3. Si5368 Pin Descriptions (Continued)

Pin #	Pin Name	I/O	Signal Level	Description																				
5, 6, 15, 27, 62, 63, 76, 79, 81, 84, 86, 89, 91, 94, 96, 99, 100	V _{DD}	Vdd	Supply	<p>V_{DD}. The device operates from a 1.8 or 2.5 V supply. Bypass capacitors should be associated with the following V_{DD} pins:</p> <table> <thead> <tr> <th>Pins</th> <th>Bypass Cap</th> </tr> </thead> <tbody> <tr> <td>5, 6</td> <td>0.1 μF</td> </tr> <tr> <td>15</td> <td>0.1 μF</td> </tr> <tr> <td>27</td> <td>0.1 μF</td> </tr> <tr> <td>62, 63</td> <td>0.1 μF</td> </tr> <tr> <td>76, 79</td> <td>1.0 μF</td> </tr> <tr> <td>81, 84</td> <td>0.1 μF</td> </tr> <tr> <td>86, 89</td> <td>0.1 μF</td> </tr> <tr> <td>91, 94</td> <td>0.1 μF</td> </tr> <tr> <td>96, 99, 100</td> <td>0.1 μF</td> </tr> </tbody> </table>	Pins	Bypass Cap	5, 6	0.1 μF	15	0.1 μF	27	0.1 μF	62, 63	0.1 μF	76, 79	1.0 μF	81, 84	0.1 μF	86, 89	0.1 μF	91, 94	0.1 μF	96, 99, 100	0.1 μF
Pins	Bypass Cap																							
5, 6	0.1 μF																							
15	0.1 μF																							
27	0.1 μF																							
62, 63	0.1 μF																							
76, 79	1.0 μF																							
81, 84	0.1 μF																							
86, 89	0.1 μF																							
91, 94	0.1 μF																							
96, 99, 100	0.1 μF																							
7, 8, 14, 18, 19, 26, 28, 31, 33, 36, 38, 41, 43, 46, 64, 65	GND	GND	Supply	<p>Ground. This pin must be connected to system ground. Minimize the ground path impedance for optimal performance.</p>																				
9	C1B	O	LVC MOS	<p>CKIN1 Invalid Indicator. This pin performs the <u>CK1_BAD</u> function if <u>CK1_BAD_PIN</u> = 1 and is tristated if <u>CK1_BAD_PIN</u> = 0. Active polarity is controlled by <u>CK_BAD_POL</u>. 0 = No alarm on CKIN1. 1 = Alarm on CKIN1.</p>																				
10	C2B	O	LVC MOS	<p>CKIN2 Invalid Indicator. This pin performs the <u>CK2_BAD</u> function if <u>CK2_BAD_PIN</u> = 1 and is tristated if <u>CK2_BAD_PIN</u> = 0. Active polarity is controlled by <u>CK_BAD_POL</u>. 0 = No alarm on CKIN2. 1 = Alarm on CKIN2.</p>																				
11	C3B	O	LVC MOS	<p>CKIN3 Invalid Indicator. This pin performs the <u>CK3_BAD</u> function if <u>CK3_BAD_PIN</u> = 1 and is tristated if <u>CK3_BAD_PIN</u> = 0. Active polarity is controlled by <u>CK_BAD_POL</u>. 0 = No alarm on CKIN3. 1 = Alarm on CKIN3.</p>																				
12	INT_ALM	O	LVC MOS	<p>Interrupt/Alarm Output Indicator. This pin functions as a maskable interrupt output with active polarity controlled by the <u>INT_POL</u> register bit. The INT output function can be turned off by setting <u>INT_PIN</u> = 0. If the ALRMOUT function is desired instead on this pin, set <u>ALRMOUT_PIN</u> = 1 and <u>INT_PIN</u> = 0. 0 = <u>ALRMOUT</u> not active. 1 = <u>ALRMOUT</u> active. The active polarity is controlled by <u>CK_BAD_POL</u>. If no function is selected, the pin tristates.</p>																				
<p>Note: Internal register names are indicated by underlined italics, e.g. <u>INT_PIN</u>. See Si5368 Register Map.</p>																								

Table 3. Si5368 Pin Descriptions (Continued)

Pin #	Pin Name	I/O	Signal Level	Description										
13 57	CS0_C3A CS1_C4A	I/O	LVC MOS	<p>Input Clock Select/CKIN3 or CKIN4 Active Clock Indicator. If manual clock selection is chosen, and if <u>CKSEL_PIN</u> = 1, the CKSEL pins control clock selection and the <u>CKSEL_REG</u> bits are ignored.</p> <table border="1"> <thead> <tr> <th>CS[1:0]</th> <th>Active Input Clock</th> </tr> </thead> <tbody> <tr> <td>00</td> <td>CKIN1</td> </tr> <tr> <td>01</td> <td>CKIN2</td> </tr> <tr> <td>10</td> <td>CKIN3</td> </tr> <tr> <td>11</td> <td>CKIN4</td> </tr> </tbody> </table> <p>If <u>CKSEL_PIN</u> = 0, the <u>CKSEL_REG</u> register bits control this function and these inputs tristate. If these pins are not functioning as the CS[1:0] inputs and auto clock selection is enabled, then they serve as the CKIN_n active clock indicator. 0 = CKIN3 (CKIN4) is not the active input clock 1 = CKIN3 (CKIN4) is currently the active input to the PLL The <u>CKn_ACTV_REG</u> bit always reflects the active clock status for CKIN_n. If <u>CKn_ACTV_PIN</u> = 1, this status will also be reflected on the CnA pin with active polarity controlled by the <u>CK_ACTV_POL</u> bit. If <u>CKn_ACTV_PIN</u> = 0, this output tristates. This pin has a weak pull-down.</p>	CS[1:0]	Active Input Clock	00	CKIN1	01	CKIN2	10	CKIN3	11	CKIN4
CS[1:0]	Active Input Clock													
00	CKIN1													
01	CKIN2													
10	CKIN3													
11	CKIN4													
16 17	XA XB	I	ANALOG	<p>External Crystal or Reference Clock. External crystal should be connected to these pins to use external oscillator based reference. If a single-ended external reference is used, ac couple reference clock to XA input and leave XB pin floating. External reference must be from a high-quality clock source (TCXO, OCXO). Frequency of crystal or external clock is set by the RATE pins.</p>										
21	FS_ALIGN	I	LVC MOS	<p>FSYNC Alignment Control. If <u>FSYNC_ALIGN_PIN</u> = 1 and <u>CK_CONFIG</u> = 1, a logic high on this pin causes the FS_OUT phase to be realigned to the rising edge of the currently active input sync (CKIN_3 or CKIN_4). If <u>FSYNC_ALIGN_PIN</u> = 0, this pin is ignored and the <u>FSYNC_ALIGN_REG</u> bit performs this function. 0 = No realignment. 1 = Realign. This pin has a weak pull-down.</p>										
29 30	CKIN4+ CKIN4-	I	MULTI	<p>Clock Input 4. Differential clock input. This input can also be driven with a single-ended signal. CKIN4 serves as the frame sync input associated with the CKIN2 clock when <u>CK_CONFIG_REG</u> = 1.</p>										
<p>Note: Internal register names are indicated by underlined italics, e.g. <u>INT_PIN</u>. See Si5368 Register Map.</p>														

Table 3. Si5368 Pin Descriptions (Continued)

Pin #	Pin Name	I/O	Signal Level	Description
32 42	RATE1 RATE0	I	3-Level	<p>External Crystal or Reference Clock Rate. Three level inputs that select the type and rate of external crystal or reference clock to be applied to the XA/XB port. Settings: HH = No Crystal or Reference Clock. Converts part to a Si5367 device. See Si5367 Data Sheet for operation. (Wideband). MM = 114.285 MHz 3rd OT crystal (Narrowband). LM = 38.88 MHz external clock (Narrowband). All others = Reserved.</p>
34 35	CKIN2+ CKIN2-	I	MULTI	<p>Clock Input 2. Differential input clock. This input can also be driven with a single-ended signal.</p>
39 40	CKIN3+ CKIN3-	I	MULTI	<p>Clock Input 3. Differential clock input. This input can also be driven with a single-ended signal. CKIN3 serves as the frame sync input associated with the CKIN1 clock when <u>CK_CONFIG_REG</u> = 1.</p>
44 45	CKIN1+ CKIN1-	I	MULTI	<p>Clock Input 1. Differential clock input. This input can also be driven with a single-ended signal.</p>
49	LOL	O	LVC MOS	<p>PLL Loss of Lock Indicator. This pin functions as the active high PLL loss of lock indicator if the <u>LOL_PIN</u> register bit is set to one. 0 = PLL locked. 1 = PLL unlocked. If LOL_PIN = 0, this pin will tristate. Active polarity is controlled by the <u>LOL_POL</u> bit. The PLL lock status will always be reflected in the <u>LOL_INT</u> read only register bit.</p>
54	DEC	I	LVC MOS	<p>Coarse Latency Decrement. A pulse on this pin decreases the input to output device latency by 1/fOSC (approximately 200 ps). Detailed operations and timing characteristics for this pin may be found in the Any-Rate Precision Clock Family Reference Manual. There is no limit on the range of latency adjustment by this method. Pin control is enabled by setting <u>INCDEC_PIN</u> = 1 (default). If <u>INCDEC_PIN</u> = 0, this pin is ignored and coarse output latency is controlled via the CLAT register. If both INC and DEC are tied high, phase buildout is disabled and the device maintains a fixed-phase relationship between the selected input clock and the output clock during an input clock switch. Detailed operations and timing characteristics for these pins may be found in the Any-Rate Precision Clock Family Reference Manual. This pin has a weak pull-down.</p>
<p>Note: Internal register names are indicated by underlined italics, e.g. <u>INT_PIN</u>. See Si5368 Register Map.</p>				

Table 3. Si5368 Pin Descriptions (Continued)

Pin #	Pin Name	I/O	Signal Level	Description
55	INC	I	LVC MOS	<p>Coarse Latency Increment. A pulse on this pin increases the input to output device latency by $1/f_{OSC}$ (approximately 200 ps). Detailed operations and timing characteristics for this pin may be found in the Any-Rate Precision Clock Family Reference Manual. There is no limit on the range of latency adjustment by this method. Pin control is enabled by setting <u>INCDEC_PIN</u> = 1 (default). If <u>INCDEC_PIN</u> = 0, this pin is ignored and coarse output latency is controlled via the <u>CLAT</u> register. If both INC and DEC are tied high, phase buildout is disabled and the device maintains a fixed-phase relationship between the selected input clock and the output clock during an input clock switch. Detailed operations and timing characteristics for these pins may be found in the Any-Rate Precision Clock Family Reference Manual. This pin has a weak pull-down.</p>
58	C1A	O	LVC MOS	<p>CKIN1 Active Clock Indicator. This pin serves as the CKIN1 active clock indicator. The <u>CK1_ACTV_REG</u> bit always reflects the active clock status for CKIN1. If <u>CK1_ACTV_PIN</u> = 1, this status will also be reflected on the C1A pin with active polarity controlled by the <u>CK_ACTV_POL</u> bit. If <u>CK1_ACTV_PIN</u> = 0, this output tristates.</p>
59	C2A	O	LVC MOS	<p>CKIN2 Active Clock Indicator. This pin serves as the CKIN2 active clock indicator. The <u>CK2_ACTV_REG</u> bit always reflects the active clock status for CKIN_2. If <u>CK2_ACTV_PIN</u> = 1, this status will also be reflected on the C2A pin with active polarity controlled by the <u>CK_ACTV_POL</u> bit. If <u>CK2_ACTV_PIN</u> = 0, this output tristates.</p>
60	SCL	I	LVC MOS	<p>Serial Clock. This pin functions as the serial port clock input for both SPI and I²C modes. This pin has a weak pull-down.</p>
61	SDA_SDO	I/O	LVC MOS	<p>Serial Data. In I²C microprocessor control mode (CMODE = 0), this pin functions as the bidirectional serial data port. In SPI microprocessor control mode (CMODE = 1), this pin functions as the serial data output.</p>
68 69	A0 A1	I	LVC MOS	<p>Serial Port Address. In I²C microprocessor control mode (CMODE = 0), these pins function as hardware controlled address bits. In SPI microprocessor control mode (CMODE = 1), these pins are ignored. This pin has a weak pull-down.</p>
70	A2 _{SS}	I	LVC MOS	<p>Serial Port Address/Slave Select. In I²C microprocessor control mode (CMODE = 0), this pin functions as a hardware controlled address bit. In SPI microprocessor control mode (CMODE = 1), this pin functions as the slave select input. This pin has a weak pull-down.</p>

Note: Internal register names are indicated by underlined italics, e.g. INT_PIN. See Si5368 Register Map.

Table 3. Si5368 Pin Descriptions (Continued)

Pin #	Pin Name	I/O	Signal Level	Description
71	SDI	I	LVC MOS	Serial Data In. In SPI microprocessor control mode (CMODE = 1), this pin functions as the serial data input. In I ² C microprocessor control mode (CMODE = 0), this pin is ignored. This pin has a weak pull-down.
77 78	CKOUT3+ CKOUT3-	O	MULTI	Clock Output 3. Differential clock output. Output signal format is selected by <u>SFOUT3_REG</u> register bits. Output is differential for LVPECL, LVDS, and CML compatible modes. For CMOS format, both output pins drive identical single-ended clock outputs.
82 83	CKOUT1- CKOUT1+	O	MULTI	Clock Output 1. Differential clock output. Output signal format is selected by <u>SFOUT1_REG</u> register bits. Output is differential for LVPECL, LVDS, and CML compatible modes. For CMOS format, both output pins drive identical single-ended clock outputs.
87 88	FS_OUT- FS_OUT+	O	MULTI	Frame Sync Output. Differential frame sync output or fifth high-speed clock output. Output signal format is selected by <u>SFOUT_FSYNC_REG</u> register bits. Output is differential for LVPECL, LVDS, and CML compatible modes. For CMOS format, both output pins drive identical single-ended clock outputs. Duty cycle and active polarity are controlled by <u>FSYNC_PW</u> and <u>FSYNC_POL</u> bits, respectively. Detailed operations and timing characteristics for these pins may be found in the Any-Rate Precision Clock Family Reference Manual.
90	CMODE	I	LVC MOS	Control Mode. Selects I ² C or SPI control mode for the device. 0 = I ² C Control Mode. 1 = SPI Control Mode.
92 93	CKOUT2+ CKOUT2-	O	MULTI	Clock Output 2. Differential clock output. Output signal format is selected by <u>SFOUT2_REG</u> register bits. Output is differential for LVPECL, LVDS, and CML compatible modes. For CMOS format, both output pins drive identical single-ended clock outputs.
97 98	CKOUT4- CKOUT4+	O	MULTI	Clock Output 4. Differential clock output. Output signal format is selected by <u>SFOUT4_REG</u> register bits. Output is differential for LVPECL, LVDS, and CML compatible modes. For CMOS format, both output pins drive identical single-ended clock outputs.
GND PAD	GND PAD	GND	Supply	Ground Pad. The ground pad must provide a low thermal and electrical impedance to a ground plane.

Note: Internal register names are indicated by underlined italics, e.g. INT_PIN. See Si5368 Register Map.

3. Ordering Guide

Ordering Part Number	Output Clock Frequency Range	Package	Temperature Range
Si5368A-B-GQ	2 kHz–945 MHz 970–1134 MHz 1.213–1.417 GHz	100-Pin 14 x 14 mm TQFP	–40 to 85 °C
Si5368B-B-GQ	2 kHz–808 MHz	100-Pin 14 x 14 mm TQFP	–40 to 85 °C
Si5368C-B-GQ	2 kHz–346 MHz	100-Pin 14 x 14 mm TQFP	–40 to 85 °C

4. Package Outline: 100-Pin TQFP

Figure 4 illustrates the package details for the Si5368. Table 4 lists the values for the dimensions shown in the illustration.

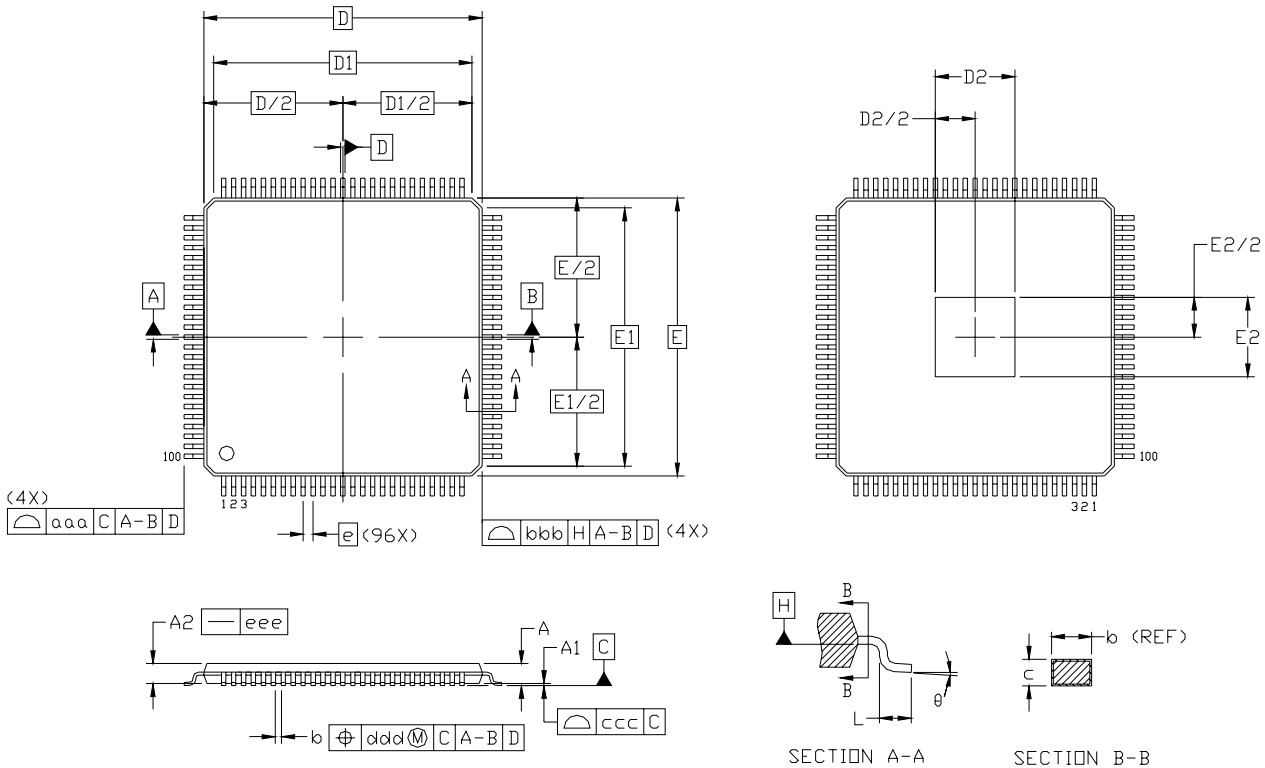

Figure 4. 100-Pin Thin Quad Flat Package (TQFP)

Table 4. 100-Pin Package Diagram Dimensions

Dimension	Min	Nom	Max	Dimension	Min	Nom	Max
A	—	—	1.20	E	16.00 BSC.		
A1	0.05	—	0.15	E1	14.00 BSC.		
A2	0.95	1.00	1.05	E2	3.85	4.00	4.15
b	0.17	0.22	0.27	L	0.45	0.60	0.75
c	0.09	—	0.20	aaa	—	—	0.20
D	16.00 BSC.			bbb	—	—	0.20
D1	14.00 BSC.			ccc	—	—	0.08
D2	3.85	4.00	4.15	ddd	—	—	0.08
e	0.50 BSC.			theta	0°	3.5°	7°

Notes:

1. All dimensions shown are in millimeters (mm) unless otherwise noted.
2. Dimensioning and Tolerancing per ANSI Y14.5M-1994.
3. This package outline conforms to JEDEC MS-026, variant AED-HD.
4. Recommended card reflow profile is per the JEDEC/IPC J-STD-020C specification for Small Body Components.

5. Recommended PCB Layout

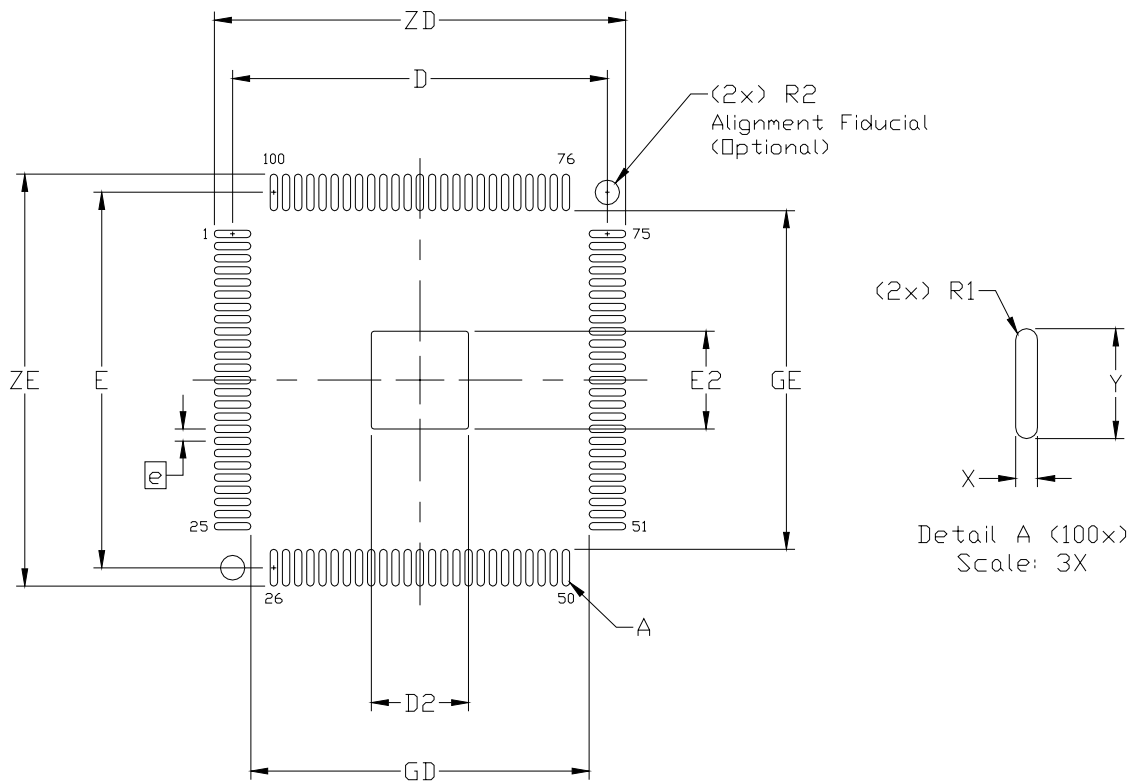

Figure 5. PCB Land Pattern Diagram

Table 5. PCB Land Pattern Dimensions

Dimension	MIN	MAX
e	0.50 BSC.	
E	15.40 REF.	
D	15.40 REF.	
E2	3.90	4.10
D2	3.90	4.10
GE	13.90	—
GD	13.90	—
X	—	0.30
Y	1.50 REF.	
ZE	—	16.90
ZD	—	16.90
R1	0.15 REF	
R2	—	1.00

Notes (General):

1. All dimensions shown are in millimeters (mm) unless otherwise noted.
2. Dimensioning and Tolerancing is per the ANSI Y14.5M-1994 specification.
3. This Land Pattern Design is based on IPC-7351 guidelines.
4. All dimensions shown are at Maximum Material Condition (MMC). Least Material Condition (LMC) is calculated based on a Fabrication Allowance of 0.05 mm.

Notes (Solder Mask Design):

1. All metal pads are to be non-solder mask defined (NSMD). Clearance between the solder mask and the metal pad is to be 60 μm minimum, all the way around the pad.

Notes (Stencil Design):

1. A stainless steel, laser-cut and electro-polished stencil with trapezoidal walls should be used to assure good solder paste release.
2. The stencil thickness should be 0.125 mm (5 mils).
3. The ratio of stencil aperture to land pad size should be 1:1 for the perimeter pads.
4. A 4 x 4 array of 0.80 mm square openings on 1.05 mm pitch should be used for the center ground pad.

Notes (Card Assembly):

1. A No-Clean, Type-3 solder paste is recommended.
2. The recommended card reflow profile is per the JEDEC/IPC J-STD-020C specification for Small Body Components.

DOCUMENT CHANGE LIST

Revision 0.1 to Revision 0.2

- Changed LVTTTL to LVCMOS in Table 2, “Absolute Maximum Ratings,” on page 4.
- Updated Figure 2 and Figure 3 on page 5.
- Updated “2. Pin Descriptions: Si5368”.
 - Added RATE0 to pin description. By changing RATE[1:0] the part can emulate a Si5367.
 - Changed XA/XB pin description to support both differential and single ended external REFCLK.

Revision 0.2 to Revision 0.3

- Added Figure 1, “Typical Phase Noise Plot,” on page 4.
- Updated Figure 2, “Si5368 Typical Application Circuit (I²C Control Mode),” and Figure 3, “Si5368 Typical Application Circuit (SPI Control Mode),” on page 5 to show INC and DEC.
- Updated “2. Pin Descriptions: Si5368”.
 - Changed font of register names to *underlined italics*.
- Updated “3. Ordering Guide” on page 13.
- Added “5. Recommended PCB Layout”.

CONTACT INFORMATION

Silicon Laboratories Inc.

400 West Cesar Chavez

Austin, TX 78701

Tel: 1+(512) 416-8500

Fax: 1+(512) 416-9669

Toll Free: 1+(877) 444-3032

Email: Clockinfo@silabs.com

Internet: www.silabs.com

The information in this document is believed to be accurate in all respects at the time of publication but is subject to change without notice. Silicon Laboratories assumes no responsibility for errors and omissions, and disclaims responsibility for any consequences resulting from the use of information included herein. Additionally, Silicon Laboratories assumes no responsibility for the functioning of undescribed features or parameters. Silicon Laboratories reserves the right to make changes without further notice. Silicon Laboratories makes no warranty, representation or guarantee regarding the suitability of its products for any particular purpose, nor does Silicon Laboratories assume any liability arising out of the application or use of any product or circuit, and specifically disclaims any and all liability, including without limitation consequential or incidental damages. Silicon Laboratories products are not designed, intended, or authorized for use in applications intended to support or sustain life, or for any other application in which the failure of the Silicon Laboratories product could create a situation where personal injury or death may occur. Should Buyer purchase or use Silicon Laboratories products for any such unintended or unauthorized application, Buyer shall indemnify and hold Silicon Laboratories harmless against all claims and damages.

Silicon Laboratories, Silicon Labs, and DSPLL are trademarks of Silicon Laboratories Inc.

Other products or brandnames mentioned herein are trademarks or registered trademarks of their respective holders.