

Features

- Zero input-output propagation delay, adjustable by capacitive load on FBK input
- Multiple configurations, see [Available CY2308 Configurations](#) on page 3
- Multiple low skew outputs
- Two banks of four outputs, three-stateable by two select inputs
- 10 MHz to 133 MHz operating range
- 75 ps typical cycle-to-cycle jitter (15 pF, 66 MHz)
- Space saving 16-pin 150 mil SOIC package or 16-pin TSSOP
- 3.3V operation
- Industrial temperature available

Functional Description

The CY2308 is a 3.3V Zero Delay Buffer designed to distribute high speed clocks in PC, workstation, datacom, telecom, and other high performance applications.

The part has an on-chip PLL that locks to an input clock presented on the REF pin. The PLL feedback is driven into the FBK pin and obtained from one of the outputs. The input-to-output skew is less than 350 ps and output-to-output skew is less than 200 ps.

The CY2308 has two banks of four outputs each that is controlled by the select inputs as shown in the table [Select Input Decoding](#) on page 2. If all output clocks are not required, Bank B is three-stated. The input clock is directly applied to the output for chip and system testing purposes by the select inputs.

The CY2308 PLL enters a power down state when there are no rising edges on the REF input. In this mode, all outputs are three-stated and the PLL is turned off resulting in less than 50 μ A of current draw. The PLL shuts down in two additional cases as shown in the table [Select Input Decoding](#) on page 2.

Multiple CY2308 devices accept the same input clock and distribute it in a system. In this case, the skew between the outputs of two devices is less than 700 ps.

The CY2308 is available in five different configurations as shown in the table [Available CY2308 Configurations](#) on page 3. The CY2308-1 is the base part where the output frequencies equal the reference if there is no counter in the feedback path. The CY2308-1H is the high drive version of the -1 and rise and fall times on this device are much faster.

The CY2308-2 enables the user to obtain 2X and 1X frequencies on each output bank. The exact configuration and output frequencies depend on the output that drives the feedback pin. The CY2308-3 enables the user to obtain 4X and 2X frequencies on the outputs.

The CY2308-4 enables the user to obtain 2X clocks on all outputs. Thus, the part is extremely versatile and is used in a variety of applications.

The CY2308-5H is a high drive version with REF/2 on both banks.

Logic Block Diagram

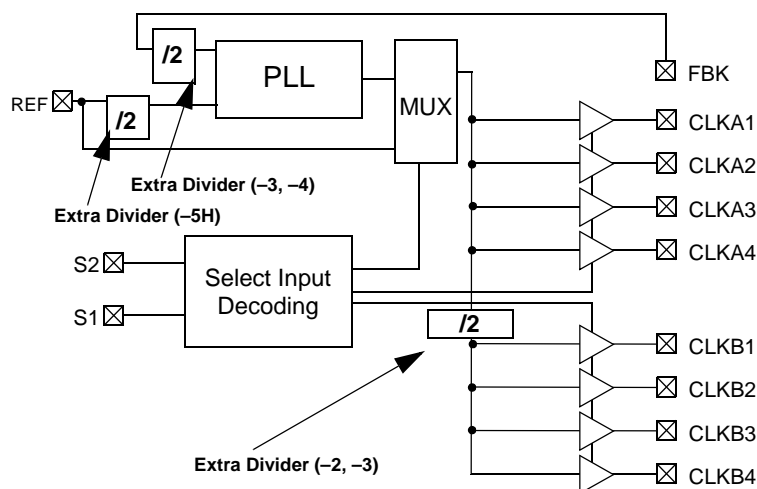

Pinouts

Figure 1. Pin Diagram - 16 Pin SOIC (Top view)

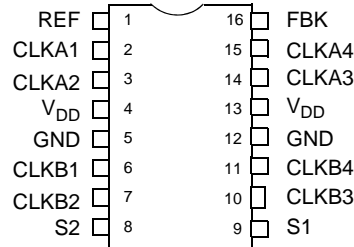

Table 1. Pin Definitions - 16 Pin SOIC

Pin	Signal	Description
1	REF ^[1]	Input reference frequency, 5V tolerant input
2	CLKA1 ^[2]	Clock output, Bank A
3	CLKA2 ^[2]	Clock output, Bank A
4	V _{DD}	3.3V supply
5	GND	Ground
6	CLKB1 ^[2]	Clock output, Bank B
7	CLKB2 ^[2]	Clock output, Bank B
8	S2 ^[3]	Select input, bit 2
9	S1 ^[3]	Select input, bit 1
10	CLKB3 ^[2]	Clock output, Bank B
11	CLKB4 ^[2]	Clock output, Bank B
12	GND	Ground
13	V _{DD}	3.3V supply
14	CLKA3 ^[2]	Clock output, Bank A
15	CLKA4 ^[2]	Clock output, Bank A
16	FBK	PLL feedback input

Select Input Decoding

S2	S1	CLOCK A1–A4	CLOCK B1–B4	Output Source	PLL Shutdown
0	0	Tri-State	Tri-State	PLL	Y
0	1	Driven	Tri-State	PLL	N
1	0	Driven ^[4]	Driven ^[4]	Reference	Y
1	1	Driven	Driven	PLL	N

Notes

1. Weak pull down.
2. Weak pull down on all outputs.
3. Weak pull ups on these inputs.
4. Outputs inverted on 2308–2 and 2308–3 in bypass mode, S2 = 1 and S1 = 0.

Available CY2308 Configurations

Device	Feedback From	Bank A Frequency	Bank B Frequency
CY2308-1	Bank A or Bank B	Reference	Reference
CY2308-1H	Bank A or Bank B	Reference	Reference
CY2308-2	Bank A	Reference	Reference/2
CY2308-2	Bank B	2 X Reference	Reference
CY2308-3	Bank A	2 X Reference	Reference or Reference ^[5]
CY2308-3	Bank B	4 X Reference	2 X Reference
CY2308-4	Bank A or Bank B	2 X Reference	2 X Reference
CY2308-5H	Bank A or Bank B	Reference /2	Reference /2

Zero Delay and Skew Control

Figure 2. REF. Input to CLKA/CLKB Delay Versus Difference in Loading between FBK Pin and CLKA/CLKB Pins

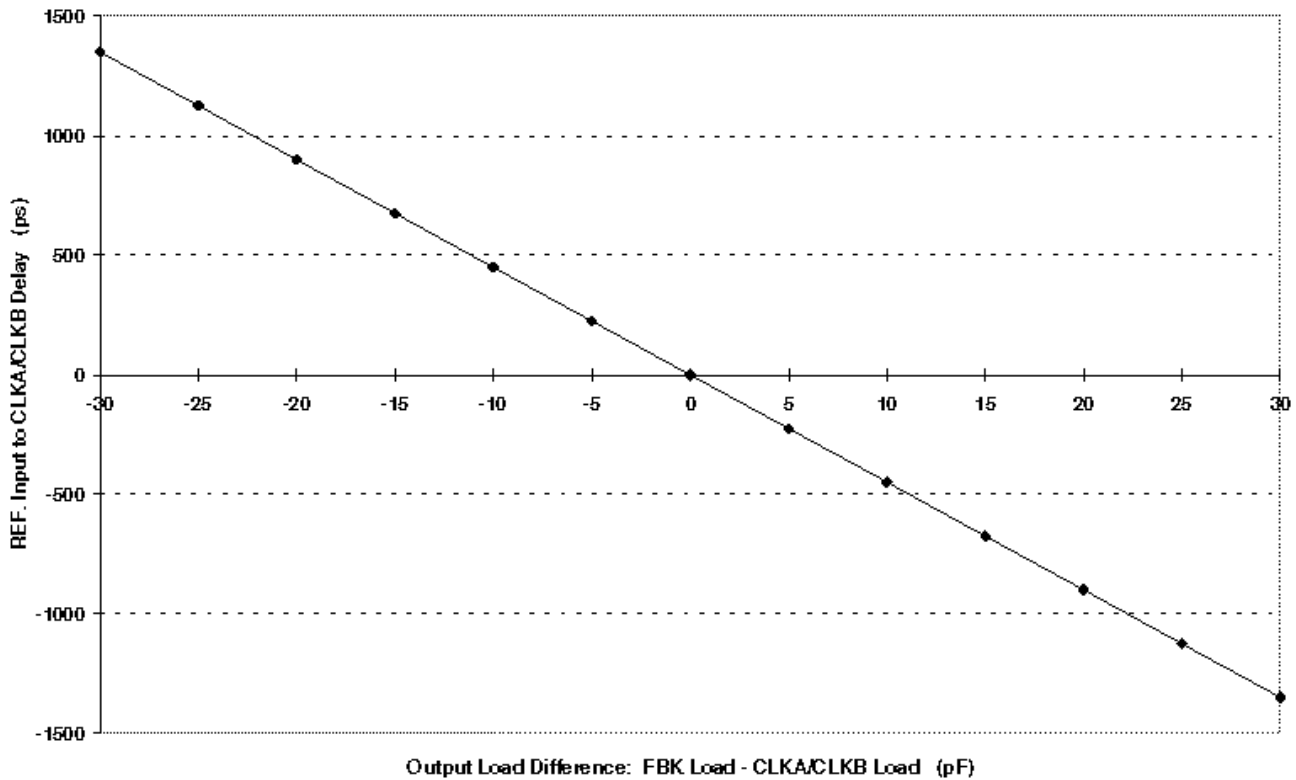

To close the feedback loop of the CY2308, the FBK pin is driven from any of the eight available output pins. The output driving the FBK pin drives a total load of 7 pF plus any additional load that it drives. The relative loading of this output to the remaining outputs adjusts the input-output delay. This is shown in the Figure 2.

For applications requiring zero input-output delay, all outputs including the one providing feedback is equally loaded.

If input-output delay adjustments are required, use the [Zero Delay and Skew Control](#) graph to calculate loading differences between the feedback output and remaining outputs.

For zero output-output skew, outputs are loaded equally. For further information on using CY2308, refer to the application note "CY2308: Zero Delay Buffer."

Note

5. Output phase is indeterminant (0° or 180° from input clock). If phase integrity is required, use the CY2308-2.

Maximum Ratings

Supply Voltage to Ground Potential.....	-0.5V to +7.0V	Junction Temperature.....	150°C
DC Input Voltage (Except Ref)	-0.5V to $V_{DD} + 0.5V$	Static Discharge Voltage (MIL-STD-883, Method 3015).....	>2000V
DC Input Voltage REF	-0.5 to 7V		
Storage Temperature	-65°C to +150°C		

Operating Conditions for Commercial Temperature Devices

Parameter	Description	Min	Max	Unit
V_{DD}	Supply Voltage	3.0	3.6	V
T_A	Operating Temperature (Ambient Temperature)	0	70	°C
C_L	Load Capacitance, below 100 MHz	-	30	pF
	Load Capacitance, from 100 MHz to 133 MHz	-	15	pF
C_{IN}	Input Capacitance ^[6]	-	7	pF
t_{PU}	Power up time for all V_{DD} s to reach minimum specified voltage (power ramps must be monotonic)	0.05	50	ms

Electrical Characteristics for Commercial Temperature Devices

Parameter	Description	Test Conditions	Min	Max	Unit
V_{IL}	Input LOW Voltage		-	0.8	V
V_{IH}	Input HIGH Voltage		2.0	-	V
I_{IL}	Input LOW Current	$V_{IN} = 0V$	-	50.0	μA
I_{IH}	Input HIGH Current	$V_{IN} = V_{DD}$	-	100.0	μA
V_{OL}	Output LOW Voltage ^[7]	$I_{OL} = 8\text{ mA} (-1, -2, -3, -4)$ $I_{OL} = 12\text{ mA} (-1H, -5H)$	-	0.4	V
V_{OH}	Output HIGH Voltage ^[7]	$I_{OH} = -8\text{ mA} (-1, -2, -3, -4)$ $I_{OH} = -12\text{ mA} (-1H, -5H)$	2.4	-	V
I_{DD} (PD mode)	Power Down Supply Current	REF = 0 MHz	-	12.0	μA
I_{DD}	Supply Current	Unloaded outputs, 100 MHz REF, Select inputs at V_{DD} or GND	-	45.0	mA
			-	70.0 (-1H, -5H)	mA
		Unloaded outputs, 66 MHz REF (-1, -2, -3, -4)	-	32.0	mA
		Unloaded outputs, 33 MHz REF (-1, -2, -3, -4)	-	18.0	mA

Switching Characteristics for Commercial Temperature Devices

Parameter ^[8]	Name	Test Conditions	Min	Typ.	Max	Unit
t_1	Output Frequency	30 pF load, All devices	10	-	100	MHz
t_1	Output Frequency	20 pF load, -1H, -5H devices ^[9]	10	-	133.3	MHz
t_1	Output Frequency	15 pF load, -1, -2, -3, -4 devices	10	-	133.3	MHz
t_{PD}	Duty Cycle ^[7, 8] = $t_2 \div t_1$ (-1, -2, -3, -4, -1H, -5H)	Measured at 1.4V, $F_{OUT} = 66.66\text{ MHz}$ 30 pF load	40.0	50.0	60.0	%
t_{PD}	Duty Cycle ^[7, 8] = $t_2 \div t_1$ (-1, -2, -3, -4, -1H, -5H)	Measured at 1.4V, $F_{OUT} < 50\text{ MHz}$ 15 pF load	45.0	50.0	55.0	%

Notes

- Applies to both Ref Clock and FBK.
- Parameter is guaranteed by design and characterization. Not 100% tested in production.
- All parameters are specified with loaded outputs.
- CY2308-5H has maximum input frequency of 133.33 MHz and maximum output of 66.67 MHz.

Switching Characteristics for Commercial Temperature Devices (continued)

Parameter ^[8]	Name	Test Conditions	Min	Typ.	Max	Unit
t ₃	Rise Time ^[7, 8] (-1, -2, -3, -4)	Measured between 0.8V and 2.0V, 30 pF load	-	-	2.20	ns
t ₃	Rise Time ^[7, 8] (-1, -2, -3, -4)	Measured between 0.8V and 2.0V, 15 pF load	-	-	1.50	ns
t ₃	Rise Time ^[7, 8] (-1H, -5H)	Measured between 0.8V and 2.0V, 30 pF load	-	-	1.50	ns
t ₄	Fall Time ^[7, 8] (-1, -2, -3, -4)	Measured between 0.8V and 2.0V, 30 pF load	-	-	2.20	ns
t ₄	Fall Time ^[7, 8] (-1, -2, -3, -4)	Measured between 0.8V and 2.0V, 15 pF load	-	-	1.50	ns
t ₄	Fall Time ^[7, 8] (-1H, -5H)	Measured between 0.8V and 2.0V, 30 pF load	-	-	1.25	ns
t ₅	Output to Output Skew on same Bank (-1, -2, -3, -4) ^[7, 8]	All outputs equally loaded	-	-	200	ps
	Output to Output Skew (-1H, -5H)	All outputs equally loaded	-	-	200	ps
	Output Bank A to Output Bank B Skew (-1, -4, -5H)	All outputs equally loaded	-	-	200	ps
	Output Bank A to Output Bank B Skew (-2, -3)	All outputs equally loaded	-	-	400	ps
t ₆	Delay, REF Rising Edge to FBK Rising Edge ^[7, 8]	Measured at V _{DD} /2	-	0	±250	ps
t ₇	Device to Device Skew ^[7, 8]	Measured at V _{DD} /2 on the FBK pins of devices	-	0	700	ps
t ₈	Output Slew Rate ^[7, 8]	Measured between 0.8V and 2.0V on -1H, -5H device using Test Circuit 2	1	-		V/ns
t _J	Cycle to Cycle Jitter ^[7, 8] (-1, -1H, -4, -5H)	Measured at 66.67 MHz, loaded outputs, 15 pF load	-	75	200	ps
		Measured at 66.67 MHz, loaded outputs, 30 pF load	-	-	200	ps
		Measured at 133.3 MHz, loaded outputs, 15 pF load	-	-	100	ps
t _J	Cycle to Cycle Jitter ^[7, 8] (-2, -3)	Measured at 66.67 MHz, loaded outputs 30 pF load	-	-	400	ps
		Measured at 66.67 MHz, loaded outputs 15 pF load	-	-	400	ps
t _{LOCK}	PLL Lock Time ^[7, 8]	Stable power supply, valid clocks presented on REF and FBK pins	-	-	1.0	ms

Operating Conditions for Industrial Temperature Devices

Parameter	Description	Min	Max	Unit
V _{DD}	Supply Voltage	3.0	3.6	V
T _A	Operating Temperature (Ambient Temperature)	-40	85	°C
C _L	Load Capacitance, below 100 MHz	–	30	pF
	Load Capacitance, from 100 MHz to 133 MHz	–	15	pF
C _{IN}	Input Capacitance ^[6]	–	7	pF
t _{PU}	Power up time for all V _{DD} s to reach minimum specified voltage (power ramps must be monotonic)	0.05	50	ms

Electrical Characteristics for Industrial Temperature Devices

Parameter	Description	Test Conditions	Min	Max	Unit
V _{IL}	Input LOW Voltage		–	0.8	V
V _{IH}	Input HIGH Voltage		2.0	–	V
I _{IL}	Input LOW Current	V _{IN} = 0V	–	50.0	μA
I _{IH}	Input HIGH Current	V _{IN} = V _{DD}	–	100.0	μA
V _{OL}	Output LOW Voltage ^[7, 8]	I _{OL} = 8 mA (-1, -2, -3, -4) I _{OL} = 12 mA (-1H, -5H)	–	0.4	V
V _{OH}	Output HIGH Voltage ^[7, 8]	I _{OH} = -8 mA (-1, -2, -3, -4) I _{OH} = -12 mA (-1H, -5H)	2.4	–	V
I _{DD} (PD mode)	Power Down Supply Current	REF = 0 MHz	–	25.0	μA
I _{DD}	Supply Current	Unloaded outputs, 100 MHz, Select inputs at V _{DD} or GND	–	45.0	mA
			–	70(-1H, -5H)	mA
		Unloaded outputs, 66 MHz REF (-1, -2, -3, -4)	–	35.0	mA
		Unloaded outputs, 66 MHz REF (-1, -2, -3, -4)	–	20.0	mA

Switching Characteristics for Industrial Temperature Devices

Parameter ^[8]	Name	Test Conditions	Min	Typ	Max	Unit
t ₁	Output Frequency	30 pF load, All devices	10	–	100	MHz
t ₁	Output Frequency	20 pF load, -1H, -5H devices ^[9]	10	–	133.3	MHz
t ₁	Output Frequency	15 pF load, -1, -2, -3, -4 devices	10	–	133.3	MHz
t _{PD}	Duty Cycle ^[7, 8] = t ₂ ÷ t ₁ (-1, -2, -3, -4, -1H, -5H)	Measured at 1.4V, F _{OUT} = 66.66 MHz 30 pF load	40.0	50.0	60.0	%
t _{PD}	Duty Cycle ^[7, 8] = t ₂ ÷ t ₁ (-1, -2, -3, -4, -1H, -5H)	Measured at 1.4V, F _{OUT} < 50 MHz 15 pF load	45.0	50.0	55.0	%
t ₃	Rise Time ^[7, 8] (-1, -2, -3, -4)	Measured between 0.8V and 2.0V, 30 pF load	–	–	2.50	ns
t ₃	Rise Time ^[7, 8] (-1, -2, -3, -4)	Measured between 0.8V and 2.0V, 15 pF load	–	–	1.50	ns
t ₃	Rise Time ^[7, 8] (-1H, -5H)	Measured between 0.8V and 2.0V, 30 pF load	–	–	1.50	ns
t ₄	Fall Time ^[7, 8] (-1, -2, -3, -4)	Measured between 0.8V and 2.0V, 30 pF load	–	–	2.50	ns
t ₄	Fall Time ^[7, 8] (-1, -2, -3, -4)	Measured between 0.8V and 2.0V, 15 pF load	–	–	1.50	ns

Switching Characteristics for Industrial Temperature Devices (continued)

Parameter ^[8]	Name	Test Conditions	Min	Typ	Max	Unit
t ₄	Fall Time ^[7, 8] (-1H, -5H)	Measured between 0.8V and 2.0V, 30 pF load	-	-	1.25	ns
t ₅	Output to Output Skew on same Bank (-1, -2, -3, -4) ^[7, 8]	All outputs equally loaded	-	-	200	ps
	Output to Output Skew (-1H, -5H)	All outputs equally loaded	-	-	200	ps
	Output Bank A to Output Bank B Skew (-1, -4, -5H)	All outputs equally loaded	-	-	200	ps
	Output Bank A to Output Bank B Skew (-2, -3)	All outputs equally loaded	-	-	400	ps
t ₆	Delay, REF Rising Edge to FBK Rising Edge ^[7, 8]	Measured at V _{DD} /2	-	0	±250	ps
t ₇	Device to Device Skew ^[7, 8]	Measured at V _{DD} /2 on the FBK pins of devices	-	0	700	ps
t ₈	Output Slew Rate ^[7, 8]	Measured between 0.8V and 2.0V on -1H, -5H device using Test Circuit 2	1	-	-	V/ns
t _J	Cycle to Cycle Jitter ^[7, 8] (-1, -1H, -4, -5H)	Measured at 66.67 MHz, loaded outputs, 15 pF load	-	75	200	ps
		Measured at 66.67 MHz, loaded outputs, 30 pF load	-	-	200	ps
		Measured at 133.3 MHz, loaded outputs, 15 pF load	-	-	100	ps
t _J	Cycle to Cycle Jitter ^[7, 8] (-2, -3)	Measured at 66.67 MHz, loaded outputs 30 pF load	-	-	400	ps
		Measured at 66.67 MHz, loaded outputs 15 pF load	-	-	400	ps
t _{LOCK}	PLL Lock Time ^[7, 8]	Stable power supply, valid clocks presented on REF and FBK pins	-	-	1.0	ms

Switching Waveforms

Figure 3. Duty Cycle Timing

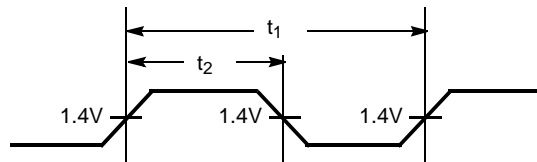
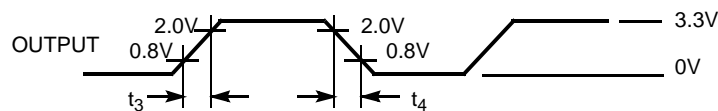

Figure 4. All Outputs Rise/Fall Time



Switching Waveforms (continued)

Figure 5. Output-Output Skew

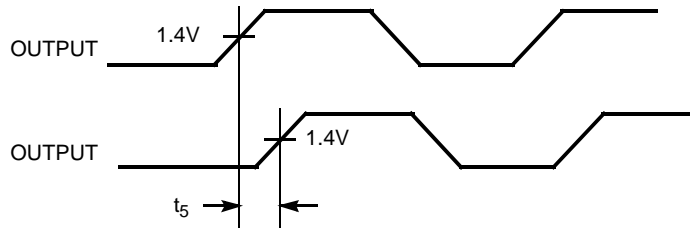

Figure 6. Input-Output Propagation Delay

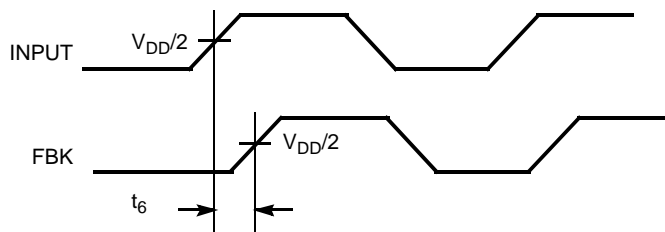
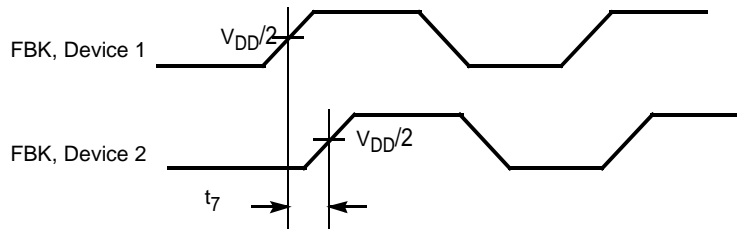
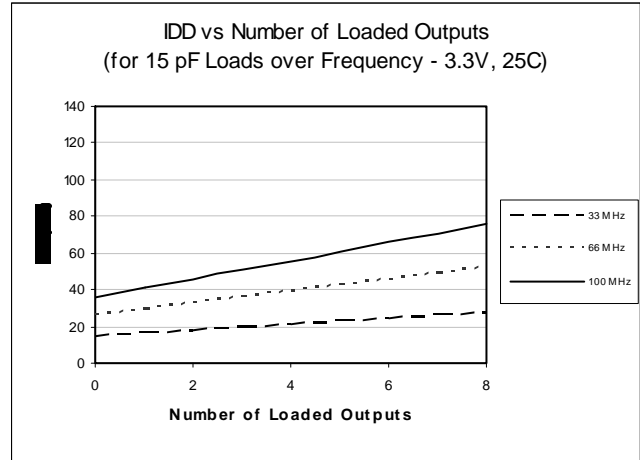
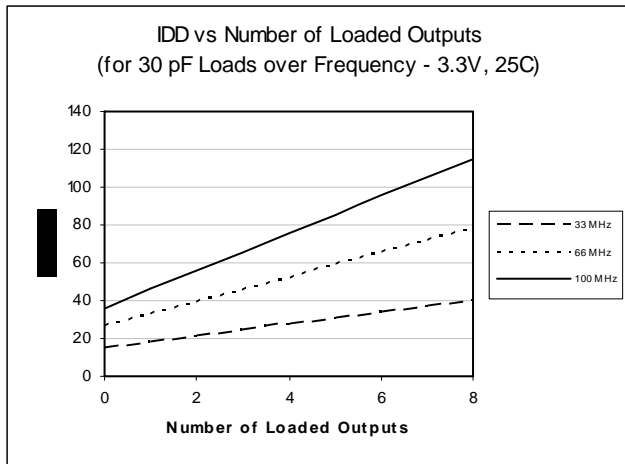
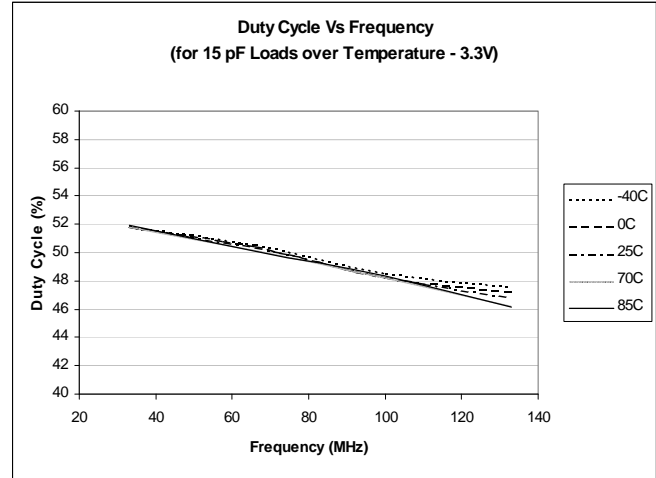
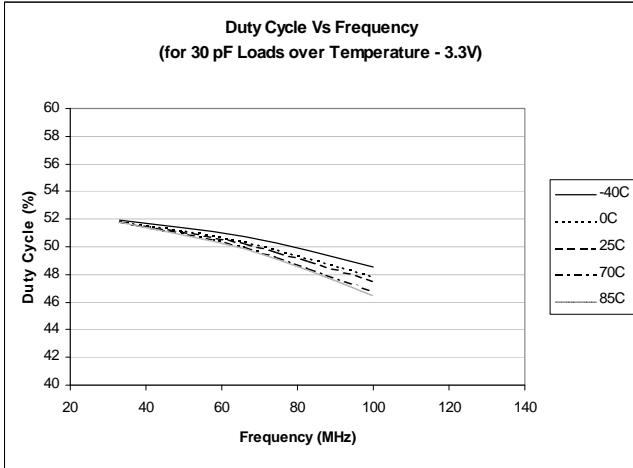
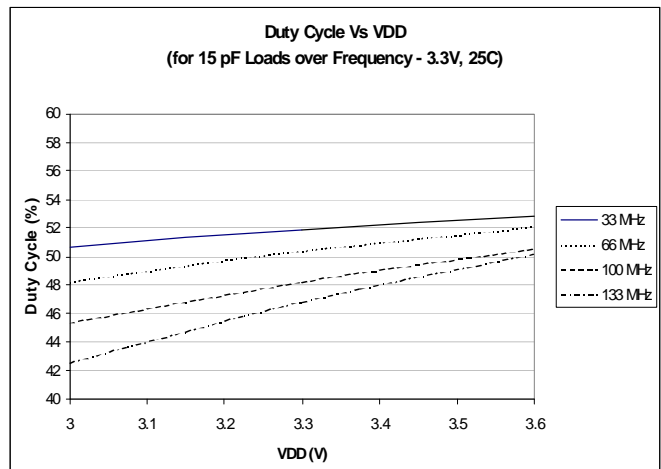
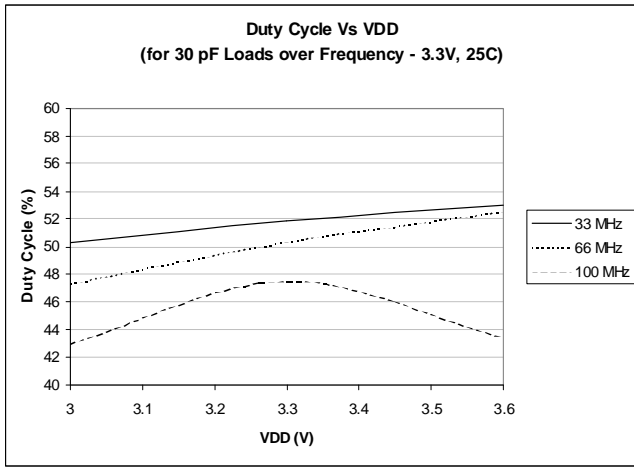

Figure 7. Device-Device Skew



Typical Duty Cycle^[10] and I_{DD} Trends^[11] for CY2308-1,2,3,4



Notes

10. Duty cycle is taken from typical chip measured at 1.4V.

11. I_{DD} data is calculated from I_{DD} = I_{CORE} + nCVf, where I_{CORE} is the unloaded current.
(n = number of outputs; C = Capacitance load per output (F); V = Voltage Supply (V); f = frequency (Hz)).

Typical Duty Cycle^[10] and I_{DD} Trends^[11] for CY2308–1H, 5H

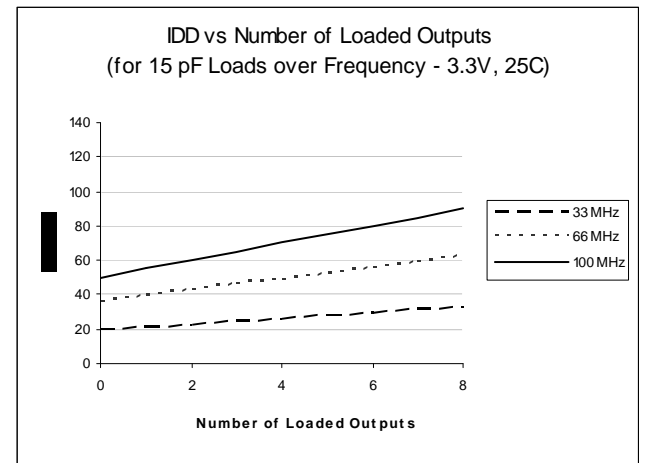
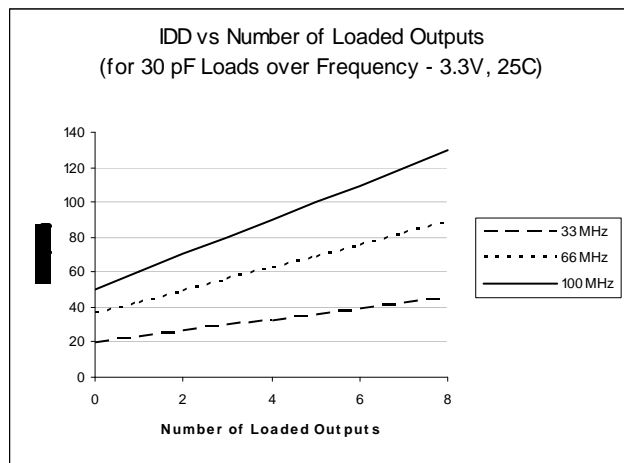
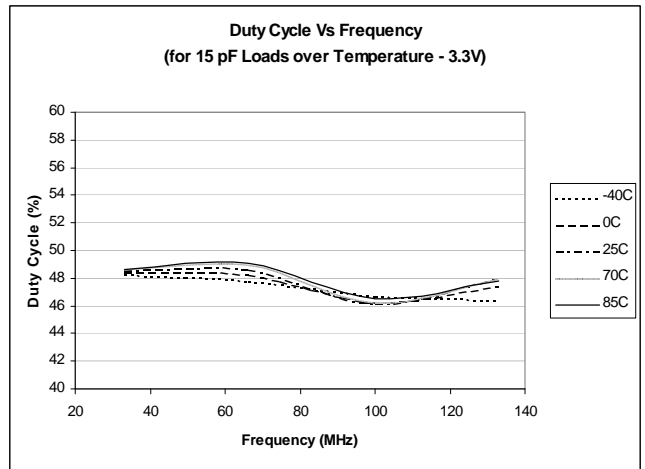
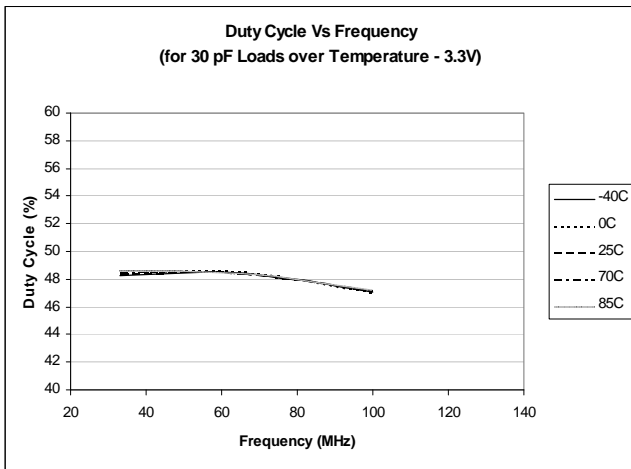
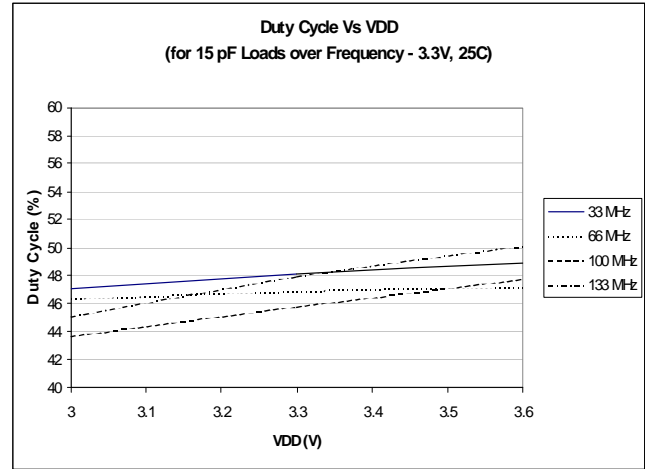
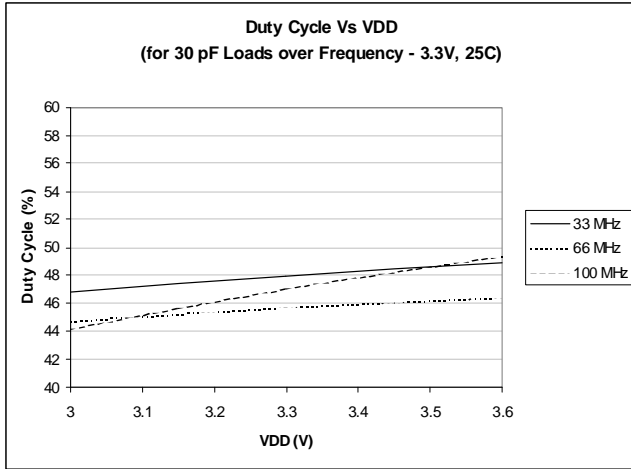

Test Circuits

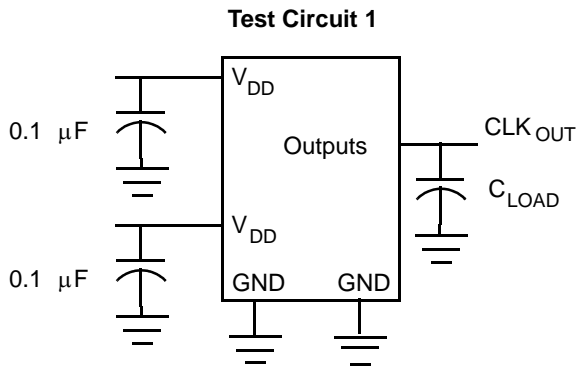

Test Circuit for all parameters except t_g

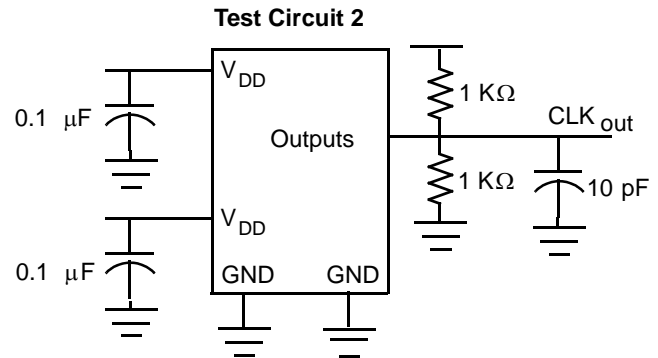

Test Circuit for t_g , Output slew rate on -1H, -5 device

Ordering Information

Ordering Code	Package Type	Operating Range
CY2308SC-1 ^[12]	16-pin 150 mil SOIC	Commercial
CY2308SC-1T ^[12]	16-pin 150 mil SOIC - Tape and Reel	Commercial
CY2308SI-1 ^[12]	16-pin 150 mil SOIC	Industrial
CY2308SI-1T ^[12]	16-pin 150 mil SOIC - Tape and Reel	Industrial
CY2308SC-1H ^[12]	16-pin 150 mil SOIC	Commercial
CY2308SC-1HT ^[12]	16-pin 150 mil SOIC - Tape and Reel	Commercial
CY2308SI-1H ^[12]	16-pin 150 mil SOIC	Industrial
CY2308SI-1HT ^[12]	16-pin 150 mil SOIC - Tape and Reel	Industrial
CY2308ZC-1H ^[12]	16-pin 4.4mm TSSOP	Commercial
CY2308ZC-1HT ^[12]	16-pin 4.4mm TSSOP - Tape and Reel	Commercial
CY2308ZI-1H ^[12]	16-pin 4.4mm TSSOP	Industrial
CY2308ZI-1HT ^[12]	16-pin 4.4mm TSSOP - Tape and Reel	Industrial
CY2308SC-2 ^[12]	16-pin 150 mil SOIC	Commercial
CY2308SC-2T ^[12]	16-pin 150 mil SOIC - Tape and Reel	Commercial
CY2308SI-2 ^[12]	16-pin 150 mil SOIC	Industrial
CY2308SI-2T ^[12]	16-pin 150 mil SOIC - Tape and Reel	Industrial
CY2308SC-3 ^[12]	16-pin 150 mil SOIC	Commercial
CY2308SC-3T ^[12]	16-pin 150 mil SOIC - Tape and Reel	Commercial
CY2308SC-4 ^[12]	16-pin 150 mil SOIC	Commercial
CY2308SC-4T ^[12]	16-pin 150 mil SOIC - Tape and Reel	Commercial

Note

12. Not recommended for new designs.

Ordering Information (continued)

Ordering Code	Package Type	Operating Range
Pb-Free		
CY2308SXC-1	16-pin 150 mil SOIC	Commercial
CY2308SXC-1T	16-pin 150 mil SOIC - Tape and Reel	Commercial
CY2308SXI-1	16-pin 150 mil SOIC	Industrial
CY2308SXI-1T	16-pin 150 mil SOIC - Tape and Reel	Industrial
CY2308SXC-1H	16-pin 150 mil SOIC	Commercial
CY2308SXC-1HT	16-pin 150 mil SOIC - Tape and Reel	Commercial
CY2308SXI-1H	16-pin 150 mil SOIC	Industrial
CY2308SXI-1HT	16-pin 150 mil SOIC - Tape and Reel	Industrial
CY2308ZXC-1H	16-pin 4.4mm TSSOP	Commercial
CY2308ZXC-1HT	16-pin 4.4mm TSSOP - Tape and Reel	Commercial
CY2308ZXI-1H	16-pin 4.4mm TSSOP	Industrial
CY2308ZXI-1HT	16-pin 4.4mm TSSOP - Tape and Reel	Industrial
CY2308SXC-2	16-pin 150 mil SOIC	Commercial
CY2308SXC-2T	16-pin 150 mil SOIC - Tape and Reel	Commercial
CY2308SXI-2	16-pin 150 mil SOIC	Industrial
CY2308SXI-2T	16-pin 150 mil SOIC - Tape and Reel	Industrial
CY2308SXC-3	16-pin 150 mil SOIC	Commercial
CY2308SXC-3T	16-pin 150 mil SOIC - Tape and Reel	Commercial
CY2308SXI-3	16-pin 150 mil SOIC	Industrial
CY2308SXI-3T	16-pin 150 mil SOIC -Tape and Reel	Industrial
CY2308SXC-4	16-pin 150 mil SOIC	Commercial
CY2308SXC-4T	16-pin 150 mil SOIC - Tape and Reel	Commercial
CY2308SXI-4	16-pin 150 mil SOIC	Industrial
CY2308SXI-4T	16-pin 150 mil SOIC - Tape and Reel	Industrial
CY2308SXC-5H ¹	16-pin 150 mil SOIC	Commercial
CY2308SXC-5HT	16-pin 150 mil SOIC - Tape and Reel	Commercial
CY2308SXI-5H	16-pin 150 mil SOIC	Industrial
CY2308SXI-5HT	16-pin 150 mil SOIC - Tape and Reel	Industrial

Package Drawings and Dimensions

Figure 7. 16-Pin (150 Mil) SOIC S16.15

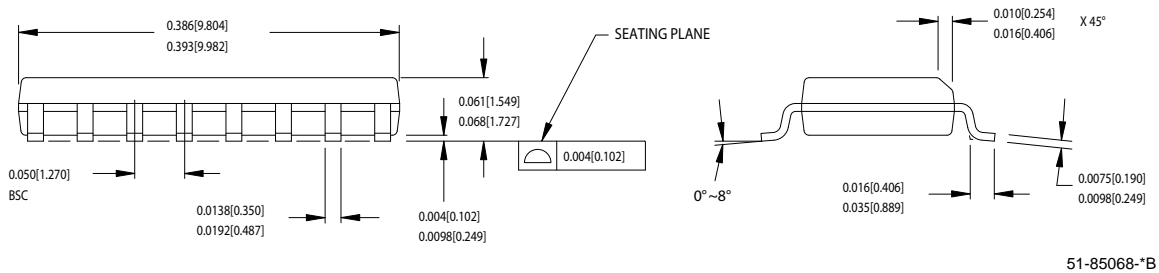
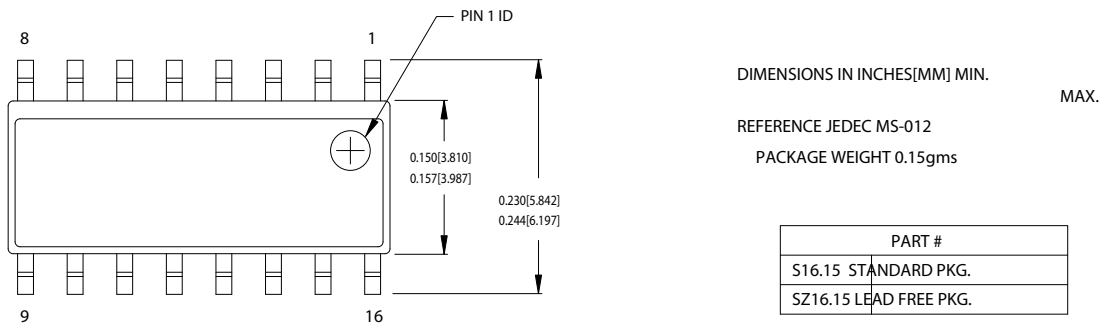
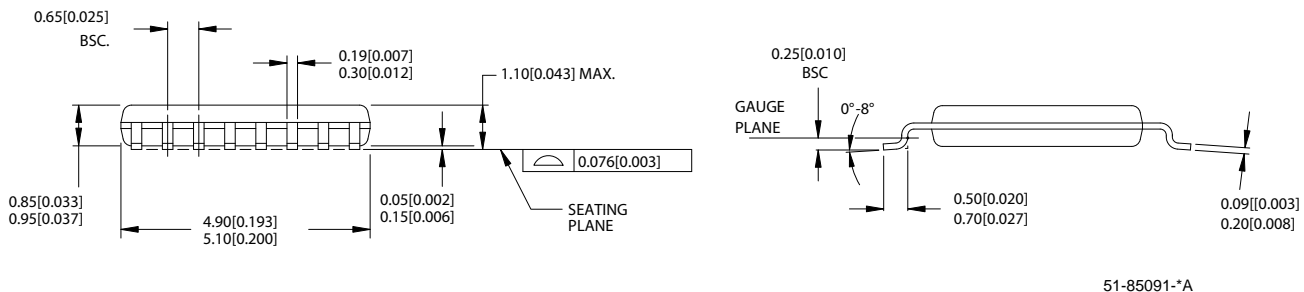
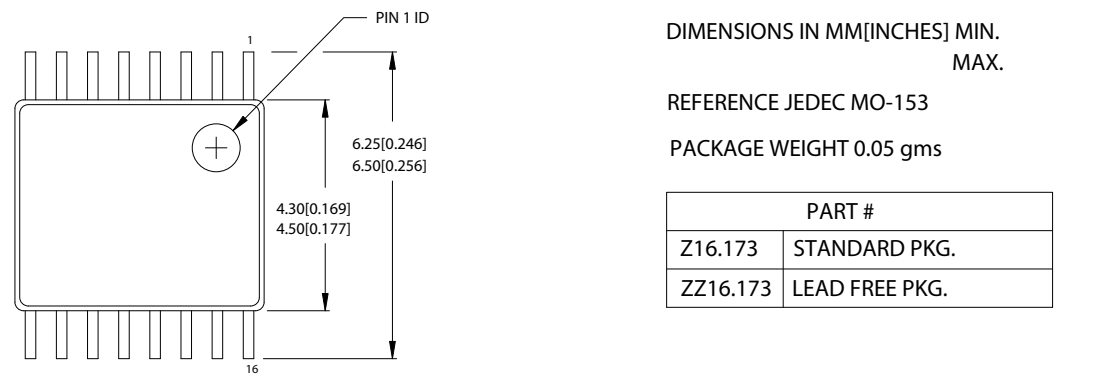

Figure 8. 16-Pin TSSOP 4.40 mm Body Z16.173



Document History Page

Document Title: CY2308 3.3V Zero Delay Buffer Document Number: 38-07146				
Rev.	ECN	Orig. of Change	Submission Date	Description of Change
**	110255	SZV	12/17/01	Changed from Specification number: 38-00528 to 38-07146
*A	118722	RGL	10/31/02	Added Note 1 in page 2.
*B	121832	RBI	12/14/02	Power up requirements added to Operating Conditions Information
*C	235854	RGL	06/24/04	Added Pb-Free Devices
*D	310594	RGL	02/09/05	Removed obsolete parts in the ordering information table Specified typical value for cycle-to-cycle jitter
*E	1344343	KVM/VED	08/20/07	Brought the Ordering Information Table up to date: removed three obsolete parts and added two parts Changed titles to tables that are specific to commercial and industrial temperature ranges
*F	2568575	AESA	09/19/08	Updated template. Added Note "Not recommended for new designs." Changed IDD (PD mode) from 12.0 to 25.0 μ A for Commercial and Industrial Temperature Devices Deleted Duty Cycle parameters for $F_{out} < 50$ MHz Removed CY2308SI-4, CY2308SI-4T and CY2308SC-5HT.
*G	2632364	KVM	01/08/09	Corrected TSSOP package size (from 150 mil to 4.4 mm) in Ordering Information table
*H	2673353	KVM/PYRS	03/13/09	Reverted IDD (PD mode) and Duty Cycle parameters back to the values in revision *E: Changed IDD (PD mode) from 25 to 12 μ A for commercial temperature devices Added Duty Cycle parameters for $F_{out} < 50$ MHz for commercial and industrial devices.

Sales, Solutions, and Legal Information

Worldwide Sales and Design Support

Cypress maintains a worldwide network of offices, solution centers, manufacturer’s representatives, and distributors. To find the office closest to you, visit us at cypress.com/sales.

Products

PSoC	psoc.cypress.com
Clocks & Buffers	clocks.cypress.com
Wireless	wireless.cypress.com
Memories	memory.cypress.com
Image Sensors	image.cypress.com

PSoC Solutions

General	psoc.cypress.com/solutions
Low Power/Low Voltage	psoc.cypress.com/low-power
Precision Analog	psoc.cypress.com/precision-analog
LCD Drive	psoc.cypress.com/lcd-drive
CAN 2.0b	psoc.cypress.com/can
USB	psoc.cypress.com/usb

© Cypress Semiconductor Corporation, 2001-2009. The information contained herein is subject to change without notice. Cypress Semiconductor Corporation assumes no responsibility for the use of any circuitry other than circuitry embodied in a Cypress product. Nor does it convey or imply any license under patent or other rights. Cypress products are not warranted nor intended to be used for medical, life support, life saving, critical control or safety applications, unless pursuant to an express written agreement with Cypress. Furthermore, Cypress does not authorize its products for use as critical components in life-support systems where a malfunction or failure may reasonably be expected to result in significant injury to the user. The inclusion of Cypress products in life-support systems application implies that the manufacturer assumes all risk of such use and in doing so indemnifies Cypress against all charges.

Any Source Code (software and/or firmware) is owned by Cypress Semiconductor Corporation (Cypress) and is protected by and subject to worldwide patent protection (United States and foreign), United States copyright laws and international treaty provisions. Cypress hereby grants to licensee a personal, non-exclusive, non-transferable license to copy, use, modify, create derivative works of, and compile the Cypress Source Code and derivative works for the sole purpose of creating custom software and or firmware in support of licensee product to be used only in conjunction with a Cypress integrated circuit as specified in the applicable agreement. Any reproduction, modification, translation, compilation, or representation of this Source Code except as specified above is prohibited without the express written permission of Cypress.

Disclaimer: CYPRESS MAKES NO WARRANTY OF ANY KIND, EXPRESS OR IMPLIED, WITH REGARD TO THIS MATERIAL, INCLUDING, BUT NOT LIMITED TO, THE IMPLIED WARRANTIES OF MERCHANTABILITY AND FITNESS FOR A PARTICULAR PURPOSE. Cypress reserves the right to make changes without further notice to the materials described herein. Cypress does not assume any liability arising out of the application or use of any product or circuit described herein. Cypress does not authorize its products for use as critical components in life-support systems where a malfunction or failure may reasonably be expected to result in significant injury to the user. The inclusion of Cypress’ product in a life-support systems application implies that the manufacturer assumes all risk of such use and in doing so indemnifies Cypress against all charges.

Use may be limited by and subject to the applicable Cypress software license agreement.