

9956 L

AC axial compact fan



ebm-papst St. Georgen GmbH & Co. KG

Hermann-Papst-Straße 1

78112 St. Georgen

Phone: +49 7724 81-0

Fax: +49 7724 81-1309

www.ebmpapst.com

info2@de.ebmpapst.com

Nominal data

Type	9956 L	
Nominal voltage	[VAC]	230
Frequency	[Hz]	50
Speed	[min ⁻¹]	1850
Power input	[W]	9.5
Min. ambient temperature	[°C]	-40
Max. ambient temperature	[°C]	80
Air flow	[m ³ /h]	84
Sound power level	[B]	4.4
Sound pressure level	[dB(A)]	29

ml = max. load · me = max. efficiency · rfa = running at free air · cs = customer specs · cu = customer unit
Subject to alterations

Technical features

Dimensions	119 x 119 x 25 mm
General description	AC fan with internal rotor shaded-pole motor.
Connection line	2 flat plugs 2.8 x 0.5 mm
Direction of protection	Left, looking at rotor
Direction of air flow	Air exhaust over bars
Bearing	Ball bearings
Lifetime L10 at 40 °C	57500 h
Lifetime L10 at maximum temperature	22500 h
Mass	0.325 kg
Housing material	Metal
Material of impeller	Mineral-reinforced PA plastic
Motor protection	Protected from overload using impedance protection
Approval	VDE, CSA, UL, CE

Product drawing

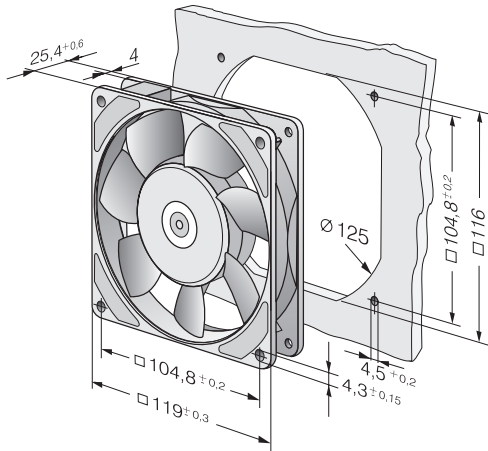

Charts: Air flow

