

3950

AC axial compact fan



ebm-papst St. Georgen GmbH & Co. KG

Hermann-Papst-Straße 1

78112 St. Georgen

Phone: +49 7724 81-0

Fax: +49 7724 81-1309

www.ebmpapst.com

info2@de.ebmpapst.com

Nominal data

Type	3950	
Nominal voltage	[VAC]	230
Frequency	[Hz]	50
Speed	[min ⁻¹]	2650
Power input	[W]	11.0
Min. ambient temperature	[°C]	-20
Max. ambient temperature	[°C]	80
Air flow	[m ³ /h]	59
Sound power level	[B]	4.7
Sound pressure level	[dB(A)]	35

ml = max. load · me = max. efficiency · rfa = running at free air · cs = customer specs · cu = customer unit
Subject to alterations

Technical features

Dimensions	92 x 92 x 25 mm
General description	AC fan with internal rotor shaded-pole motor.
Connection line	2 flat plugs 2.8 x 0.5 mm. Housing with grounding lug for M4 screw.
Direction of protection	Left, looking at rotor
Direction of air flow	Air exhaust over bars
Bearing	Sintec sleeve bearing system
Lifetime L10 at 40 °C	55000 h
Lifetime L10 at maximum temperature	20000 h
Mass	0.280 kg
Housing material	Metal
Material of impeller	Mineral-reinforced PA plastic
Motor protection	Protected from overload using impedance protection
Approval	VDE, CSA, UL, CE

Product drawing

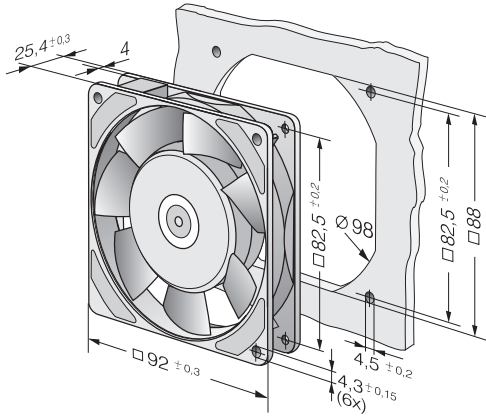

Charts: Air flow

