

NB100LVEP221

2.5V/3.3V 1:20 Differential HSTL/ECL/PECL Clock Driver



ON Semiconductor®

<http://onsemi.com>

Description

The NB100LVEP221 is a low skew 1-to-20 differential clock driver, designed with clock distribution in mind, accepting two clock sources into an input multiplexer. The two clock inputs are differential ECL/PECL; CLK1/ $\overline{\text{CLK1}}$ can also receive HSTL signal levels. The LVPECL input signals can be either differential configuration or single-ended (if the V_{BB} output is used).

The LVEP221 specifically guarantees low output-to-output skew. Optimal design, layout, and processing minimize skew within a device and from device to device.

To ensure tightest skew, both sides of differential outputs should be terminated identically into 50 Ω even if only one output is being used. If an output pair is unused, both outputs may be left open (unterminated) without affecting skew.

The NB100LVEP221, as with most other ECL devices, can be operated from a positive V_{CC} supply in LVPECL mode. This allows the LVEP221 to be used for high performance clock distribution in +3.3 V or +2.5 V systems. In a PECL environment, series or Thevenin line terminations are typically used as they require no additional power supplies. For more information on PECL terminations, designers should refer to Application Note AND8020/D.

The V_{BB} pin, an internally generated voltage supply, is available to this device only. For single-ended LVPECL input conditions, the unused differential input is connected to V_{BB} as a switching reference voltage. V_{BB} may also rebias AC coupled inputs. When used, decouple V_{BB} and V_{CC} via a 0.01 μF capacitor and limit current sourcing or sinking to 0.5 mA. When not used, V_{BB} should be left open.

Single-ended CLK input operation is limited to a $V_{\text{CC}} \geq 3.0$ V in LVPECL mode, or $V_{\text{EE}} \leq -3.0$ V in NECL mode.

Features

- 15 ps Typical Output-to-Output Skew
- 40 ps Typical Device-to- Device Skew
- Jitter Less than 2 ps RMS
- Maximum Frequency > 1.0 GHz Typical
- Thermally Enhanced 52-Lead LQFP and QFN
- V_{BB} Output
- 540 ps Typical Propagation Delay
- LVPECL and HSTL Mode Operating Range:
 $V_{\text{CC}} = 2.375$ V to 3.8 V with $V_{\text{EE}} = 0$ V
- NECL Mode Operating Range:
 $V_{\text{CC}} = 0$ V with $V_{\text{EE}} = -2.375$ V to -3.8 V
- Q Output will Default Low with Inputs Open or at V_{EE}
- Pin Compatible with Motorola MC100EP221
- Pb-Free Packages are Available*

*For additional information on our Pb-Free strategy and soldering details, please download the ON Semiconductor Soldering and Mounting Techniques Reference Manual, SOLDERRM/D.

MARKING DIAGRAM*

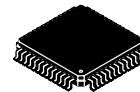

LQFP-52
FA SUFFIX
CASE 848H

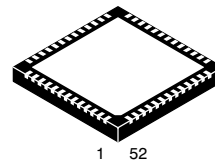
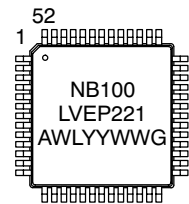

QFN-52
MN SUFFIX
CASE 485M

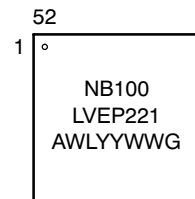

| | |
|----|---------------------|
| A | = Assembly Location |
| WL | = Wafer Lot |
| YY | = Year |
| WW | = Work Week |
| G | = Pb-Free Package |

*For additional marking information, refer to Application Note AND8002/D.

ORDERING INFORMATION

See detailed ordering and shipping information in the package dimensions section on page 10 of this data sheet.

NB100LVEP221

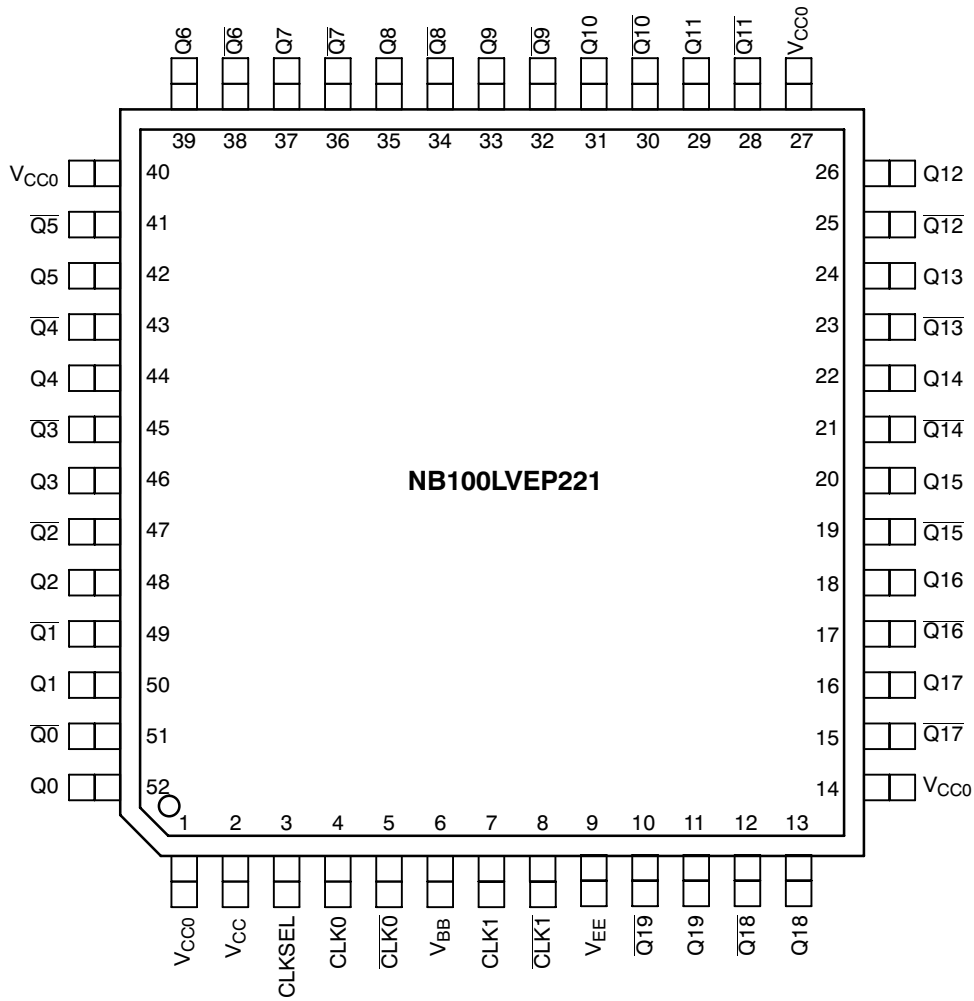

All V_{CC} , V_{CC0} , and V_{EE} pins must be externally connected to appropriate Power Supply to guarantee proper operation. The thermally conductive exposed pad on package bottom (see package case drawing) must be attached to a heat-sinking conduit, capable of transferring 1.2 Watts. This exposed pad is electrically connected to V_{EE} internally.

Figure 1. 52-Lead LQFP Pinout (Top View)

NB100LVEP221

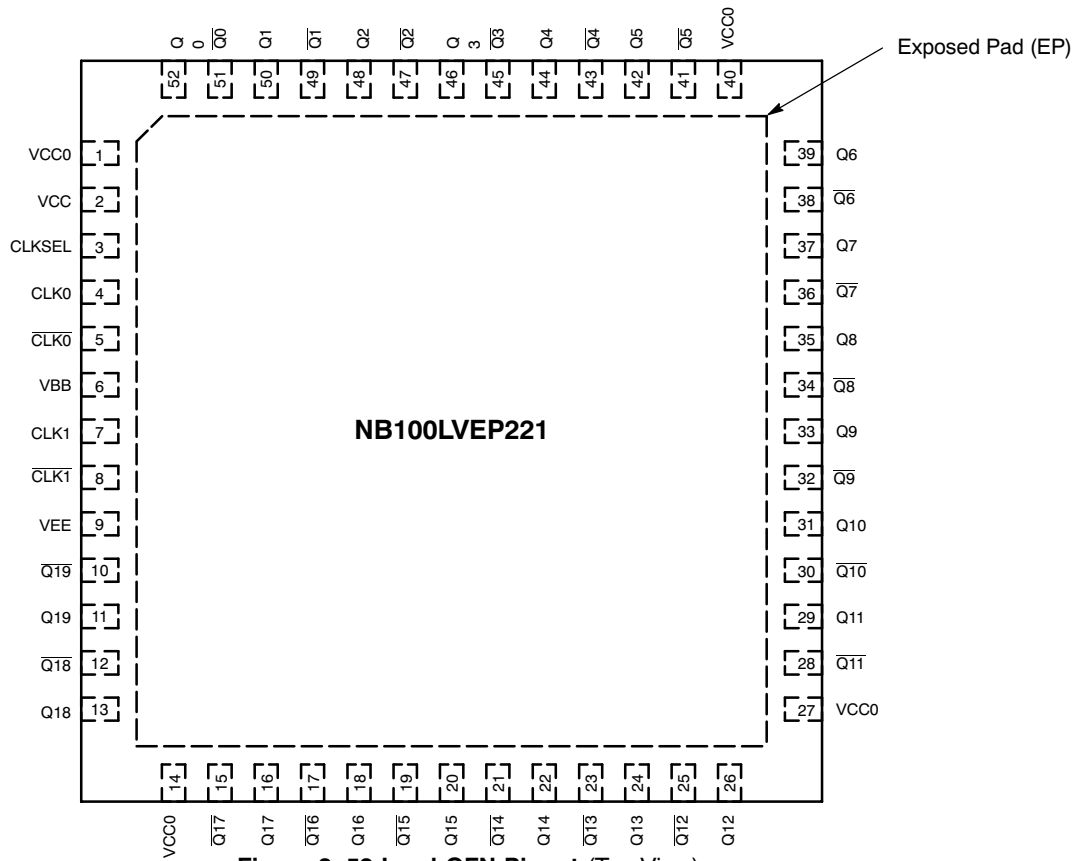

Figure 2. 52-Lead QFN Pinout (Top View)

Table 1. PIN DESCRIPTION

| PIN | FUNCTION |
|---|--------------------------------------|
| CLK0*, $\overline{\text{CLK0}}$ ** | ECL/PECL Differential Inputs |
| CLK1*, $\overline{\text{CLK1}}$ ** | ECL/PECL or HSTL Differential Inputs |
| Q0:19, $\overline{\text{Q0}}$: $\overline{\text{Q19}}$ | ECL/PECL Differential Outputs |
| CLK_SEL* | ECL/PECL Active Clock Select Input |
| V _{BB} | Reference Voltage Output |
| V _{CC} /V _{CC0} | Positive Supply |
| V _{EE} ** | Negative Supply |

* Pins will default LOW when left open.

** Pins will default HIGH when left open.

*** The thermally conductive exposed pad on the bottom of the package is electrically connected to V_{EE} internally.

Table 2. FUNCTION TABLE

| CLK_SEL | Active Input |
|---------|--------------------------------|
| L | CLK0, $\overline{\text{CLK0}}$ |
| H | CLK1, $\overline{\text{CLK1}}$ |

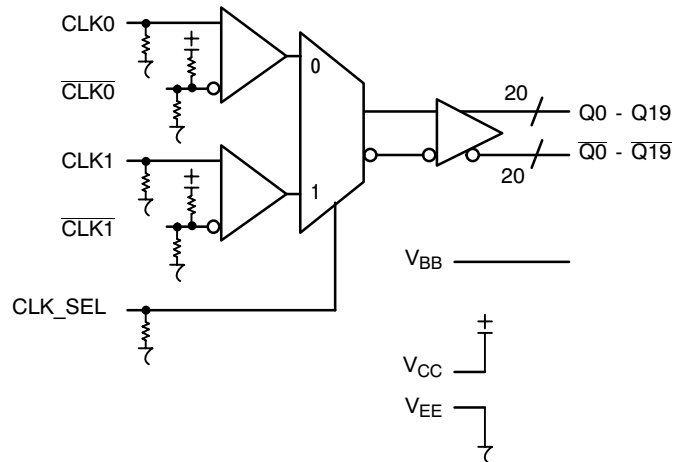

Figure 3. Logic Diagram

NB100LVEP221

Table 3. ATTRIBUTES

| Characteristics | Value | |
|---|---|------------------------------------|
| Internal Input Pulldown Resistor | 75 kΩ | |
| Internal Input Pullup Resistor | 37.5 kΩ | |
| ESD Protection | Human Body Model Machine Model Charged Device Model | > 2 kV > 200 V > 2 kV |
| Moisture Sensitivity, Indefinite Time Out of Drypack (Note 1) | Pb Pkg | Pb-Free Pkg |
| | LQFP-52 QFN-52 | Level 2 - Level 3 Level 2 |
| Flammability Rating | Oxygen Index: 28 to 34 | UL 94 V-0 @ 0.125 in |
| Transistor Count | 533 Devices | |
| Meets or exceeds JEDEC Spec EIA/JESD78 IC Latchup Test | | |

1. For additional information, refer to Application Note AND8003/D.

Table 4. MAXIMUM RATINGS

| Symbol | Parameter | Condition 1 | Condition 2 | Rating | Unit |
|------------------|---|--|--|-------------|--------------|
| V _{CC} | PECL Mode Power Supply | V _{EE} = 0 V | | 6 | V |
| V _{EE} | NECL Mode Power Supply | V _{CC} = 0 V | | -6 | V |
| V _I | PECL Mode Input Voltage NECL Mode Input Voltage | V _{EE} = 0 V V _{CC} = 0 V | V _I ≤ V _{CC} V _I ≥ V _{EE} | 6 -6 | V V |
| I _{out} | Output Current | Continuous Surge | | 50 100 | mA mA |
| I _{BB} | V _{BB} Sink/Source | | | ± 0.5 | mA |
| T _A | Operating Temperature Range | | | -40 to +85 | °C |
| T _{stg} | Storage Temperature Range | | | -65 to +150 | °C |
| θ _{JA} | Thermal Resistance (Junction-to-Ambient) (See Application Information) | 0 lfpm 500 lfpm | LQFP-52 LQFP-52 | 35.6 30 | °C/W °C/W |
| θ _{JC} | Thermal Resistance (Junction-to-Case) (See Application Information) | 0 lfpm 500 lfpm | LQFP-52 LQFP-52 | 3.2 6.4 | °C/W °C/W |
| θ _{JA} | Thermal Resistance (Junction-to-Ambient) (Note) | 0 lfpm 500 lfpm | QFN-52 QFN-52 | 25 19.6 | °C/W °C/W |
| θ _{JC} | Thermal Resistance (Junction-to-Case) (Note) | 2S2P | QFN-52 | 21 | °C/W |
| T _{sol} | Wave Solder | Pb Pb-Free | | 265 265 | °C |

Stresses exceeding Maximum Ratings may damage the device. Maximum Ratings are stress ratings only. Functional operation above the Recommended Operating Conditions is not implied. Extended exposure to stresses above the Recommended Operating Conditions may affect device reliability.

NB100LVEP221

Table 5. LVPECL DC CHARACTERISTICS $V_{CC} = 2.5\text{ V}$; $V_{EE} = 0\text{ V}$ (Note 2)

| Symbol | Characteristic | -40 °C | | | 25 °C | | | 85 °C | | | Unit |
|-------------|--|--------|------|------|-------|------|------|-------|------|------|---------------|
| | | Min | Typ | Max | Min | Typ | Max | Min | Typ | Max | |
| I_{EE} | Power Supply Current | 100 | 125 | 150 | 104 | 130 | 156 | 116 | 145 | 174 | mA |
| V_{OH} | Output HIGH Voltage (Note 3) | 1355 | 1480 | 1605 | 1355 | 1480 | 1605 | 1355 | 1480 | 1605 | mV |
| V_{OL} | Output LOW Voltage (Note 3) | 555 | 680 | 900 | 555 | 680 | 900 | 555 | 680 | 900 | mV |
| V_{IH} | Input HIGH Voltage (Single-Ended) (Note 4) | 1335 | | 1620 | 1335 | | 1620 | 1275 | | 1620 | mV |
| V_{IL} | Input LOW Voltage (Single-Ended) (Note 4) | 555 | | 900 | 555 | | 900 | 555 | | 900 | mV |
| V_{IHCMR} | Input HIGH Voltage Common Mode Range (Differential Configuration) (Note 5) | | | | | | | | | | |
| | CLK0/CLK0 | 1.2 | | 2.5 | 1.2 | | 2.5 | 1.2 | | 2.5 | V |
| | CLK1/CLK1 | 0.3 | | 1.6 | 0.3 | | 1.6 | 0.3 | | 1.6 | V |
| I_{IH} | Input HIGH Current | | | 150 | | | 150 | | | 150 | μA |
| I_{IL} | Input LOW Current | | | | | | | | | | μA |
| | CLK | 0.5 | | | 0.5 | | | 0.5 | | | μA |
| | CLK | -150 | | | -150 | | | -150 | | | μA |

NOTE: Device will meet the specifications after thermal equilibrium has been established when mounted in a test socket or printed circuit board with maintained transverse airflow greater than 500 lfm. Electrical parameters are guaranteed only over the declared operating temperature range. Functional operation of the device exceeding these conditions is not implied. Device specification limit values are applied individually under normal operating conditions and not valid simultaneously.

- Input and output parameters vary 1:1 with V_{CC} . V_{EE} can vary + 0.125 V to -1.3 V.
- All outputs loaded with 50 Ω to $V_{CC} - 2.0\text{ V}$.
- Do not use V_{BB} at $V_{CC} < 3.0\text{ V}$.
- V_{IHCMR} min varies 1:1 with V_{EE} , V_{IHCMR} max varies 1:1 with V_{CC} . The V_{IHCMR} range is referenced to the most positive side of the differential input signal.

Table 6. LVPECL DC CHARACTERISTICS $V_{CC} = 3.3\text{ V}$; $V_{EE} = 0\text{ V}$ (Note 6)

| Symbol | Characteristic | -40 °C | | | 25 °C | | | 85 °C | | | Unit |
|-------------|--|--------|------|------|-------|------|------|-------|------|------|---------------|
| | | Min | Typ | Max | Min | Typ | Max | Min | Typ | Max | |
| I_{EE} | Power Supply Current | 100 | 125 | 150 | 104 | 130 | 156 | 116 | 145 | 174 | mA |
| V_{OH} | Output HIGH Voltage (Note 7) | 2155 | 2280 | 2405 | 2155 | 2280 | 2405 | 2155 | 2280 | 2405 | mV |
| V_{OL} | Output LOW Voltage (Note 7) | 1355 | 1480 | 1700 | 1355 | 1480 | 1700 | 1355 | 1480 | 1700 | mV |
| V_{IH} | Input HIGH Voltage (Single-Ended) | 2135 | | 2420 | 2135 | | 2420 | 2135 | | 2420 | mV |
| V_{IL} | Input LOW Voltage (Single-Ended) | 1355 | | 1700 | 1355 | | 1700 | 1355 | | 1700 | mV |
| V_{BB} | Output Reference Voltage (Note 8) | 1775 | 1875 | 1975 | 1775 | 1875 | 1975 | 1775 | 1875 | 1975 | mV |
| V_{IHCMR} | Input HIGH Voltage Common Mode Range (Differential Configuration) (Note 9) | | | | | | | | | | |
| | CLK0/CLK0 | 1.2 | | 3.3 | 1.2 | | 3.3 | 1.2 | | 3.3 | V |
| | CLK1/CLK1 | 0.3 | | 1.6 | 0.3 | | 1.6 | 0.3 | | 1.6 | V |
| I_{IH} | Input HIGH Current | | | 150 | | | 150 | | | 150 | μA |
| I_{IL} | Input LOW Current | | | | | | | | | | μA |
| | CLK | 0.5 | | | 0.5 | | | 0.5 | | | μA |
| | CLK | -150 | | | -150 | | | -150 | | | μA |

NOTE: Device will meet the specifications after thermal equilibrium has been established when mounted in a test socket or printed circuit board with maintained transverse airflow greater than 500 lfm. Electrical parameters are guaranteed only over the declared operating temperature range. Functional operation of the device exceeding these conditions is not implied. Device specification limit values are applied individually under normal operating conditions and not valid simultaneously.

- Input and output parameters vary 1:1 with V_{CC} . V_{EE} can vary + 0.925 V to -0.5 V.
- All outputs loaded with 50 Ω to $V_{CC} - 2.0\text{ V}$.
- Single-ended input operation is limited $V_{CC} \geq 3.0\text{ V}$ in LVPECL mode.
- V_{IHCMR} min varies 1:1 with V_{EE} , V_{IHCMR} max varies 1:1 with V_{CC} . The V_{IHCMR} range is referenced to the most positive side of the differential input signal.

NB100LVEP221

Table 7. LVNECL DC CHARACTERISTICS $V_{CC} = 0\text{ V}$, $V_{EE} = -2.375\text{ V}$ to -3.8 V (Note 10)

| Symbol | Characteristic | -40 °C | | | 25 °C | | | 85 °C | | | Unit | |
|-------------|---|-------------|-------|----------------------------------|-------------|-------|----------------------------------|-------------|-------|----------------------------------|-------------|--------|
| | | Min | Typ | Max | Min | Typ | Max | Min | Typ | Max | | |
| I_{EE} | Power Supply Current | 100 | 125 | 150 | 104 | 130 | 156 | 116 | 145 | 174 | mA | |
| V_{OH} | Output HIGH Voltage (Note 11) | -1 145 | -1020 | -895 | -1 145 | -1020 | -895 | -1 145 | -1020 | -895 | mV | |
| V_{OL} | Output LOW Voltage (Note 11) | -1945 | -1820 | -1600 | -1945 | -1820 | -1600 | -1945 | -1820 | -1600 | mV | |
| V_{IH} | Input HIGH Voltage (Single-Ended) | -1 165 | | -880 | -1 165 | | -880 | -1 165 | | -880 | mV | |
| V_{IL} | Input LOW Voltage (Single-Ended) | -1945 | | -1600 | -1945 | | -1600 | -1945 | | -1600 | mV | |
| V_{BB} | Output Reference Voltage (Note 12) | -1525 | -1425 | -1325 | -1525 | -1425 | -1325 | -1525 | -1425 | -1325 | mV | |
| V_{IHCMR} | Input HIGH Voltage Common Mode Range (Differential Configuration) (Note 13) CLK0/CLK0 CLK1/CLK1 | | | | | | | | | | V V | |
| | | | | $V_{EE} + 1.2$ $V_{EE} + 0.3$ | 0.0 -0.9 | | $V_{EE} + 1.2$ $V_{EE} + 0.3$ | 0.0 -0.9 | | $V_{EE} + 1.2$ $V_{EE} + 0.3$ | 0.0 -0.9 | V V |
| I_{IH} | Input HIGH Current | | | 150 | | | 150 | | | 150 | μ A | |
| I_{IL} | Input LOW Current CLK CLK | 0.5 -150 | | | 0.5 -150 | | | 0.5 -150 | | | μ A | |

NOTE: Device will meet the specifications after thermal equilibrium has been established when mounted in a test socket or printed circuit board with maintained transverse airflow greater than 500 lpm. Electrical parameters are guaranteed only over the declared operating temperature range. Functional operation of the device exceeding these conditions is not implied. Device specification limit values are applied individually under normal operating conditions and not valid simultaneously.

10. Input and output parameters vary 1:1 with V_{CC} .

11. All outputs loaded with $50\ \Omega$ to $V_{CC}-2.0\text{ V}$.

12. Single-ended input operation is limited $V_{EE} \leq -3.0\text{ V}$ in NECL mode.

13. V_{IHCMR} min varies 1:1 with V_{EE} . V_{IHCMR} max varies 1:1 with V_{CC} . The V_{IHCMR} range is referenced to the most positive side of the differential input signal.

Table 8. HSTL DC CHARACTERISTICS $V_{CC} = 3.3\text{ V}$; $V_{EE} = 0\text{ V}$

| Symbol | Characteristic | 0 °C | | | 25 °C | | | 85 °C | | | Unit |
|----------|--|--------------|-----|-----------|--------------|-----|-----------|--------------|-----|-----------|---------|
| | | Min | Typ | Max | Min | Typ | Max | Min | Typ | Max | |
| V_{IH} | Input HIGH Voltage CLK1/CLK1 | V_x+100 | | 1600 | V_x+100 | | 1600 | V_x+100 | | 1600 | mV |
| V_{IL} | Input LOW Voltage CLK1/CLK1 | -300 | | V_x-100 | -300 | | V_x-100 | -300 | | V_x-100 | mV |
| V_X | Differential Configuration Cross Point Voltage | 680 | | 900 | 680 | | 900 | 680 | | 900 | mV |
| I_{IH} | Input HIGH Current | -150 | | 150 | -150 | | 150 | -150 | | 150 | μ A |
| I_{IL} | Input LOW Current CLK1 CLK1 | -150 -250 | | | -150 -250 | | | -150 -250 | | | μ A |

NOTE: Device will meet the specifications after thermal equilibrium has been established when mounted in a test socket or printed circuit board with maintained transverse airflow greater than 500 lpm. Electrical parameters are guaranteed only over the declared operating temperature range. Functional operation of the device exceeding these conditions is not implied. Device specification limit values are applied individually under normal operating conditions and not valid simultaneously.

NB100LVEP221

Table 9. AC CHARACTERISTICS $V_{CC} = 0\text{ V}$; $V_{EE} = -2.375\text{ to }-3.8\text{ V}$ or $V_{CC} = 2.375\text{ to }3.8\text{ V}$; $V_{EE} = 0\text{ V}$ (Note 14)

| Symbol | Characteristic | -40 °C | | | 25 °C | | | 85 °C | | | Unit | |
|-------------------|--|----------------------------|-----|------|-------|-----|------|-------|-----|------|------|----|
| | | Min | Typ | Max | Min | Typ | Max | Min | Typ | Max | | |
| V_{Opp} | Differential Output Voltage (Figure 4) | $f_{out} < 50\text{ MHz}$ | 550 | 700 | | 600 | 700 | | 600 | 700 | | mV |
| | | $f_{out} < 0.8\text{ GHz}$ | 550 | 700 | | 550 | 700 | | 500 | 700 | | mV |
| | | $f_{out} < 1.0\text{ GHz}$ | 500 | 700 | | 500 | 700 | | 400 | 600 | | mV |
| t_{PLH}/t_{PHL} | Propagation Delay (Differential Configuration) CLK0-Qx CLK1-Qx | | 540 | 600 | | 540 | 660 | | 540 | 750 | | ps |
| | | | 590 | 640 | | 590 | 710 | | 590 | 800 | | ps |
| t_{skew} | Within-Device Skew (Note 15) | | 15 | 50 | | 15 | 50 | | 15 | 50 | | ps |
| | Device-to-Device Skew (Note 16) | | 40 | 200 | | 40 | 200 | | 40 | 200 | | ps |
| t_{JITTER} | Random Clock Jitter (RMS) (Figure 4) | | 1 | 2 | | 1 | 2 | | 1 | 2 | | ps |
| V_{PP} | Input Swing (Differential Configuration) (Note 17) (Figure 5) | CLK0 | 400 | 800 | 1200 | 400 | 800 | 1200 | 400 | 800 | 1200 | mV |
| | | CLK1 HSTL | 300 | 800 | 1000 | 300 | 800 | 1000 | 300 | 800 | 1000 | mV |
| DCO | Output Duty Cycle | 49.5 | 50 | 50.5 | 49.5 | 50 | 50.5 | 49.5 | 50 | 50.5 | | % |
| t_r/t_f | Output Rise/Fall Time (20%-80%) | 100 | 200 | 300 | 100 | 200 | 300 | 150 | 250 | 350 | | ps |

NOTE: Device will meet the specifications after thermal equilibrium has been established when mounted in a test socket or printed circuit board with maintained transverse airflow greater than 500 lfpm. Electrical parameters are guaranteed only over the declared operating temperature range. Functional operation of the device exceeding these conditions is not implied. Device specification limit values are applied individually under normal operating conditions and not valid simultaneously.

14. Measured with 750 mV source (LVPECL) or 1 V (HSTL) source, 50% duty cycle clock source. All outputs loaded with 50 Ω to $V_{CC}-2\text{ V}$.

15. Skew is measured between outputs under identical transitions and conditions on any one device.

16. Device-to-Device skew for identical transitions, outputs and V_{CC} levels.

17. V_{PP} is the differential configuration input voltage swing required to maintain AC characteristics.

NB100LVEP221

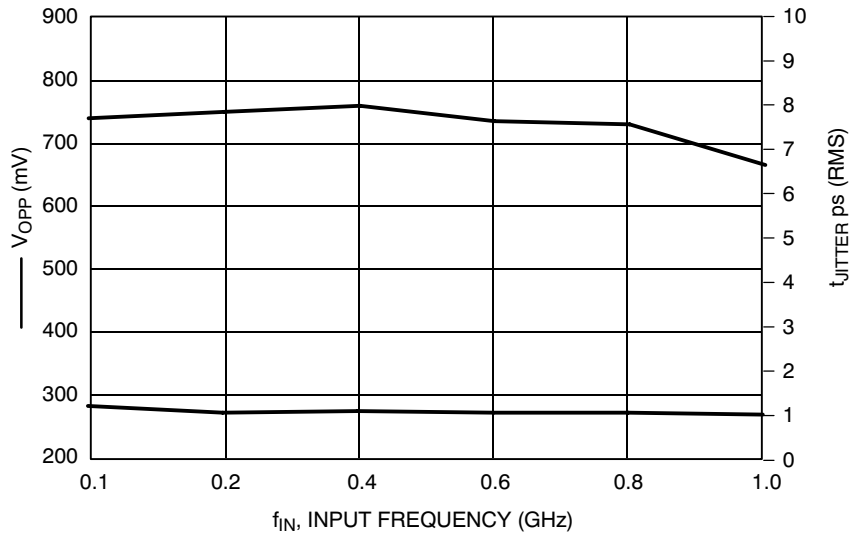

Figure 4. Output Voltage (V_{OPP})/Jitter versus Input Frequency ($V_{CC} - V_{EE} = 3.3 \text{ V} @ 25^\circ\text{C}$)

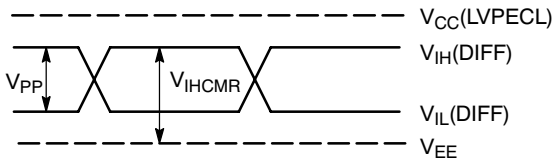

Figure 5. LVPECL Differential Input Levels

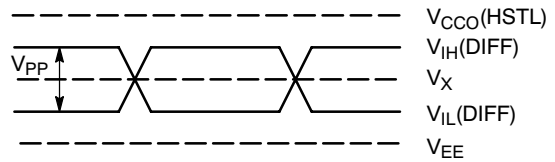

Figure 6. HSTL Differential Input Levels

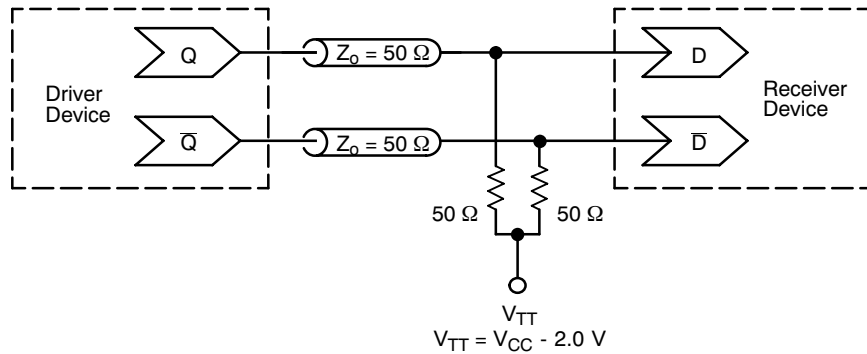

Figure 7. Typical Termination for Output Driver and Device Evaluation (See Application Note AND8020/D - Termination of ECL Logic Devices.)

APPLICATIONS INFORMATION

Using the thermally enhanced package of the NB100LVEP221

The NB100LVEP221 uses a thermally enhanced 52-lead LQFP package. The package is molded so that a portion of the leadframe is exposed at the surface of the package bottom side. This exposed metal pad will provide the low thermal impedance that supports the power consumption of the NB100LVEP221 high-speed bipolar integrated circuit and will ease the power management task for the system design. In multilayer board designs, a thermal land pattern on the printed circuit board and thermal vias are recommended to maximize both the removal of heat from the package and electrical performance of the NB100LVEP221. The size of the land pattern can be larger, smaller, or even take on a different shape than the exposed pad on the package. However, the solderable area should be at least the same size and shape as the exposed pad on the package. Direct soldering of the exposed pad to the thermal land will provide an efficient thermal conduit. The thermal vias will connect the exposed pad of the package to internal copper planes of the board. The number of vias, spacing, via diameters and land pattern design depend on the application and the amount of heat to be removed from the package.

Maximum thermal and electrical performance is achieved when an array of vias is incorporated in the land pattern.

The recommended thermal land design for NB100LVEP221 applications on multi-layer boards comprises a 4 X 4 thermal via array using a 1.2 mm pitch as shown in Figure 8 providing an efficient heat removal path.

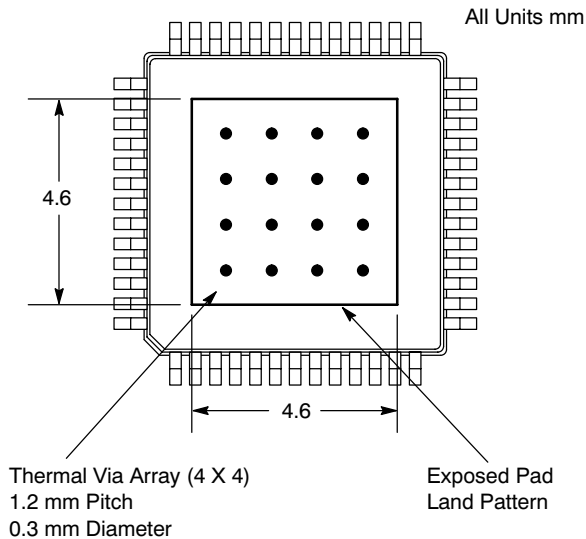

Figure 8. Recommended Thermal Land Pattern

The via diameter should be approximately 0.3 mm with 1 oz. copper via barrel plating. Solder wicking inside the via may result in voiding during the solder process and must be avoided. If the copper plating does not plug the vias, stencil print solder paste onto the printed circuit pad. This will

supply enough solder paste to fill those vias and not starve the solder joints. The attachment process for the exposed pad package is equivalent to standard surface mount packages. Figure 9, “Recommended solder mask openings”, shows a recommended solder mask opening with respect to a 4 X 4 thermal via array. Because a large solder mask opening may result in a poor rework release, the opening should be subdivided as shown in Figure 9. For the nominal package standoff of 0.1 mm, a stencil thickness of 5 to 8 mils should be considered.

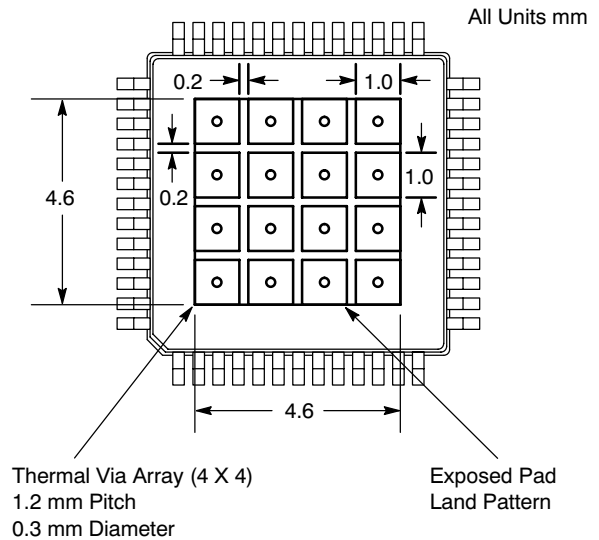

Figure 9. Recommended Solder Mask Openings

Proper thermal management is critical for reliable system operation. This is especially true for high-fanout and high output drive capability products.

For thermal system analysis and junction temperature calculation, the thermal resistance parameters of the package are provided:

Table 10. Thermal Resistance *

| Ifpm | θ_{JA} °C/W | θ_{JC} °C/W |
|------|--------------------|--------------------|
| 0 | 35.6 | 3.2 |
| 100 | 32.8 | 4.9 |
| 500 | 30.0 | 6.4 |

* Junction to ambient and Junction to board, four-conductor layer test board (2S2P) per JESD 51-8

These recommendations are to be used as a guideline, only. It is therefore recommended that users employ sufficient thermal modeling analysis to assist in applying the general recommendations to their particular application to assure adequate thermal performance. The exposed pad of the NB100LVEP221 package is electrically shorted to the substrate of the integrated circuit and V_{EE} . The thermal land should be electrically connected to V_{EE} .

NB100LVEP221

ORDERING INFORMATION

| Device | Package | Shipping† |
|-------------------|----------------------|--------------------|
| NB100LVEP221FA | LQFP-52 | 160 Units / Tray |
| NB100LVEP221FAG | LQFP-52 (Pb-Free) | 160 Units / Tray |
| NB100LVEP221FAR2 | LQFP-52 | 1500 / Tape & Reel |
| NB100LVEP221FARG | LQFP-52 (Pb-Free) | 1500 / Tape & Reel |
| NB100LVEP221MNG | QFN-52 (Pb-Free) | 260 Units / Tray |
| NB100LVEP221MNR2G | QFN-52 (Pb-Free) | 2000 / Tape & Reel |

†For information on tape and reel specifications, including part orientation and tape sizes, please refer to our Tape and Reel Packaging Specifications Brochure, BRD8011/D.

Resource Reference of Application Notes

- AN1405/D** - ECL Clock Distribution Techniques
- AN1406/D** - Designing with PECL (ECL at +5.0 V)
- AN1503/D** - ECLinPS™ I/O SPICE Modeling Kit
- AN1504/D** - Metastability and the ECLinPS Family
- AN1568/D** - Interfacing Between LVDS and ECL
- AN1672/D** - The ECL Translator Guide
- AND8001/D** - Odd Number Counters Design
- AND8002/D** - Marking and Date Codes
- AND8020/D** - Termination of ECL Logic Devices
- AND8066/D** - Interfacing with ECLinPS
- AND8090/D** - AC Characteristics of ECL Devices

NB100LVEP221

PACKAGE DIMENSIONS

LQFP 52 LEAD EXPOSED PAD PACKAGE CASE 848H-01 ISSUE A

SCALE 1:1

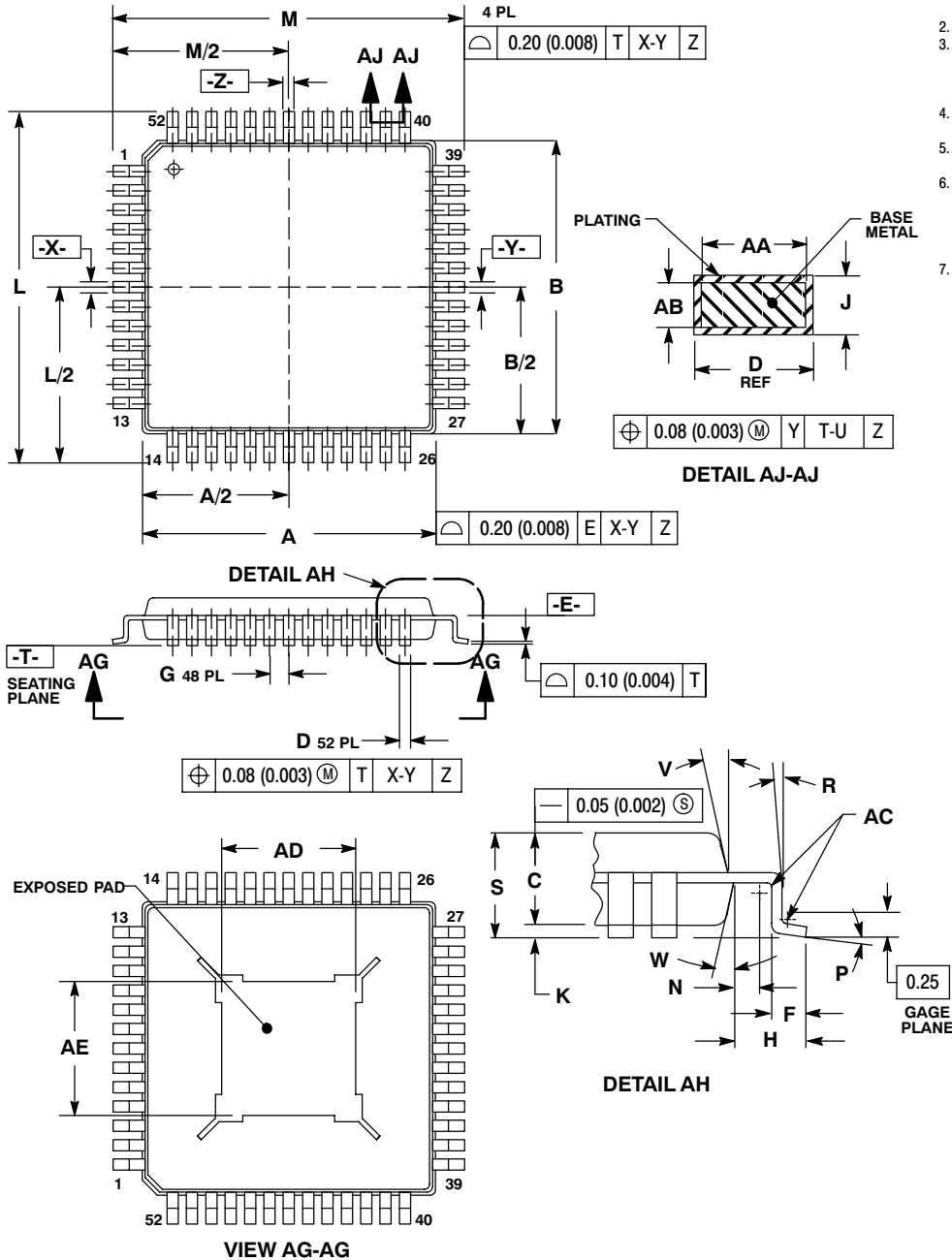

NOTES:

1. DIMENSIONING AND TOLERANCING PER ANSI Y14.5M, 1982.
2. CONTROLLING DIMENSION: MM.
3. DATUM PLANE "E" IS LOCATED AT BOTTOM OF LEAD AND IS COINCIDENT WITH THE LEAD WHERE THE LEAD EXITS THE PLASTIC BODY AT THE BOTTOM OF THE PARTING PLANE.
4. DATUM "X", "Y" AND "Z" TO BE DETERMINED AT DATUM PLANE DATUM "E".
5. DIMENSIONS M AND L TO BE DETERMINED AT SEATING PLANE DATUM "T".
6. DIMENSIONS A AND B DO NOT INCLUDE MOLD PROTRUSION. ALLOWABLE PROTRUSION IS 0.25 (0.010) PER SIDE. DIMENSIONS A AND B DO INCLUDE MOLD MISMATCH AND ARE DETERMINED AT DATUM PLANE "E".
7. DIMENSION D DOES NOT INCLUDE DAMBAR PROTRUSION. ALLOWABLE DAMBAR PROTRUSION SHALL NOT CAUSE THE LEAD WIDTH TO EXCEED THE MAXIMUM D DIMENSION BY MORE THAN 0.08 (0.003). DAMBAR CANNOT BE LOCATED ON THE LOWER RADIUS OR THE FOOT. MINIMUM SPACE BETWEEN PROTRUSION AND ADJACENT LEAD OR PROTRUSION 0.07 (0.003).

| DIM | MILLIMETERS | | INCHES | |
|-----|-------------|------|--------|-------|
| | MIN | MAX | MIN | MAX |
| A | 10.00 | BSC | 0.394 | BSC |
| B | 10.00 | BSC | 0.394 | BSC |
| C | 1.30 | 1.50 | 0.051 | 0.059 |
| D | 0.22 | 0.40 | 0.009 | 0.016 |
| F | 0.45 | 0.75 | 0.018 | 0.030 |
| G | 0.65 | BSC | 0.026 | BSC |
| H | 1.00 | REF | 0.039 | BSC |
| J | 0.09 | 0.20 | 0.004 | 0.008 |
| K | 0.05 | 0.20 | 0.002 | 0.008 |
| L | 12.00 | BSC | 0.472 | BSC |
| M | 12.00 | BSC | 0.472 | BSC |
| N | 0.20 | REF | 0.008 | REF |
| P | 0° | 7° | 0° | 7° |
| R | 0° | --- | 0° | --- |
| S | --- | 1.70 | --- | 0.067 |
| V | 12° | REF | 12° | REF |
| W | 12° | REF | 12° | REF |
| AA | 0.20 | 0.35 | 0.008 | 0.014 |
| AB | 0.07 | 0.16 | 0.003 | 0.006 |
| AC | 0.08 | 0.20 | 0.003 | 0.008 |
| AD | 4.58 | 4.78 | 0.180 | 0.188 |
| AE | 4.58 | 4.78 | 0.180 | 0.188 |

NB100LVEP221

PACKAGE DIMENSIONS

52 PIN QFN 8x8
CASE 485M-01
ISSUE A

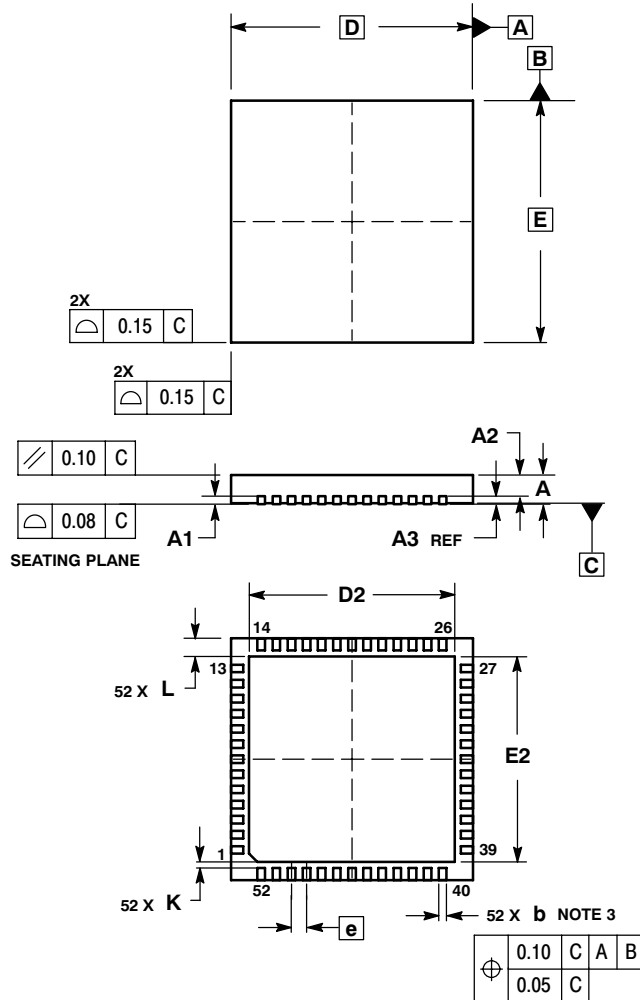

- NOTES:
1. DIMENSIONING AND TOLERANCING PER ASME Y14.5M, 1994.
 2. CONTROLLING DIMENSION: MILLIMETERS
 3. DIMENSION b APPLIES TO PLATED TERMINAL AND IS MEASURED BETWEEN 0.25 AND 0.30 MM FROM TERMINAL.
 4. COPLANARITY APPLIES TO THE EXPOSED PAD AS WELL AS THE TERMINALS.

| DIM | MILLIMETERS | |
|-----|-------------|------|
| | MIN | MAX |
| A | 0.80 | 1.00 |
| A1 | 0.00 | 0.05 |
| A2 | 0.60 | 0.80 |
| A3 | 0.20 | REF |
| b | 0.18 | 0.30 |
| D | 8.00 | BSC |
| D2 | 6.50 | 6.80 |
| E | 8.00 | BSC |
| E2 | 6.50 | 6.80 |
| e | 0.50 | BSC |
| K | 0.20 | -- |
| L | 0.30 | 0.50 |

EClinPS is a trademark of Semiconductor Components Industries, LLC (SCILLC).

ON Semiconductor and are registered trademarks of Semiconductor Components Industries, LLC (SCILLC). SCILLC reserves the right to make changes without further notice to any products herein. SCILLC makes no warranty, representation or guarantee regarding the suitability of its products for any particular purpose, nor does SCILLC assume any liability arising out of the application or use of any product or circuit, and specifically disclaims any and all liability, including without limitation special, consequential or incidental damages. "Typical" parameters which may be provided in SCILLC data sheets and/or specifications can and do vary in different applications and actual performance may vary over time. All operating parameters, including "Typicals" must be validated for each customer application by customer's technical experts. SCILLC does not convey any license under its patent rights nor the rights of others. SCILLC products are not designed, intended, or authorized for use as components in systems intended for surgical implant into the body, or other applications intended to support or sustain life, or for any other application in which the failure of the SCILLC product could create a situation where personal injury or death may occur. Should Buyer purchase or use SCILLC products for any such unintended or unauthorized application, Buyer shall indemnify and hold SCILLC and its officers, employees, subsidiaries, affiliates, and distributors harmless against all claims, costs, damages, and expenses, and reasonable attorney fees arising out of, directly or indirectly, any claim of personal injury or death associated with such unintended or unauthorized use, even if such claim alleges that SCILLC was negligent regarding the design or manufacture of the part. SCILLC is an Equal Opportunity/Affirmative Action Employer. This literature is subject to all applicable copyright laws and is not for resale in any manner.

PUBLICATION ORDERING INFORMATION

LITERATURE FULFILLMENT:
Literature Distribution Center for ON Semiconductor
P.O. Box 5163, Denver, Colorado 80217 USA
Phone: 303-675-2175 or 800-344-3860 Toll Free USA/Canada
Fax: 303-675-2176 or 800-344-3867 Toll Free USA/Canada
Email: orderlit@onsemi.com

N. American Technical Support: 800-282-9855 Toll Free
USA/Canada
Europe, Middle East and Africa Technical Support:
Phone: 421 33 790 2910
Japan Customer Focus Center
Phone: 81-3-5773-3850

ON Semiconductor Website: www.onsemi.com
Order Literature: <http://www.onsemi.com/orderlit>

For additional information, please contact your local Sales Representative

NB100LVEP221/D