



General Specifications

Allowable Ambient Temperature Range:

-10°C ~ +70°C (Operating)

-40°C ~ +70°C (Storage)

(non-condensing environment)

Motor Structure: Shaded Pole Induction Motor

Motor Protection: Impedance Protection

Outline

Units: $\frac{\text{inch}}{(\text{mm})}$

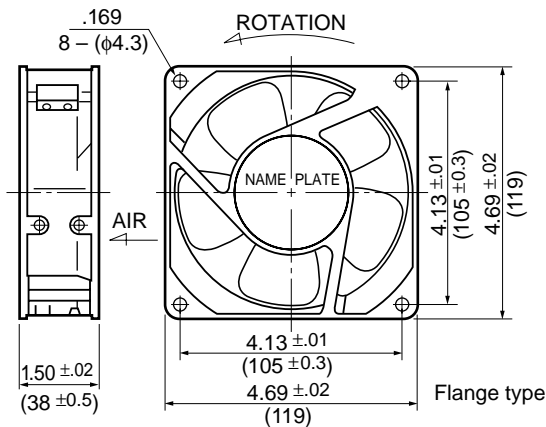

Panel Cut-outs

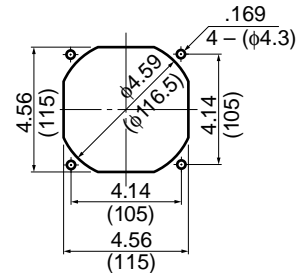

INLET SIDE / OUTLET SIDE

Material

Casing : Aluminum Alloy

Impeller : UL94V-O Reinforced Plastic

Bearing : Ball Bearings

Lead Wire: AWG22, UL3266, CSA CL1252

or Terminal: Faston #110 or equivalent

Specifications

MODEL	Rated Voltage	Frequency	Starting Voltage	Current	Input Power	Speed	Max. Air Flow		Max. Static Pressure		Noise	Mass
	(V)	(Hz)	(V)	(A)*1	(W) ^{+10% -20%}	(min ⁻¹)*2	CFM*2	(m ³ /min)*2	in H ₂ O	(Pa)*2	(dB)*2	(g)
4715FS-12T-B00-D00	115	60	75	0.090	7.5	1700	60.0	1.70	.08	20.0	31	550
4715FS-12T-B10-D00	115	60	75	0.110	10.0	1900	70.0	1.98	.12	30.0	33	550
4715FS-12T-B20-D00	115	60	75	0.100	9.8	2300	80.0	2.25	.13	32.5	36	550
4715FS-12T-B30-D00	115	60	75	0.180	14.5	2650	90.0	2.50	.22	55.0	39	550
4715FS-12T-B40-D00	115	60	75	0.170	14.0	2800	100.0	2.80	.29	72.5	42	550
4715FS-12T-B50-D00	115	60	75	0.190	14.4	3100	110.0	3.10	.37	92.5	45	550
4715FS-23T-B00-D00	230	60	175	0.030	5.5	1600	55.0	1.50	.07	17.5	30	550
4715FS-23T-B10-D00	230	60	175	0.050	9.0	1900	70.0	1.98	.12	30.0	33	550
4715FS-23T-B20-D00	230	60	175	0.050	8.8	2300	80.0	2.25	.13	32.5	36	550
4715FS-23T-B30-D00	230	60	175	0.090	12.0	2650	90.0	2.50	.22	55.0	39	550
4715FS-23T-B40-D00	230	60	175	0.090	14.0	2800	100.0	2.80	.28	70.0	42	550
4715FS-23T-B50-D00	230	60	175	0.080	14.0	3100	110.0	3.10	.37	92.5	45	550

Rotation: Counterclockwise

Airflow Outlet: Air In Over Struts

*1: Maximum Values in Free Air

*2: Average Values in Free Air