

# 3M™ Wiremount Plug

.100" × .100" Connector for .050" Pitch Cable

4600 Series



- Shrouded to protect against physical and chemical pin damage
- Open or closed end covers available
- Optional ejector latches
- Accepts flat cable or discrete wire
- Military (with 3518 polarizing key) and centerbump polarization available
- Optional mounting flanges
- Optional metal strain relief
- Appendix (RIA) in the "RoHS Compliance" section of [www.3M.com/Interconnects](http://www.3M.com/Interconnects) for compliance information (RIA E1 and C1 apply)

Date Modified: February 3, 2010

TS-0086-B  
Sheet 1 of 4

---

## Physical

### Insulator:

Material: Glass Filled Polyester (PBT)

Flammability: UL 94V-0

Color: Gray

### Contact:

Material: Copper Alloy

### Plating:

Underplating and U-Slot: 100 μ" [ 2.54 μm ] Nickel

Wiping Area: 30 μ" [ 0.76 μm ] Gold

Wire Accommodation: 26 and 28 AWG Solid and Stranded

**Marking:** 3M Logo, Part Identification Number, and Contact Position Numbers

---

## Electrical

**Current Rating:** 1 A

**Insulation Resistance:**  $> 1 \times 10^9 \Omega$  at 500 V<sub>DC</sub>

**Withstanding Voltage:** 1,000 V<sub>RMS</sub> at Sea Level

---

## Environmental

**Temperature Rating:** -55°C to +105°C

UL File No.: E68080

---

**3M**

Electronic Solutions Division  
Interconnect Solutions  
<http://www.3M.com/interconnects/>

3M is a trademark of 3M Company.  
For technical, sales or ordering information call  
**800-225-5373**

# 3M™ Wiremount Plug

.100" x .100" Connector for .050" Pitch Cable

4600 Series

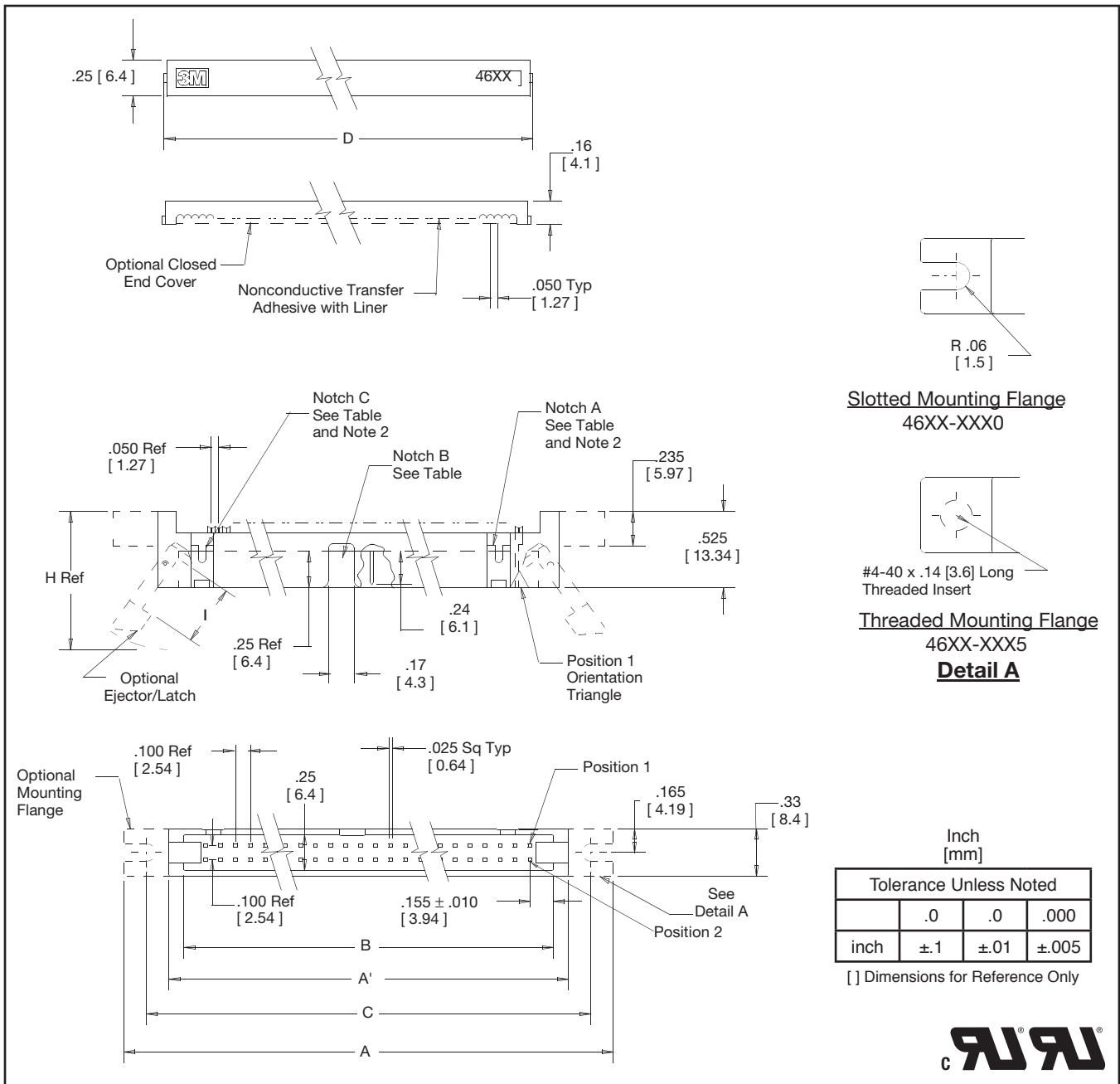

## Ordering Information

### 46XX - XXXX

Contact Quantity:  
See Table

Cover Style:  
**6 = Open End (Daisy Chaining/Bussing - Standard)**  
 7 = Closed End (End Cable Termination)

Ejector/Latch System:  
**0 = None (Standard)**  
 2 = Short Ejector Latch (3505-16)  
 3 = Long Ejector Latch (3505-17)  
 7 = Universal Ejector Latch (3505-21)

Polarization:  
 0 = for Contact Qty 14 to 64  
 0 = for Notch C on 10 Position  
 5 = for Notch B on 10 Position

Body Style:  
**0 = w/Mounting Flange (Standard)** (RIA E1 & C1 Apply)  
 1 = w/o Mounting Flange (RIA E1 & C1 Apply)  
 5 = Mounting Flanges w/ Threaded Insert from Socket mating side (RIA E5 & C3 Apply)

Contact Quantity:  
See Table

### Strain Relief (Order Separately) 3448 - 46XX

Assembly tools: 3M™ Press, 3640 (or equivalent) ; 3M™ Locator Plate, 3443-96; 3M™ Platen, 3442-9

TS-0086-B  
Sheet 2 of 4

**3M**  
 Electronic Solutions Division  
 Interconnect Solutions  
<http://www.3M.com/interconnects/>

3M is a trademark of 3M Company.  
 For technical, sales or ordering information call  
**800-225-5373**

# 3M™ Wiremount Plug

.100" x .100" Connector for .050" Pitch Cable

4600 Series

Pin Qty	Dimensions						Polarizing Notches Provided
	A	A'	B	C	D	E	
10	1.50 [38.1]	0.90 [22.9]	0.71 [18.0]	1.20 [30.5]	0.77 [19.6]	0.85 [21.6]	B or C (See Note 1)
14	1.70 [43.2]	1.10 [27.9]	0.91 [23.1]	1.40 [35.6]	0.97 [24.6]	1.05 [26.7]	BC
16	1.80 [45.7]	1.20 [30.5]	1.01 [25.7]	1.50 [38.1]	1.07 [27.2]	1.15 [29.2]	ABC
20	2.00 [50.8]	1.40 [35.6]	1.21 [30.7]	1.70 [43.2]	1.27 [32.3]	1.35 [34.3]	ABC
24	2.20 [55.9]	1.60 [40.6]	1.41 [35.8]	1.90 [48.3]	1.47 [37.3]	1.55 [41.9]	ABC
26	2.30 [58.4]	1.70 [43.2]	1.51 [38.4]	2.00 [50.8]	1.57 [39.9]	1.65 [46.9]	ABC
30	2.50 [63.5]	1.90 [48.3]	1.71 [43.4]	2.20 [55.9]	1.77 [45.0]	1.85 [47.1]	ABC
34	2.70 [68.6]	2.10 [53.3]	1.91 [48.5]	2.40 [61.0]	1.97 [50.0]	2.05 [52.1]	ABC
36	2.80 [71.1]	2.20 [55.9]	2.01 [51.1]	2.50 [63.5]	2.07 [52.6]	2.15 [54.6]	ABC
40	3.00 [76.2]	2.40 [61.0]	2.21 [56.1]	2.70 [68.6]	2.27 [57.7]	2.35 [59.7]	ABC
50	3.50 [88.9]	2.90 [73.7]	2.71 [68.8]	3.20 [81.3]	2.77 [70.4]	2.85 [72.4]	ABC
60	4.00 [101.6]	3.40 [86.4]	3.21 [81.5]	3.70 [94.0]	3.27 [83.1]	3.35 [85.1]	ABC
64	4.20 [106.7]	3.60 [91.4]	3.41 [86.6]	3.90 [99.1]	3.47 [88.1]	3.55 [90.2]	ABC

Ejector/Latch Option	Part Number	Dimensions			
		F	G	H	I
Short	3505-16	.335 [8.51]	.726 [18.44]	0.92 [23.4]	.41 [10.4]
Long	3505-17	.484 [12.29]	.875 [22.23]	1.07 [27.2]	.56 [14.2]
Universal	3505-21	.484 [12.29]	.809 [20.55]	1.01 [25.65]	.56 [14.2]

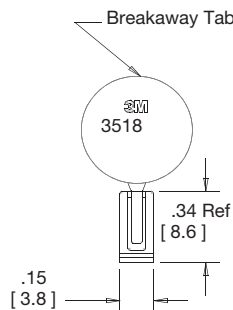

**3M Part No 3518**

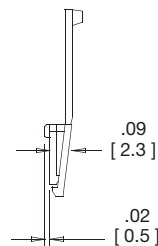

**Polarizing Key**  
(Order Separately)

Material: Gray Glass Filled Polyester

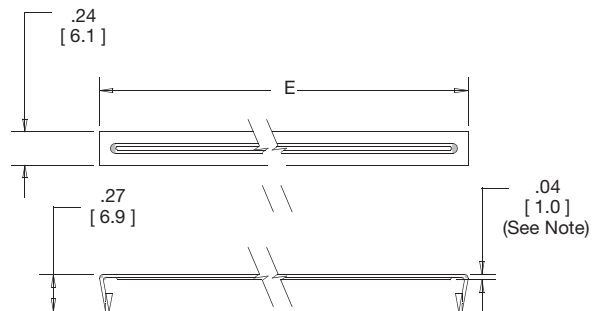

**Strain Relief**

Material .012" [0.30] Thick  
Stainless Steel

**Ejector/Latch**

Material: Gray Glass Filled Polyester

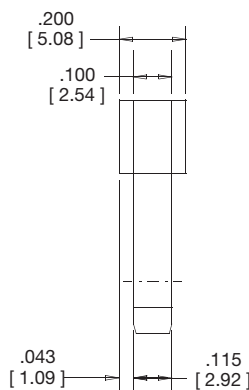

**3505-21**

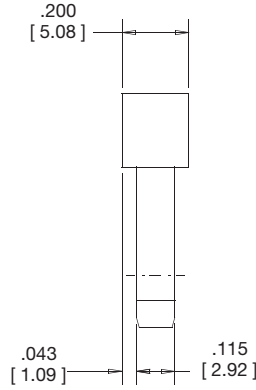

**3505-16**  
**3505-17**

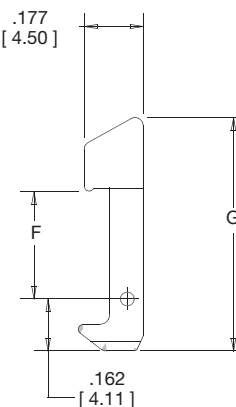

**Notes:**

The distance from the strain relief to the connector is equal to .04 [1.0] plus the cable thickness.

TS-0086-B  
Sheet 3 of 4

# 3M™ Wiremount Plug

.100" × .100" Connector for .050" Pitch Cable

4600 Series

Table 3

Contact Quantity	3M Part Number Series	Dimension A	Dimension B
10	4610	1.200 [ 30.48 ]	0.945 [ 24.00 ]
14	4614	1.400 [ 35.56 ]	1.145 [ 29.08 ]
16	4616	1.500 [ 38.10 ]	1.245 [ 31.62 ]
20	4620	1.700 [ 43.18 ]	1.445 [ 36.70 ]
24	4624	1.900 [ 48.26 ]	1.645 [ 41.78 ]
26	4626	2.000 [ 50.80 ]	1.745 [ 44.32 ]
30	4630	2.200 [ 55.88 ]	1.945 [ 49.40 ]
34	4634	2.400 [ 60.96 ]	2.145 [ 54.48 ]
36	4636	2.500 [ 63.50 ]	2.245 [ 57.02 ]
40	4640	2.700 [ 68.58 ]	2.445 [ 62.10 ]
50	4650	3.200 [ 81.28 ]	2.945 [ 74.80 ]
60	4660	3.700 [ 93.98 ]	3.445 [ 87.50 ]
64	4664	3.900 [ 99.06 ]	3.645 [ 92.58 ]

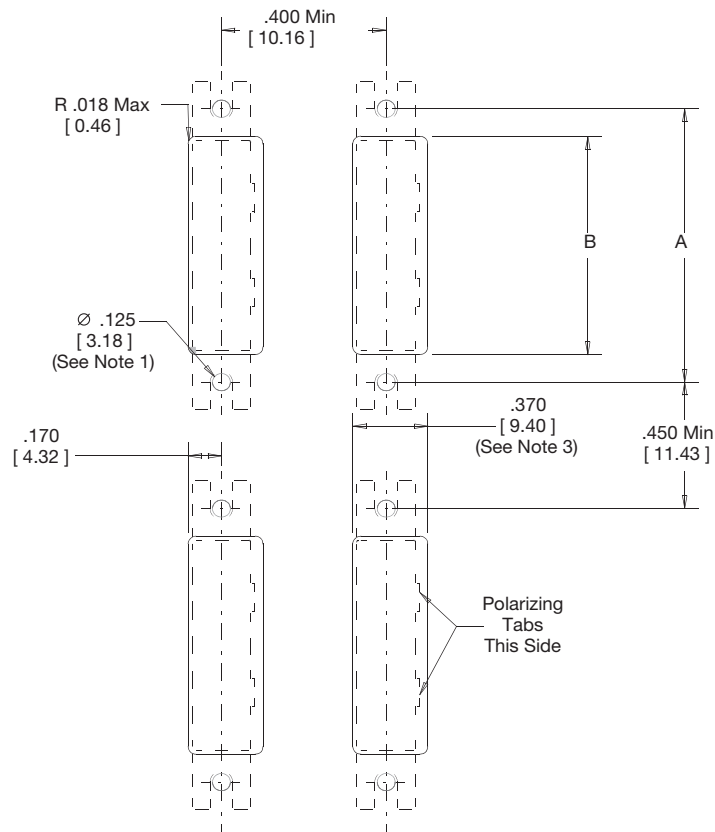

Rear Mount Panel Cutout

Notes:

1. Accepts #4 pan head machine screw.
2. For a rear mount plug connector with Ejector/Latches the recommended maximum panel thickness is .125 [ 3.18 ].
3. Without polarizing tabs .340 [ 8.64 ].

TS-0086-B  
Sheet 4 of 4

**Important Notice**

All statements, technical information, and recommendations related to 3M's products are based on information believed to be reliable, but the accuracy or completeness is not guaranteed. Before using this product, you must evaluate it and determine if it is suitable for your intended application. You assume all risks and liability associated with such use. Any statements related to the product which are not contained in 3M's current publications, or any contrary statements contained on your purchase order shall have no force or effect unless expressly agreed upon, in writing, by an authorized officer of 3M.

**Warranty; Limited Remedy; Limited Liability.**

This product will be free from defects in material and manufacture for a period of one (1) year from the time of purchase. **3M MAKES NO OTHER WARRANTIES INCLUDING, BUT NOT LIMITED TO, ANY IMPLIED WARRANTY OF MERCHANTABILITY OR FITNESS FOR A PARTICULAR PURPOSE.** If this product is defective within the warranty period stated above, your exclusive remedy shall be, at 3M's option, to replace or repair the 3M product or refund the purchase price of the 3M product. **Except where prohibited by law, 3M will not be liable for any indirect, special, incidental or consequential loss or damage arising from this 3M product, regardless of the legal theory asserted.**

**3M Electronics Solutions Division**

6801 River Place Blvd.  
Austin, TX 78726-9000  
U.S.A.  
1-800-225-5373  
[www.3Mconnector.com](http://www.3Mconnector.com)

Please recycle. Printed in USA.  
© 3M 2010. All rights reserved.  
RIA-2217B-E

3M is a trademark of 3M Company.