

MMBV432LT1

Preferred Device

Silicon Tuning Diode

This device is designed for FM tuning, general frequency control and tuning, or any top-of-the-line application requiring back-to-back diode configuration for minimum signal distortion and detuning. This device is supplied in the SOT-23 plastic package for high volume, pick and place assembly requirements.

Features

- High Figure of Merit – $Q = 150$ (Typ) @ $V_R = 2.0$ Vdc, $f = 100$ MHz
- Guaranteed Capacitance Range
- Dual Diodes – Save Space and Reduce Cost
- Surface Mount Package
- Available in 8 mm Tape and Reel
- Monolithic Chip Provides Improved Matching – Guaranteed $\pm 1.0\%$ (Max) Over Specified Tuning Range
- Pb-Free Package is Available

MAXIMUM RATINGS (Each Diode)

Rating	Symbol	Value	Unit
Reverse Voltage	V_R	14	Vdc
Forward Current	I_F	200	mAdc
Total Power Dissipation @ $T_A = 25^\circ\text{C}$ Derate above 25°C	P_D	225 1.8	mW mW/ $^\circ\text{C}$
Junction Temperature	T_J	+125	$^\circ\text{C}$
Storage Temperature Range	T_{stg}	-55 to +125	$^\circ\text{C}$

Maximum ratings are those values beyond which device damage can occur. Maximum ratings applied to the device are individual stress limit values (not normal operating conditions) and are not valid simultaneously. If these limits are exceeded, device functional operation is not implied, damage may occur and reliability may be affected.



ON Semiconductor®

<http://onsemi.com>

DUAL VOLTAGE VARIABLE CAPACITANCE DIODE

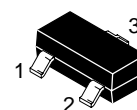
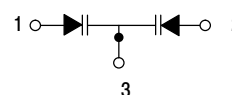

SOT-23 (TO-236)
CASE 318
STYLE 9

MARKING DIAGRAM

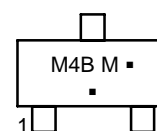

M4B = Specific Device Code
M = Date Code*
▪ = Pb-Free Package

(Note: Microdot may be in either location)

*Date Code orientation and/or overbar may vary depending upon manufacturing location.

ORDERING INFORMATION

Device	Package	Shipping†
MMBV432LT1	SOT-23	3,000 / Tape & Reel
MMBV432LT1G	SOT-23 (Pb-Free)	3,000 / Tape & Reel

†For information on tape and reel specifications, including part orientation and tape sizes, please refer to our Tape and Reel Packaging Specifications Brochure, BRD8011/D.

Preferred devices are recommended choices for future use and best overall value.

MMBV432LT1

ELECTRICAL CHARACTERISTICS (EACH DIODE) ($T_A = 25^\circ\text{C}$ unless otherwise noted)

Characteristic	Symbol	Min	Typ	Max	Unit
Reverse Breakdown Voltage ($I_R = 10 \mu\text{A}$)	$V_{(BR)R}$	14	–	–	Vdc
Reverse Voltage Leakage Current ($V_R = 9.0 \text{ Vdc}$)	I_R	–	–	100	nAdc
Diode Capacitance ($V_R = 2.0 \text{ Vdc}$, $f = 1.0 \text{ MHz}$)	C_T	43	–	48.1	pF
Capacitance Ratio C_2/C_8 ($f = 1.0 \text{ MHz}$)	C_R	1.5	–	2.0	–
Figure of Merit ($V_R = 2.0 \text{ Vdc}$, $f = 100 \text{ MHz}$)	Q	100	150	–	–

MMBV432LT1

TYPICAL CHARACTERISTICS (Each Diode)

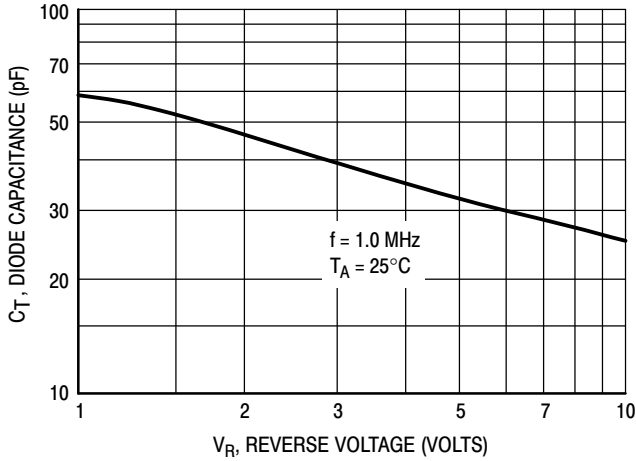

Figure 1. Diode Capacitance

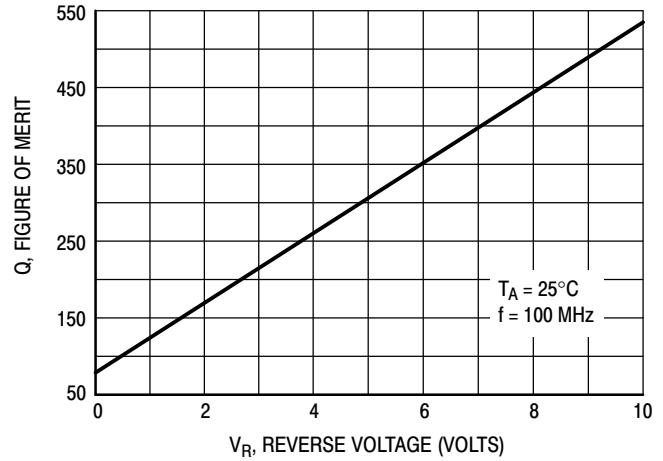

Figure 2. Figure of Merit versus Voltage

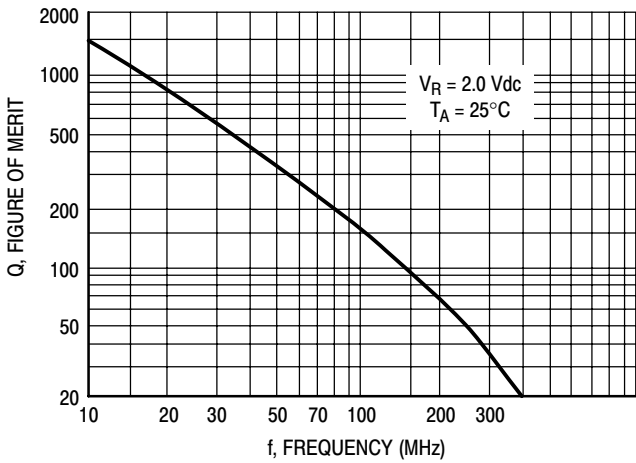

Figure 3. Figure of Merit versus Frequency

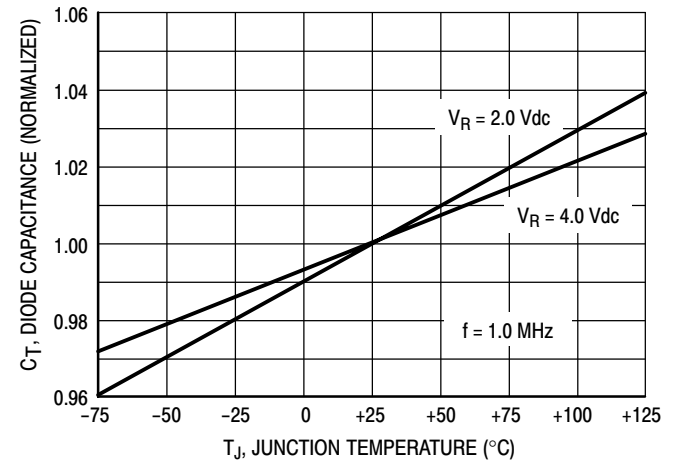

Figure 4. Diode Capacitance versus Temperature

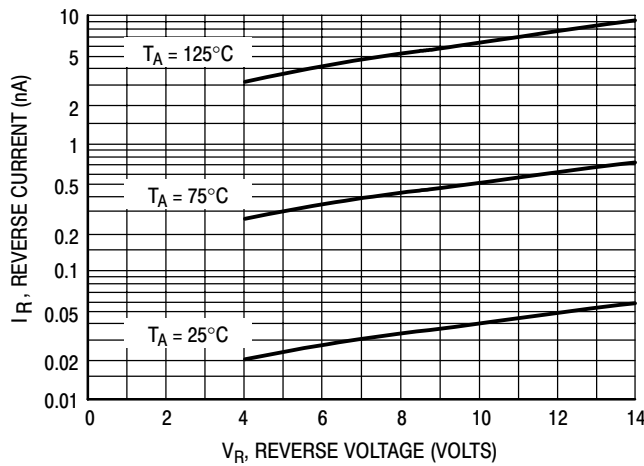
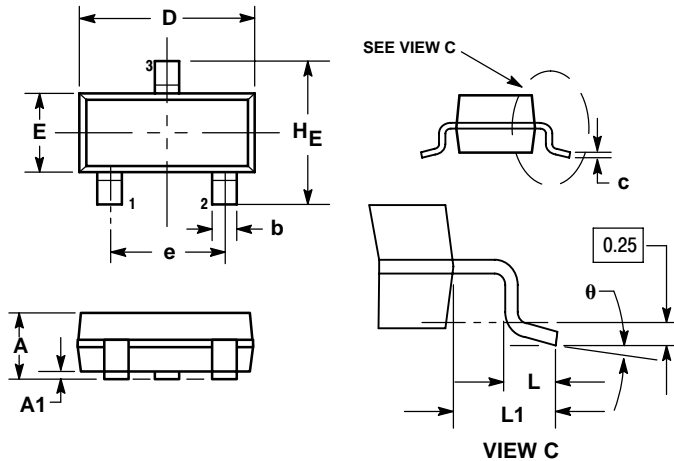

Figure 5. Reverse Current versus Reverse Voltage

MMBV432LT1

PACKAGE DIMENSIONS

SOT-23 (TO-236)
CASE 318-08
ISSUE AN



NOTES:

1. DIMENSIONING AND TOLERANCING PER ANSI Y14.5M, 1982.
2. CONTROLLING DIMENSION: INCH.
3. MAXIMUM LEAD THICKNESS INCLUDES LEAD FINISH THICKNESS. MINIMUM LEAD THICKNESS IS THE MINIMUM THICKNESS OF BASE MATERIAL.
4. 318-01 THRU -07 AND -09 OBSOLETE, NEW STANDARD 318-08.

DIM	MILLIMETERS			INCHES		
	MIN	NOM	MAX	MIN	NOM	MAX
A	0.89	1.00	1.11	0.035	0.040	0.044
A1	0.01	0.06	0.10	0.001	0.002	0.004
b	0.37	0.44	0.50	0.015	0.018	0.020
c	0.09	0.13	0.18	0.003	0.005	0.007
D	2.80	2.90	3.04	0.110	0.114	0.120
E	1.20	1.30	1.40	0.047	0.051	0.055
e	1.78	1.90	2.04	0.070	0.075	0.081
L	0.10	0.20	0.30	0.004	0.008	0.012
L1	0.35	0.54	0.69	0.014	0.021	0.029
HE	2.10	2.40	2.64	0.083	0.094	0.104

STYLE 9:

1. ANODE
2. ANODE
3. CATHODE

SOLDERING FOOTPRINT*

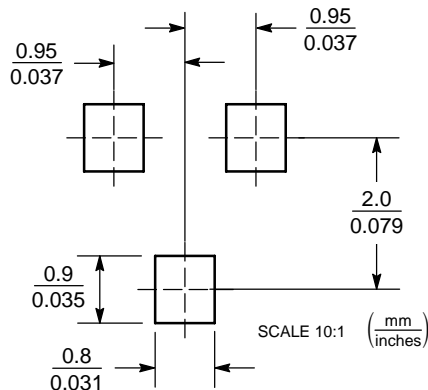

*For additional information on our Pb-Free strategy and soldering details, please download the ON Semiconductor Soldering and Mounting Techniques Reference Manual, SOLDERRM/D.

ON Semiconductor and are registered trademarks of Semiconductor Components Industries, LLC (SCILLC). SCILLC reserves the right to make changes without further notice to any products herein. SCILLC makes no warranty, representation or guarantee regarding the suitability of its products for any particular purpose, nor does SCILLC assume any liability arising out of the application or use of any product or circuit, and specifically disclaims any and all liability, including without limitation special, consequential or incidental damages. "Typical" parameters which may be provided in SCILLC data sheets and/or specifications can and do vary in different applications and actual performance may vary over time. All operating parameters, including "Typicals" must be validated for each customer application by customer's technical experts. SCILLC does not convey any license under its patent rights nor the rights of others. SCILLC products are not designed, intended, or authorized for use as components in systems intended for surgical implant into the body, or other applications intended to support or sustain life, or for any other application in which the failure of the SCILLC product could create a situation where personal injury or death may occur. Should Buyer purchase or use SCILLC products for any such unintended or unauthorized application, Buyer shall indemnify and hold SCILLC and its officers, employees, subsidiaries, affiliates, and distributors harmless against all claims, costs, damages, and expenses, and reasonable attorney fees arising out of, directly or indirectly, any claim of personal injury or death associated with such unintended or unauthorized use, even if such claim alleges that SCILLC was negligent regarding the design or manufacture of the part. SCILLC is an Equal Opportunity/Affirmative Action Employer. This literature is subject to all applicable copyright laws and is not for resale in any manner.

PUBLICATION ORDERING INFORMATION

LITERATURE FULFILLMENT:
Literature Distribution Center for ON Semiconductor
P.O. Box 61312, Phoenix, Arizona 85082-1312 USA
Phone: 480-829-7710 or 800-344-3860 Toll Free USA/Canada
Fax: 480-829-7709 or 800-344-3867 Toll Free USA/Canada
Email: orderlit@onsemi.com

N. American Technical Support: 800-282-9855 Toll Free
USA/Canada

Japan: ON Semiconductor, Japan Customer Focus Center
2-9-1 Kamimeguro, Meguro-ku, Tokyo, Japan 153-0051
Phone: 81-3-5773-3850

ON Semiconductor Website: <http://onsemi.com>

Order Literature: <http://www.onsemi.com/litorder>

For additional information, please contact your local Sales Representative.

MMBV432LT1/D