

Sequencer sub-bases

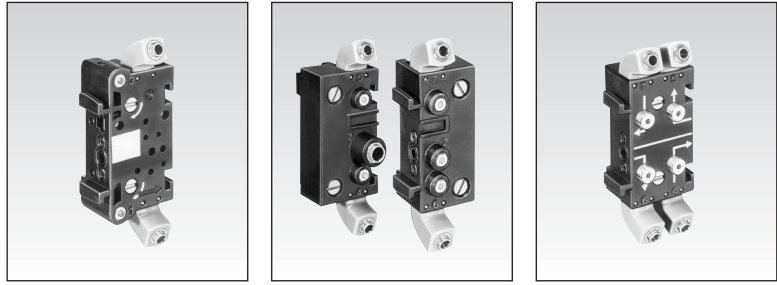

Part numbers

Front connecting (DIN-omega)

81 551 101

Sub-base (DIN omega)

81 552 102

End bases - 1 pair
entry & exit modules

81 552 601

Diversion base

1

Characteristics

Sub-bases Rotatable connectors
Pressure indicators

Weight	grams	55	135	60
--------	-------	----	-----	----

Sequencer connections

Front connecting

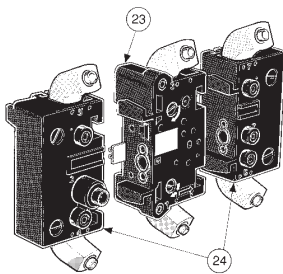

- 1 - Input port (green - port 1) \varnothing 5/32" (4 mm)
- 2 - Output port (red - port 3) \varnothing 5/32" (4 mm)
- 3 - Input port, cycle start (green - port 4) \varnothing 5/32" (4 mm)
- 4 - Output port, in-cycle signal (red - port 5) \varnothing 5/32" (4 mm)
- 5 - Supply port (yellow - port 2) \varnothing 1/4" (6.35 mm)
- 6 - Output port, end of cycle (red - port 6) \varnothing 5/32" (4 mm)
- 7 - Input port, reset to zero (green - port 7) \varnothing 5/32" (4 mm)
- 8 - Output indicator (red)
- 9 - Input indicator (green)
- 10 - Cycle start indicator at port 4 (green)
- 11 - In-cycle indicator at port 5 (red)
- 12 - Input indicator at port 7 (green)
- 13 - End of cycle indicator at port 6 (red)
- 14 - Supply indicator at port 2 (yellow)
- 15 - Interconnecting ports
- 16 - Mounting screws
- 17 - Engraved arrow to indicate direction of sequence
- 18 - Marking tag
- 19 - Marking tag position
- 20 - Marking tag position
- 21 - Mounting tongue
- 22 - Mounting groove
- 23 - Sub-base
- 24 - End bases

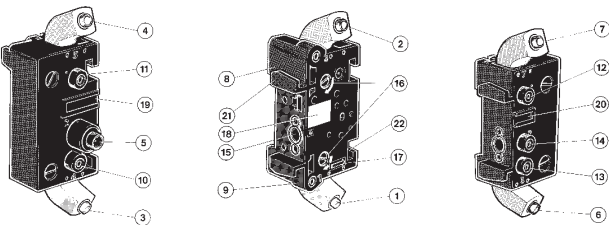

Dimensions

Front connecting

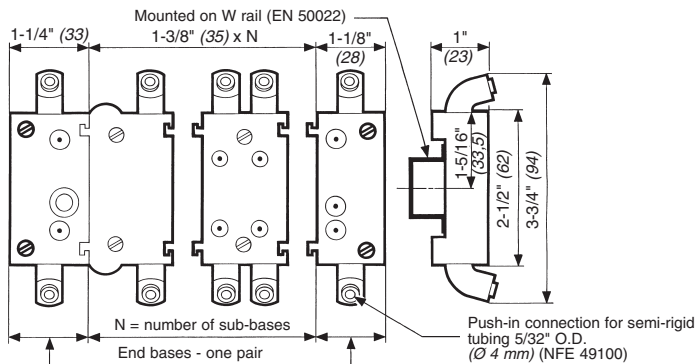

Finished product on DR rail

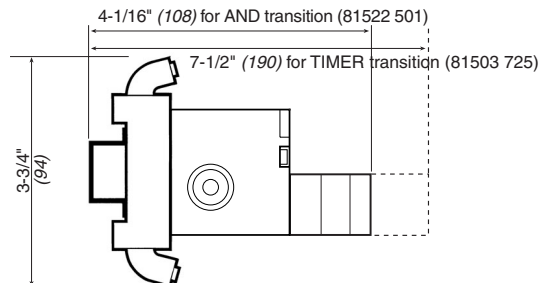

Use (metric) dimensions for critical data.

Products and specifications subject to change without notice.

Order/Technical Support – Tel: (800) 677-5311 / FAX: (800) 677-3865 / www.crouzet-usa.com

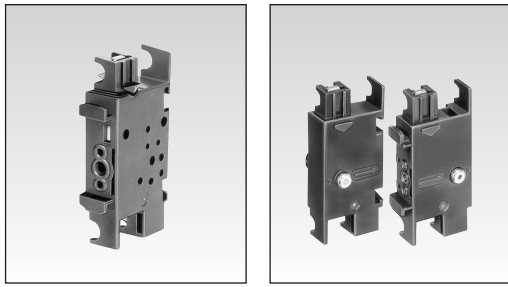

81 551 001	81 552 001
Sub-base (with clips)	End bases - one pair entry & exit modules
—	—
40	120

1

Rear connecting

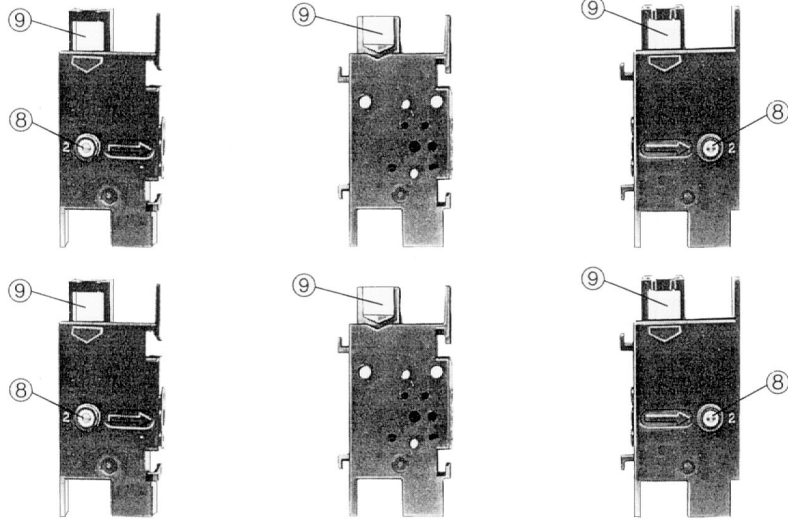

- 1 - Input port (marked port 1)
- 2 - Supply port (Port 2)
- 3 - Output port (Port 3)
- 4 - Cycle start signal port (Port 4)
- 5 - In-cycle signal port (Port 5)
- 6 - End of cycle signal port (Port 6)
- 7 - Reset to zero signal port (Port 7)
- 8 - Indicator at supply port
- 9 - Marking area

Rear connecting

Finished product on 5/16" rods.

Push-in connection for semi-rigid tubing 5/32" O.D.
(Ø 4 mm) (NFE 49100)

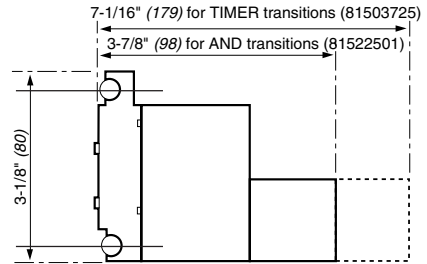
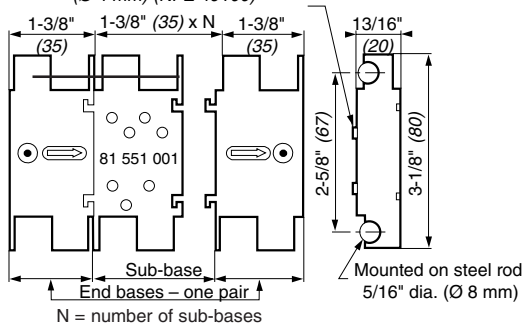

Use (metric) dimensions for critical data.

To order, specify :

Standard products

1 Part number

Example : Sequencer sub-bases - 81 551 101

Products and specifications subject to change without notice.

Order/Technical Support – Tel: (800) 677-5311 / FAX: (800) 677-3865 / www.crouzet-usa.com

