

# enGage II: Programmable Maintenance Monitor 3003R-67X-0001



## Technical Specifications

**Operating Voltage Range** 12V-48VDC nominal voltage, +/- 25%

**Operating Current Range** Nominal- 14 mA, maximum 20 mA. Values reflect key switch in "on" position

**Display:** LCD with 10-segment bar and 5 digit numeric (5mm high)

**Hour Meter Range** 9,999.9 Maintenance Hours

**& Resolution:** 99,999 Total Hours

**Hardware:** Mounting Bracket

**Panel Cutout:** 52 mm / 2 1/16" diameter

**Shock** SAE J 1378 Amplitude

44-55 g, half sine, 9-13 ms duration

**Vibration** SAE J 1378 Double amplitude of 1.53mm with frequency sweep for 10-80-10 Hz (20 g max) at 1 minute intervals

**Storage Temperature:** -50°C to +90°C

**Operating Temperature:** -40°C to +85°C

**Humidity:** 95% RH (non-condensing)

**IP Rating:** 65 Front & Rear with AMP connector installed

Description	AMP Pin #
<b>(V+) Supply voltage positive terminal</b>	4
<b>(V-) Supply voltage negative terminal</b>	8
<b>Key switch (+):</b> When V+ is applied this switch operates the gauge display.	6
<b>MOSFET output:</b> MOSFET (0.5A) open drain type internally tied to V-.	7
<b>Setup Enable (+):</b> When V+ applied, gauge can be programmed via panel buttons.	2
<b>Hour Meter Enable (+):</b> When V+ applied, accumulation of time occurs when key switch on.	3

## Configuring Your Gauge

Access to these operations is sequential in this order. Adjustments of the following functions can be performed in the Configuration Mode:

1. Time-of-Day Clock
2. Maintenance interval

During configuration, the *right* button is used to increment. The *left* button is used to:

1. Enter a selection
2. Advance to the next configurable item

If no change is desired to a specific gauge function, continue to press the left button until the next desired function is reached. The time-of-day clock is entered by setting the hours digits between 01 and 12, then "minutes" digits between "00" and "59".

The maintenance interval (when the gauge signals that maintenance is due) is configurable and should be set after the initial installation. The interval can be set between 1 and 9,999 hours in 1 hour increments.

### Setting the Maintenance Interval

Apply V+ (9 to 60VDC to the set up enable pin (2). Press and hold the Left button on the front panel until the display flashes and then release. The display will flash the two "Hours" digits, Press the left button once. The display will flash the two "Minutes" digits, Press the left button once. The display will flash the maintenance left digit (thousands of hours). Press the right button to increment by one or hold the button to increment continuously. When the desired number is reached, press the left button once to proceed to the next digit. Repeat this process for all 4 digits. Press the left button once to exit.

### Setting the Time-of-Day Clock

This can be done without V+ applied to Setup Enable pin. Press and hold the left button on the front panel until the entire display flashes and then release.

The display will flash the two "Hours" digits. Press the right button to increment by one hour, or hold the button to increment continuously. When the desired number of hours is reached, press the left button once. The display will flash the two "Minutes" digits. Press the right button to increment by one minute or hold the button to increment continuously. When the desired number of minutes is reached, press the left button once.

## Configuration Notes

The gauge remains in configuration mode for 30 seconds without input from the user. When configuring each function (time-of-day, maintenance interval, etc.), you must enter in all data for that function for it to be saved. If incomplete data is entered for a function and the programming mode is timed out (after 30 seconds of no input received by the gauge), the gauge will revert back to what was previously stored for that item.

### Exiting Configuration Mode

The configuration mode can be exited in three ways:

1. Press and hold the left button for three seconds.
2. Leave buttons untouched for 30 seconds.
3. Press the left button after selecting the last (right) digit of the last function available.

## Operation

When the main power (9-60 VDC) is applied to V+ and V-, a power-up sequence is initiated. All display segments are illuminated for one second. The display is then turned off until the key switch is activated.

### Toggling Display Functions

Press the left button to sequentially toggle between the two numeric gauge functions (time-of-day clock, maintenance hours).

### Resetting the Maintenance Hour Meter

This can be done without V+ applied to Setup Enable pin. Press the left button until the maintenance hour meter function is displayed (the wrench icon will be illuminated). Press and hold both the right button and the left button until the display flashes and the maintenance hour meter is reset to the preset maintenance period. Release the right button first. This reset function can be performed at any time, independent of the actual maintenance status.

## Maintenance

The enGage™II 3000 Series is not serviceable.





## Safety Instructions

- This instrument was manufactured and tested according to the applicable technical standards. It complies with all the safety regulations as shipped from the factory.
- Installation and startup must be performed by skilled personnel.
- Failure to install and operate the unit in accordance with these instructions may result in damage or injury.
- If safe operation of the instrument can no longer be ensured, stop and secure it against accidental operation.
- If instrument failure or malfunction may cause personal injury or material damage, use additional safety measures such as limit switches, guards, etc.
- Read the Operating Instructions carefully before startup.
- Note the safety instructions marked with this warning symbol in this manual.

## Guarantee

Curtis Instruments' products and/or components are guaranteed against defects in workmanship and material for a period of two years, or as defined in the individual product literature, from date of shipment from our factory, when applied in a proper application within specified ratings. This guarantee is limited to repair or replacement F.O.B. our factory. There is no further warranty or implied representation, guarantee, promise or agreement as to any Curtis Instruments product and/or component. Curtis Instruments, Inc., cannot assume responsibility or accept invoices for unauthorized repairs to its products and/or components, even though defective. In no case will Curtis Instruments' responsibility extend to products, components or equipment not of its manufacture. Under no circumstances shall Curtis Instruments, Inc. be liable for any special or consequential damages or loss of profits or other damages. Returned goods will not be accepted unless identified by a Curtis Return Material Authorization (RMA). All specifications are subject to change without notice.

## LCD Icons

1.  **Hourglass Icon** - Turned on (not blinking) to indicate that an hour meter is displayed in the numeric display. Flashes to indicate hour meter accumulation.
2.  **Wrench Icon** - Turned on (not blinking) to indicate that the maintenance hour meter is displayed in the numeric display. Flashes when the maintenance interval is reached.
3.  **Colon** - Flashes to indicate that the time-of-day clock is being displayed in the numeric display and that time is counting-up.
4.  **Decimal Point** - To indicate 1/10 of an hour on the maintenance hour meter
5.  **Percent** - Indicates remaining percentage of interval or level.

## Troubleshooting

### Maintenance Monitor Function

Problem	Possible Cause
Will not reset	Resetting procedure not being followed
Will not/can not configure maintenance interval	No Power to set up enable pin

## Notes

1. Mating connector; 8-pin AMP, P/N 794821-1 with UL rating 94V-0. Interface seal, P/N 794772-0. Wire seal 794758-1, Pins P/N770904-X for #18-24 AWG.
2. Material: Case-polycarbonate, lens-clear polymethylmethacrylat (PMMA) cover, overlay and mounting bracket-polycarbonate.
3. This unit is designed for a mounting panel thickness of 0.8mm-6.4mm.
4. Panel cutout: 52mm diameter dash panel hole.

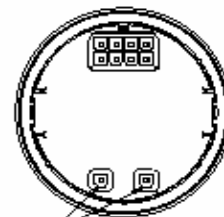

USED FOR DEVICE CONFIGURATION  
DO NOT CONNECT WHEN INSTALLING GAGE

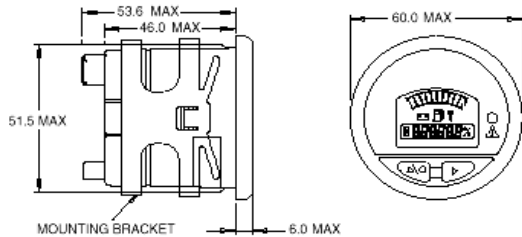

CAUTION!  
BRACKET IS PLACED OVER GAUGE IN REVERSE FASHION FOR EASE OF SHIPPING. BRACKET HAS BEEN DESIGNED TO REMAIN SECURED TO THE GAUGE UPON PROPER INSTALLATION. ONCE INSTALLED CORRECTLY, ATTEMPTS TO REMOVE BRACKET FROM GAUGE MAY RESULT IN DAMAGE TO THE BRACKET.

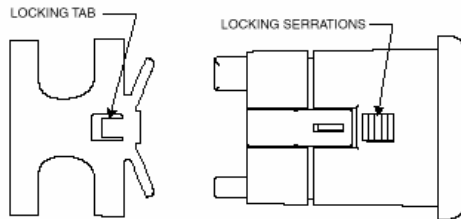

LOCKING TAB MUST ALIGN WITH LOCKING SERRATIONS

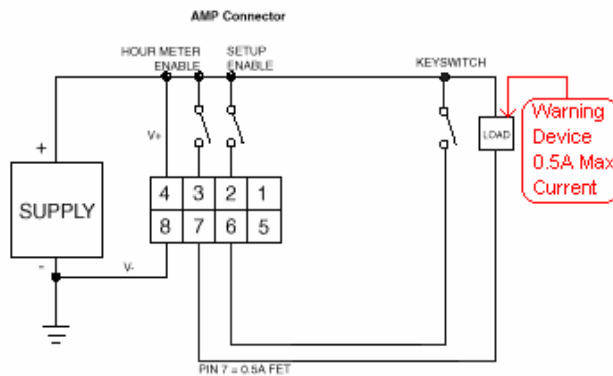

Warning Device  
0.5A Max Current

## Installation Procedure

1. Mount unit in standard SAE round cutout.
2. Connect supply voltage to pins indicated: (V+) pin 4, (V-) pin 8.
3. Connect pin 6, as appropriate for key switch, to enable gauge display.
4. Connect pin 3 as appropriate to activate the hour meter.
5. Connect pin 2 to a hidden enable switch.
6. Connect pin 7 to an audio, visual, horn, or other warning device (load). **Caution:** Max current draw on warning device is **0.5 Amps**.

## Installation

### Caution!

Bracket has been designed to remain secured to the gauge upon proper installation. Once installed correctly, attempts to remove bracket from gauge may result in damage to the bracket.

Curtis enGage™ II instruments are mounted in a 52mm round cutout. Serrations on the barrel of the gauge, combined with the mounting bracket provided, insure fast and trouble free installation. To insure proper installation, the 2 locking tabs on either side of the inner diameter of the bracket should be aligned with the serrations on the barrel of the gauge (see drawing above). Next, slide the bracket over the barrel of the gauge and press it firmly against back of panel. You should hear the tab sliding over the serrations.

Curtis enGage™ II mates with an 8-pin AMP connector (AMP pins P/N 770904-X FOR #18-24 AWG P/N 794821-1).

A preassembled mating connector kit (Curtis P/N 17631800-01) with crimp-connect terminated wires (approx. 5 inches in length) is also available.

## Output and Warning LED

Function	LED Activated	FET Shut off
Maintenance Due	LMB	LMB

### KEY

1. **RMB** = Right Most LCD Bar
2. **LMB** = Left Most LCD Bar.