

9V (±5V) POWERED DPM CONNECTIONS

+5V POWERED DPM CONNECTIONS

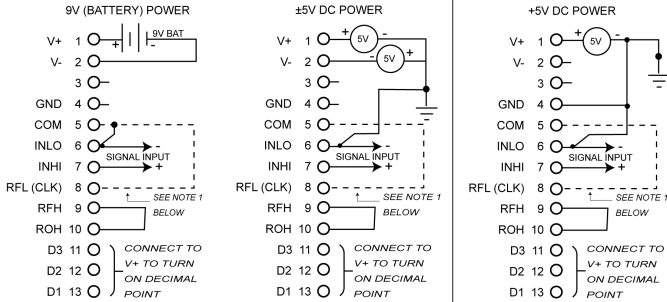

- NOTES:
- DO NOT MAKE THE CONNECTION BETWEEN "COM" & "RFL" ON DPMs WITH HOLD OPTION.
 - INPUT MUST BE ISOLATED FROM SUPPLY WITH 9V CONNECTION SHOWN.
 - DO NOT SOLDER TO .025" PINS
 - THE 5V BACKLIGHT POWER IS SEPARATE FROM THE DPM POWER. TO REDUCE NOISE THE RETURNS OF THE SUPPLIES SHOULD BE CONNECTED TOGETHER.
 - CAUTION: CONFIRM PART NUMBER MATCHES SUPPLY VOLTAGE.

CONNECTION DESCRIPTIONS

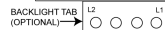
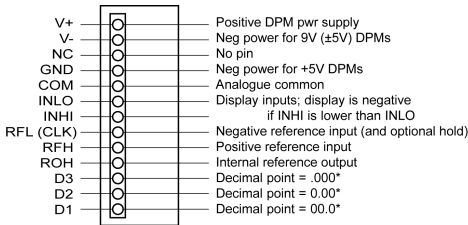

BACKLIGHT POWER CONNECTIONS (OPTIONAL) Solder on front tab.

BACKLIGHT COLOR	SUPPLY CONNECTIONS
RED	L1 POSITIVE (+) L2 NEGATIVE (-)
GREEN	L2 L1

- NOTES:
- Check DPM PIN for correct voltage.
 - The backlight power is separate from the DPM power. To reduce noise, the returns of the supplies should be connected together.

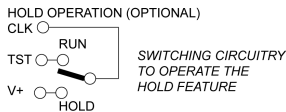

- For 5V operation, connect GND terminal to input low (INLO)
- For 9V operation, connect COM and RFL terminal to input low (INLO)

3.5 DIGIT 13-PIN LCD DPM INSTALLATION SHEET

DPM DIMENSIONS

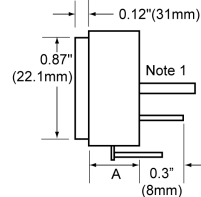

BACKLIT	A Dim.
NO	0.18" (4.6mm)
YES	0.38" (9.7mm)

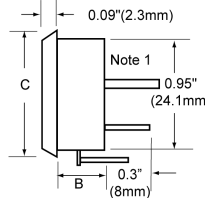

MNTG	BACKLIT	B Dim.	C Dim.
STD. BEZEL	NO	0.33" (8.4 mm)	1.03" (26.2mm)
STD. BEZEL	YES	0.52 (13.2 mm)	1.03" (26.2mm)
SNAPIN BZL	NO	0.45 (11.4 mm)	1.10" (28mm)
SNAPIN BZL	YES	0.33" (8.4 mm)	1.10" (28mm)

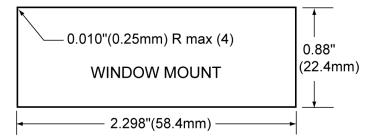
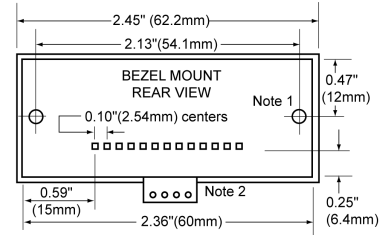
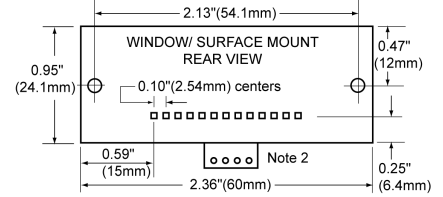

PANEL CUTOUT DIMENSIONS

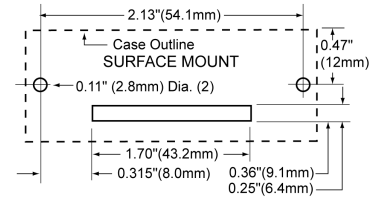

- NOTES:
- Mounting studs (2) are #2-56, length 0.5 (13) min.
 - Backlight Option is on 0.50" (12.4mm) wide X 0.22" (5.4mm) high tab
 - Snap in Bezel Mount does not have mounting studs.

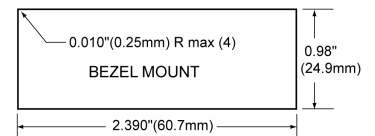

INCHES (mm)