

DIN 72 x 72 mm Counters with Easy-to-use Functions

- Designed with an emphasis on ease of operation.
- All models equipped with prescale function which displays in units of actual physical parameters (length, volume, etc.).
- H7BR-C large/small discrimination mode useful for positioning and production control.
- High-speed response allows 10,000 counts per second.
- High-visibility LCD display with built-in backlight.
- Online change of set value possible.
- Meets UL and CSA standards.
- Conforms to EMC standards.
- Conforms to EN61010-1/IEC1010-1.
- Six-language instruction manual provided.

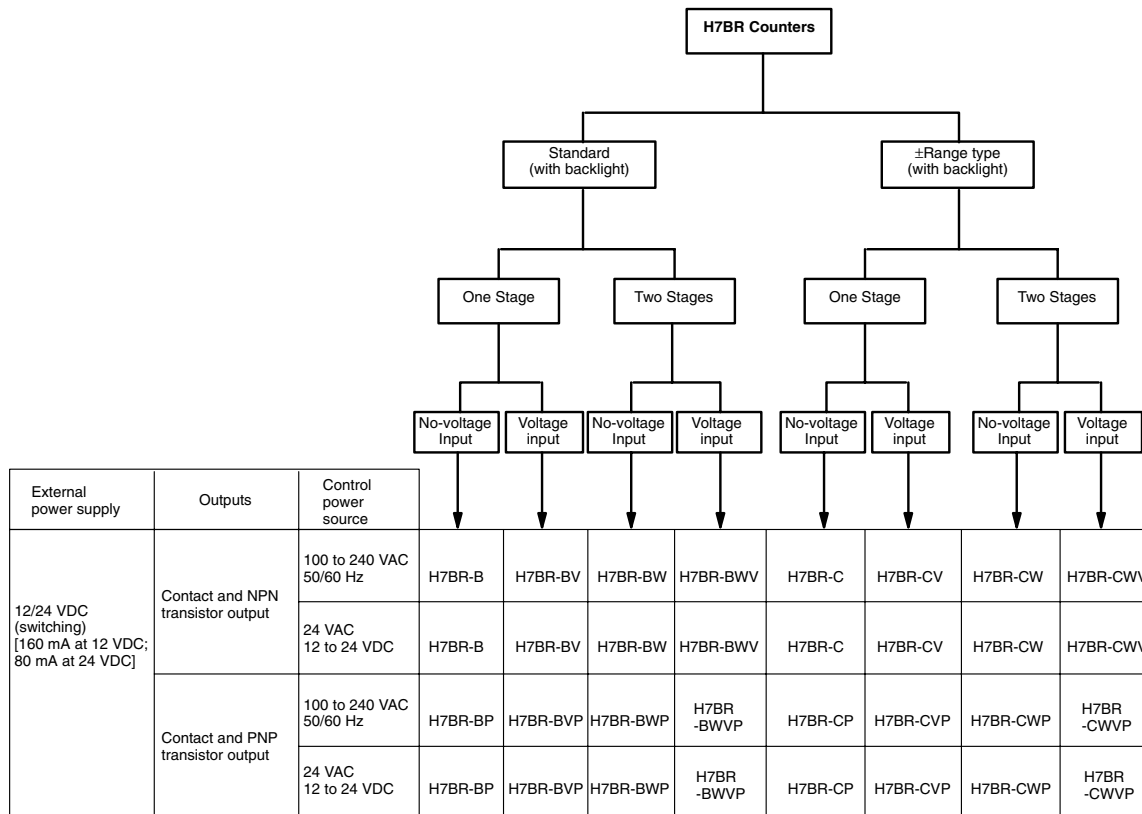

Ordering Information



Note: Specify both the model and control power supply when ordering.
With shock prevention cover types are named "H7BR-□□□□-500."

Model Legend

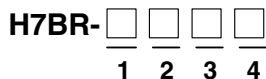

1. Type

B: Standard
C: +/- range

2. Classification

None: 1-stage set counter
W: 2-stage set counter

3. Input Type

None: No-voltage input
V: Voltage input

4. Output Type

None: NPN output
P: PNP output

Accessories (Order Separately)

Soft Cover/Y92A-72F1
Hard Cover/Y92A-72

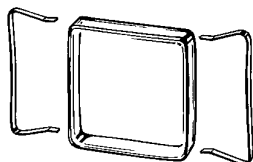

Shock Prevention Cover/Y92A-72T

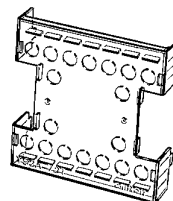

Note: Models with a Shock Prevention Cover can be ordered by adding "-500" to the end of the model number.
e.g., H7BR-B-500 (100 to 240 VAC, 50/60 Hz)

Specifications

Model	H7BR-B (Standard type)	H7BR-C (\pm Range type)
Classification	Digital preset counter	
Mounting method	Flush mounting	
External connections	Screw terminals	
Enclosure ratings	IP54 (panel surface)	
Approved standards	UL508, CSA C22.2 No.14, conforms to EN61010-1/IEC61010-1, EN50081-2, and EN50082-2	
Input modes*	Up (Incrementing), Down (decrementing), and reversible Up/Down A (command inputs), Up/Down B (individual inputs), Up/Down C (quadrature inputs)	Reversible Up/Down A (command inputs), Up/Down B (individual inputs), Up/Down C (quadrature inputs)
Output modes*	N, F, C, R, K, P, Q, A	K, D, L, H
Reset system	External, manual and automatic resets (internal according to C, R, P, AND Q mode operation)	External and manual resets
Prescaling function	Yes (0.001 to 99.999)	
Decimal point adjustment	Yes (Rightmost 3 digits)	
Teaching function	---	Yes
Batch counting function	Yes	---
Set compensation	---	Yes
Gate input	Yes	
Sensor power supply	12 VDC/24 VDC (switching)	
Input signals	Count, reset, key protection, and gate inputs	
	Batch count reset input	Compensation input
Input method	No-voltage input: Via opening and closing of contact Voltage input: Via high and low signal voltage (key protection is no-voltage input)	
Control outputs	1 stage model: SPST-NO contact and transistor (NPN or PNP open collector) output 2 stage model: 2 stages of SPST-NO contact and transistor (NPN or PNP open collector) output Transistor output can be changed by switch. (Except for batch count output.)	
Batch outputs	Transistor output (NPN or PNP open collector)	---
Display	LCD with backlight	
Digits	6 digits (0 to 999,999)	\pm 6 digits (-999,999 to 999,999)
Memory backup	Backup time for power interruption: Approx. 10 years at 20°C (lithium battery)	

■ Ratings

Rated supply voltage	100 to 240 VAC, 50/60 Hz 24 VAC/12 to 24 VDC (contains 20% ripple max.)
Operating voltage range	85% to 110% of rated voltage
Current consumption	Approx. 10 VA at 50 Hz, 240 VAC; approx. 6 W at 24 VDC *
Max. counting speeds (CP1, CP2)	30/1k/5k/10 kcps (separate setting for CP1 and CP2)
Compensation and gate input	Set to the faster of the CP1 and CP2 max. counting speeds
Reset	Min. pulse width for external reset: 1 or 20 ms, also manual reset
Batch count reset	Min. pulse width: Approx. 20 ms
Key protection	Response time: 1 s
One-shot time	10, 50, 100, 200, 500, and 1,000 ms (separate setting for stages 1 and 2)
Count, compensation, reset, batch count reset, and gate inputs	No-voltage input ON impedance: 1 k Ω max. (Approx. 2 mA when 0 k Ω) ON residual voltage: 2 V max. OFF impedance: 100 k Ω max. Voltage input (input resistance: approx. 4.7 k Ω) High level: 4.5 to 30 VDC Low level: 0 to 2 VDC
Key protection input	No-voltage input ON impedance: 1 k Ω max. (Approx. 2 mA when 0 k Ω) ON residual voltage: 1 V max. OFF impedance: 100 k Ω min.
Control outputs	Contacts: 3 A at 250 VAC, resistive load (cos ϕ = 1) Transistor output: Open collector 100mA at 30 VDC max. residual voltage 2 V max. (Approx. 1 V)
External power supply	160 mA, 12 VDC \pm 10% (5% ripple max.) 80 mA, 24 VDC \pm 10% (5% ripple max.)

*When power is turned ON, approx. 8 A inrush current flows for about 2 ms. (24 VDC, 240 VAC)

■ Characteristics

Insulation resistance	100 M Ω min. (at 500 VDC) (between current-carrying terminal and exposed non-current-carrying metal parts, and between non-continuous contacts)
Dielectric strength	2,000 VAC, 50/60 Hz for 1 min (between current-carrying terminal and exposed non-current-carrying metal parts)
Impulse withstand voltage	3 kV (between power terminals) for 100 to 240 VAC type, 1 kV for 24 VAC/12 to 24 VDC 4.5 kV (between current-carrying terminal and exposed non-current-carrying metal parts for 100 to 240 VAC type, 1.5 kV for 24 VAC/12 to 24 VDC.
Noise immunity	\pm 2 kV (between power terminals) and \pm 600 V (between input terminals), square-wave noise by noise simulator (pulse width: 100 ns/1 μ s, 1-ns rise)
Static immunity	Malfunction: 8 kV; destruction: 15 kV
Vibration resistance	10 to 55 Hz with 0.75-mm single amplitude each in three directions 10 to 55 Hz with 0.5-mm single amplitude each in three directions
Shock resistance	300 m/s ² (Approx. 30G) each in three directions 100 m/s ² (Approx. 10G) each in three directions
Life expectancy	10 million operations min. 100,000 operations min. 5 A at 250 VAC in load resistance)
Weight	Approx. 270 g
Ambient temperature	Operating: -10°C to 55°C (with no icing) Storage: -25°C to 65°C (with no icing)
Ambient humidity	Operating: 35% to 85%
EMC	(EMI): EN50081-2 Emission Enclosure: EN55011 Group 1 class A Emission AC Mains: EN55011 Group 1 class A (EMS): EN50082-2 Immunity ESD: EN61000-4-2: 4 kV contact discharge 8 kV air discharge Immunity RF-interference: ENV50140: 10 V/m (Amplitude-modulated, 80 MHz to 1 GHz) 10 V/m (Pulse-modulated, 900 MHz) Immunity Conducted Disturbance: ENV50141: 10 V (0.15 to 80 MHz) Immunity Burst: EN61000-4-4: 2 kV power-line 2 kV I/O signal-line
Case color	Light gray (Munsell 5Y7/1)

■ Block Diagram

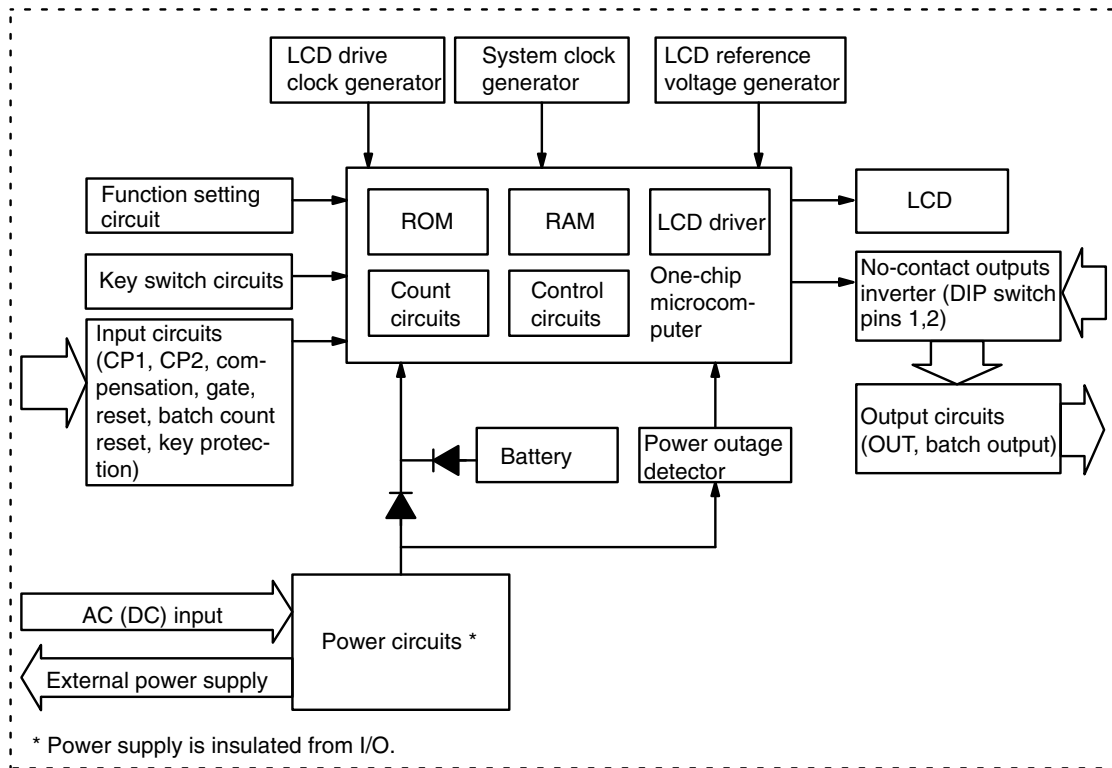

■ I/O Functions

Inputs	CP1/CP2	Count signal inputs. Up, Down, and Up/Down (command, individual, or quadrature) inputs accepted.
	Reset	Resets present value. (to zero in Up modes, to preset with 1-stage models in Down mode, and to preset with 2-stage models.) Count inputs are not accepted while reset input is ON. Reset indicator lit while reset input is ON.
	Compensation input (±Range type)	On rising edge of up count signal, present count is reset to compensation value and, therefore, count inputs are accepted even if the compensation input is set to ON (not effective for down count signals.)
	Batch count reset (Standard type)	Resets batch count to zero and batch output turns OFF. Signals are taken in on the ON edge. Batch count signals are not accepted while batch count reset is ON.
	Key protection	Makes keys inoperative according to key protection level. Key protection indicator lit while key protection input is ON. Effective when power supply is turned off. Effective when protect terminals are shorted.
	Gate	Inhibits counter operation when gate input is ON.
Outputs	OUT 1.2	Outputs made according to designated output mode when corresponding preset is reached. Outputs inhibit on the teaching mode.
	Batch output (Standard type)	Outputs made when batch counter is up to preset number of batches. Batch output remains ON until batch count reset goes ON. When the number of batches is set to zero, batch counting is performed but batch outputs are not made. Batch counter counts the number of completed counts to the preset for 1-stage models and to preset 2 for 2-stage models.

Engineering Data

Life Expectancy of Contacts

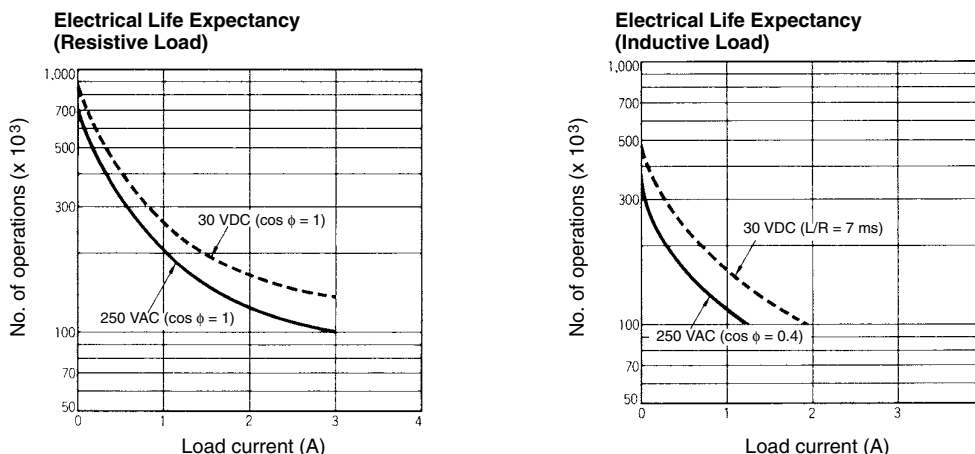

Reference: A current of 0.15 A max. can be switched at 125 VDC (cos φ = 1) and a current of 0.1 A max. can be switched if L/R = 7 ms. In both cases, a life of 100,000 operations can be expected.

Nomenclature

Front View

Indicator

- Power indicator
- Key protection indicator
- Control output indicator
OUT: 1 stage
OUT1, OUT2: 2 stages
- Batch output indicator (H7BR-B only)
- Present value (character height: 12 mm) (Zeroes suppressed)
- Set value (character height: 8 mm) (Indicates data in function setting mode)
- Set value 1,2 stage indicator.
- Batch indicator (Displays batch count indicator.)

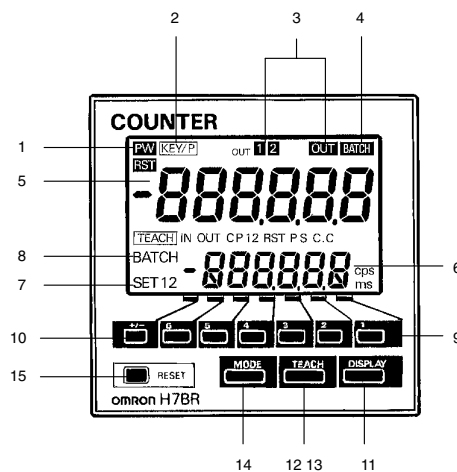

Operation Key

- Increment Keys (1 to 6) (Used to change the corresponding digit of the set value. Used to change data in the function setting mode.)
- Code Key (H7BR-C type only) (Changes ±code of setting value.)
- Display Key (Switches to the batch count, teaching mode, setting displays. For 2 stage model, switch set value 1,2.)
- Batch Key (H7BR-B type only) (Switches to the batch display.)
- Teaching Key (H7BR-C type only) (Switches to the teaching mode.)
- Mode Key (Switches from run mode to function setting mode. Changes items in the function setting mode.)
- Reset Key (Resets present value and outputs.)

■ Side View

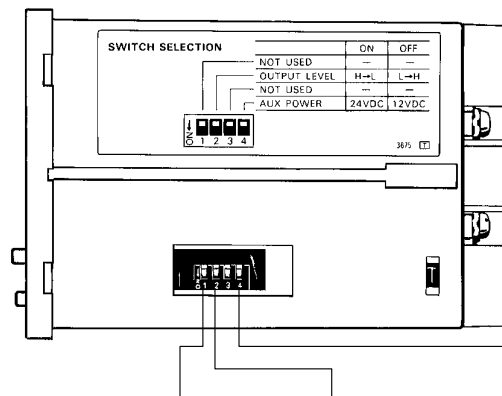

Dip switch

Models		Switch No.	1	2	3	4
			Operation of each transistor output when count up		Invalid	External power supply
One-stage	OFF	---	---	Output OFF to ON	---	12 VDC
	ON	---	---	Output ON to OFF	---	24 VDC
Two-stage	OFF	Output 1 OFF to ON	Output 2 OFF to ON	---	---	12 VDC
	ON	Output 1 ON to OFF	Output 2 ON to OFF	---	---	24 VDC

Note: All DIP Switches are set to OFF at the factory.

Operation

■ Factory Settings

The following table shows the counter settings when it is shipped. Please change the settings as necessary to suit the system before operation. Settings and the display receive power from the internal battery and are therefore unaffected by external power interruptions.

Model	H7BR-B	H7BR-C
Present value	0	0
Presets	0	0
Batch present count	0	---
Batch setting count	0	---
Input mode	Up	Up/Down C (quadrature)
Output mode	N	K
Output 2 time	(Hold)	1,000 ms
Output 1 time (2-stage only)	Hold	1,000 ms
CP1 and CP2 counting speeds	30 cps	30 cps
Min. reset time	20 ms	20 ms
Decimal point	Far right (no fractions)	Far right (no fractions)
Prescale	1,000	1,000
Compensation count value	---	0
Key protection level	KP-1	KP-1

Note: With the initial settings, there will be no output even if the power supply is connected. External inputs and outputs cannot be used without a power supply.

■ Operational Overview

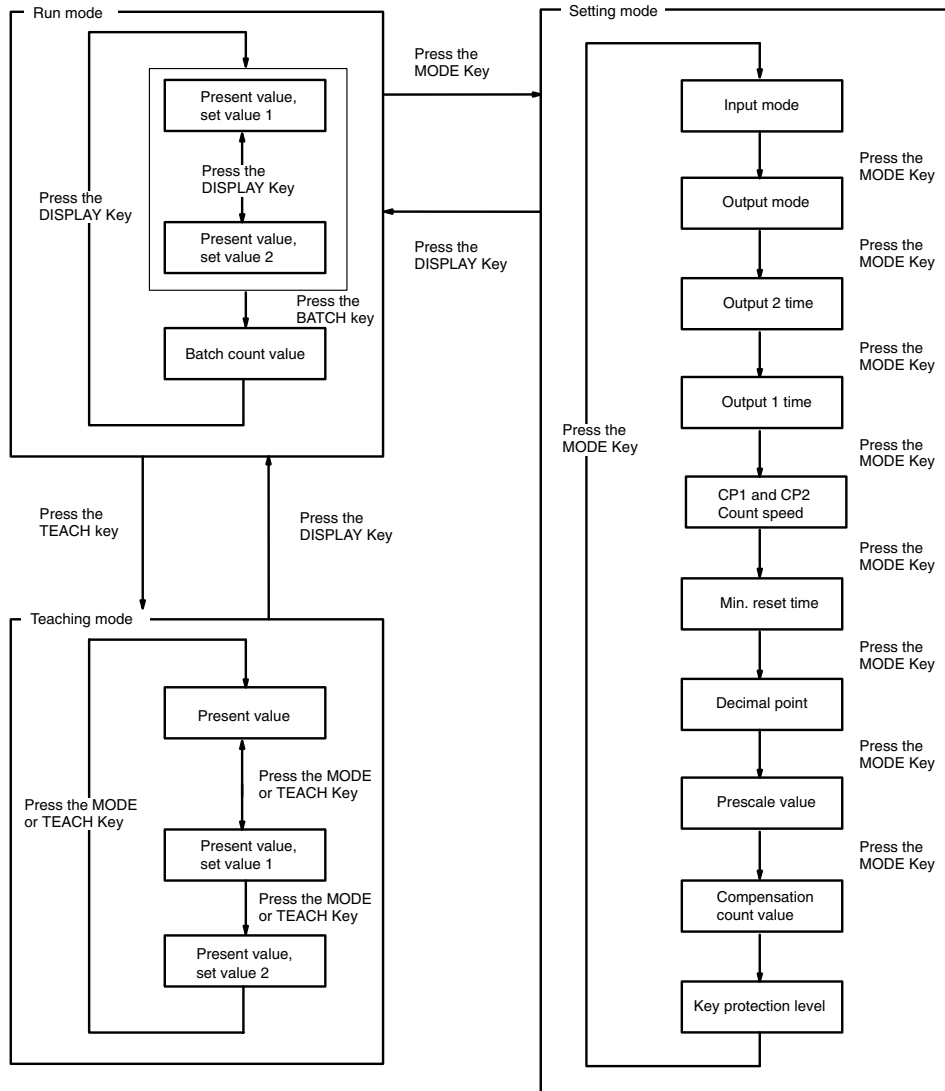

Note: Set values are changed with the Increment Keys (1 to 6).

■ Setting Item Table

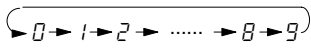
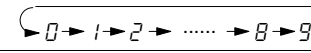
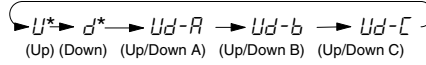
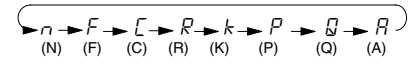
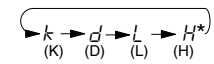
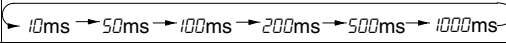
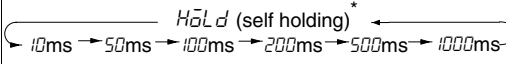
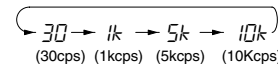
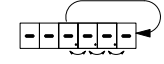
Mode	Setting item (Display)	Applicable model		Description	Setting procedure
		H7BR-B□	H7BR-C□		
Run mode	Set value 1 (SET1) ↕ Set value 2 (SET2)	Yes	Yes	Compared to the present value, determines the timing of the control output according to the output mode. The DISPLAY Key switches between set values 1 and 2. (2-stage model only.)	Sequence when changing a digit using the Keys (1 to 6).  Press the Code Key (+/-) to change the plus or minus sign of the set value if the model is the H7BR-C. (+) (blank) ↔ - (-)
	Batch count set value	Yes	No	Batch output is turned ON when the set number of times is counted.	Sequence when changing a digit using the Keys (1 to 6). 
Function setting mode	Input mode (IN)	Yes	Yes	Determines the input mode selecting from Up, Down, Up/Down modes.	Press keys 1 to 6 to change the mode.  (Up) (Down) (Up/Down A) (Up/Down B) (Up/Down C) *H7BR-B only.
	Output mode (OUT)	Yes	Yes	Determines the form of the control output. (Refer to the present value vs. output diagrams on pages 15 to 18.) Determines the output time for control output (Output 2).	Press keys 1 to 6 to change the mode. H7BR-B  (N) (F) (C) (R) (K) (P) (Q) (A) H7BR-C  (K) (D) (L) (H) *2-stage model only. Press keys 1 to 6 to change the Output 2 time. (Applicable to output modes C, R, K, P, Q, and A-only.) 
	Output time 1 (2-stage model only) (OUT)	Yes	Yes	Determines the output time of the control output (OUT 1) for 2-stage model counters.	Press keys 1 to 6 to change the set value.  <i>HOLD</i> (self holding)* *H7BR-BW only.
	CP1 and CP2 Count speed (CP1, CP2)	Yes	Yes	Switches the count input filter to protect against errant counts due to interference.	Press keys 1 to 6 to change the set value.  (30cps) (1kcps) (5kcps) (10kcps) • The response speeds of the gate input and compensation input are both set to the count speed of CP1 or CP2, whichever is faster. • The CP1 and CP2 count speed must be set to the same value only when the H7BR is in Up/Down C input mode.
Min. reset time (RST)	Yes	Yes	Determines the initial signal width of the external reset.	Press keys 1 to 6 to change the set value. (1 ms) ↔ 20 (20 ms)	
Decimal point (-----)	Yes	Yes	Determines the decimal point position of the present and set values.	Move the decimal point position with keys, 1 to 6. 	

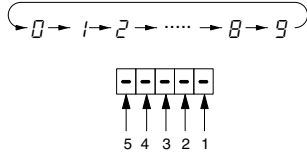
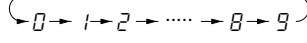
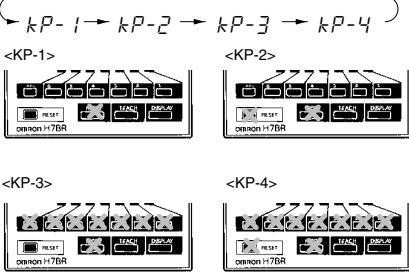
Mode	Setting item (Display)	Applicable model		Description	Setting procedure
		H7BR-B□	H7BR-C□		
Function setting mode	Prescale value (PS)	Yes	Yes	Can calculate and display a physical parameter (volume, length, etc.) from the present value. For example, if one count input represented a movement of 0.02 mm, the prescale value would be 0.02. Values from 0.001 to 99.999 are possible.	Change the value of the digits with the corresponding keys, 1 to 5. 
	Compensation count value (C.C)	No	Yes	Use compensation input to change the count value to set value.	Change the value of the digits with the corresponding keys, 1 to 6.  Press the Code Key to change the plus or minus sign of the set value. (+) (blank) ← → - (-)
	Key protection level	Yes	Yes	Locks certain keys to prevent accidental operation. The key protection level, kP-1 to kP-4, determines which keys are locked when the key protection input is ON. The locked keys are crossed out in the diagram on the right.	Sequence when changing the key protection level using the Increment Keys (1 to 6). 
Teaching Mode	Prescale value (PS)	No	Yes	---	By setting the conversion count value and pressing the TEACH Key, the prescale value is automatically calculated and set.
	Set value 1 (two-stage model only) (SET1)	No	Yes	---	By pressing the TEACH Key, the Present value is set as the set value.
	Set value 2 (SET2)	No	Yes	---	

- Note:**
- Settings changed in setting mode are not effective until run mode is entered.
 - Control output is prohibited in teaching mode. Output is OFF in coincidence-ON operation and ON in coincidence-OFF operation.
 - The TEACH Key is disabled when the H7BR is turned OFF, when no teaching is possible. Other functions are enabled regardless of whether the H7BR is turned ON or OFF.

Examples

Run Mode

Changing the Set Value

1. Press the DISPLAY Key to change the displayed preset value 1 and 2 during operation.

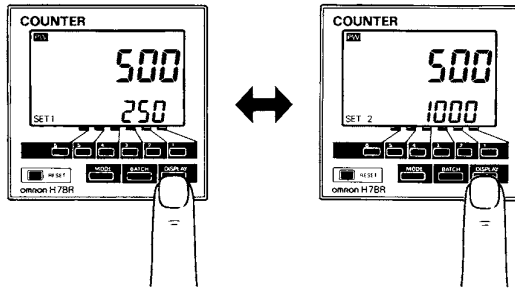

2. Change the set value from 250 to 1,250.

- Pressing keys 1 through 6 increments the corresponding column by 1.
- Non-significant zeros are normally not shown on the set value display.

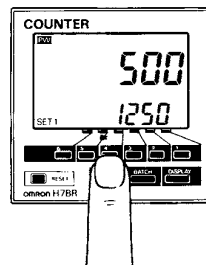

Batch Set Value Change (Applicable to Standard Models Only)

1. Selecting Batch Count Display
Switch the count display over to batch count display.
Press the BATCH Key.

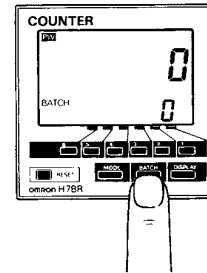

2. Batch Set Value Change

Change the batch set value while the batch count is displayed. Pressing keys 1 through 6 increments the corresponding column by 1.

- Non-significant zeros are normally not shown on the set value display.
In order to switch the batch count display over to the count display, press the DISPLAY Key.

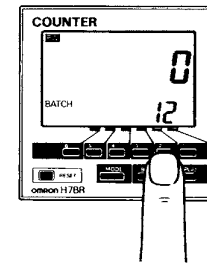

Setting Mode

Changing Settings in the Function Setting Mode

1. Press the MODE Key to switch from run mode to setting mode.
 - The Counter will continue operation if switched from run mode to function setting mode during operation.
 - The MODE Key will be locked if the key protection function is enabled.
 - Settings changed in the function setting mode are not effective until run mode is entered. As the operating conditions will change in this case, always reset operation with the RESET Key or a reset input.

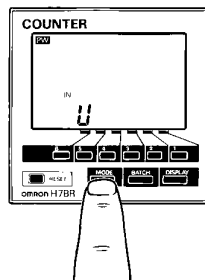

2. Press the MODE Key to scroll successively through the items that can be set. Release the MODE Key to select the desired item.

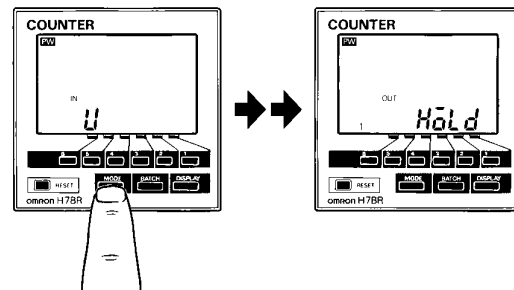

3. Changing the selected item

- Press the MODE Key until the desired item appears
- Change the item setting by pressing keys 1 through 6. (Press the DISPLAY Key to switch back from function setting mode to run mode.)

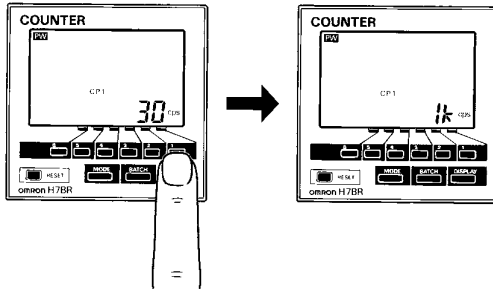

- Press the DISPLAY Key to return to Run mode from Setting mode.

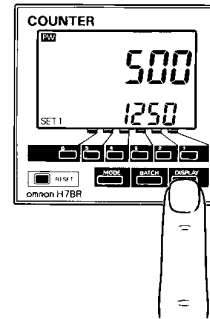

Teaching Mode (\pm Range Models Only)

Changing to Teaching Mode (Power Must be ON)

Change from run mode to teaching mode.

Press the TEACH Key.

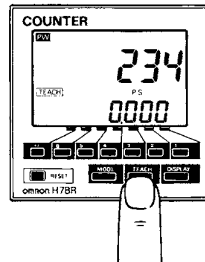

If prescale teaching is not required, press the MODE Key and go to *Set Value 1 Teaching*.

Prescale Teaching

1. Perform prescale teaching of the H7BR in teaching mode.
 - The prescale display shows 0.000.

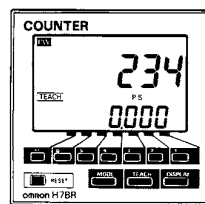

2. Set 10 cm as a converted count value, for example. Pressing keys 1 through 6 increments the corresponding column by 1.
 - By pressing one of keys 1 through 6, the counter PV (present value) display indicates 0.

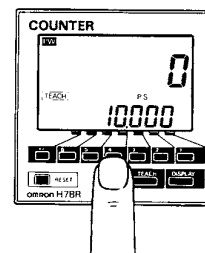

3. Input a count signal corresponding to the conversion count value through the external sensor.
 - The display on the right side indicates that an input of 50 counts has been input from the external sensor with the controlled object moved 10 cm.

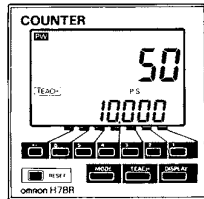

4. Perform prescale value teaching per count.
Press the TEACH Key. (Prescale value $0.2 = 10 \text{ cm}/50$)

- If the conversion count value input at step 3 is a negative value, the prescale value will be calculated using the absolute value of the conversion count value.
- The fraction is rounded off for prescale calculations. (It is rounded upward when displaying negative values.)
- While the TEACH Key is pressed, the teaching prescale value (i.e., 0.2) is displayed.

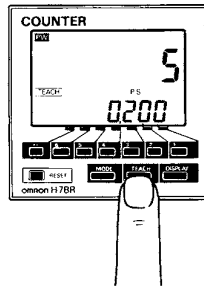

Set Value 1 Teaching

1. Press the MODE Key to perform the teaching of set value 1, provided that the H7BR is a two-stage model.
 2. Input an appropriate count signal from the external sensor.
 3. Register the count value 250 as the set value, for example. Press the TEACH Key.
- The teaching set value is displayed while the TEACH Key is pressed.

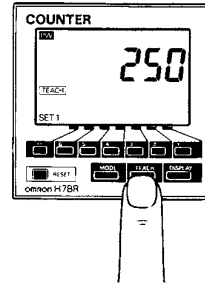

Set Value 2 Teaching (Two-stage Models Only)

- Perform the same procedure as *Set Value 1 Teaching* above. Press the DISPLAY Key to return to run mode from teaching mode.

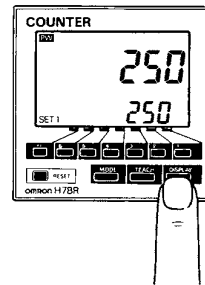

■ Input Modes and Count Value

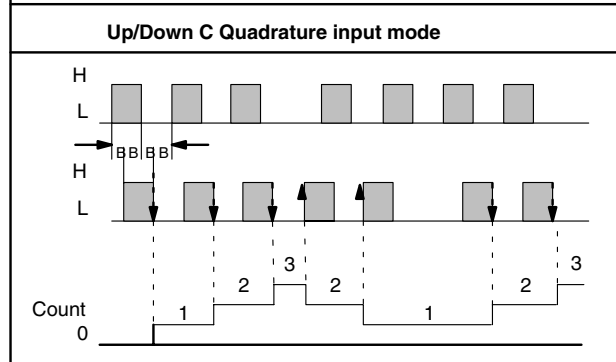
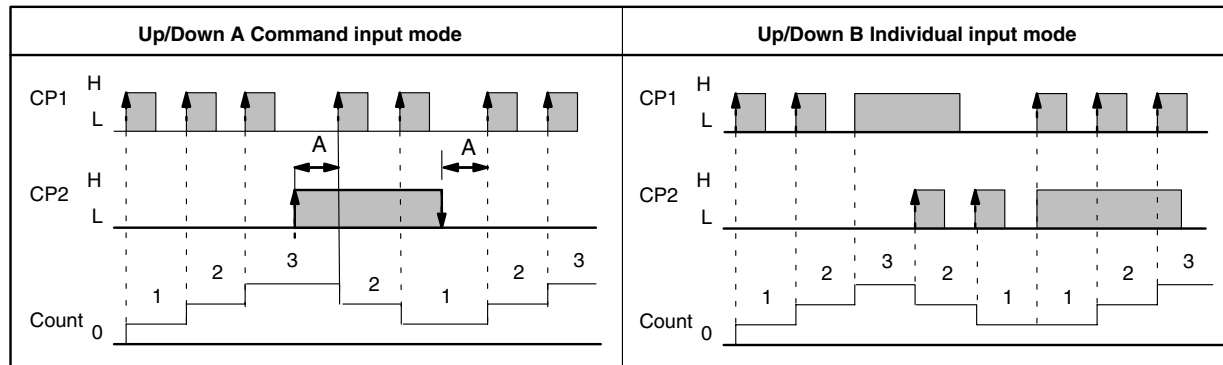
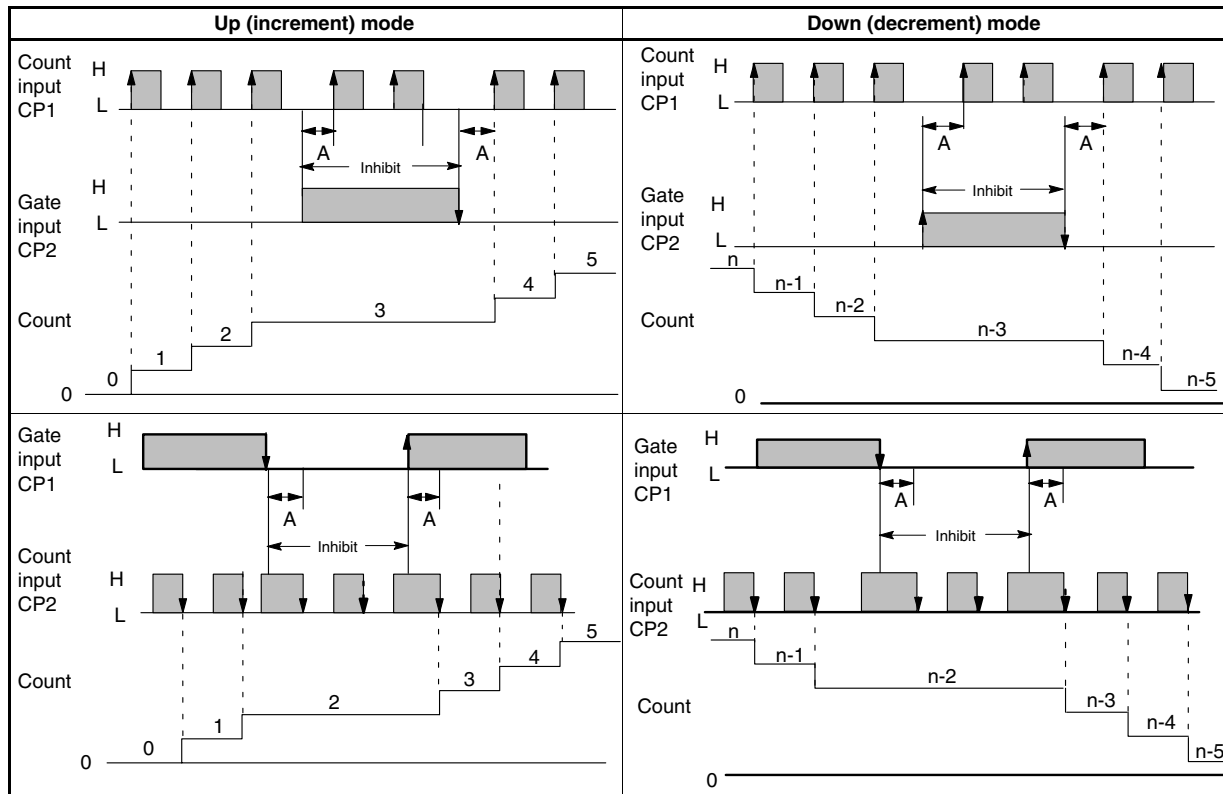

- Note 1 A: Minimum signal width; B: Must be at least 1/2 of minimum signal width. Signals may not be counted if the minimums for A and B are not met.
- Note 2 Set the same counting speed for CP1 and CP2 when in Up/Down C mode.
- Note 3 H and L

Signal	No-voltage input	Voltage input
H	Short-circuit	4.5 to 30 VDC
L	Open circuit	0 to 2 VDC

■ Input/Output Mode Setting

H7BR-B

Output 2 operation applies for 1-stage models only.

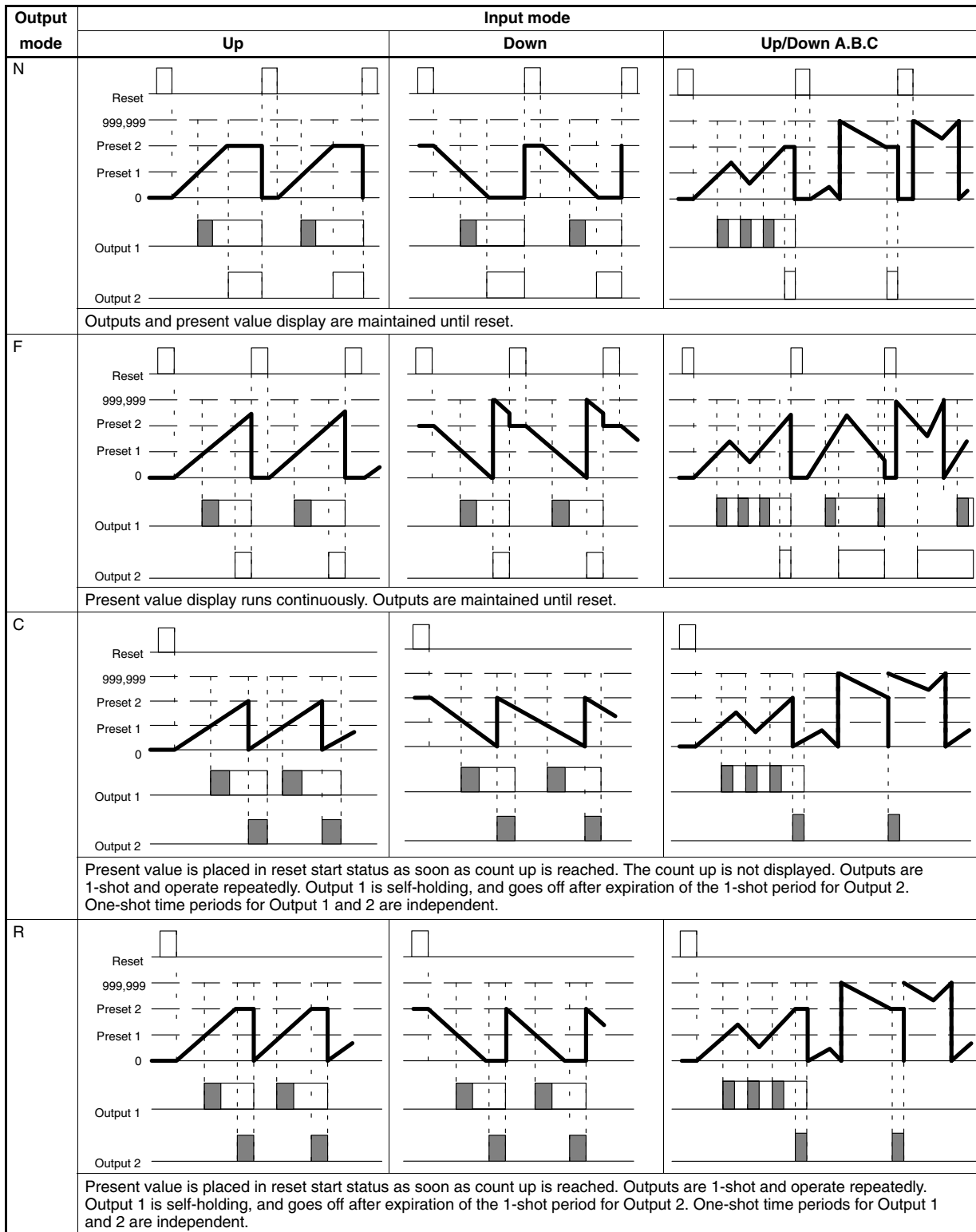

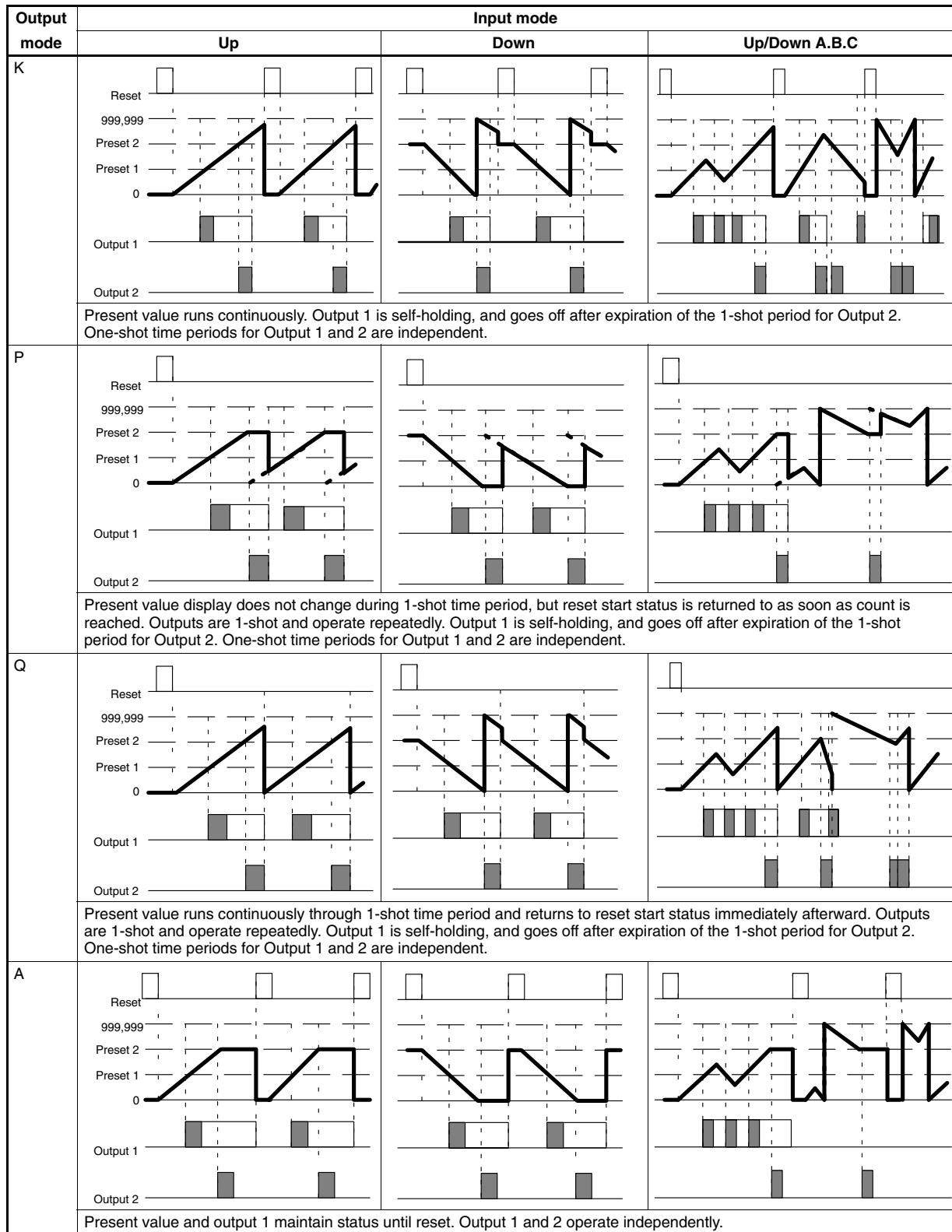

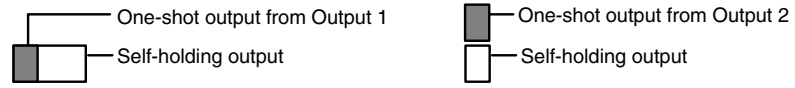

One-shot outputs can be set to between 10 and 1,000 ms.

Batch Counter Operation

The batch counter counts the number of times set value is reached for 1-stage models, and the number of times set 2 is reached for 2-stage models.

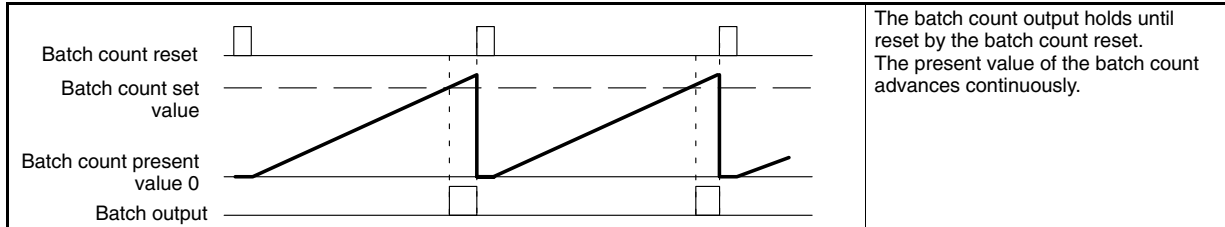

The batch count output holds until reset by the batch count reset. The present value of the batch count advances continuously.

1. The batch count present value remains at 0 while the batch count reset is ON.
2. When the batch count set value is 0, the batch count will proceed, but there will be no output.
3. When the batch count present value exceeds 9999, it returns to 0.
4. The batch count present value and output do not affect the RESET Key or reset input.
5. When power is interrupted and the batch count output is ON, the output will be ON when power returns.
6. When a batch count set value which is greater than the present value is changed to a set value which is less than the present value, the output will go ON.
7. If, after the output has gone ON, the set value is changed to a set value which is greater than the present value, the output will remain ON.

H7BR-C

Output 2 operation applies for 1-stage models only.

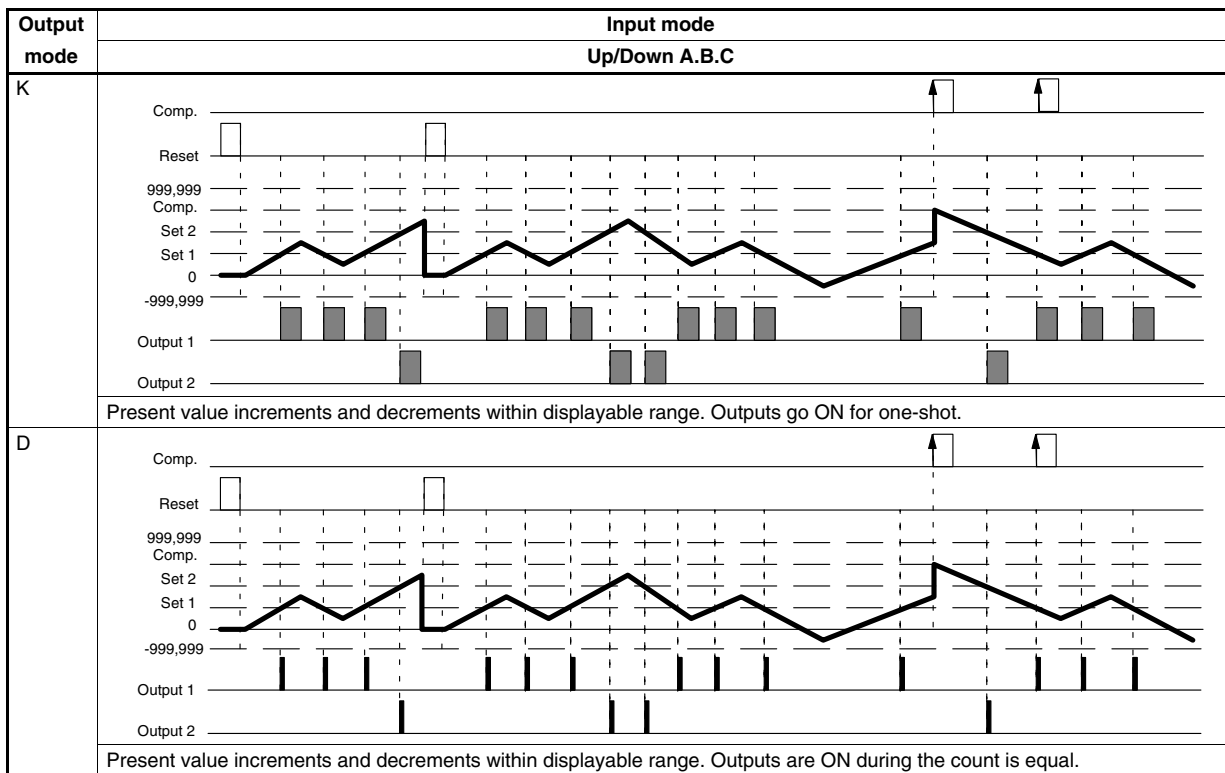

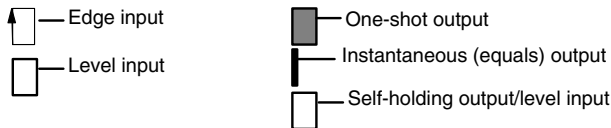
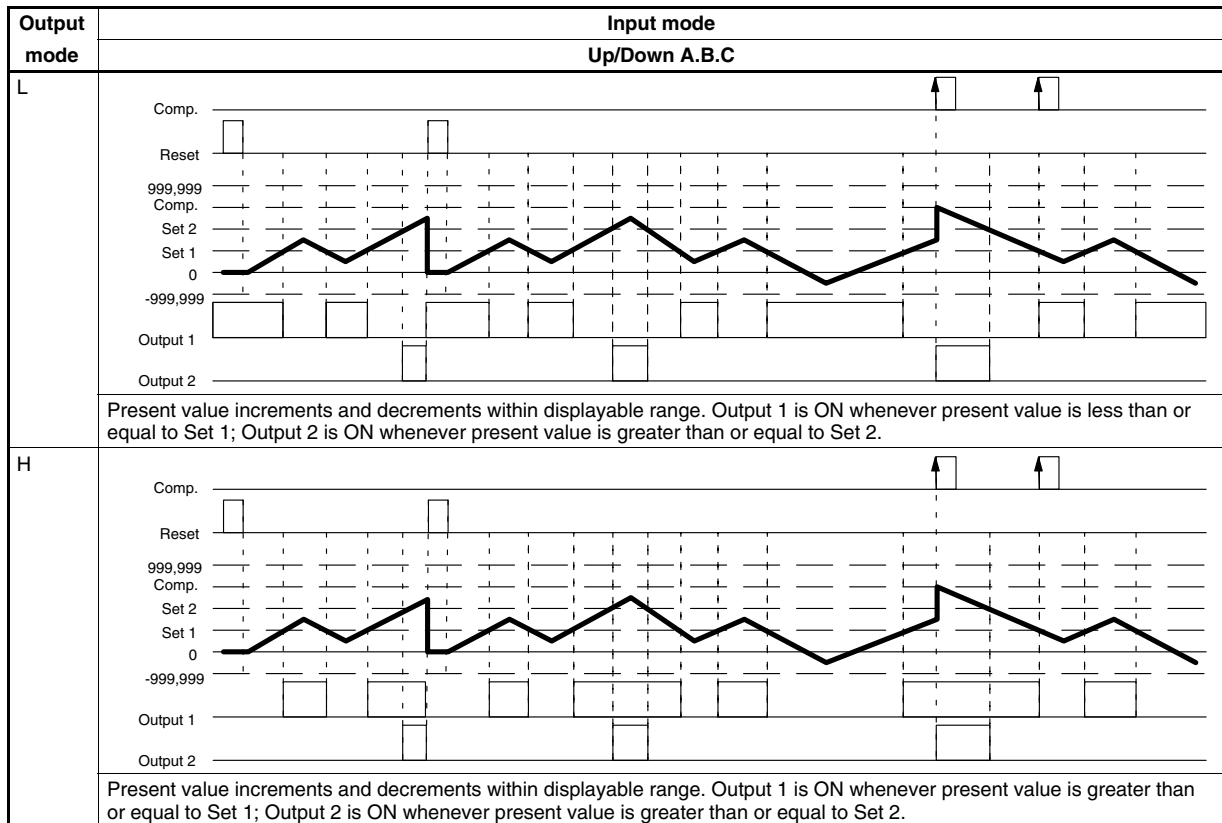

One-shot outputs can be set to between 10 and 1,000 ms.

- Note:**
- Counting inputs are not applied while the reset input is ON.
 - One-shot outputs, when ON, are turned OFF when the reset input goes ON.
 - One-shot outputs, when ON, are left ON for the one-shot time period when the compensation input goes ON.
 - One-shot outputs, when ON, are reset and the one-shot output is restarted if a preset designating the output is reached.
 - The compensation input is valid only when the present value is being incremented. The compensation input is also valid only for the H7BR-C□.

Dimensions

Note: All units are in millimeters unless otherwise indicated.

H7BR

Flash Mounting

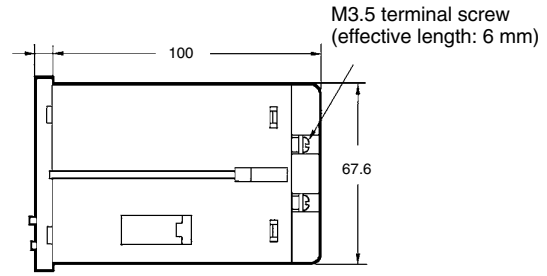
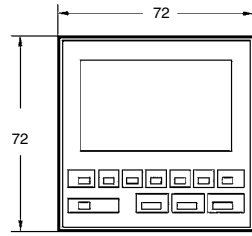
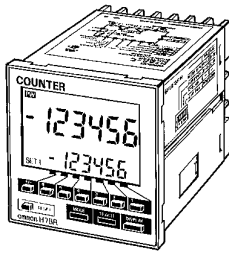

Flash Mounting Adapter

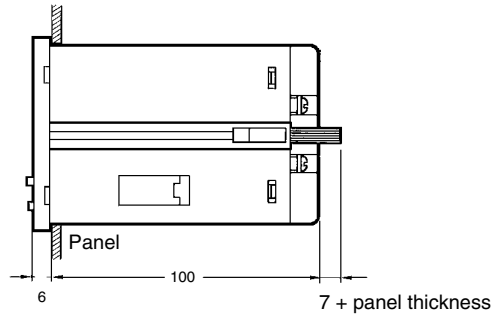
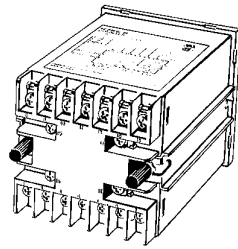
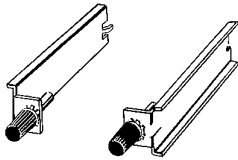

Panel Cutouts

Panel cutouts are as shown at right. (according to DIN43700).

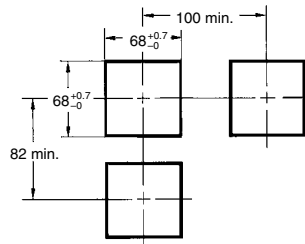

Installation

■ Terminal Arrangement

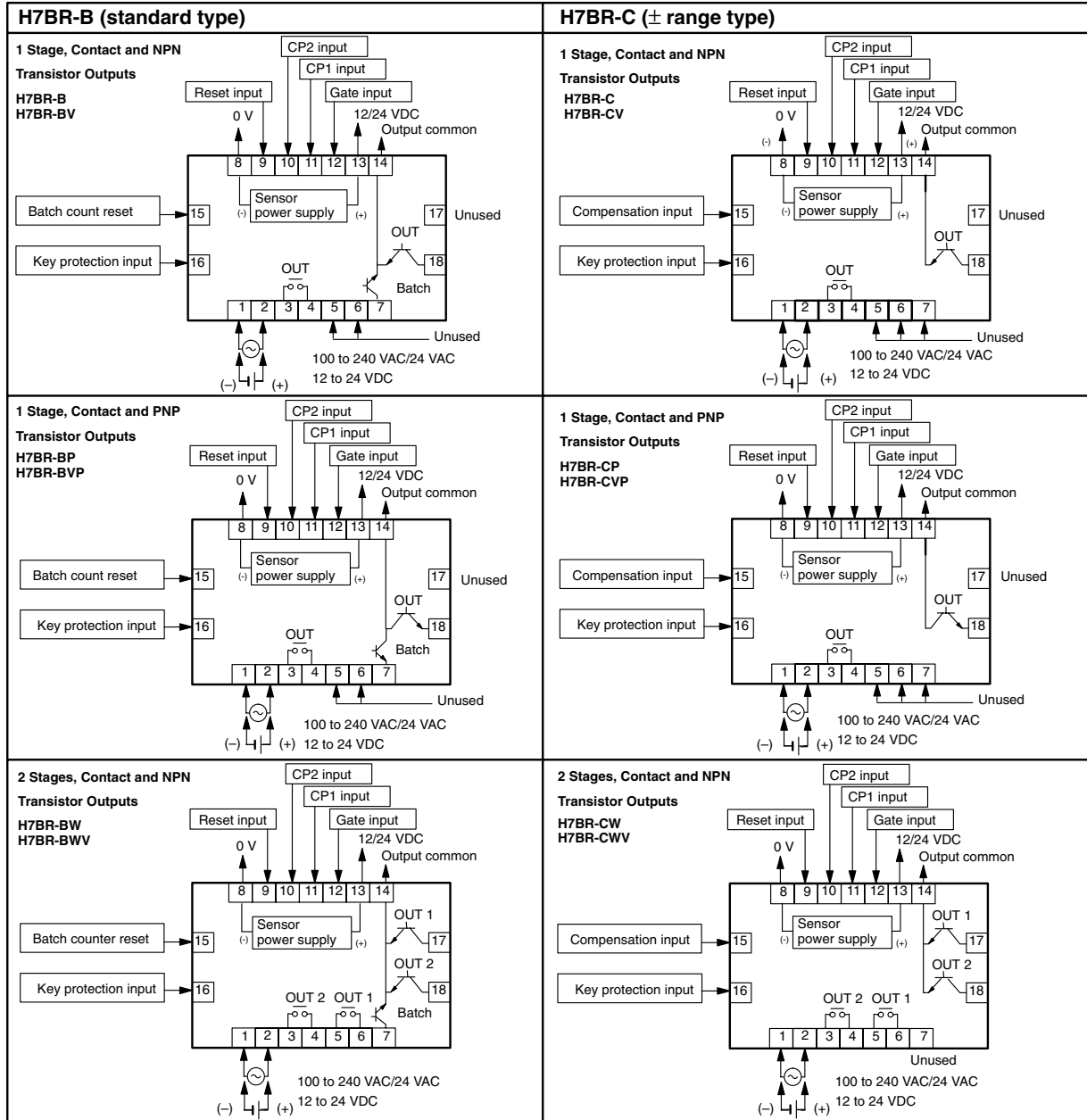

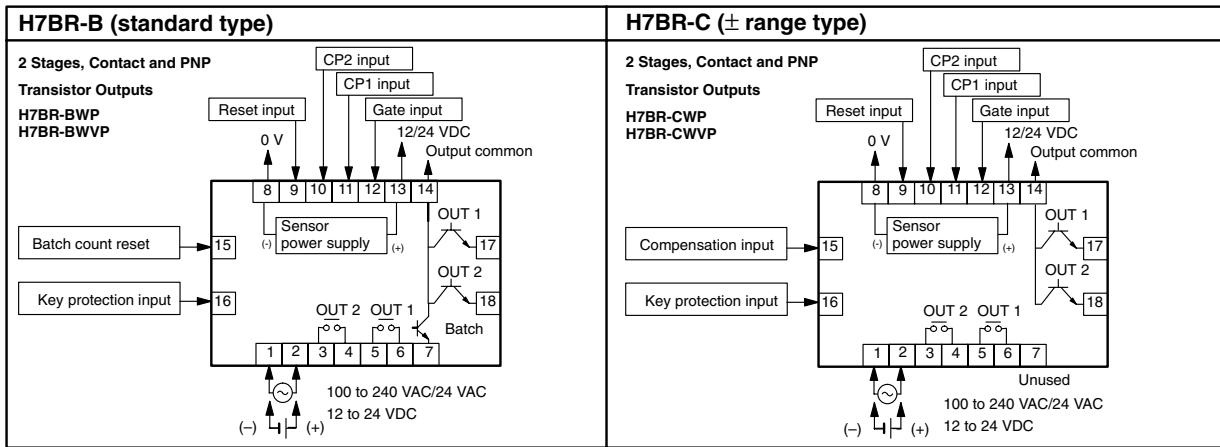

Note: Do not connect unused terminals.

■ Connections

The inputs of the H7BR are no-voltage (short-circuit or open) inputs and voltage inputs. (Key protection only for no-voltage inputs)

No-voltage Inputs

Open Collector

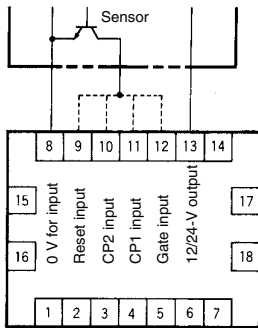

*H: Transistor ON

Voltage Output

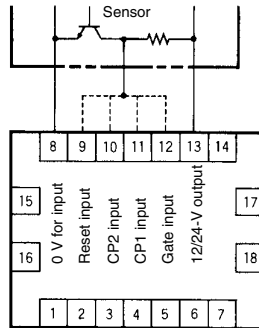

*H: Relay ON

Contact Input

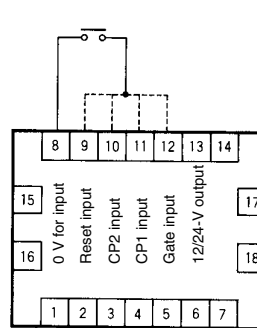

*H: Transistor ON

No-voltage Input Signal Levels

No-contact input	<p>1. High level Transistor ON Residual voltage: 2 V max. Impedance when ON: 1 kΩ max.</p>
	<p>2. Low level Transistor OFF Impedance when OFF: 100 kΩ max.</p>
Contact input	Use contacts which can adequately switch 2 mA at 5 V

Voltage Inputs

NPN Transistor

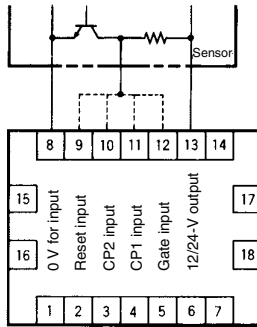

*H: Transistor OFF

PNP Transistor

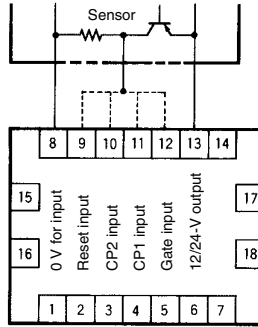

*H: Transistor ON

Contact Input

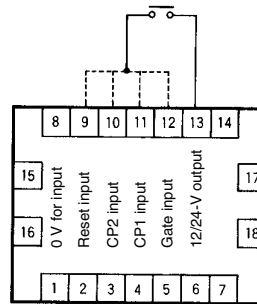

*H: Relay ON

Voltage Input Signal Levels

1. High level 4.5 to 30 VDC
2. Low level 0 to 2 VDC

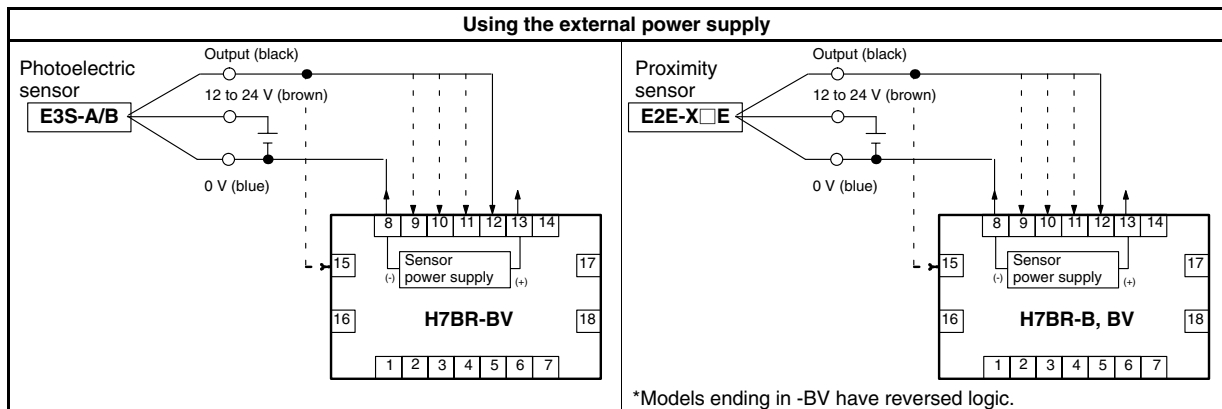
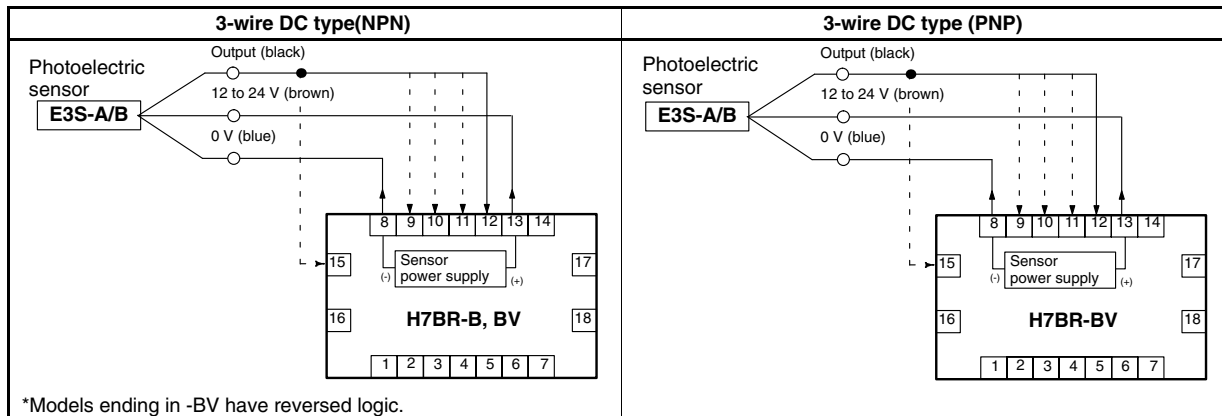

Precautions

■ Sensor Power Supply

- The capacity of the external power supply is 160 mA at 12 VDC/80 mA at 24 VDC switchable. When using a 24 VAC/12 to 24 VDC power supply type H7BR, reduce the load with the power supply voltage, as shown in the following diagram (When supplying external power).

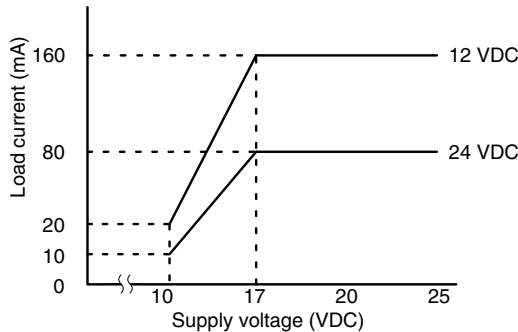

■ Power Supplies

- When turning the power ON and OFF, input signal reception is possible, unstable, or impossible as shown in the diagram below. The unstable period will vary with power supply voltage, and the load conditions on external power supplies.

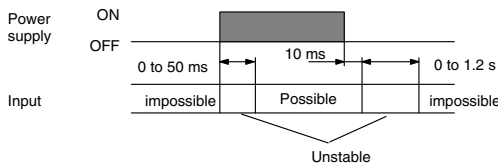

- A switching regulator is used in the internal circuits of counters with 100-to-240-VAC or 12-to-24-VAC specifications, causing an inrush current (approx. 1.5 A) to flow when power is turned on. If the capacity of the power supply to the counter is insufficient, the counter may not start operation. Be sure to provide adequate capacity (recommended supply capacity; 25 W min.)
- Connect the power supply voltage through a relay or switch in such a way that the voltage reaches a fixed value immediately.

■ DIP Switch Setting Changes

Any changes in the DIP switch settings while power is being supplied is invalid. Restart the power supply.

■ Self-diagnostic Function

- The following displays will appear if an error occurs. The present value and output enter the same status as after pressing the RESET Key.

Display	Error	Output status	Correction	Function setting
-----*	Present value below min.	No change	Press RESET Key	No change
FFFFFF**	Present value above max.	No change	or reset input	No change
E1	CPU	OFF	Press RESET Key	No change
E2	Memory	OFF	Press RESET Key	Set at the factory

*Displayed when the present value has fallen below the min. value in the H7BR-C (±range type).

**Displayed when the present value has exceeded the max. value in the H7BR-C (±range type).

■ Operating Environment

- When using the Counter in an area with much electronic noise, separate the Timer, wiring, and the equipment which generates the input signals as far as possible from the noise sources. It is also recommended to shield the input signal wiring to prevent electronic interference.
- Organic solvents (such as paint thinner), as well as very acidic or basic solutions might damage the outer casing of the Counter.

■ Using the Prescale Function

- When setting the prescale value, be sure that the set value satisfies this equation: set value "max. value - prescale value". (if the prescale value is 1,250, 999.999 - 1,250 = 998.749 max.)
- If a higher value is used, the output may be affected, so make sure that the output is produced before starting operation.

■ Changing Set Values

- When changing the set value while the Counter is operating, the output will be produced if the set value ever equals the present value. To avoid triggering the output, begin by incrementing a higher digit to a large number.

■ Resetting with a Set Value of 0

- When resetting is performed with the set value set to "0," no output will be given for the safety reasons once the reset is turned OFF (except for the H7BR-C).

■ Output Delay

- The following table shows the delay from when the present value passes the set value until the output is produced. (The delay is the result of output control time, signal transmission time, relay switching time, etc.)

Actual measurements in N and K modes.

Control output	Max. counting speed	Output delay*
Contact output 1, 2	30 Hz {cps}	18 to 24 ms
	1 kHz {cps}	4.7 to 5.8 ms
	5 kHz {cps}	4.4 to 5.4 ms
	10 kHz {cps}	4.3 to 5.3 ms
Transistor output 1, 2	30 Hz {cps}	13.5 to 20 ms
	1 kHz {cps}	0.59 to 0.81 ms
	5 kHz {cps}	0.29 to 0.44 ms
	10 kHz {cps}	0.24 to 0.36 ms
Batch outputs	30 Hz {cps}	13.6 to 20.2 ms
	1 kHz {cps}	0.72 to 0.94 ms
	5 kHz {cps}	0.42 to 0.57 ms
	10 kHz {cps}	0.37 to 0.49 ms

*The variation in delays is due to different modes and conditions. For systems where the delay is a problem, take actual measurements under operating conditions.

■ Max. Count Speed of Batch Counter

- The maximum count speed of the batch counter is 1 kHz {cps}. The batch counter counts the number of count-up times at the last stage (i.e., the number of preset-value counts if the H7BR is a one-stage model and the number of SET2 preset-value counts if the H7BR is a two-stage model). An interval of 1 ms or more is required before the batch counter counts up again after it has counted up.

■ Response Delay Time for Resetting (Transistor Output)

- Take the following output delays into consideration after the reset signal input is turned ON and the output is turned OFF.

Minimum reset signal width	Output delay time
1 ms	0.8 to 1.2 ms
20 ms	15 to 25 ms

■ Other

- When the Counter is installed in a control box and tests are conducted which may damage the Counter's internal circuitry (for example, a test measuring the maximum voltage difference between the control circuit and metal components), remove the Counter from the control box or short-circuit the terminals.

ALL DIMENSIONS SHOWN ARE IN MILLIMETERS.

To convert millimeters into inches, multiply by 0.03937. To convert grams into ounces, multiply by 0.03527.

Cat. No. M009-E1-01D In the interest of product improvement, specifications are subject to change without notice.

OMRON Corporation
Industrial Automation Company

Industrial Control Components Division
Shiokoji Horikawa, Shimogyo-ku,
Kyoto, 600-8530 Japan
Tel: (81)75-344-7119/Fax: (81)75-344-7149

Printed in Japan
0103-0.5C (1190)

Read and Understand This Catalog

Please read and understand this catalog before purchasing the products. Please consult your OMRON representative if you have any questions or comments.

Warranty and Limitations of Liability

WARRANTY

OMRON's exclusive warranty is that the products are free from defects in materials and workmanship for a period of one year (or other period if specified) from date of sale by OMRON.

OMRON MAKES NO WARRANTY OR REPRESENTATION, EXPRESS OR IMPLIED, REGARDING NON-INFRINGEMENT, MERCHANTABILITY, OR FITNESS FOR PARTICULAR PURPOSE OF THE PRODUCTS. ANY BUYER OR USER ACKNOWLEDGES THAT THE BUYER OR USER ALONE HAS DETERMINED THAT THE PRODUCTS WILL SUITABLY MEET THE REQUIREMENTS OF THEIR INTENDED USE. OMRON DISCLAIMS ALL OTHER WARRANTIES, EXPRESS OR IMPLIED.

LIMITATIONS OF LIABILITY

OMRON SHALL NOT BE RESPONSIBLE FOR SPECIAL, INDIRECT, OR CONSEQUENTIAL DAMAGES, LOSS OF PROFITS, OR COMMERCIAL LOSS IN ANY WAY CONNECTED WITH THE PRODUCTS, WHETHER SUCH CLAIM IS BASED ON CONTRACT, WARRANTY, NEGLIGENCE, OR STRICT LIABILITY.

In no event shall responsibility of OMRON for any act exceed the individual price of the product on which liability is asserted.

IN NO EVENT SHALL OMRON BE RESPONSIBLE FOR WARRANTY, REPAIR, OR OTHER CLAIMS REGARDING THE PRODUCTS UNLESS OMRON'S ANALYSIS CONFIRMS THAT THE PRODUCTS WERE PROPERLY HANDLED, STORED, INSTALLED, AND MAINTAINED AND NOT SUBJECT TO CONTAMINATION, ABUSE, MISUSE, OR INAPPROPRIATE MODIFICATION OR REPAIR.

Application Considerations

SUITABILITY FOR USE

OMRON shall not be responsible for conformity with any standards, codes, or regulations that apply to the combination of products in the customer's application or use of the product.

At the customer's request, OMRON will provide applicable third party certification documents identifying ratings and limitations of use that apply to the products. This information by itself is not sufficient for a complete determination of the suitability of the products in combination with the end product, machine, system, or other application or use.

The following are some examples of applications for which particular attention must be given. This is not intended to be an exhaustive list of all possible uses of the products, nor is it intended to imply that the uses listed may be suitable for the products:

- Outdoor use, uses involving potential chemical contamination or electrical interference, or conditions or uses not described in this catalog.
- Nuclear energy control systems, combustion systems, railroad systems, aviation systems, medical equipment, amusement machines, vehicles, safety equipment, and installations subject to separate industry or government regulations.
- Systems, machines, and equipment that could present a risk to life or property.

Please know and observe all prohibitions of use applicable to the products.

NEVER USE THE PRODUCTS FOR AN APPLICATION INVOLVING SERIOUS RISK TO LIFE OR PROPERTY WITHOUT ENSURING THAT THE SYSTEM AS A WHOLE HAS BEEN DESIGNED TO ADDRESS THE RISKS, AND THAT THE OMRON PRODUCT IS PROPERLY RATED AND INSTALLED FOR THE INTENDED USE WITHIN THE OVERALL EQUIPMENT OR SYSTEM.

Disclaimers

CHANGE IN SPECIFICATIONS

Product specifications and accessories may be changed at any time based on improvements and other reasons.

It is our practice to change model numbers when published ratings or features are changed, or when significant construction changes are made. However, some specifications of the product may be changed without any notice. When in doubt, special model numbers may be assigned to fix or establish key specifications for your application on your request. Please consult with your OMRON representative at any time to confirm actual specifications of purchased product.

DIMENSIONS AND WEIGHTS

Dimensions and weights are nominal and are not to be used for manufacturing purposes, even when tolerances are shown.

ERRORS AND OMISSIONS

The information in this catalog has been carefully checked and is believed to be accurate; however, no responsibility is assumed for clerical, typographical, or proofreading errors, or omissions.

PERFORMANCE DATA

Performance data given in this catalog is provided as a guide for the user in determining suitability and does not constitute a warranty. It may represent the result of OMRON's test conditions, and the users must correlate it to actual application requirements. Actual performance is subject to the OMRON Warranty and Limitations of Liability.

PROGRAMMABLE PRODUCTS

OMRON shall not be responsible for the user's programming of a programmable product, or any consequence thereof.

COPYRIGHT AND COPY PERMISSION

This catalog shall not be copied for sales or promotions without permission.

This catalog is protected by copyright and is intended solely for use in conjunction with the product. Please notify us before copying or reproducing this catalog in any manner, for any other purpose. If copying or transmitting this catalog to another, please copy or transmit it in its entirety.