

Digital Panel Meter K3TE

Easy-to-use, Low-cost Digital Panel Meter that Accepts DC Input

- Compact DIN-size (96 x 48 (W x H)) body.
- Mounting thickness of only 3.5 mm required.
- Highly visible display with 14.2-mm-high LEDs.
- Easy-to-mount snap-in construction.
- Conforms to EMC standards EN61010-1 (IEC61010-1).



Model Number Structure

■ Model Number Legend

K3TE -
 1 2 3 4

1, 2. Input Code

V1: ± 199.9 mV
V2: ± 1.999 V
V3: ± 19.99 V
V4: ± 199.9 V
A1: ± 199.9 μ A
A2: ± 1.999 mA
A3: ± 19.99 mA
A4: ± 199.9 mA
A5: ± 1.999 A

3. Series No.

1: Current series

4. Supply Voltage

4: 100 to 120 VAC
5: 200 to 240 VAC
6: 24 VDC (internally insulated)

Ordering Information

■ List of Models

Range	Measuring ranges	Supply voltage		
		100 to 120 VAC	200 to 240 VAC	24 VDC (internally insulated)
DC voltage	±199.9 mV	K3TE-V114	K3TE-V115	K3TE-V116
	±1.999 V	K3TE-V214	K3TE-V215	K3TE-V216
	±19.99 V	K3TE-V314	K3TE-V315	K3TE-V316
	±199.9 V	K3TE-V414	K3TE-V415	K3TE-V416
DC current	±199.9 μA	K3TE-A114	K3TE-A115	K3TE-A116
	±1.999 mA	K3TE-A214	K3TE-A215	K3TE-A216
	±19.99 mA	K3TE-A314	K3TE-A315	K3TE-A316
	±199.9 mA	K3TE-A414	K3TE-A415	K3TE-A416
	±1.999 mA	K3TE-A514	K3TE-A515	K3TE-A516

Note: The K3TE-V4□□ does not conform to CE marking standards.

■ Accessories (Order Separately)

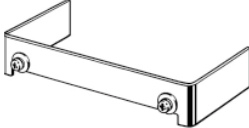
Name	Appearance	Model
Water-resistive Soft Front Cover		K32-L49SC
Water-resistive Mounting Bracket		K32-L49MB

Note: Be sure to use the Soft Front Cover and Mounting Bracket as a set.

Specifications

■ Ratings

Supply voltage	100 to 120 VAC; 200 to 240 VAC (50/60 Hz); 24 VDC (internally insulated)
Operating voltage range	-15% to +10% of supply voltage
Power consumption	3 VA (at max. AC load); 1.3 W (at max. DC load) (see note)
Insulation resistance	10 M Ω min. (at 500 VDC) between external terminal and case
Dielectric strength	AC model: 2,000 VAC min. for 1 min between input terminal and power supply DC model: 500 VDC min. for 1 min between input terminal and power supply AC/DC model: 2,000 VAC min. for 1 min between external terminal and case
Noise immunity	AC model: \pm 1,500 V on power supply terminals in normal or common mode DC model: \pm 480 V on power supply terminals in normal mode \pm 1,500 V on power supply terminals in common mode
Vibration resistance	Malfunction: 10 to 55 Hz, 0.5-mm single amplitude for 10 min each in X, Y, and Z directions Destruction: 10 to 55 Hz, 0.75-mm single amplitude for 2 hrs each in X, Y, and Z directions
Shock resistance	Malfunction: 98 m/s ² for 3 times each in 6 directions Destruction: 294 m/s ² for 3 times each in 6 directions
Ambient temperature	Operating: -10° to 55°C (with no icing) Storage: -20° to 65°C (with no icing)
Ambient humidity	Operating: 35% to 85% (with no condensation)
Ambient operating atmosphere	No corrosive gas
EMC	(EMI) EN61326+A1 Industry Emission Enclosure: CISPR 11 Group 1 class A: CISRP16-1/-2 Emission AC Mains: CISPR 11 Group 1 class A: CISRP16-1/-2 (EMS) EN61326+A1 Industry Immunity ESD: EN61000-4-2: 4 kV contact discharge (level 2) 8 kV air discharge (level 3) Immunity RF-interference: EN61000-4-3: 10 V/m (amplitude-modulated, 80 MHz to 1 GHz) (level 3) Immunity Fast Transient Noise: EN61000-4-4: 2 kV (power line) (level 3) Immunity Burst Noise: 1 kV line to line (I/O signal line) Immunity Surge: EN61000-4-5: 1 kV line to line 2 kV line to ground (power line) Immunity Conducted Disturbance EN61000-4-6: 3 V (0.15 to 80 MHz) (level 2) Immunity Voltage Dip/Interrupting EN61000-4-11: 0.5 cycles, 0, 180°, 100% (rated voltage)
Approved standards	Conforms to EN61326+A1, EN61010-1 (IEC61010-1) Conforms to VDE0106/P100 (finger protection) when the terminal cover is mounted.

- Note:** 1. An inrush current of approximately 0.5 A will flow at the moment the power is turned on and continued for approximately 2 ms.
2. The K3TE-V4□□ does not conform to CE marking standards.

■ Characteristics

Input signal	DC voltage/current
A/D conversion method	Double integral method
Sampling period	2.5 times/s
Display refresh period	2.5 times/s
Max. displayed digits	3 1/2 digits (\pm 1999)
Display	7-segment red LED
Decimal point display position	By short-circuiting terminals
Sign display	"-" is displayed automatically with a negative input signal
Overflow/underflow display	Overflow: #□□□ Underflow: - #□□□
Zero suppression	Not supported.
External control	Process value hold (terminals on rear panel short-circuited)
Degree of protection	Front panel: IEC IP51 (see note) Case: IEC IP20 Terminals: IEC IP00

Note: IP51 is maintained when the water-resistant soft cover and bracket are used. IP50 will be, however, maintained without these water-resistant accessories.

Measuring Ranges

Input range	Measuring range	Max. resolution	Input impedance	Accuracy	Max. permissible load
DC voltage	±199.9 mV	100 μV	100 MΩ	±0.1%rdg ±1 digit	±250 V
	±1.999 V	1 mV	100 MΩ	±0.1%rdg ±1 digit	±250 V
	±19.99 V	10 mV	10 MΩ	±0.1%rdg ±1 digit	±250 V
	±199.9 V	100 mV	10 MΩ	±0.1%rdg ±1 digit	±350 V
DC current	±199.9 μA	100 nA	1 kΩ	±0.1%rdg ±1 digit	±10 mA
	±1.999 mA	1 μA	100 Ω	±0.1%rdg ±1 digit	±50 mA
	±19.99 mA	10 μA	10 Ω	±0.1%rdg ±1 digit	±150 mA
	±199.9 mA	100 μA	1 Ω	±0.1%rdg ±1 digit	±500 mA
	±1.999 A	1 mA	0.1 Ω	±0.3%rdg ±1 digit	±3 A

Note: The above accuracy is at an ambient temperature of 23±5°C.

Connections

External Connections

Connector and connector screws are provided with the model.

AC Power Supply

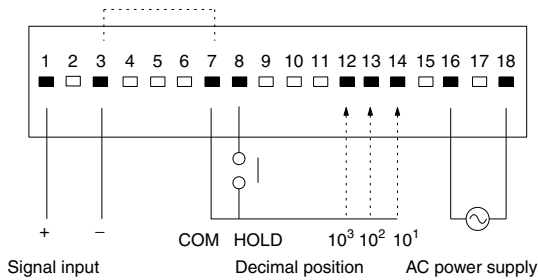

DC Power Supply

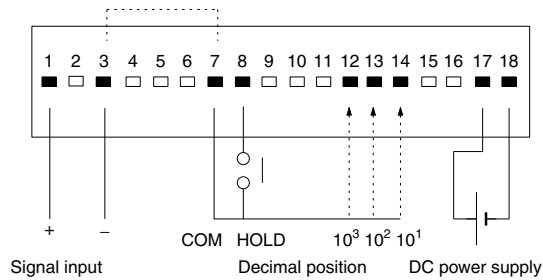

Note: 1. Terminals 3 and 7 of the AC and DC models are not internally insulated. Connect a relay with high contact reliability and insulation (with a minimum load current of 0.3 mA) or a photocoupler with high insulation (with a residual voltage of 1 V max. and a current leakage of 0.1 mA max.) to these terminals for external control.

2. The terminals marked with a white rectangular box are not used. Do not use these terminals for transmission of signals.

Nomenclature

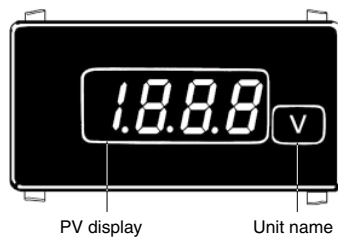

Select the decimal position with terminal 12, 13, or 14 on the rear panel.

19.9.9
10³ 10² 10¹

Dimensions

Note: All units are in millimeters unless otherwise indicated.

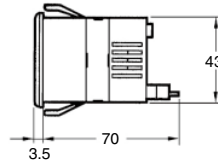
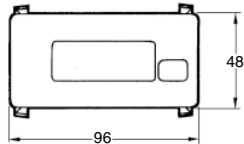
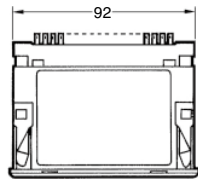
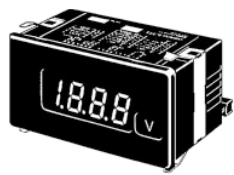

Panel Cutouts

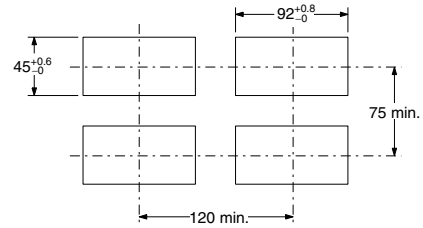

Note: The values above are recommended values. Do not group-mount the meters at intervals less than the recommended ones.

LED Indicator Size

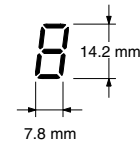

Application Examples

High DC Voltage Measurement

When voltage exceeding the maximum voltage in the standard range is measured (for example: more than 200 V), a divider is connected externally.

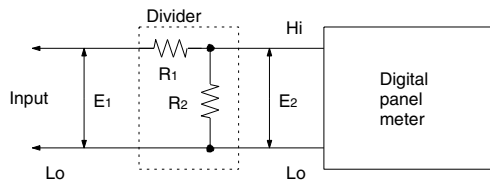

$$\frac{E_2}{E_1} = \frac{R_2}{R_1 + R_2}$$

Large DC Current Measurement

When large DC current exceeding 2 A is measured, a shunt is connected externally.

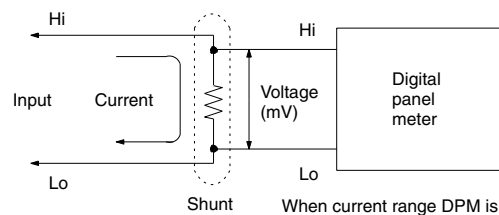

When current range DPM is used, disconnect the internal shunt resistor.

Safety Precautions

Mounting

Recommended panel thickness is 1 to 3.2 mm.

When mounting, insert the Digital Panel Meter in the mounting hole and make sure that the Digital Panel Meter is secured with mounting hooks.

Always attach the Mounting Bracket before wiring the terminals. Also, always remove the wiring before removing the Mounting Bracket.

Mount the Digital Panel Meter as horizontally as possible.

Never use the Digital Panel Meter in locations where corrosive gas (particularly sulfide or ammonia gas) is generated.

As much as possible avoid use of the Digital Panel Meter in a location subject to severe shock or vibration, excessive dust, or excessive moisture.

Select a mounting location where the Digital Panel Meter can be used at an ambient operating temperature -10° to 55°C .

No product is shipped with the unit label attached. Select a unit label from the sheet provided, and attach it to the Digital Panel Meter.

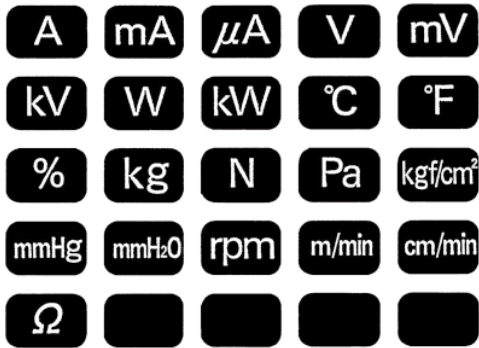

Calibration

Calibrate the Digital Panel Meter regularly so that the Digital Panel Meter can maintain processing accuracy.

Use a standard signal generator with an accuracy of 99.99% min. for calibration.

For the precise calibration methods, refer to the Instruction Sheet for the Digital Panel Meter.

After the front panel cover is removed to calibrate the K3TE, be sure not to touch components other than the calibration adjuster. Keep metal objects off the K3TE while calibrating, especially when power is turned on.

Accessories (Order Separately)

Water-resistant Soft Front Cover

Before mounting the Digital Panel Meter to a panel, attach the water-resistant soft front cover and mounting bracket to the Digital Panel Meter properly so that the Digital Panel Meter will maintain IP51 water-resistant standards. Before you calibrate Digital Panel Meters, remove the water-resistant soft front cover. Refer to the operation manual included with the Digital Panel Meter for the calibration procedure.

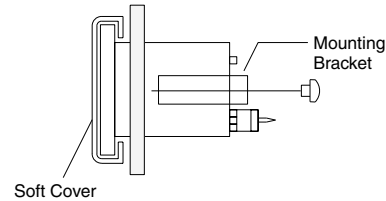

Note: Be sure to use the Water-resistant Soft Front Cover and mounting bracket together.

ALL DIMENSIONS SHOWN ARE IN MILLIMETERS.

To convert millimeters into inches, multiply by 0.03937. To convert grams into ounces, multiply by 0.03527.

In the interest of product improvement, specifications are subject to change without notice.

Read and Understand This Catalog

Please read and understand this catalog before purchasing the products. Please consult your OMRON representative if you have any questions or comments.

Warranty and Limitations of Liability

WARRANTY

OMRON's exclusive warranty is that the products are free from defects in materials and workmanship for a period of one year (or other period if specified) from date of sale by OMRON.

OMRON MAKES NO WARRANTY OR REPRESENTATION, EXPRESS OR IMPLIED, REGARDING NON-INFRINGEMENT, MERCHANTABILITY, OR FITNESS FOR PARTICULAR PURPOSE OF THE PRODUCTS. ANY BUYER OR USER ACKNOWLEDGES THAT THE BUYER OR USER ALONE HAS DETERMINED THAT THE PRODUCTS WILL SUITABLY MEET THE REQUIREMENTS OF THEIR INTENDED USE. OMRON DISCLAIMS ALL OTHER WARRANTIES, EXPRESS OR IMPLIED.

LIMITATIONS OF LIABILITY

OMRON SHALL NOT BE RESPONSIBLE FOR SPECIAL, INDIRECT, OR CONSEQUENTIAL DAMAGES, LOSS OF PROFITS, OR COMMERCIAL LOSS IN ANY WAY CONNECTED WITH THE PRODUCTS, WHETHER SUCH CLAIM IS BASED ON CONTRACT, WARRANTY, NEGLIGENCE, OR STRICT LIABILITY.

In no event shall responsibility of OMRON for any act exceed the individual price of the product on which liability is asserted.

IN NO EVENT SHALL OMRON BE RESPONSIBLE FOR WARRANTY, REPAIR, OR OTHER CLAIMS REGARDING THE PRODUCTS UNLESS OMRON'S ANALYSIS CONFIRMS THAT THE PRODUCTS WERE PROPERLY HANDLED, STORED, INSTALLED, AND MAINTAINED AND NOT SUBJECT TO CONTAMINATION, ABUSE, MISUSE, OR INAPPROPRIATE MODIFICATION OR REPAIR.

Application Considerations

SUITABILITY FOR USE

OMRON shall not be responsible for conformity with any standards, codes, or regulations that apply to the combination of products in the customer's application or use of the product.

At the customer's request, OMRON will provide applicable third party certification documents identifying ratings and limitations of use that apply to the products. This information by itself is not sufficient for a complete determination of the suitability of the products in combination with the end product, machine, system, or other application or use.

The following are some examples of applications for which particular attention must be given. This is not intended to be an exhaustive list of all possible uses of the products, nor is it intended to imply that the uses listed may be suitable for the products:

- Outdoor use, uses involving potential chemical contamination or electrical interference, or conditions or uses not described in this catalog.
- Nuclear energy control systems, combustion systems, railroad systems, aviation systems, medical equipment, amusement machines, vehicles, safety equipment, and installations subject to separate industry or government regulations.
- Systems, machines, and equipment that could present a risk to life or property.

Please know and observe all prohibitions of use applicable to the products.

NEVER USE THE PRODUCTS FOR AN APPLICATION INVOLVING SERIOUS RISK TO LIFE OR PROPERTY WITHOUT ENSURING THAT THE SYSTEM AS A WHOLE HAS BEEN DESIGNED TO ADDRESS THE RISKS, AND THAT THE OMRON PRODUCT IS PROPERLY RATED AND INSTALLED FOR THE INTENDED USE WITHIN THE OVERALL EQUIPMENT OR SYSTEM.

Disclaimers

CHANGE IN SPECIFICATIONS

Product specifications and accessories may be changed at any time based on improvements and other reasons.

It is our practice to change model numbers when published ratings or features are changed, or when significant construction changes are made. However, some specifications of the product may be changed without any notice. When in doubt, special model numbers may be assigned to fix or establish key specifications for your application on your request. Please consult with your OMRON representative at any time to confirm actual specifications of purchased product.

DIMENSIONS AND WEIGHTS

Dimensions and weights are nominal and are not to be used for manufacturing purposes, even when tolerances are shown.

ERRORS AND OMISSIONS

The information in this catalog has been carefully checked and is believed to be accurate; however, no responsibility is assumed for clerical, typographical, or proofreading errors, or omissions.

PERFORMANCE DATA

Performance data given in this catalog is provided as a guide for the user in determining suitability and does not constitute a warranty. It may represent the result of OMRON's test conditions, and the users must correlate it to actual application requirements. Actual performance is subject to the OMRON Warranty and Limitations of Liability.

PROGRAMMABLE PRODUCTS

OMRON shall not be responsible for the user's programming of a programmable product, or any consequence thereof.

COPYRIGHT AND COPY PERMISSION

This catalog shall not be copied for sales or promotions without permission.

This catalog is protected by copyright and is intended solely for use in conjunction with the product. Please notify us before copying or reproducing this catalog in any manner, for any other purpose. If copying or transmitting this catalog to another, please copy or transmit it in its entirety.