

Muilt - 6 Pack, Inductors and Transformers

PM600 / PM610 / PM620 Series

Special Features:

- Six windings offer many inductor or transformer configuration
- High magnetic coupling
- Non-gapped and gapped core construction
- Low core loss at high frequency applications
- Low noise radiation
- Compact size and low profile
- Dielectric strength: 500 Vrms between windings
- Operating temperature: -40 to +105 °C
- Tape & Reel packaging:
 - PM600, 600/reel
 - PM610, 300/reel
 - PM620, 200/reel

Typical Applications:

- Inductors: buck, boost, buck-boost, coupled, input, output, choke, filter, resonant, high-Q, EMI/RFI filtering, differential, forward, common mode
- Transformers: flyback, forward, push-pull, bridge, multiple outputs, inverter, step-up, step-down, gate drive, base drive, signal, wide band, pulse, impedance, isolation, converter

Notes:

1. Saturation current is rated to each winding that causes inductance to drop 30% from its initial value.
2. Rms current is rated to each winding that causes 40°C temperature rise.
3. PM600-01, -02, PM610-01, -02
PM620-01, -02 are non gap core.

Part Number	L (uH) @ 100KHz	DCR (Ω) Max.	Isat (A)	Irms (A)
PM600-01	201.6 ±30%	0.324	0.02	0.46
PM600-02	89.6 ±30%	0.137	0.03	0.71
PM600-03	27.4 ±10%	0.324	0.31	0.46
PM600-04	12.2 ±10%	0.137	0.47	0.71
PM600-05	14.7 ±10%	0.324	0.58	0.46
PM600-06	6.5 ±10%	0.137	0.87	0.71
PM600-07	10.9 ±10%	0.324	0.88	0.46
PM600-08	4.9 ±10%	0.137	1.32	0.71
PM600-09	8.5 ±10%	0.324	1.23	0.46
PM600-10	3.8 ±10%	0.137	1.85	0.71
PM610-01	160.0 ±30%	0.202	0.04	0.68
PM610-02	78.4 ±30%	0.094	0.06	1.00
PM610-03	21.6 ±10%	0.202	0.67	0.68
PM610-04	10.6 ±10%	0.094	0.96	1.00
PM610-05	11.6 ±10%	0.202	1.30	0.68
PM610-06	5.7 ±10%	0.094	1.86	1.00
PM610-07	8.3 ±10%	0.202	2.00	0.68
PM610-08	4.1 ±10%	0.094	2.86	1.00
PM610-09	6.6 ±10%	0.202	2.30	0.68
PM610-10	3.2 ±10%	0.094	3.29	1.00
PM620-01	160.6 ±30%	0.094	0.03	1.28
PM620-02	77.0 ±30%	0.065	0.04	1.54
PM620-03	131.8 ±20%	0.094	0.08	1.28
PM620-04	63.2 ±20%	0.065	0.12	1.54
PM620-05	23.3 ±10%	0.094	0.36	1.28
PM620-06	11.2 ±10%	0.065	0.52	1.54
PM620-07	14.2 ±10%	0.094	0.76	1.28
PM620-08	6.8 ±10%	0.065	1.10	1.54
PM620-09	9.3 ±10%	0.094	1.11	1.28
PM620-10	4.5 ±10%	0.065	1.60	1.54
PM620-11	7.9 ±10%	0.094	1.40	1.28
PM620-12	3.8 ±10%	0.065	2.02	1.54

J.W. Miller

M A G N E T I C S

306 E. Alondra Blvd., Gardena, CA 90247-1059 • (310) 515-1720 • FAX (310) 515-1962

www.jwmiller.com

Mechanical Dimensions: (mm)

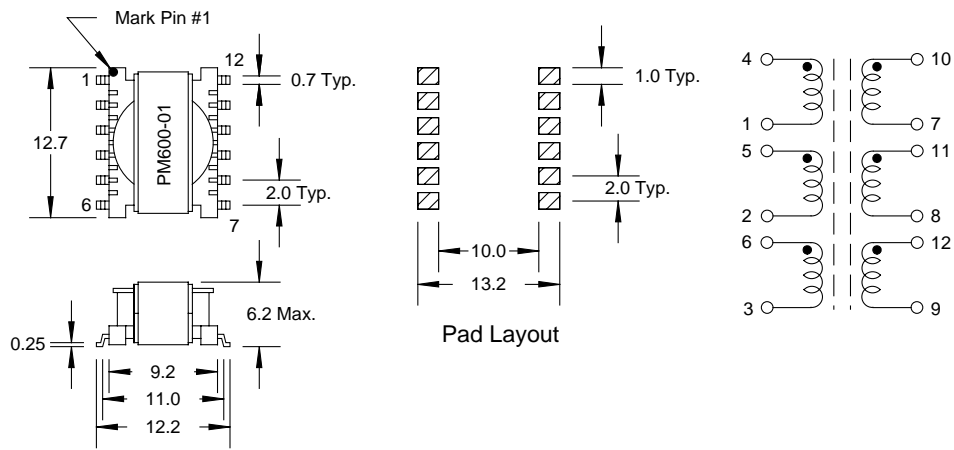

PM600-xx

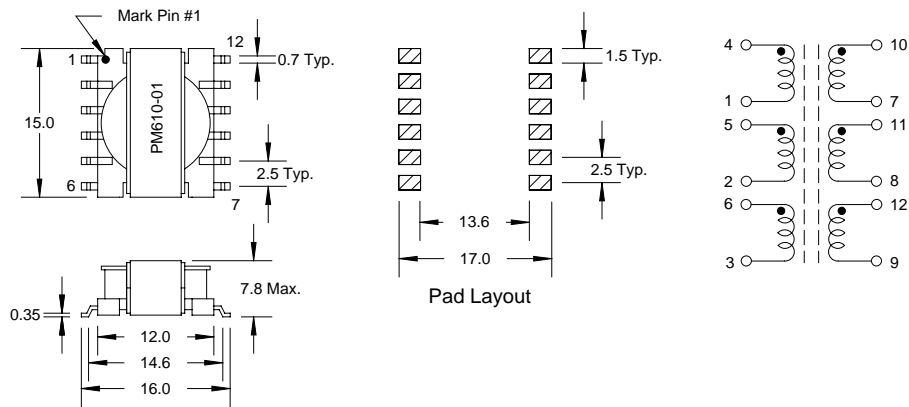

PM610-xx

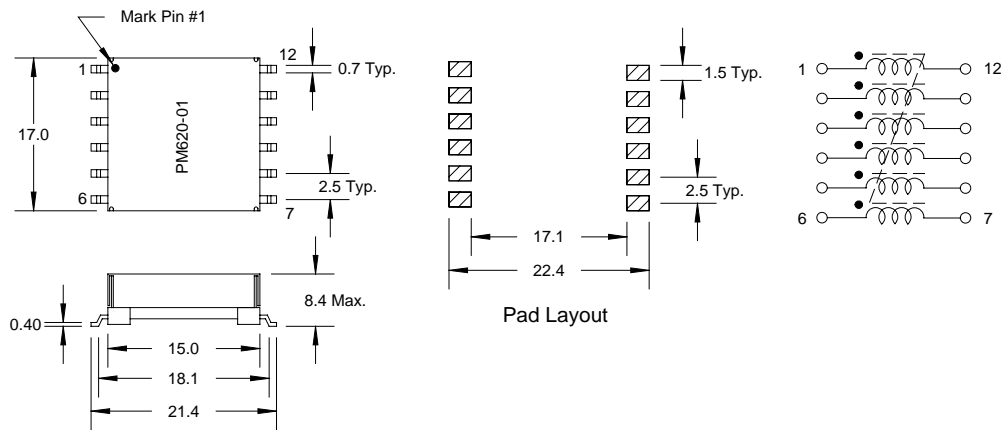

PM6200-xx

J.W. Miller
MAGNETICS

306 E. Alondra Blvd., Gardena, CA 90247-1059 • (310) 515-1720 • FAX (310) 515-1962

www.jwmiller.com

Typical Configurations

Inductor

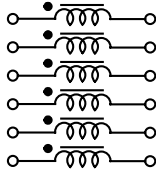

Basic Diagram
Inductance: L
Current: I

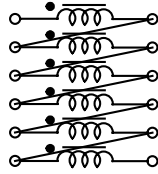

Figure 1
Inductance: $36 \times L$
Current: I

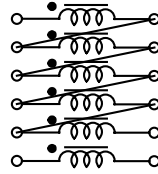

Figure 2
Inductance: $25 \times L$
Current: I

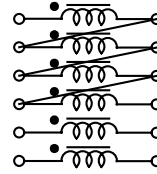

Figure 3
Inductance: $16 \times L$
Current: I

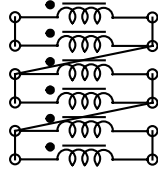

Figure 4
Inductance: $9 \times L$
Current: $2 \times I$

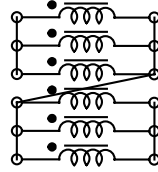

Figure 5
Inductance: $4 \times L$
Current: $3 \times I$

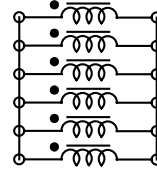
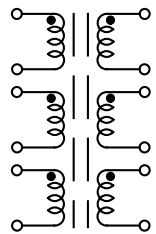

Figure 6
Inductance: L
Current: $6 \times I$

Transformer



Basic Diagram
Turns ratio:
 $1:1:1:1:1:1$

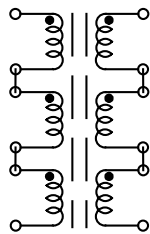

Figure 2
Turns ratio:
 $1:1$

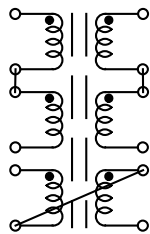

Figure 2
Turns ratio:
 $1:1:1$

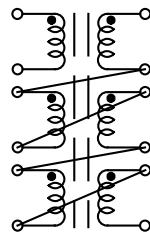

Figure 3
Turns ratio:
 $1:5$ or $5:1$

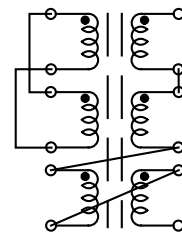

Figure 4
Turns ratio:
 $1:4$ or $4:1$

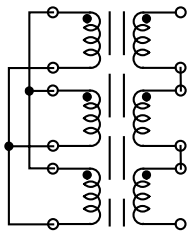

Figure 5
Turns ratio:
 $1:3$ or $3:1$

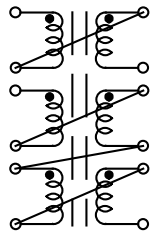

Figure 6
Turns ratio:
 $1:2$ or $2:1$

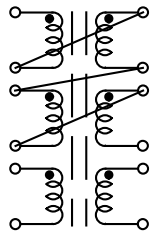

Figure 7
Turns ratio:
 $4:1:1$

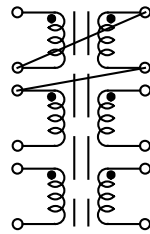

Figure 8
Turns ratio:
 $3:1:1:1$

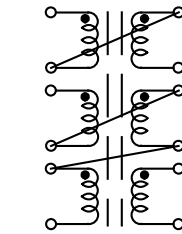

Figure 9
Turns ratio:
 $2:3$ or $3:2$

J.W. Miller

M A G N E T I C S

306 E. Alondra Blvd., Gardena, CA 90247-1059 • (310) 515-1720 • FAX (310) 515-1962

www.jwmiller.com