

Spezifikation für Freigabe / specification for release

Kunde / customer :
 Artikelnummer / part number : **744873100**
 Bezeichnung : **DOPPELDROSSEL WE-DD**
 description : **POWER-CHOKE WE-DD**



DATUM / DATE : 2009-11-01

A Mechanische Abmessungen / dimensions:

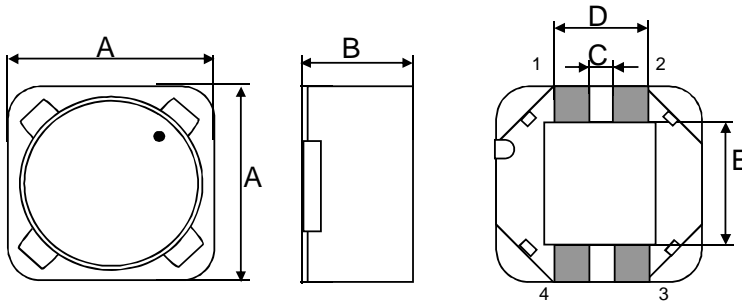

| | Typ XL | |
|---|------------------|----|
| A | 12,5 max. | mm |
| B | 8,5 max. | mm |
| C | 1,5 ± 0,2 | mm |
| D | 4,9 ± 0,2 | mm |
| E | 7,3 ± 0,5 | mm |

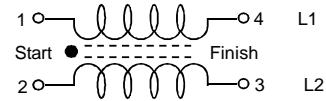

B Elektrische Eigenschaften / electrical properties:

| Eigenschaften / properties | Testbedingungen / test conditions | | Wert / value | Einheit / unit | tol. |
|--|---|-------------------------|--------------|------------------|-------------|
| Induktivität (je Wicklg.) / inductance (each wdg.) | 100 kHz / 5mA | L_1, L_2 | 10,0 | μH | $\pm 20\%$ |
| DC-Widerstand (je Wicklg.) / DC-resistance (each wdg.) | @ 20°C | $R_{DC1,2 \text{ typ}}$ | 31,0 | $\text{m}\Omega$ | typ. |
| DC-Widerstand (je Wicklg.) / DC-resistance (each wdg.) | @ 20°C | $R_{DC1,2 \text{ max}}$ | 36,0 | $\text{m}\Omega$ | max. |
| Nennstrom (je Wicklg.) ⁽¹⁾ / rated Current (each wdg.) ⁽¹⁾ | $\Delta T = 40 \text{ K}$ | I_{N1}, I_{N2} | 3,81 | A | max. |
| Sättigungsstrom (je Wicklg.) / saturation current (each wdg.) | $\Delta L/L_0 = -10\%$ | I_{sat} | 7,20 | A | typ. |
| Eigenres.-Frequenz ⁽²⁾ / self-res.-frequency ⁽²⁾ | | SRF | 20,00 | MHz | typ. |
| Nennspannung / rated voltage | | U_{DC} | 80,0 | V | max. |

⁽¹⁾ both windings driven by rated current will occur ΔT /
 Stromfluss durch beide Wicklungen verursachen ΔT

⁽²⁾ both windings in parallel /
 beide Wicklungen parallel

C Lötpad / soldering spec.:

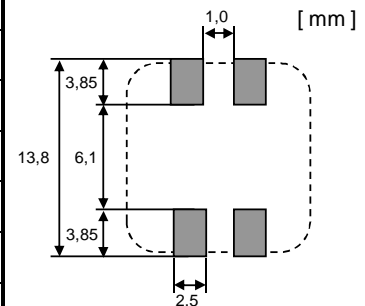

D Prüfgeräte / test equipment:

WK 3260B für/for L und/and I_{DC}
GMC Metrahit 271 für/for R_{DC}
HP E4991A für/for SRF

E Testbedingungen / test conditions:

Luftfeuchtigkeit / humidity: 33%
 Umgebungstemperatur / temperature: +20°C

F Werkstoffe & Zulassungen / material & approvals:

Basismaterial / base material: Ferrit/ ferrite
 Draht / wire: 2 SFHW; 180°C
 UL-File Number: E174837

G Eigenschaften / general specifications:

Betriebstemp. / operating temperature: -40°C - + 125°C
 Umgebungstemp. / ambient temperature: -40°C - + 85°C
 It is recommended that the temperature of the part does not exceed 125°C under worst case operating conditions.

| | | | |
|-------------------------------------|---------------------------------|-------------------------|--------------|
| Freigabe erteilt / general release: | Kunde / customer | | |
| | | | |
| Datum / date | Unterschrift / signature | | |
| | Würth Elektronik | | |
| Geprüft / checked | Kontrolliert / approved | | |
| | OO | Version 1 | 09-11-01 |
| | Name | Änderung / modification | Datum / date |

Würth Elektronik eiSos GmbH & Co. KG

D-74638 Waldenburg · Max-Eyth-Strasse 1 · Germany · Telefon (+49) (0) 7942 - 945 - 0 · Telefax (+49) (0) 7942 - 945 - 400
<http://www.we-online.de>

Spezifikation für Freigabe / specification for release

Kunde / customer : _____
 Artikelnummer / part number : **744873100**
 Bezeichnung : **DOPPELDROSSEL WE-DD**
 description : **POWER-CHOKE WE-DD**



DATUM / DATE : 2009-11-01

I Rollenspezifikation / tape and reel specification:

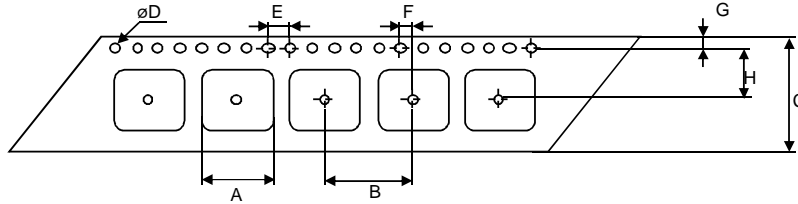

| Gurtspezifikation / Tape specification: | | |
|---|-------------------------|----|
| A | 12,5 ± 0,1 | mm |
| B | 16,0 ± 0,1 | mm |
| C | 24,0 ± 0,3 | mm |
| D | 1,50 +0,1 / -0,0 | mm |
| E | 4,00 ± 0,1 | mm |
| F | 2,00 ± 0,1 | mm |
| G | 1,75 ± 0,1 | mm |
| H | 11,5 ± 0,1 | mm |
| I | 12,6 ± 0,1 | mm |
| J | 8,50 ± 0,1 | mm |
| T | 0,40 ± 0,05 | mm |

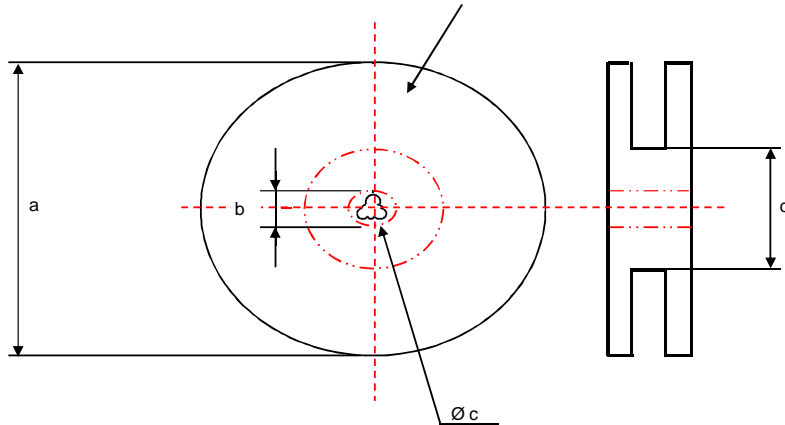
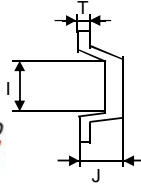

| Rollenspezifikation / Reel specification: | | |
|---|--------------------|----|
| a | 330,0 ± 2,0 | mm |
| b | 21,00 ± 0,8 | mm |
| c | 13,00 ± 0,5 | mm |
| d | 100,0 ± 1,0 | mm |

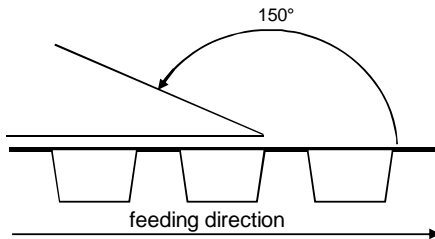

The force for tearing off cover tape is 20 to 70 grams in arrow direction

| | | | |
|-------------------------------------|--------------------------|------|--------------------------------------|
| Freigabe erteilt / general release: | Kunde / customer | | |
| | | | |
| Datum / date | Unterschrift / signature | | |
| | Würth Elektronik | | |
| | | | |
| Geprüft / checked | Kontrolliert / approved | OO | Version 1 09-11-01 |
| | | Name | Änderung / modification Datum / date |

This electronic component has been designed and developed for usage in general electronic equipment. Before incorporating this component into any equipment where higher safety and reliability is especially required or if there is the possibility of direct damage or injury to human body, for example in the range of aerospace, aviation, nuclear control, submarine, transportation, (automotive control, train control, ship control), transportation signal, disaster prevention, medical, public information network etc, Würth Elektronik eiSos GmbH must be informed before the design-in stage. In addition, sufficient reliability evaluation checks for safety must be performed on every electronic component which is used in electrical circuits that require high safety and reliability functions or performance.

Würth Elektronik eiSos GmbH & Co. KG

D-74638 Waldenburg · Max-Eyth-Strasse 1 · Germany · Telefon (+49) (0) 7942 - 945 - 0 · Telefax (+49) (0) 7942 - 945 - 400
<http://www.we-online.de>