

SAW FILTER FOR GPS

Murata part number :SAFEA1G57KE0F00

Package Dimensions

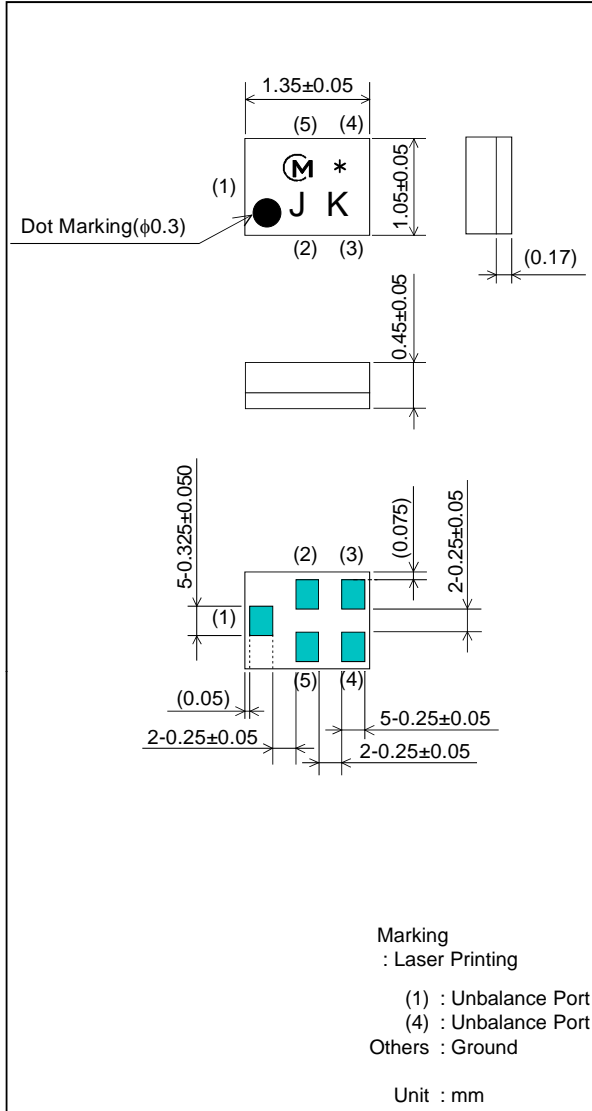

Specification

Item	Specification		
	-30 to 85°C	25±2°C	typ.
Nominal Center Frequency(fc)	1575.5MHz		
Insertion Loss (1573.92 to 1576.92MHz)	1.3 dB max.	1.2 dB max.	1.1 dB
Absolute Attenuation			
1) 0.1 to 250 MHz	40 dB min.	40 dB min.	47 dB
2) 250 to 810 MHz	41 dB min.	41 dB min.	43 dB
3) 810 to 960 MHz	40 dB min.	40 dB min.	44 dB
4) 960 to 1429 MHz	40 dB min.	40 dB min.	47 dB
5) 1429 to 1453 MHz	40 dB min.	40 dB min.	45 dB
6) 1453 to 1525.42 MHz	37 dB min.	37 dB min.	42 dB
7) 1525 to 1560 MHz	1.1 dB min.	1.1 dB min.	1.7 dB
8) 1625 to 1710 MHz	40 dB min.	40 dB min.	50 dB
9) 1710 to 1749.9 MHz	43 dB min.	43 dB min.	50 dB
10) 1749.9 to 1785 MHz	44 dB min.	44 dB min.	50 dB
11) 1785 to 1920 MHz	43 dB min.	43 dB min.	46 dB
12) 1920 to 1990 MHz	41 dB min.	41 dB min.	45 dB
13) 1990 to 2170 MHz	40 dB min.	40 dB min.	44 dB
14) 2170 to 2700 MHz	35 dB min.	35 dB min.	40 dB
15) 2700 to 6000 MHz	30 dB min.	30 dB min.	33 dB
Ripple Deviation (1573.92 to 1576.92MHz)	0.6dB max.	0.5dB max.	0.1 dB
VSWR (1573.92 to 1576.92MHz)	1.7 max.	1.5 max.	1.3
Unbalance Port Matching Impedance (nominal)	50Ω		
Input Signal Level	20mW (+13dBm), 2000 hours		

SAW FILTER FOR GPS

Murata part number :SAFEA1G57KE0F00

■ Frequency Performance

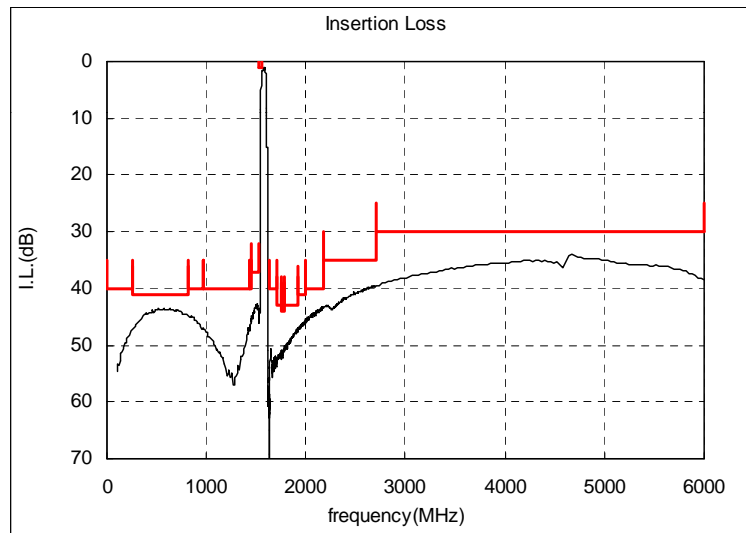
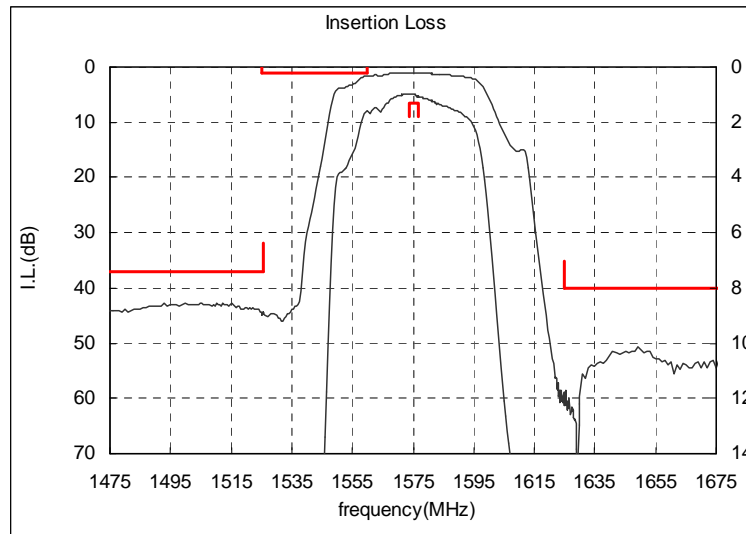

SAW FILTER FOR GPS

Murata part number :SAFEA1G57KE0F00

■ Dimensions of Carrier Tape

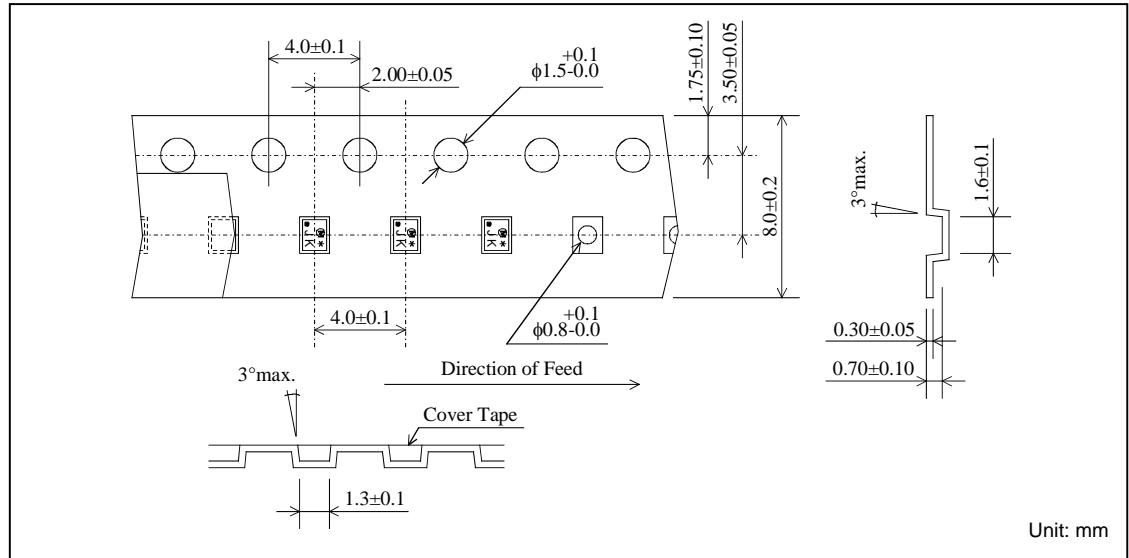

■ Dimensions of Tape

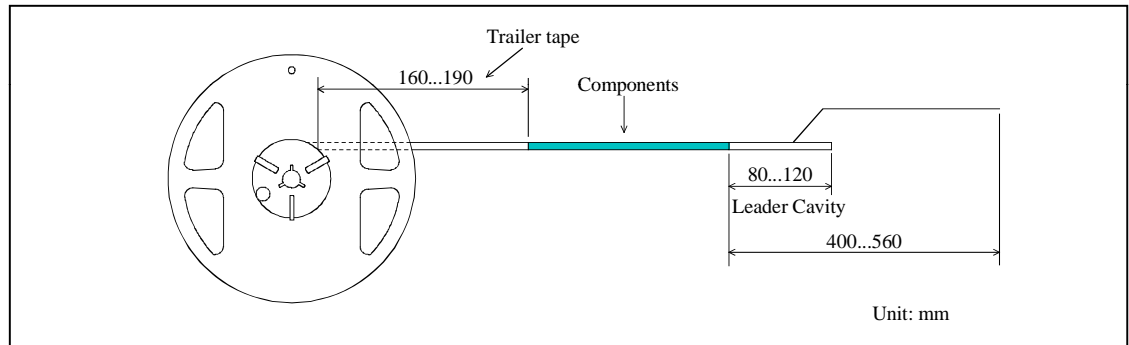

■ Dimensions of Reel

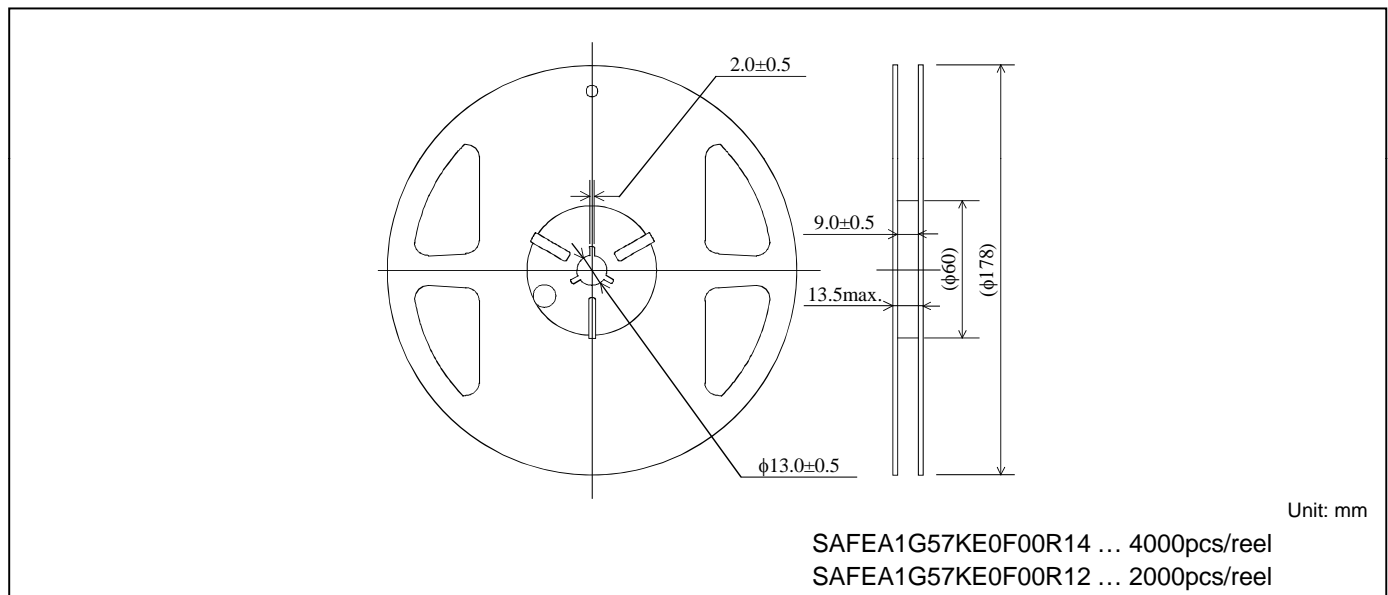

SAW FILTER FOR GPS

Murata part number :SAFEA1G57KE0F00

Recommended Land Pattern

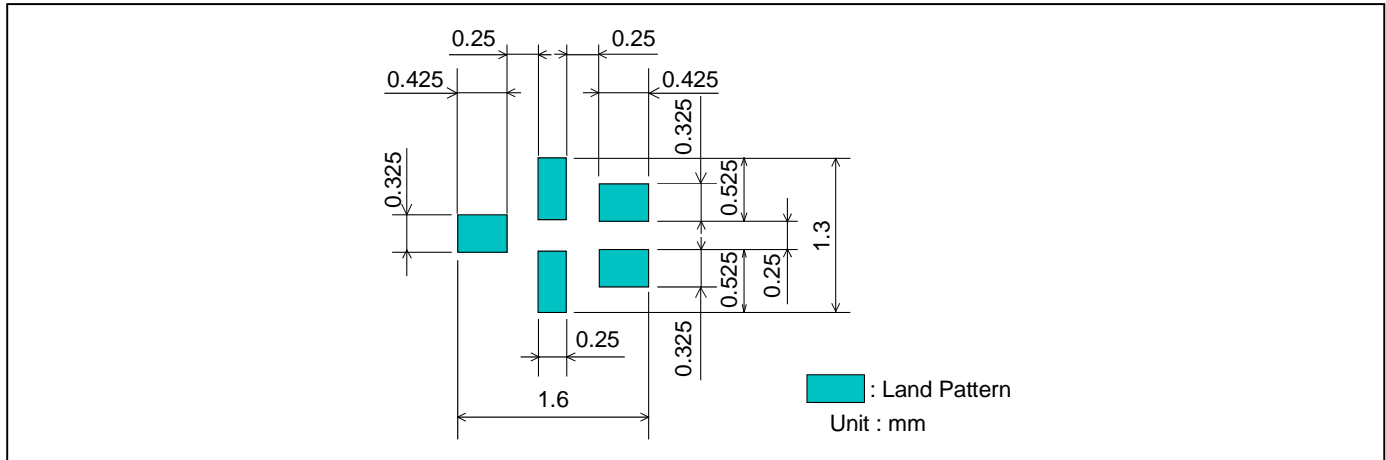

Test Circuit

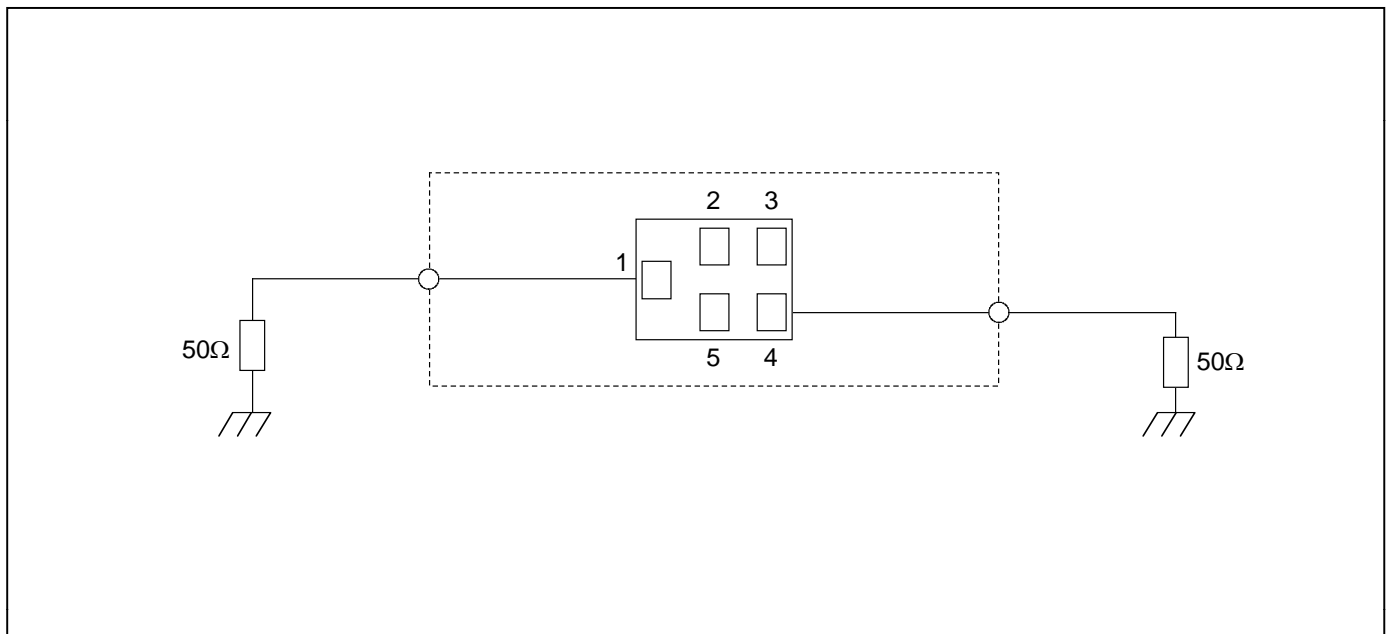

- This PDF Datasheet is downloaded from the website of Murata Manufacturing Co., Ltd. Therefore, it's specifications are subject to change or our products in it may be discontinued without advance notice. Please check with our sales representatives or product engineers before ordering.
- This PDF Datasheet has only typical specifications because there is no space for detailed specifications. Therefore, please approve our product specifications or transact the approval sheet for product specifications before ordering.