

SAW FILTER FOR ISM

Murata part number :SAFEB915MAL0F00

Package Dimensions

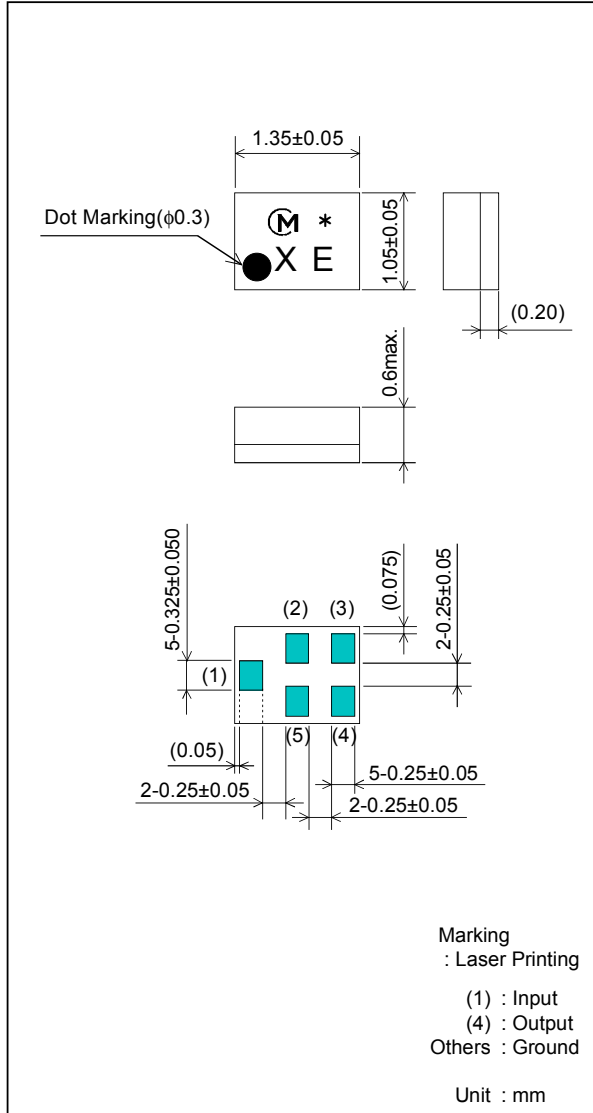

Specification

Item	Specification	
	-30 to +85°C	typ.
Nominal Center Frequency(f_c)	915 MHz	
Insertion Loss (902 to 928 MHz)	2.5 dB max.	1.8 dB
Absolute Attenuation		
1) 0.1 to 702 MHz	50 dB min.	60 dB
2) 738 to 764 MHz	49 dB min.	61 dB
3) 820 to 846 MHz	42 dB min.	59 dB
4) 990 to 1010 MHz	42 dB min.	51 dB
5) 1072 to 1092 MHz	49 dB min.	66 dB
6) 1128 to 1804 MHz	45 dB min.	54 dB
7) 1804 to 1856 MHz	40 dB min.	58 dB
8) 1856 to 3000 MHz	30 dB min.	47 dB
Ripple Deviation (902 to 928 MHz)	1.0 dB max.	0.3 dB
Return Loss (902 to 928 MHz)	10 dB min.	14 dB
Group Delay Time Deviation (902 to 928 MHz)	50 ns min.	12 ns
Input/Output Impedance (nominal)	50Ω	
Input Signal Level	31.6mW (+15dBm), 2000 hours	

SAW FILTER FOR ISM

Murata part number :SAFEB915MAL0F00

■ Frequency Performance

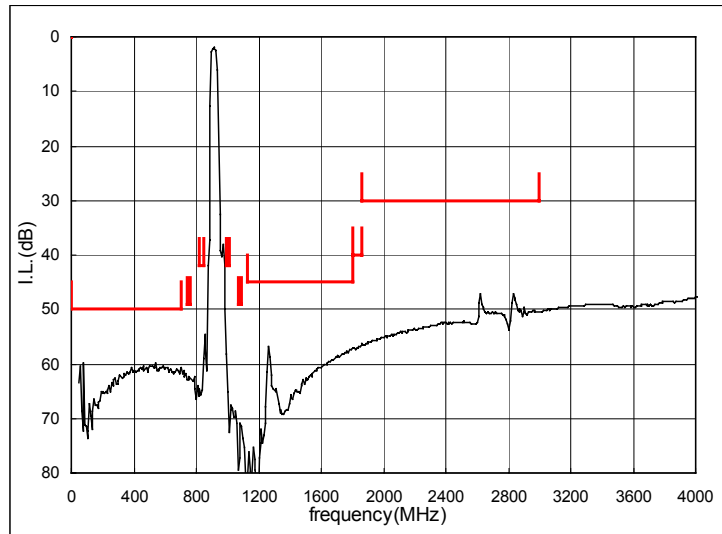
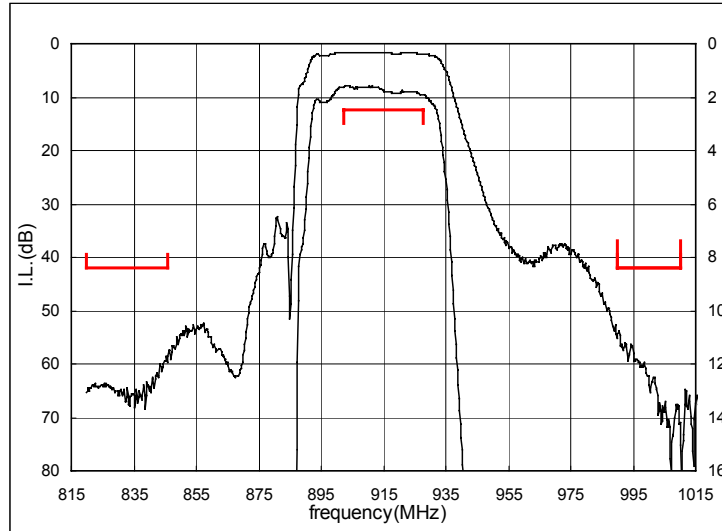

SAW FILTER FOR ISM

Murata part number :SAFEB915MAL0F00

■ Dimensions of Carrier Tape

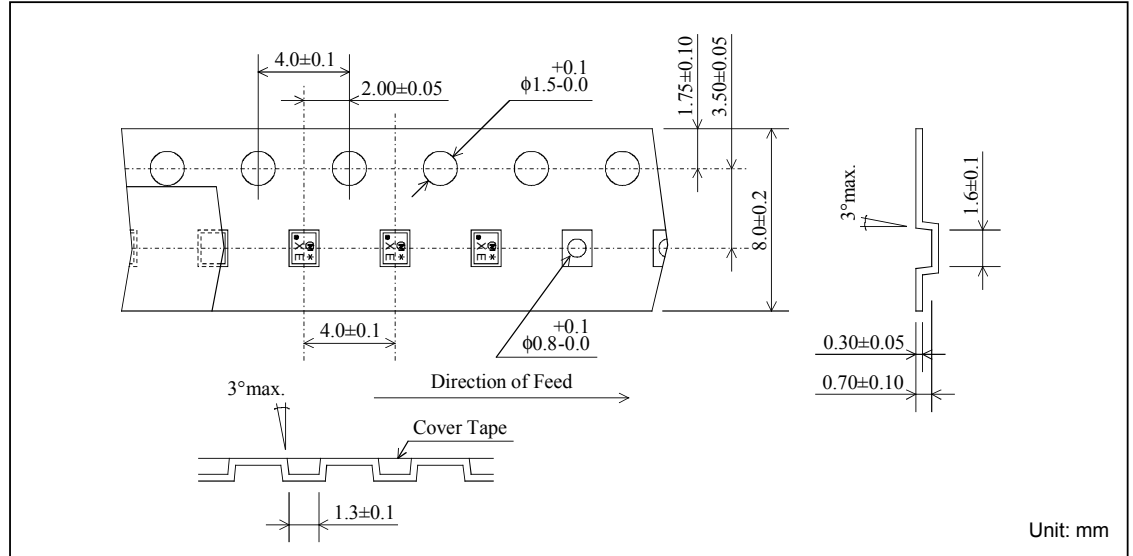

■ Dimensions of Tape

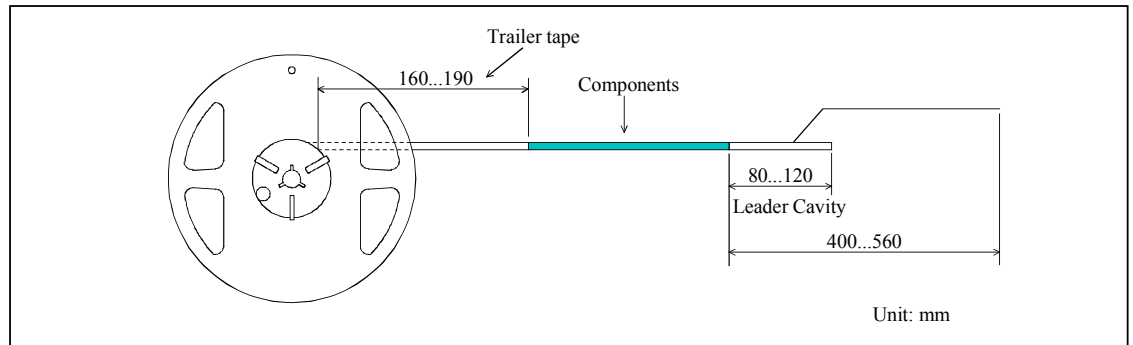

■ Dimensions of Reel

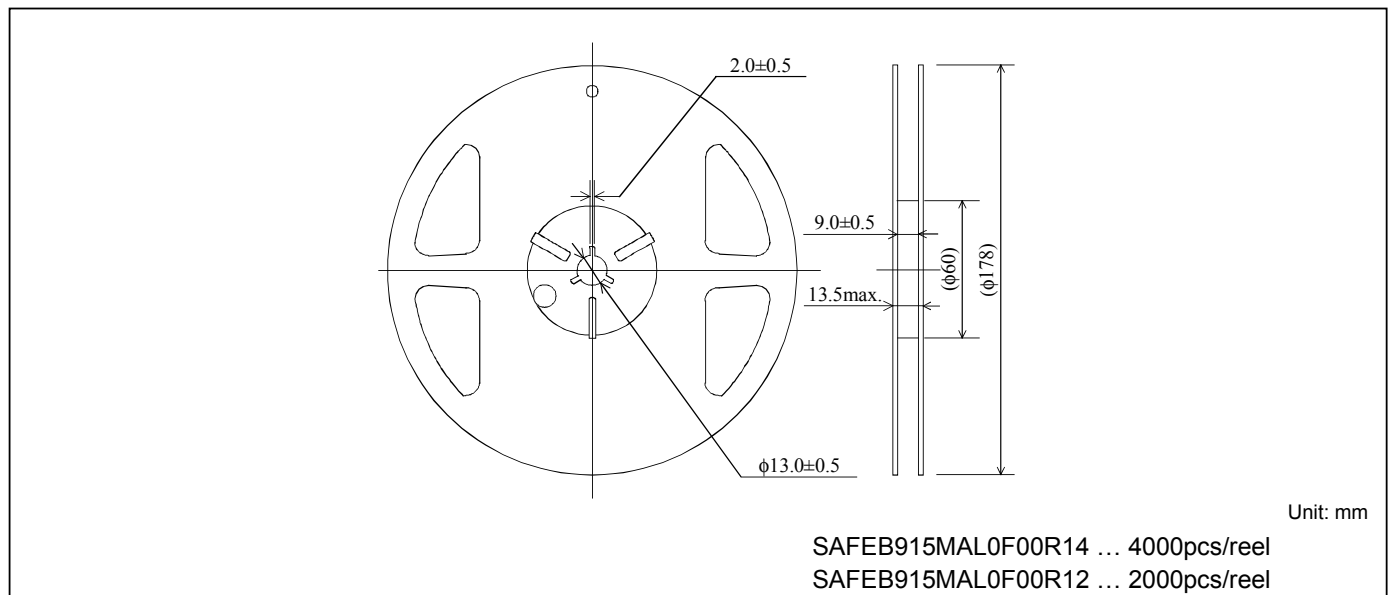

SAW FILTER FOR ISM

Murata part number :SAFEB915MAL0F00

Recommended Land Pattern

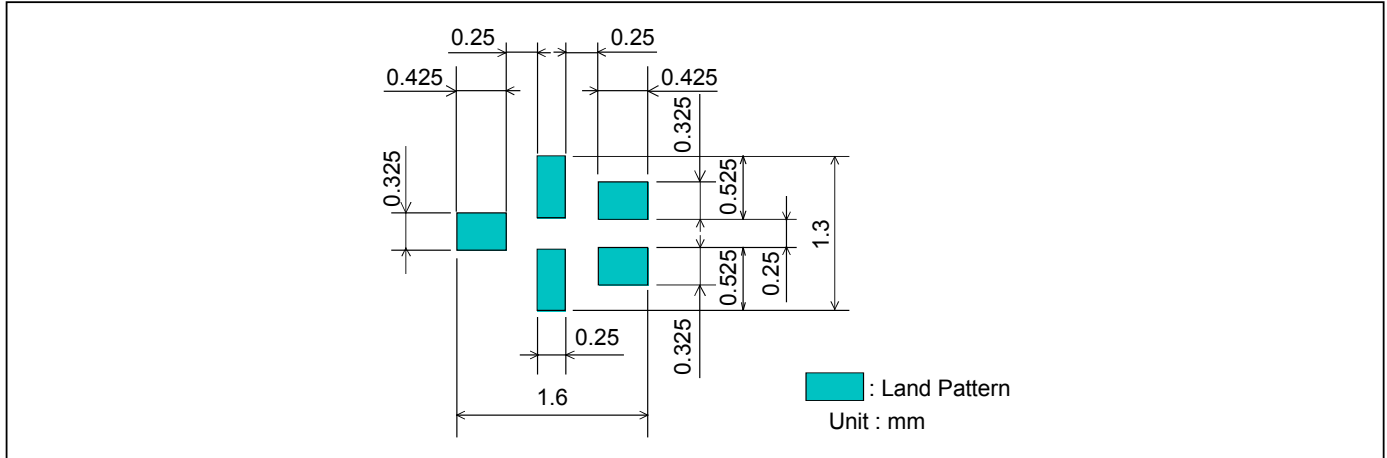

Test Circuit

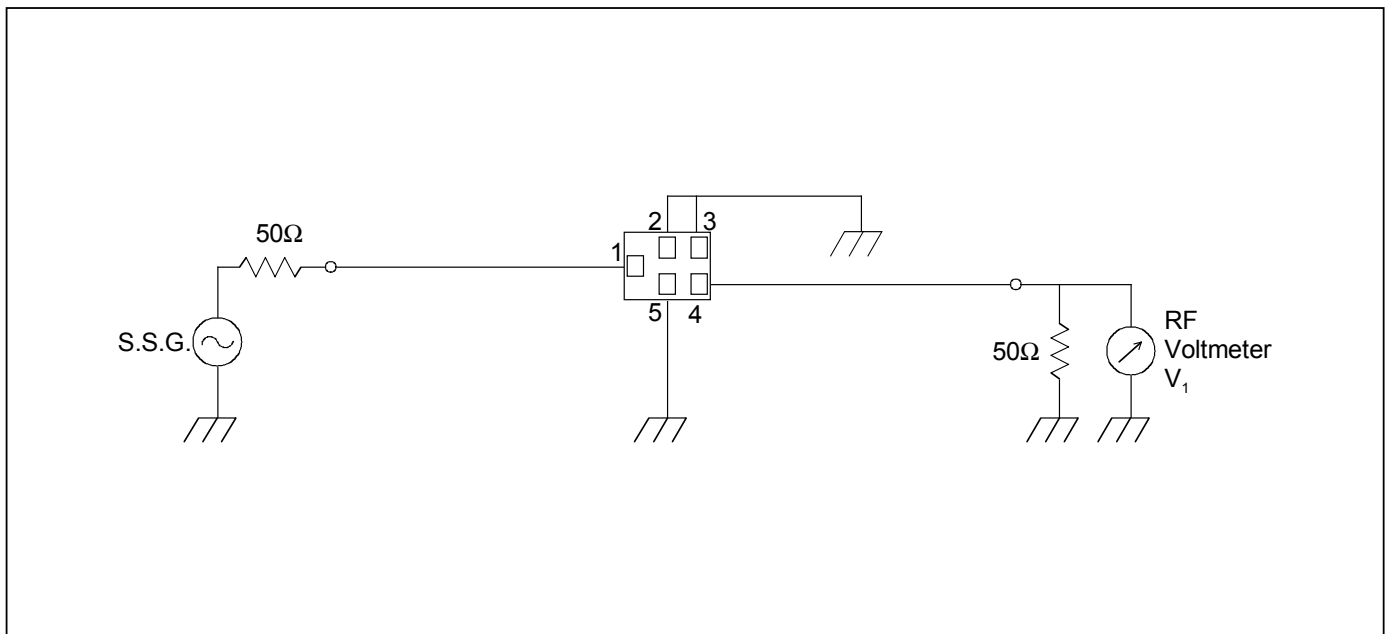

- This PDF Datasheet is downloaded from the website of Murata Manufacturing Co., Ltd. Therefore, it's specifications are subject to change or our products in it may be discontinued without advance notice. Please check with our sales representatives or product engineers before ordering.
- This PDF Datasheet has only typical specifications because there is no space for detailed specifications. Therefore, please approve our product specifications or transact the approval sheet for product specifications before ordering.