

SAW FILTER FOR Bluetooth

Murata part number : SAFEA2G44AA0F00

■ Package Dimensions

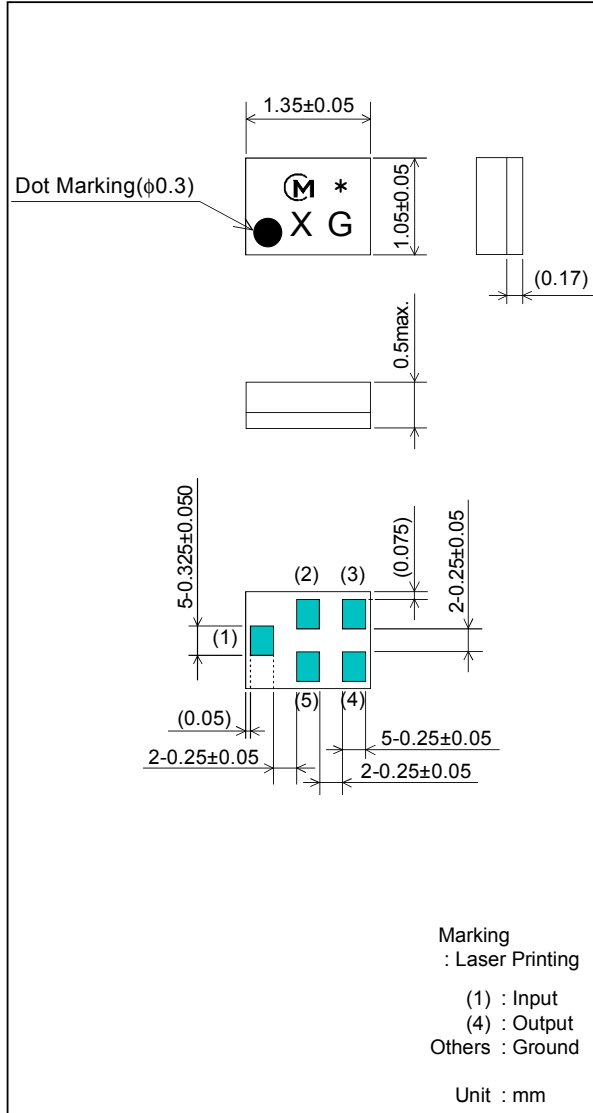

■ Specification

Item	Specification		
	-30 to 85°C	25±2°C	typ.
Nominal Center Frequency(fc)	2441.75MHz		
Insertion Loss (2400 to 2483.5MHz)	2.8 dB max.	2.5 dB max.	2.0 dB
Absolute Attenuation			
1) 0.1 to 960 MHz	35 dB min.	35 dB min.	39 dB
2) 1570 to 1990 MHz	32 dB min.	32 dB min.	38 dB
3) 2110 to 2170 MHz	30 dB min.	30 dB min.	38 dB
4) 2170 to 2300 MHz	25 dB min.	25 dB min.	34 dB
5) 2300 to 2320 MHz	25 dB min.	25 dB min.	33 dB
6) 2320 to 2345 MHz	18 dB min.	18 dB min.	25 dB
7) 2345 to 2365 MHz	10 dB min.	10 dB min.	22 dB
8) 2550 to 2800 MHz	15 dB min.	15 dB min.	22 dB
9) 2800 to 4000 MHz	25 dB min.	25 dB min.	31 dB
10) 4000 to 5000 MHz	30 dB min.	30 dB min.	39 dB
11) 5000 to 6000 MHz	25 dB min.	25 dB min.	34 dB
Ripple Deviation (2400 to 2483.5MHz)	1.5dB max.	1.2dB max.	0.7 dB
VSWR (2400 to 2483.5MHz)	2.4 max.	2.3 max.	2.0
Input/Output Impedance (nominal)	50Ω		
Input Signal Level	10mW (+10dBm), 8000 hours		

SAW FILTER FOR Bluetooth

Murata part number : SAFEA2G44AA0F00

■ Frequency Performance

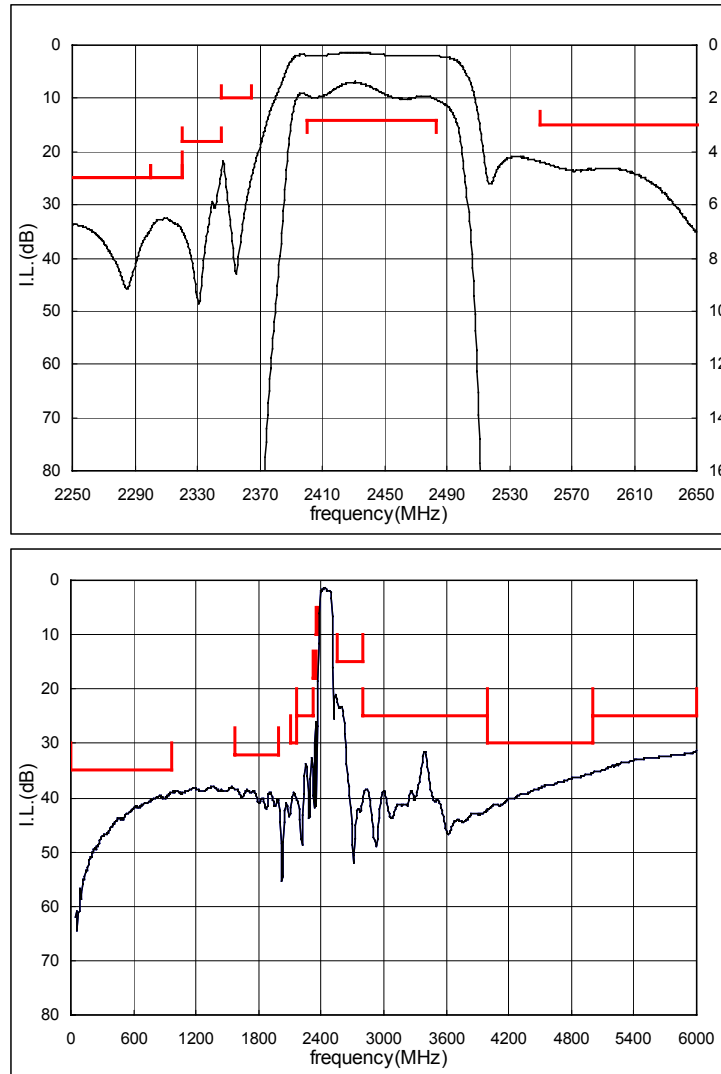

SAW FILTER FOR Bluetooth

Murata part number : SAFEA2G44AA0F00

■ Dimensions of Carrier Tape

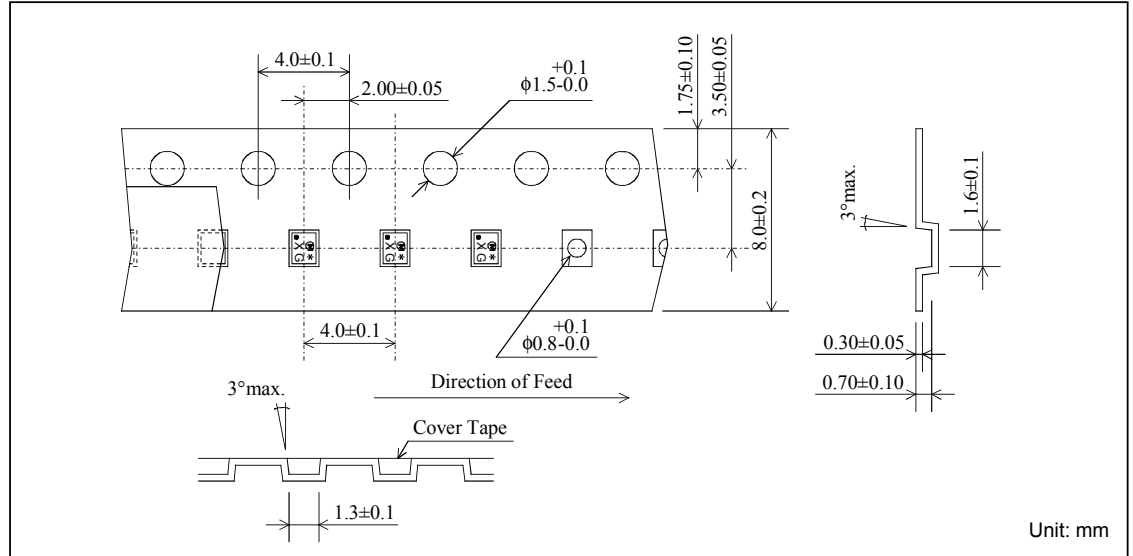

■ Dimensions of Tape

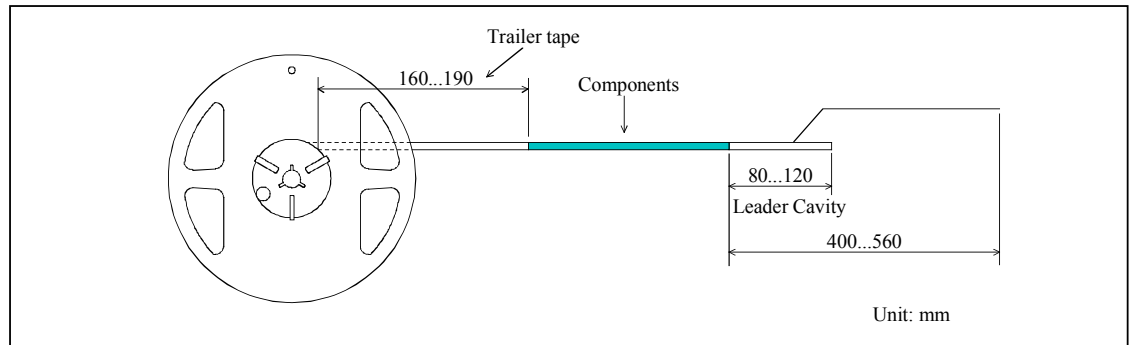

■ Dimensions of Reel

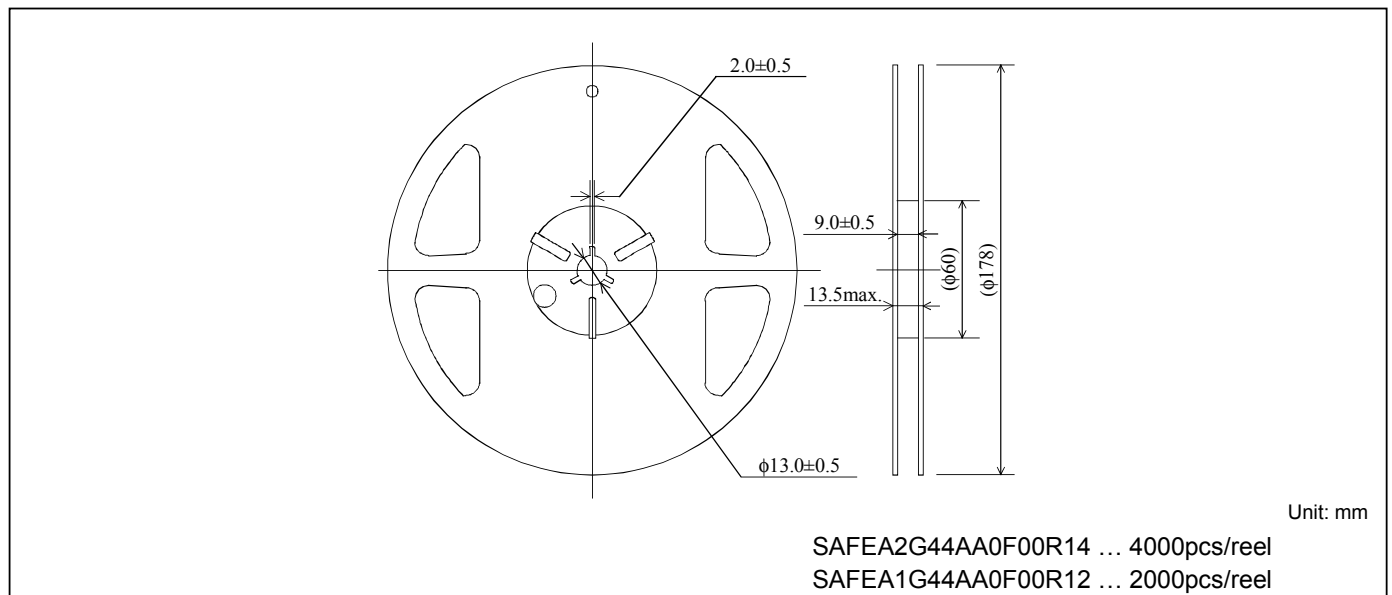

SAW FILTER FOR Bluetooth

Murata part number : SAFEA2G44AA0F00

Recommended Land Pattern

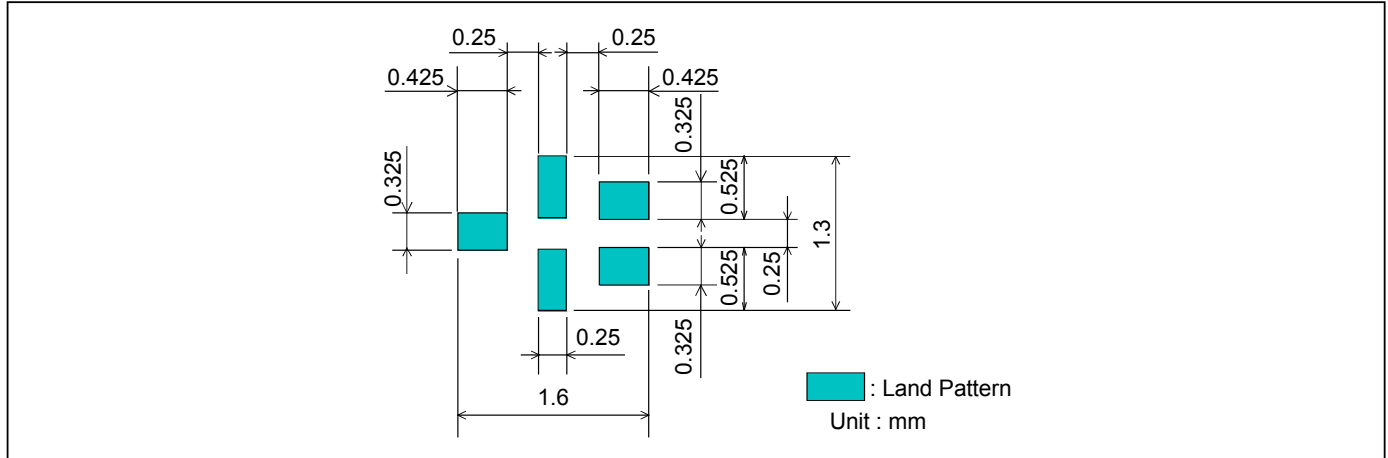

Test Circuit

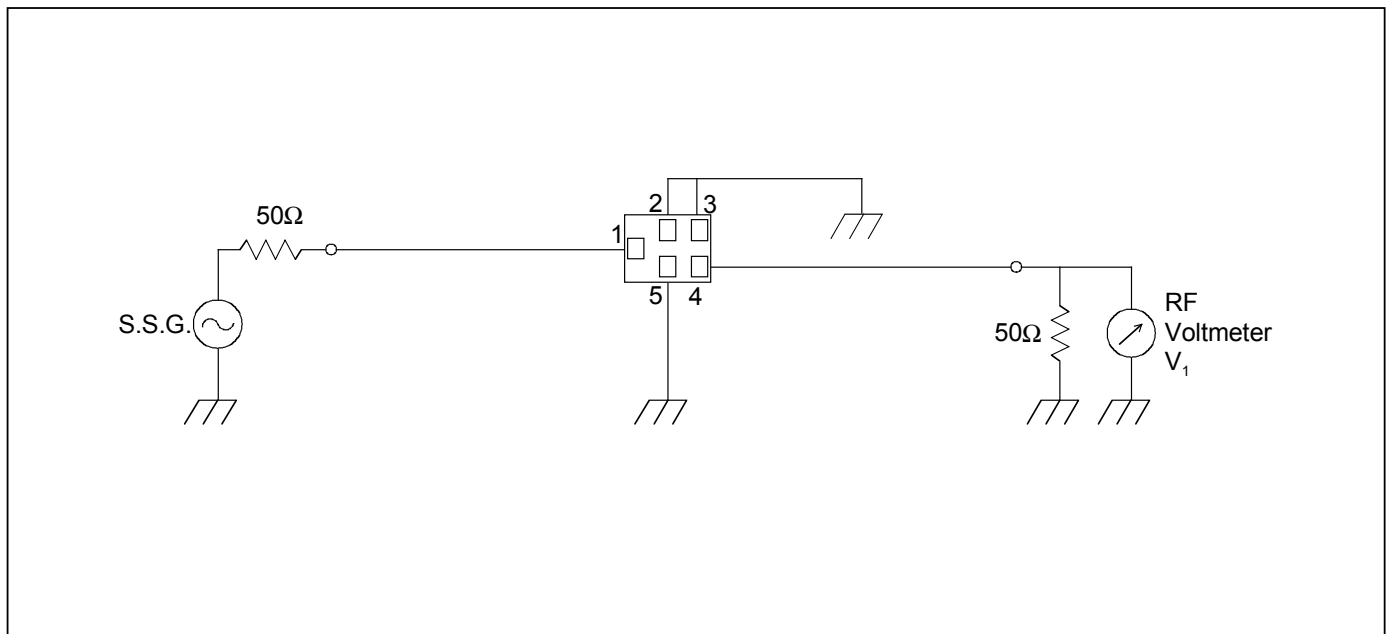

- This PDF Datasheet is downloaded from the website of Murata Manufacturing Co., Ltd. Therefore, it's specifications are subject to change or our products in it may be discontinued without advance notice. Please check with our sales representatives or product engineers before ordering.
- This PDF Datasheet has only typical specifications because there is no space for detailed specifications. Therefore, please approve our product specifications or transact the approval sheet for product specifications before ordering.