

# Notice for TAIYO YUDEN products

Please read this notice before using the TAIYO YUDEN products.

## REMINDERS

- Product information in this catalog is as of October 2008. All of the contents specified herein are subject to change without notice due to technical improvements, etc. Therefore, please check for the latest information carefully before practical application or usage of the Products.

Please note that Taiyo Yuden Co., Ltd. shall not be responsible for any defects in products or equipment incorporating such products, which are caused under the conditions other than those specified in this catalog or individual specification.

- Please contact Taiyo Yuden Co., Ltd. for further details of product specifications as the individual specification is available.
- Please conduct validation and verification of products in actual condition of mounting and operating environment before commercial shipment of the equipment.
- All electronic components or functional modules listed in this catalog are developed, designed and intended for use in general electronics equipment.(for AV, office automation, household, office supply, information service, telecommunications, (such as mobile phone or PC) etc.). Before incorporating the components or devices into any equipment in the field such as transportation,( automotive control, train control, ship control), transportation signal, disaster prevention, medical, public information network (telephone exchange, base station) etc. which may have direct influence to harm or injure a human body, please contact Taiyo Yuden Co., Ltd. for more detail in advance.

Do not incorporate the products into any equipment in fields such as aerospace, aviation, nuclear control, submarine system, military, etc. where higher safety and reliability are especially required.

In addition, even electronic components or functional modules that are used for the general electronic equipment, if the equipment or the electric circuit require high safety or reliability function or performances, a sufficient reliability evaluation check for safety shall be performed before commercial shipment and moreover, due consideration to install a protective circuit is strongly recommended at customer's design stage.

- The contents of this catalog are applicable to the products which are purchased from our sales offices or distributors (so called "TAIYO YUDEN's official sales channel"). It is only applicable to the products purchased from any of TAIYO YUDEN's official sales channel.
- Please note that Taiyo Yuden Co., Ltd. shall have no responsibility for any controversies or disputes that may occur in connection with a third party's intellectual property rights and other related rights arising from your usage of products in this catalog. Taiyo Yuden Co., Ltd. grants no license for such rights.
- Caution for export  
Certain items in this catalog may require specific procedures for export according to "Foreign Exchange and Foreign Trade Control Law" of Japan, "U.S. Export Administration Regulations," and other applicable regulations. Should you have any question or inquiry on this matter, please contact our sales staff.  
Should you have any question or inquiry on this matter, please contact our sales staff.

# 高周波積層チップフィルタ

## HIGH FREQUENCY MULTILAYER CHIP FILTER



OPERATING TEMP. -30~+85°C

リフロー/REFLOW

### 特長 FEATURES

- ・小型・低背
- ・低ロス・高減衰
- ・安定した温度特性

- ・ Compact , Lower profile
- ・ Low loss , High attenuation
- ・ Stable temperature characteristics

### 用途 APPLICATIONS

- ・ Bluetooth® module、無線LAN、デジタルテレビ

- ・ Bluetooth® module, Wireless LAN, Digital TV

### 形名表記法 ORDERING CODE

<b>1</b> デバイスコード FI 高周波フィルタ	<b>3</b> 寸法コード [mm] 212 2.0×1.25 168 1.6×0.8	<b>5</b> 周波数 [MHz] 例 2450 2400~2500 0620 470~770	<b>6</b> 仕様コード 01~ 個別仕様
<b>2</b> 電極コード △ メッキ品 △=スペース	<b>4</b> 種別コード B バンドパスフィルタ L ローパスフィルタ C バランスフィルタ P ダイプレクサ	<b>7</b> 包装 -T テーピング	

F I △ 2 1 2 B 2 4 5 0 2 1 - T

1 2 3 4 5 6 7

<b>1</b> Device code FI Filters for High Frequency	<b>3</b> Dimensions code [mm] 212 2.0×1.25 168 1.6×0.8	<b>5</b> Frequency [MHz] example 2450 2400~2500 0620 470~770	<b>6</b> Spec Code 01~ Individual Spec
<b>2</b> Electrode code △ With Plating △=Blank space	<b>4</b> Special Code B Band Pass Filter L Low Pass Filter C Balance Filter P Diplexer	<b>7</b> Packaging -T Tape & reel	

■ FI 212B Type

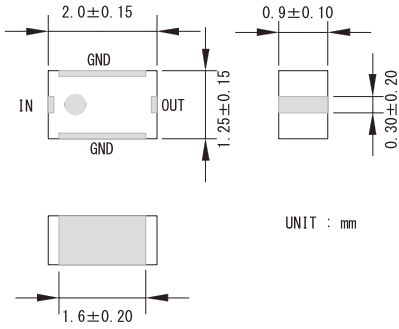

■ FI 212B245021 / FI 212B190223

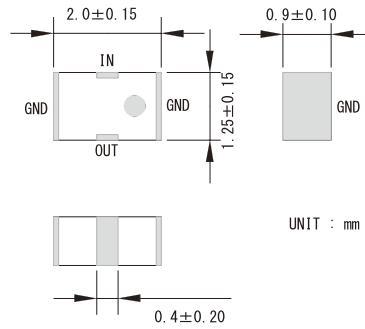

■ FI 212L Type

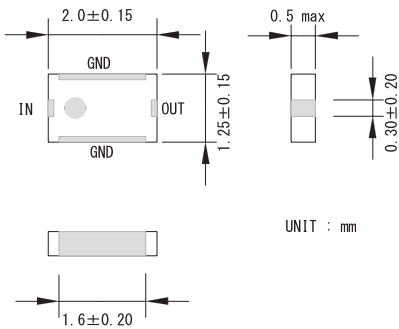

■ FI 168B / L Type

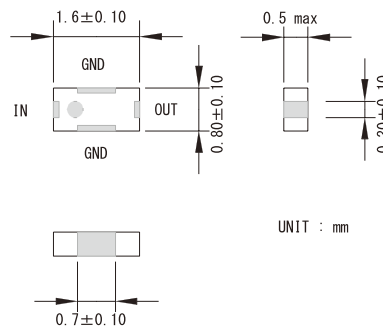

■ FI 212C Type

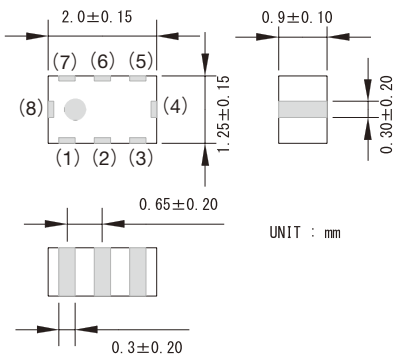

■ FI 212P Type

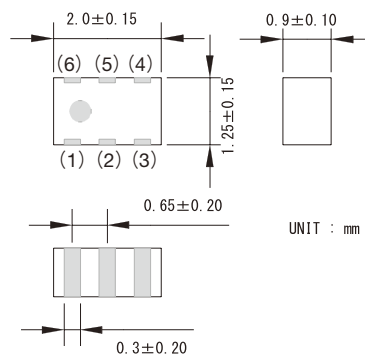

	FI 212C2450XX	FI 212C245041	FI 212C245051	FI 212C259566
(1)	Balanced	Balanced	Balanced	Balanced
(2)	GND	Balanced	GND	GND
(3)	Balanced	GND	Balanced	Balanced
(4)	GND	GND	GND	GND
(5)	Unbalance	NC	Unbalance	Unbalance
(6)	DC	DC	NC	NC or DC
(7)	NC	Unbalance	NC	NC
(8)	GND	GND	GND	GND

	FI 212P245003
(1)	GND
(2)	Common
(3)	GND
(4)	HIGH Band
(5)	GND
(6)	Low Band

セレクトションガイド  
Selection Guide

アイテム一覧  
Part Numbers

特性図  
Electrical Characteristics

梱包  
Packaging

信頼性  
Reliability Data

使用上の注意  
Precautions



etc

## アイテム一覧 Part Numbers

### ■積層バンドパスフィルタ Multi-layer band pass filters

用途 Applications	外形寸法 External dimensions	型名 Ordering code	備考 Notes
2.4GHz W-LAN Bluetooth	2.0×1.25×1.0 max	FI 212B245021	
	1.6×0.8×0.5 max	FI 168B245001	
WiMAX	1.6×0.8×0.5 max	FI 168B259762	
	1.6×0.8×0.5 max	FI 168B259763	
UWB	2.0×1.25×1.0 max	FI 212B396001	WiMedia Band group 1
	2.0×1.25×1.0 max	FI 212B448802	WiMedia Band group 1 TFC 7
PHS	2.0×1.25×1.0 max	FI 212B190223	

### ■積層ローパスフィルタ Multi-layer low pass filters

用途 Applications	外形寸法 External dimensions	型名 Ordering code	備考 Notes
Digital TV	2.0×1.25×0.5 max	FI 212L062002	for ISDB-T
	2.0×1.25×0.5 max	FI 212L062003	for ISDB-T
	2.0×1.25×0.5 max	FI 212L062006	for DMB-TH / DVB-H
	2.0×1.25×0.5 max	FI 212L062007	for DVB-H
	2.0×1.25×0.5 max	FI 212L062008	for DMB-TH / DVB-H
	2.0×1.25×0.5 max	FI 212L062009	for ISDB-T
WiMAX	1.6×0.8×0.45 max	FI 168L062005	Thickness 0.45 mm max
	1.6×0.8×0.45 max	FI 168L259764	Thickness 0.45 mm max

### ■積層バランスフィルタ Multi-layer balance filters

用途 Applications	外形寸法 External dimensions	型名 Ordering code	備考 Notes
Bluetooth	2.0×1.25×1.0 max	FI 212C245031	Conjugated match to CSR BC3
	2.0×1.25×1.0 max	FI 212C245032	Conjugated match to CSR BC4
	2.0×1.25×1.0 max	FI 212C245033	Conjugated match to CSR BC3
	2.0×1.25×1.0 max	FI 212C245035	Conjugated match to CSR BC5
	2.0×1.25×1.0 max	FI 212C245036	Conjugated match to CSR BC5
	2.0×1.25×1.0 max	FI 212C245041	Conjugated match to BRF6150 & BRF6300-BGA
	2.0×1.25×1.0 max	FI 212C245051	Conjugated match to STLC2500C-D
WiMAX	2.0×1.25×0.5 max	FI 212C249566	Thickness 0.5 mm max

### ■積層ダイプレクサ Multi-layer diplexer

用途 Applications	外形寸法 External dimensions	型名 Ordering code	備考 Notes
W-LAN	2.0×1.25×1.0 max	FI 212P245003	

■ FI 212B245021

Pass band frequency	2400-2500 MHz
Insertion loss at pass band	1.8 dB max. (25 deg-C)
	2.1 dB max. (-30 ~ +85 deg-C)
Ripple at pass band	1.0 dB max.
V.S.W.R. at pass band	2.0 max.
Attenuation	25 dB min. (1710 - 1910 MHz)
	20 dB min. (4800 - 5000 MHz)
Impedance	50 ohm

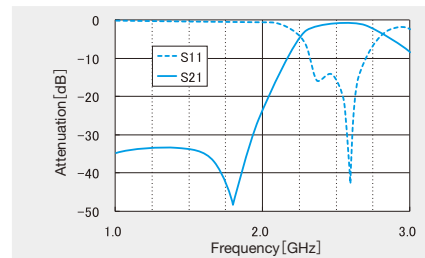

■ FI 168B245001

Pass band frequency	2400 - 2500MHz
Insertion loss at pass band	2.3 dB (25deg-C)
	2.6 dB (-30~+85deg-C)
Ripple at pass band	1.0 dB max.
V.S.W.R. at pass band	2.1 max.
Attenuation	25 dB min. (1710 - 1910MHz)
	20 dB min. (4800 - 5000MHz)
Impedance	50 ohm

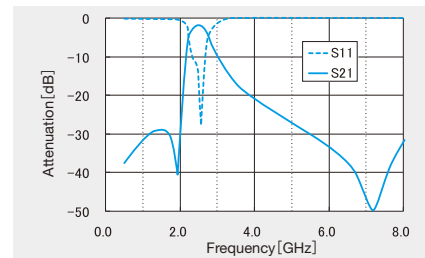

■ FI 168B259762

Pass band frequency	2495 - 2690 MHz
Insertion loss at pass band	2.2 dB max. (25 deg-C)
	2.5 dB max. (-30~+85 deg-C)
Ripple at pass band	1.0 dB max.
V.S.W.R. at pass band	2.1 max.
Attenuation	20dBmin. (824 - 960MHz)
	12dBmin. (1710 - 1990MHz)
	15dBmin. (2110 - 2170MHz)
	10dBmin. (4990 - 5380MHz)
Impedance	50 ohm

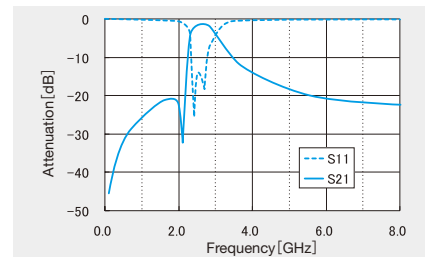

■ FI 168B259763

Pass band frequency	2495 - 2690 MHz
Insertion loss at pass band	2.5 dB max. (25 deg-C)
	2.8 dB max. (-30~+85 deg-C)
Ripple at pass band	1.2 dB max.
V.S.W.R. at pass band	2.2 max.
Attenuation	20 dB min. (100 - 1400MHz)
	35 dB min. (1400 - 1650MHz)
	15 dB min. (4990 - 5380MHz)
Impedance	50 ohm

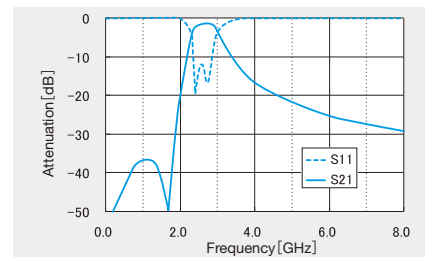

■ FI 212B396001

Pass band frequency	3168 – 4752 MHz
Insertion loss at pass band	2.7 dB max. (25 deg-C)
	3.0 dB max. (-30~+85 deg-C)
Ripple at pass band	2.0 dB max.
V.S.W.R. at pass band	2.5 max.
Attenuation	33 dB min. (900MHz)
	25 dB min. (1500MHz)
	22 dB min. (1900MHz)
	13 dB min. (2500MHz)
10dB min. (5150MHz)	
Impedance	50 ohm

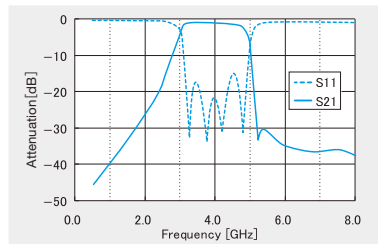

■ FI 212B448802

Pass band frequency	4224 – 4752 MHz
Insertion loss at 4224 – 4488 MHz	2.4 dB max. (25 deg-C)
	2.7 dB max. (-30~+85 deg-C)
Insertion loss at 4488 – 4752 MHz	2.5 dB max. (25 deg-C)
	2.8 dB max. (-30~+85 deg-C)
Ripple at pass band	1.5 dB max.
V.S.W.R. at pass band	2.2 max.
Attenuation	40 dB min. (2400-2500MHz)
	25 dB min. (3300-3600MHz)
	10 dB min. (5158-5850MHz)
Impedance	50 ohm

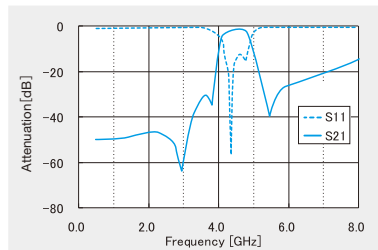

■ FI 212B190223

Pass band frequency	1884-1930MHz
Insertion Loss at 1884-1920MHz	1.7 dB max. (25deg-C)
	2.0 dB max. (-30~+85deg-C)
Insertion Loss at 1920-1930MHz	1.7 dB max. (25deg-C)
	2.0 dB max. (-30~+85deg-C)
Ripple at Pass band	1.0 dB max.
V.S.W.R. at Pass band	2.0 max.
Attenuation	30 dB min. (1420MHz)
	18 dB min. (3768-3860MHz)
Impedance	50 ohm

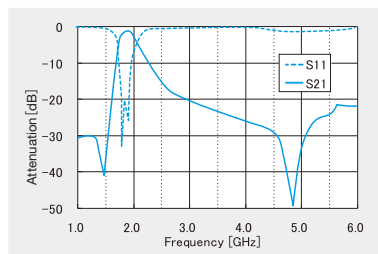

■ FI 212L062002

Pass band frequency	470 – 770 MHz
Insertion loss at 470-600MHz	0.9 dB max. (25 deg-C)
	1.1 dB max. (-30~+85 deg-C)
Insertion loss at 600-710MHz	1.5 dB max. (25 deg-C)
	1.7 dB max. (-30~+85 deg-C)
Insertion loss at 710-770MHz	3.4 dB max. (25 deg-C)
	3.7 dB max. (-30~+85 deg-C)
Ripple at 470 – 710 MHz	1.2 dB max.
V.S.W.R. at 470 – 710 MHz	2.0 max.
Attenuation	25 dB min. (888 – 925 MHz)
	25 dB min. (940 – 960 MHz)
	27 dB min. (1429 – 1453 MHz)
	26 dB min. (1920 – 1980 MHz)
26 dB min. (2400 – 2500 MHz)	
Impedance	50 ohm

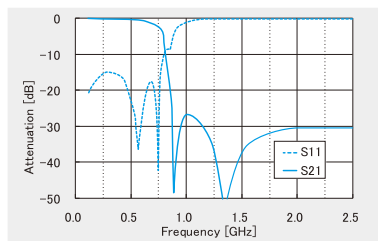

■ FI 212L062003

Pass band frequency	470 – 770 MHz
Insertion loss at	0.7 dB max. (25 deg-C)
470 – 600MHz	0.9 dB max. (-30~+85 deg-C)
Insertion loss at	1.5 dB max. (25 deg-C)
600 – 710MHz	1.7 dB max. (-30~+85 deg-C)
Insertion loss at	3.3 dB max. (25 deg-C)
710 – 770MHz	3.7 dB max. (-30~+85 deg-C)
Ripple at 470 – 710 MHz	1.2 dB max.
V.S.W.R. at 470 – 710 MHz	2.5 max.
Attenuation	15 dB min. (830 – 840 MHz) (25 deg-C)
	11 dB min. (830 – 840 MHz) (-30~+85 deg-C)
	15 dB min. (888 – 925 MHz)
	15 dB min. (940 – 960 MHz)
	7 dB min. (1429 – 1453 MHz)
	8 dB min. (1920 – 1980 MHz)
8 dB min. (2400 – 2500 MHz)	
Impedance	50 ohm

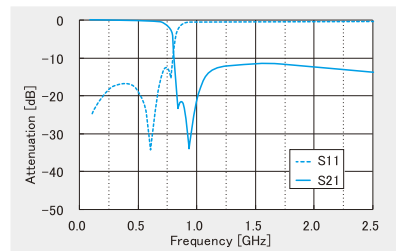

■ FI 212L062006

Pass band frequency	470 – 760 MHz
Insertion loss at	0.7 dB max. (25 deg-C)
470 – 600MHz	0.9 dB max. (-30~+85 deg-C)
Insertion loss at	1.1 dB max. (25 deg-C)
600 – 710MHz	1.3 dB max. (-30~+85 deg-C)
Insertion loss at	1.6 dB max. (25 deg-C)
710 – 760MHz	1.8 dB max. (-30~+85 deg-C)
Ripple at 470 – 710 MHz	1.3 dB max.
V.S.W.R. at 470 – 710 MHz	2.5 max.
Attenuation	15 dB min. (880 – 915 MHz) (25 deg-C)
	11 dB min. (880 – 915 MHz) (-30~+85 deg-C)
	8 dB min. (1710 – 1910 MHz)
Impedance	50 ohm

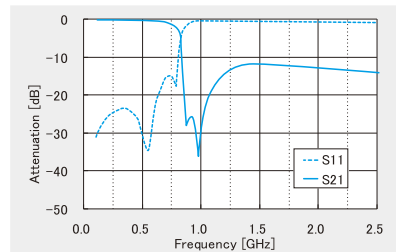

■ FI 212L062007

Pass band frequency	470 – 750 MHz
Insertion loss at	0.8 dB max. (25 deg-C)
470-600MHz	1.0 dB max. (-30~+85 deg-C)
Insertion loss at	1.4 dB max. (25 deg-C)
600-710MHz	1.6 dB max. (-30~+85 deg-C)
Insertion loss at	2.2 dB max. (25 deg-C)
710-750MHz	2.5 dB max. (-30~+85 deg-C)
Ripple at 470 – 710 MHz	1.2 dB max.
V.S.W.R. at 470 – 710 MHz	2.0 max.
Attenuation	25 dB min. (880 – 915 MHz) (25 deg-C)
	23 dB min. (880 – 915 MHz) (-30~+85 deg-C)
	8 dB min. (1500 MHz)
	8 dB min. (1710 MHz)
	8 dB min. (2000 MHz)
	8 dB min. (2500 MHz)
Impedance	50 ohm

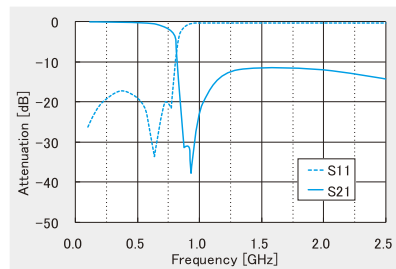

■ FI 212L062008

Pass band frequency	470 – 750 MHz
Insertion loss at	1.0 dB max. (25 deg-C)
470 – 600MHz	1.2 dB max. (-30~+85 deg-C)
Insertion loss at	1.6 dB max. (25 deg-C)
600 – 710MHz	1.8 dB max. (-30~+85 deg-C)
Insertion loss at	2.7 dB max. (25 deg-C)
710 – 750MHz	3.0 dB max. (-30~+85 deg-C)
Ripple at 470 – 710 MHz	1.3 dB max.
V.S.W.R. at 470 – 710 MHz	2.0 max.
Attenuation	25 dB min. (880 – 915 MHz) (25 deg-C)
	23 dB min. (880 – 915 MHz) (-30~+85 deg-C)
	25 dB min. (1710-1990 MHz)
Impedance	50 ohm

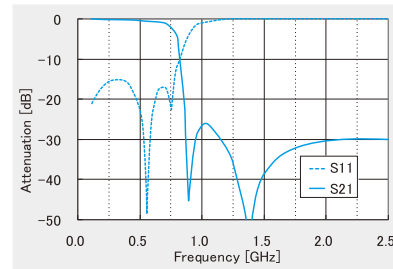

■ FI 212L062009

Pass band frequency	470 – 806 MHz
Insertion loss at	1.6 dB max. (25 deg-C)
470 – 710 MHz	1.8 dB max. (-30~+85 deg-C)
Insertion loss at	2.2 dB max. (25 deg-C)
710 – 750 MHz	2.5 dB max. (-30~+85 deg-C)
Insertion loss at	5.2 dB max. (25 deg-C)
750 – 806 MHz	6.0 dB max. (-30~+85 deg-C)
Ripple at 470 – 710 MHz	1.2 dB max.
V.S.W.R. at 470 – 710 MHz	2.2 max.
Attenuation	20 dB min. (880 – 915 MHz) (25 deg-C)
	17 dB min. (880 – 915 MHz) (-30~+85 deg-C)
	30 dB min. (1710-1910 MHz)
Impedance	50 ohm

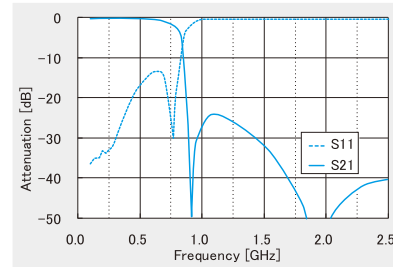

■ FI 168L062005

Pass band frequency	470 – 770 MHz
Insertion loss at	1.2 dB max. (25 deg-C)
470-600MHz	1.3 dB max. (-30~+85 deg-C)
Insertion loss at	2.2 dB max. (25 deg-C)
600-710MHz	2.4 dB max. (-30~+85 deg-C)
Insertion loss at	4.0 dB max. (25 deg-C)
710-770MHz	4.4 dB max. (-30~+85 deg-C)
Ripple at 470 – 710 MHz	1.4 dB max.
V.S.W.R.	2.0 max. (470 – 710 MHz)
	2.5 max. (710 – 770 MHz)
Attenuation	25 dB min. (888 – 925 MHz) (25 deg-C)
	21 dB min. (888 – 925 MHz) (-30~+85 deg-C)
	25 dB min. (940 – 960 MHz)
	27 dB min. (1429 – 1453 MHz)
	26 dB min. (1920 – 1980 MHz)
26 dB min. (2400 – 2500 MHz)	
Impedance	50 ohm

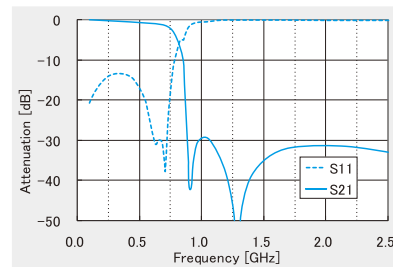

■ FI 168L259764

Pass band frequency	470 – 770 MHz
	2300 – 2700 MHz
Insertion loss at	0.5 dB max. (25 deg-C)
470-770MHz	0.6 dB max. (-30~+85 deg-C)
Insertion loss at	0.5 dB max. (25 deg-C)
2300-2700MHz	0.6 dB max. (-30~+85 deg-C)
Ripple at 470 – 770 MHz	0.3 dB max.
Ripple at 2300 – 2700 MHz	0.3 dB max.
V.S.W.R.at 470 – 770MHz	2.0 max.
V.S.W.R.at 2300 – 2700MHz	2.0 max.
Attenuation	20 dB min. (4600 – 5400 MHz)
	20 dB min. (6900 – 8100 MHz)
Impedance	50 ohm

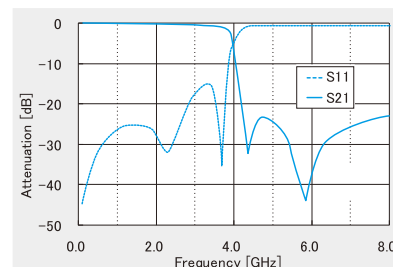



■ FI 212C245031

Pass band frequency	2400-2500MHz
Insertion loss at pass band	3.7 dB (25deg-C) 4.0 dB (-30~+85deg-C)
Ripple at pass band	1.0 dB max.
Single ended port V.S.W.R. at pass band	2.0 max.
Balanced port V.S.W.R. at pass band	2.0 max.
Amplitude Imbalance at pass band	2.0 dB max.
Phase Imbalance at pass band	180 +/-10 deg
Attenuation	35 dB min. (880-960MHz)
	20 dB min. (1710-1990MHz)
	20 dB min. (1990-2170MHz)
	20 dB min. (4800-5000MHz)
Unbalanced Port Impedance	50 ohm
Balanced Port Impedance	Conjugated match to CSR BC3

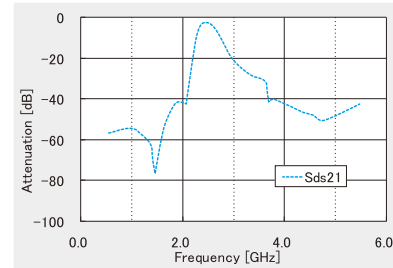
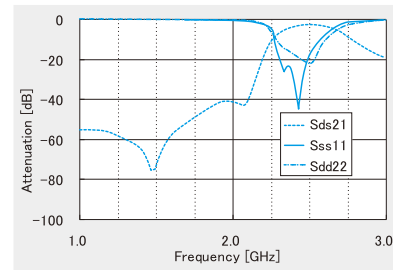

■ FI 212C245032

Pass band frequency	2400-2500MHz
Insertion loss at pass band	3.7 dB (25deg-C) 4.0 dB (-30~+85deg-C)
Ripple at pass band	1.0 dB max.
Single ended port V.S.W.R. at pass band	2.0 max.
Balanced port V.S.W.R. at pass band	2.0 max.
Amplitude Imbalance at pass band	2.0 dB max.
Phase Imbalance at pass band	180 +/- 10 deg
Attenuation	35 dB min. (880-960MHz)
	20 dB min. (1710-1990MHz)
	20 dB min. (1990-2170MHz)
	20 dB min. (4800-5000MHz)
Unbalanced Port Impedance	50 ohm
Balanced Port Impedance	Conjugated match to CSR BC4

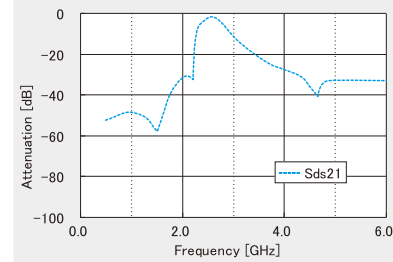
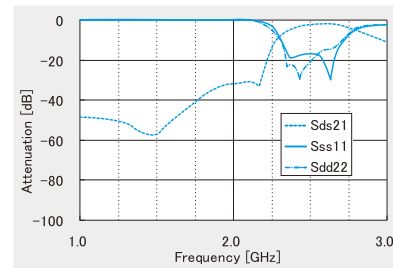

■ FI 212C245033

Pass band frequency	2400-2500MHz
Insertion loss at pass band	2.7 dB (25deg-C) 3.0 dB (-30~+85deg-C)
Ripple at pass band	1.0 dB max.
Single ended port V.S.W.R. at pass band	2.0 max.
Balanced port V.S.W.R. at pass band	2.0 max.
Amplitude Imbalance at pass band	2.0 dB max.
Phase Imbalance at pass band	180 +/- 10 deg
Attenuation	25 dB min. (880-960MHz)
	15 dB min. (1710-1990MHz)
	15 dB min. (1990-2170MHz)
	15 dB min. (4800-5000MHz)
Unbalanced Port Impedance	50 ohm
Balanced Port Impedance	Conjugated match to CSR BC3

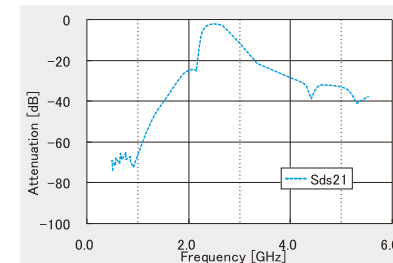
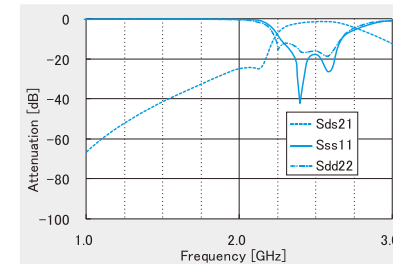

■ FI 212C245035

Pass band frequency	2400-2500MHz
Insertion loss at pass band	3.7 dB (25deg-C) 4.0 dB (-30~+85deg-C)
Ripple at pass band	1.0 dB max.
Single ended port V.S.W.R. at pass band	2.0 max.
Balanced port V.S.W.R. at pass band	2.0 max.
Amplitude Imbalance at pass band	2.0 dB max.
Phase Imbalance at pass band	180 +/- 10 deg
Attenuation	35 dB min. (880-960MHz)
	20 dB min. (1710-1990MHz)
	15 dB min. (1990-2170MHz)
	20 dB min. (4800-5000MHz)
Unbalanced Port Impedance	50 ohm
Balanced Port Impedance	Conjugated match to CSR BC5

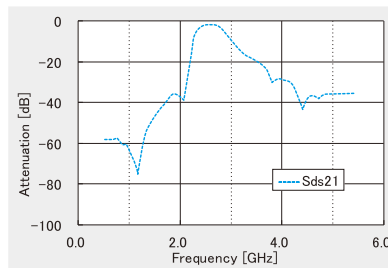
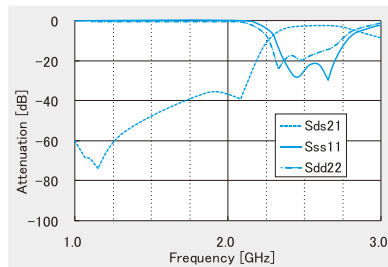

■ FI 212C245036

Pass band frequency	2400-2500MHz
Insertion loss at pass band	3.7 dB (25deg-C) 4.0 dB (-30~+85deg-C)
Ripple at pass band	1.0 dB max.
Single ended port V.S.W.R. at pass band	2.0 max.
Balanced port V.S.W.R. at pass band	2.0 max.
Amplitude Imbalance at pass band	2.0 dB max.
Phase Imbalance at pass band	180 +/- 10 deg
Attenuation	35 dB min. (880-960MHz)
	20 dB min. (1710-1990MHz)
	15 dB min. (1990-2170MHz)
	20 dB min. (4800-5000MHz)
Unbalanced Port Impedance	50 ohm
Balanced Port Impedance	Conjugated match to CSR BC5

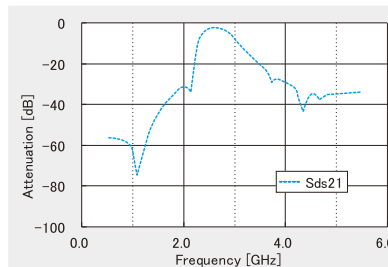
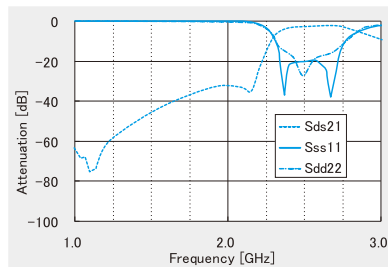

■ FI 212C245041

Pass band frequency	2400-2500MHz
Insertion loss at pass band	3.7 dB (25deg-C) 4.0 dB (-30~+85deg-C)
Ripple at pass band	1.0 dB max.
Single ended port V.S.W.R. at pass band	2.0 max.
Balanced port V.S.W.R. at pass band	2.0 max.
Amplitude Imbalance at pass band	2.0 dB max.
Phase Imbalance at pass band	180 +/- 10 deg
Attenuation	35 dB min. (880-960MHz)
	30 dB min. (1575.42MHz)
	30 dB min. (1710-1990MHz)
	15 dB min. (1990-2170MHz)
	30 dB min. (4800-5000MHz)
	20 dB min. (7200-7500MHz)
Unbalanced Port Impedance	50 ohm
Balanced Port Impedance	Conjugated match to BRF6150&BRF6300-BGA

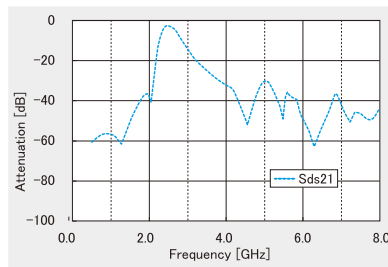
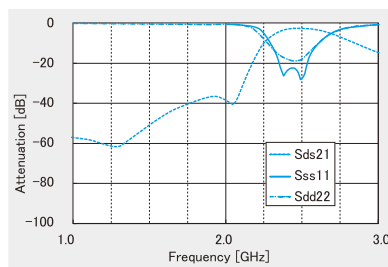

■ FI 212C245051

Pass band frequency	2400-2500MHz
Insertion loss at pass band	3.7 dB (25deg-C)
	4.0 dB (-30~+85deg-C)
Ripple at pass band	1.0 dB max.
Single ended port V.S.W.R. at pass band	2.0 max.
Balanced port V.S.W.R. at pass band	2.0 max.
Amplitude Imbalance at pass band	2.0 dB max.
Phase Imbalance at pass band	180 +/- 10 deg
Attenuation	40 dB min. (824 - 960MHz)
	12 dB min. (1570-1580MHz)
	27 dB min. (1710-1785MHz)
	25 dB min. (1805-1880MHz)
	23 dB min. (1880-1910MHz)
20 dB min. (4800-5000MHz)	
Unbalanced Port Impedance	50 ohm
Balanced Port Impedance	Conjugated match to STLC2500C-D

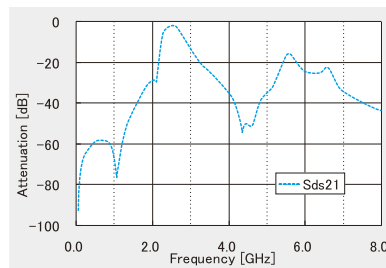
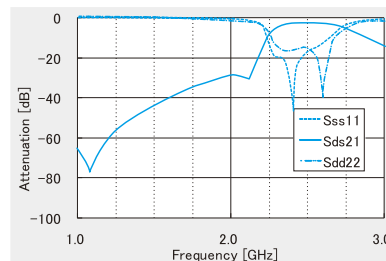

■ FI 212C249566

Pass band frequency	2300-2690MHz
Insertion loss at 2300-2495MHz	2.9 dB max. (25 deg-C)
	3.2 dB max. (-30~+85 deg-C)
Ripple at 2300-2495MHz	1.2 dB max.
Single ended port V.S.W.R. at 2300-2495MHz	2.3 max.
Balanced port V.S.W.R. at 2300-2495MHz	2.3 max.
Amplitude Imbalance at 2300-2495MHz	2.0 dB max.
Phase Imbalance at 2300-2495MHz	180 +/- 12 deg
Insertion loss at 2495-2690MHz	2.3 dB max. (25 deg-C)
	2.6 dB max. (-30~+85 deg-C)
Ripple at 2495-2690MHz	1.0 dB max.
Single ended port V.S.W.R. at 2495-2690MHz	2.3 max.
Balanced port V.S.W.R. at 2495-2690MHz	2.3 max.
Amplitude Imbalance at 2495-2690MHz	2.0 dB max.
Phase Imbalance at 2495-2690MHz	180 +/- 12 deg
Attenuation	40 dB Min. (824-960MHz)
	15 dB Min. (1710-1990MHz)
	20 dB Min. (4900-5850MHz)
Impedance	50 : 100

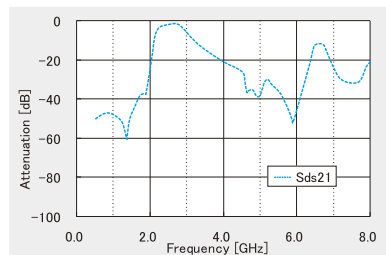
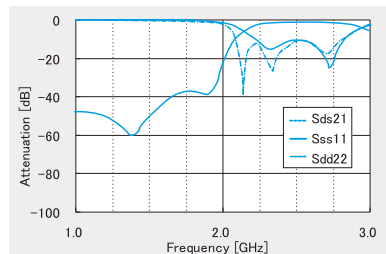

■ FI 212P245003

Low band	
Pass band frequency	2400-2500MHz
Insertion loss at 2400-2500MHz	0.5 dB max. (25 deg-C)
	0.7 dB max. (-30~+85 deg-C)
V.S.W.R.	2.0 dB max.
Attenuation	14 dB min. (4900-5150MHz)
	20 dB min. (5150-5350MHz)
	14 dB min. (5470-5825MHz)
High band	
Pass band frequency 1	4900-5150MHz
Pass band frequency 2	5150-5350MHz
Pass band frequency 3	5470-5825MHz
Insertion loss at pass band 1	0.7 dB max. (25 deg-C)
	0.9 dB max. (-30~+85 deg-C)
Insertion loss at pass band 2	0.6 dB max. (25 deg-C)
	0.8 dB max. (-30~+85 deg-C)
Insertion loss at pass band 3	0.9 dB max. (25 deg-C)
	1.0 dB max. (-30~+85 deg-C)
V.S.W.R.	2.0 dB max. (band-1.-2)
	2.5 dB max. (band-2)
Attenuation	20 dB min. (2400-2500MHz)

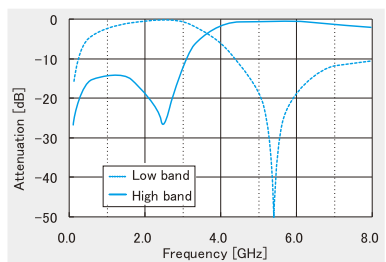

①最小受注単位数 Minimum Quantity

形式 Type	エンボステープ [pcs] Embossed Tape
212B	3000
212L	3000
212C	3000
212P	3000
168B	4000
168L	4000

②テーピング材質 Tape Material

エンボステープ Embossed Tape

紙テープ Card Board Carrier Tape

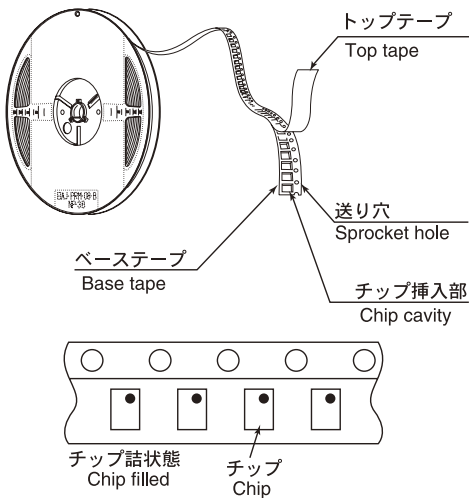

■テーピング梱包 Taped Packaging

形式 (EIA) Type	製品厚み Thickness mm (inch)	標準数量
		Standard quantity [pcs] エンボステープ Embossed tape
212B	0.90typ. (0.035)	3000
212L	0.45typ. (0.018)	3000
212C	0.90typ. (0.035)	3000
212P	0.90typ. (0.035)	3000
168B	0.45typ. (0.018)	4000
168L	0.45typ. (0.018)	4000

③テーピング寸法 Taping Dimensions

エンボステープ (212Bタイプ, 212Cタイプ) 8mm幅  
Embossed tape (0.315 inches wide)

紙テープ (212Lタイプ, 168Bタイプ, 168Lタイプ) 8mm幅  
Paper tape (0.315 inches wide)

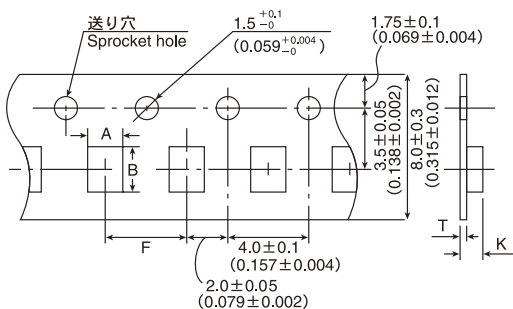

Type (EIA)	チップ挿入部 Chip cavity		挿入ピッチ Insertion Pitch	テープ厚み max Tape Thickness	
	A	B	F	K	T
212B	$1.5 \pm 0.2$	$2.3 \pm 0.2$	4.0 ± 0.1	1.6	0.3
	(0.059 ± 0.008)	(0.091 ± 0.008)			
212L	$1.55 \pm 0.2$	$2.3 \pm 0.2$	(0.157 ± 0.004)	0.65	0.65
	(0.061 ± 0.008)	(0.091 ± 0.008)		(0.026)	(0.026)
212C	$1.55 \pm 0.2$	$2.3 \pm 0.2$	4.0 ± 0.1	1.6	0.3
	(0.061 ± 0.008)	(0.091 ± 0.008)	(0.157 ± 0.004)	(0.063)	(0.012)
212P	$1.55 \pm 0.2$	$2.3 \pm 0.2$	4.0 ± 0.1	1.6	0.3
	(0.061 ± 0.008)	(0.091 ± 0.008)	(0.157 ± 0.004)	(0.063)	(0.012)
168B	$1.00 \pm 0.05$	$1.80 \pm 0.05$	4.0 ± 0.1	0.55	0.55
	(0.039 ± 0.002)	(0.071 ± 0.002)	(0.157 ± 0.004)	(0.022)	(0.022)
168L	$1.00 \pm 0.05$	$1.80 \pm 0.05$	4.0 ± 0.1	0.55	0.55
	(0.039 ± 0.002)	(0.071 ± 0.002)	(0.157 ± 0.004)	(0.022)	(0.022)

Unit : mm (inch)

④リーダー部・空部 Leader and Blank Portion

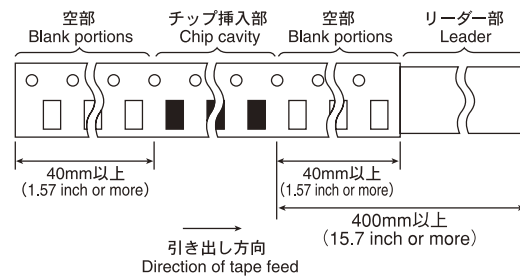

⑤リール寸法 Reel Size

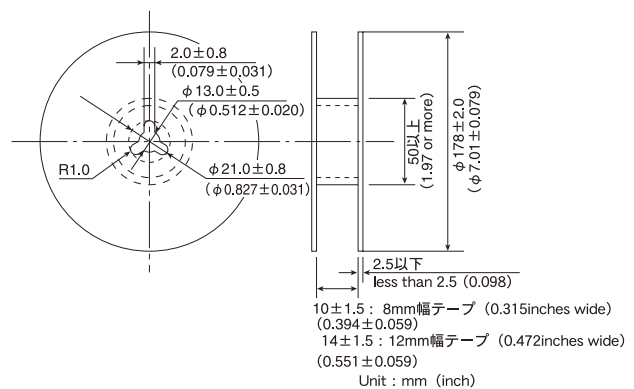

⑥トッテープ強度 Top Tape Strength

トッテープのはがし力は下図矢印方向にて0.1~0.7Nとなります。

The top tape requires a peel-off force of 0.1~0.7N in the direction of the arrow as illustrated below.

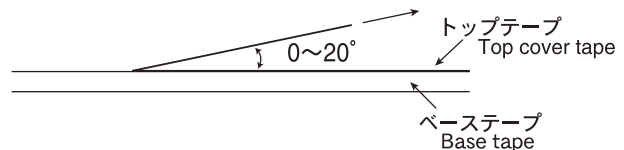

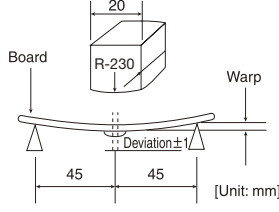
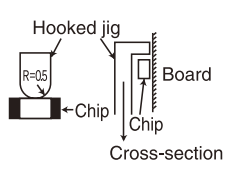
Item	Specified Value	Test Methods and Remarks															
1. Operating Temperature Range	-30~+85°C																
2. Storage Temperature Range	-30~+85°C	※Note : -20 to +35°C in taped packaging															
3. Resistance to Flexure of Substrate	No mechanical damage.	Warp : 2mm Testing board : Glass epoxy-resin substrate Thickness : 0.8mm 															
4. Adhesion of Electrode	Characteristics: shall satisfy the electrical characteristics. Appearance: No significant abnormality.	Applied force : 5N Duration : 10 sec. 															
5. Solderability	75% or more of immersed surface of terminal electrode shall be covered with fresh solder.	Solder temperature : 230±5°C Duration : 4±1sec Preconditioning : Immersion into flux. Immersion and Removal speed : 25 mm/sec.															
6. Resistance to Solder Heat	Characteristics: shall satisfy the electrical characteristics. Appearance: No significant abnormality.	Preheating : 150°C for 2 min. Solder temperature : 260±5°C Duration : 5±0.5sec. Preconditioning : Immersion into flux. Immersion and Removal speed : 25 mm/sec. Recovery : 2 to 3 hrs of recovery under the standard condition after the removal from test chamber															
7. Thermal Shock	Characteristics: shall satisfy the electrical characteristics. Appearance: No significant abnormality.	According to JIS C 0025. Conditions for 1 cycle <table border="1" data-bbox="885 1270 1412 1417"> <thead> <tr> <th>Step</th> <th>Temperature (°C)</th> <th>Duration (min)</th> </tr> </thead> <tbody> <tr> <td>1</td> <td>-40 ± 3°C</td> <td>30 ± 3</td> </tr> <tr> <td>2</td> <td>Room Temperature</td> <td>Within 3</td> </tr> <tr> <td>3</td> <td>85 ± 2°C</td> <td>30 ± 3</td> </tr> <tr> <td>4</td> <td>Room Temperature</td> <td>Within 3</td> </tr> </tbody> </table> Number of cycles : 100 Mounting method : Soldering onto PC board. Recovery : 2 to 3 hrs of recovery under the standard condition after the removal from test chamber.	Step	Temperature (°C)	Duration (min)	1	-40 ± 3°C	30 ± 3	2	Room Temperature	Within 3	3	85 ± 2°C	30 ± 3	4	Room Temperature	Within 3
Step	Temperature (°C)	Duration (min)															
1	-40 ± 3°C	30 ± 3															
2	Room Temperature	Within 3															
3	85 ± 2°C	30 ± 3															
4	Room Temperature	Within 3															
8. Humidity (steady state)	Characteristics: shall satisfy the electrical characteristics. Appearance: No significant abnormality.	Temperature : +40±2°C Humidity : 90 to 95%RH Duration : 96 hrs Recovery : 2 to 3 hrs of recovery under the standard condition after the removal from test chamber.															
9. High temperature life test	Characteristics: shall satisfy the electrical characteristics. Appearance: No significant abnormality.	Temperature: +85±2°C Duration: 96 hrs Recovery : 2 to 3 hrs of recovery under the standard condition after the removal from test chamber.															
10. Low temperature life test	Characteristics: shall satisfy the electrical characteristics. Appearance: No significant abnormality.	Temperature: -40±2°C Duration: 96 hrs Recovery : 2 to 3 hrs of recovery under the standard condition after the removal from test chamber.															

Note on standard condition: "standard condition" referred to herein is defined as follows 5 to 35°C of temperature, 45 to 85% relative humidity and 86 to 106kPa of air pressure.

When there are questions concerning measurement result: In order to provide correlation data, the test shall be conducted under condition of 20±2°C of temperature, 60 to 70% relative humidity and 86 to 106kPa of air pressure.

Unless otherwise specified, all the tests are conducted under the "standard condition".

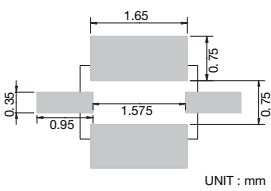
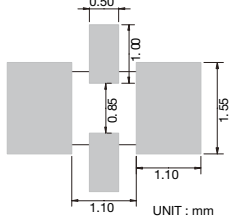
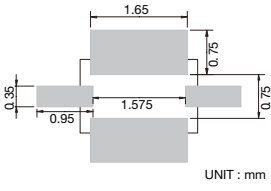
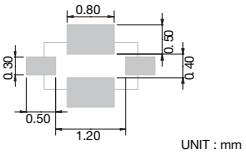
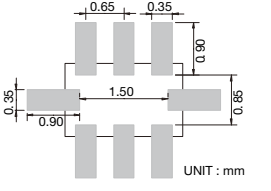
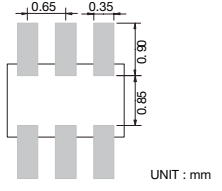
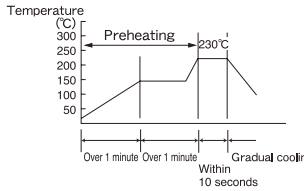
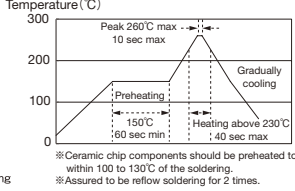
Stages	Precautions	Technical considerations
1. PCB Design	(Land pattern design)	<p>Land pattern dimension examples</p> <div style="display: flex; flex-wrap: wrap;"> <div style="width: 50%;"> <p>■ FI 212B Type</p>  </div> <div style="width: 50%;"> <p>■ FI 212B245021/ FI 212B190223</p>  </div> <div style="width: 50%;"> <p>■ FI 212L Type</p>  </div> <div style="width: 50%;"> <p>■ FI 168B / L Type</p>  </div> <div style="width: 50%;"> <p>■ FI 212C Type</p>  </div> <div style="width: 50%;"> <p>■ FI 212P Type</p>  </div> </div>
2. Soldering		<p>Conditions for Reflow soldering (for reference)</p> <p style="text-align: center;"><u>Reflow Profile</u></p> <div style="display: flex; justify-content: space-around;">   </div> <p>※Ceramic chip components should be preheated to within 100 to 130°C of the soldering.          ※Assured to be reflow soldering for 2 times.</p>
3. Storage conditions	<p>◆Storage</p> <p>1. To maintain the solderability of terminal electrodes and to keep the packaging material in good condition, care must be taken to control temperature and humidity in the storage area.</p> <p>Humidity should especially be kept as low as possible.</p> <ul style="list-style-type: none"> <li>Recommended conditions                     <ul style="list-style-type: none"> <li>Ambient temperature -20~+35°C</li> <li>Humidity Below 60%RH</li> </ul> </li> <li>The ambient temperature must be kept below 30 °C.</li> <li>Even under ideal storage conditions filter electrode solderability decreases as time passes, so filter should be used within 6 months from the time of delivery.</li> <li>The packaging material should be kept where no chlorine or sulfur exists in the air.</li> </ul>	<p>1. If the parts are stocked in a high temperature and humidity environment, problems such as reduced solderability caused by oxidation of terminal electrodes and deterioration of taping/ packaging materials may take place. For this reason, components should be used within 6 months from the time of delivery. If exceeding the above period, please check solderability before using the filter.</p>

■ Please contact of our offices for further details of specifications.  
 All of the standard values listed here are subject to change without notice.  
 Therefore, please check the specifications carefully before use.