

IEC Appliance Inlet C14 with Filter, Fuseholder 1-or 2-pole, optional Voltage Selector (Series-Parallel), "Lock and Shield" Mounting

Standard- or Medical-Filter



GRM4: with shield and line filter



### Description

- Panel Mount:  
Snap-in version from rear-side
- 5 Functions:  
Appliance Inlet Protection class I, Line Switch 2-pole, with or without Fuseholder for fuse-links 5 x 20 mm, with or without voltage selector, Line filter in standard and medical version

- On phase-out, not recommended for new design

### Approvals

- VDE Certificate Number: 118913
- UL File Number: E72928
- CSA File Number: 701867

### Characteristics

- Ultra-compact design  
Time saving "Lock and Shield" snap-in design for rear-panel mounting
- All single elements are already wired
- Fuseholder on the inside of the equipment prevents accidental use of incorrect fuse-links by the user
- Voltage selector for two voltage ranges  
Innovative EMC-shielding with flexible steel segments for an excellent contact to the panel
- Insulation cover on the rear-side
- Qualified for use in equipment according IEC/EN 60950

### Other versions on request

- Panel thickness 1.0 / 2 / 2.5 mm (max.)
- Fuseholder 1-pole
- Line switch 1-pole
- Voltage selector with other marking

### References

#### Weblinks

[General Product Information](#), [Approvals](#), [RoHS](#), [CHINA-RoHS](#), [Mating Connectors](#), [e-Store](#), [SCHURTER-Stock-Check](#), [Distributor-Stock-Check](#), [Accessories](#)

### Technical Data

Ratings IEC	0.5 - 10A @ Ta 40 °C / 250VAC; 50Hz	Appliance-Inlet/-Outlet	C14 acc. to IEC/EN 60320-1, UL 498, CSA C22.2 no. 42 (for cold conditions) pin-temperature 70 °C, 10A, Protection Class 1
Ratings UL/CSA	0.5 - 10A @ Ta 40 °C / 125VAC; 60Hz	Fuseholder	1 or 2 pole, Shocksafe category PC2 acc. to IEC 60127-6, for fuse-links 5 x 20mm
Leakage Current	standard < 0.5mA (250V / 60Hz) medical < 5 µA (250V / 60Hz)	Rated Power Acceptance @ Ta 23 °C	5 x 20: 2W (1 pole)/ 1.6W (2-pole) per pole
Dielectric Strength	> 1.7kVDC between L-N > 2.7kVDC between L/N-PE Test voltage (2sec)	Power Acceptance @ Ta > 23°C	Admissible power acceptance at higher ambient temperature see derating curves
Allowable Operation Temp.	-25 °C to 85 °C	Line Switch	Rocker switch 2-pole, non-illuminated, acc. to IEC 61058-1 <a href="#">Technical details</a>
Climatic Category	25/085/21acc. to, IEC 60068-1	Voltage Selectors	optional, jumper, 2 pos.
Degree of Protection	from front side IP 40 acc. to IEC 60529	Line Filter	Standard and Medical Version, IEC 60939, IEC 60601-1, UL 1283, UL 544, EN 133 200, CSA C22.2 no. 8 <a href="#">Technical details</a>
Protection Class	Suitable for appliances with protection class 1 acc. to IEC 61140	MTBF	> 1'400'000h acc. to MIL-HB-217 F
Terminal	Quick connect terminals 4.8 x 0.8 mm Solder terminal on request Solder terminals for voltage selector		
Panel Thickness s	Snap-in: 1.5 mm (other on request)		
Material: Housing	Thermoplastic, black, UL 94V-0		

## Dimensions

GRM4

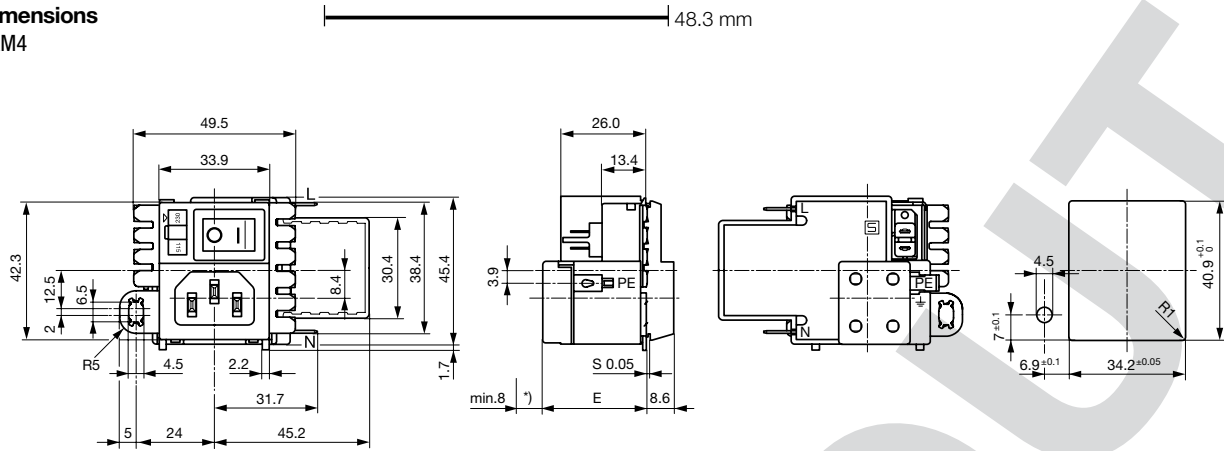

E = 31.7 mm with fuseholder

E = 26.25 mm without fuseholder

\*) Min. space to remove the fuseholder cover

## Dimensions

Step 1

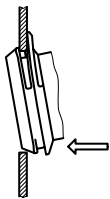

Place the socket in top edge of the panel cut-out.

Step 2



Push the socket upwards.

Step 3

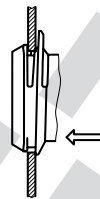

Push the socket forward into the panel cut-out.

Step 4

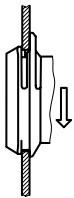

Release the socket. The component is self adjusting.

## Diagrams

Voltage selector

GRM4 Standard version

GRM4 Medical version

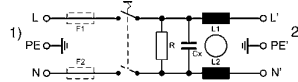
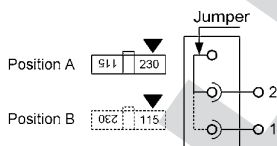

1) Line  
2) Load

**Derating Curves**

1-pole

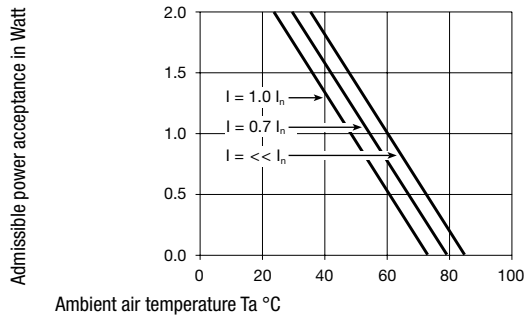

2-pole

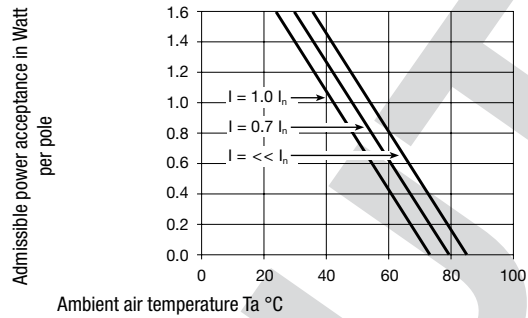

**Attenuation loss**

..... 0.1/100Ω differential mode ..... 100/0.1Ω differential mode - - - differential mode \_\_\_\_ common mode

Standard version

0.5 A

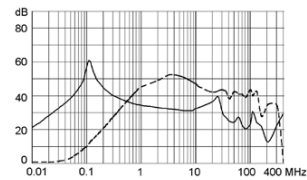

1 A

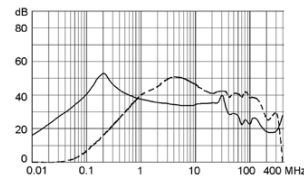

3 A

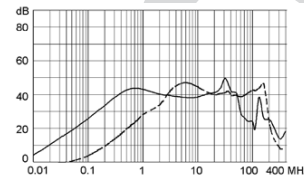

6 A

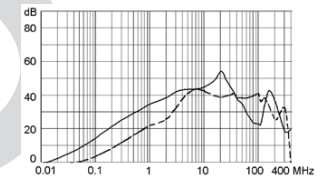

10 A

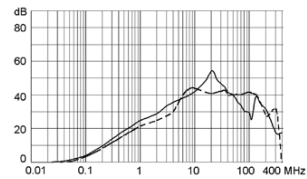

Medical version (M5)

0.5 A

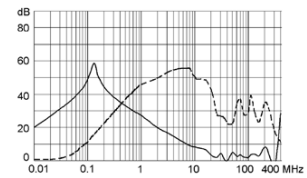

1 A

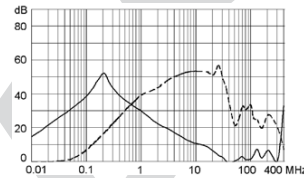

3 A

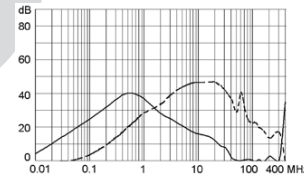

6 A

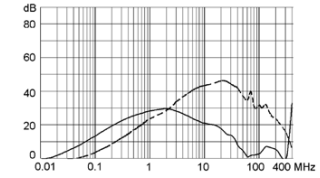

10 A

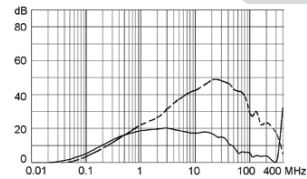

## Variants

Basic version:

- Marking of the voltage selector 115/230
- with housing and cover on the rear-side

Rated Current [A]	Filter-Type	Fuseholder	Line Switch	Voltage Selectors	Order Number
6	Standard Version	-	1-pole	●	GRM4.4401.013
6	Standard Version	-	1-pole	●	GRM4.4401.013.C
0.5	Standard Version	-	2-pole		GRM4.4102.013
0.5	Standard Version	-	2-pole	●	GRM4.4102.013.C
0.5	Standard Version	-	2-pole	●	GRM4.4102.123
0.5	Standard Version	-	2-pole	●	GRM4.4102.123.C
1	Standard Version	-	2-pole	●	GRM4.4202.013
1	Standard Version	-	2-pole	●	GRM4.4202.013.C
1	Standard Version	-	2-pole	●	GRM4.4202.123
1	Standard Version	-	2-pole	●	GRM4.4202.123.C
1	Standard Version	-	2-pole	●	GRM4.4202.124.C
3	Standard Version	-	2-pole	●	GRM4.4302.013
3	Standard Version	-	2-pole	●	GRM4.4302.013.C
3	Standard Version	-	2-pole	●	GRM4.4302.123
3	Standard Version	-	2-pole	●	GRM4.4302.123.C
6	Standard Version	-	2-pole	●	GRM4.4402.013
6	Standard Version	-	2-pole	●	GRM4.4402.013.C
6	Standard Version	-	2-pole	●	GRM4.4402.123
6	Standard Version	-	2-pole	●	GRM4.4402.123.C
10	Standard Version	-	2-pole	●	GRM4.4502.013
10	Standard Version	-	2-pole	●	GRM4.4502.013.C
10	Standard Version	-	2-pole	●	GRM4.4502.123
10	Standard Version	-	2-pole	●	GRM4.4502.123.C
0.5	Standard Version	2-pole	2-pole	●	GRM4.4122.013
0.5	Standard Version	2-pole	2-pole	●	GRM4.4122.013.C
0.5	Standard Version	2-pole	2-pole	●	GRM4.4122.123
0.5	Standard Version	2-pole	2-pole	●	GRM4.4122.123.C
1	Standard Version	2-pole	2-pole	●	GRM4.4222.013
1	Standard Version	2-pole	2-pole	●	GRM4.4222.013.C
1	Standard Version	2-pole	2-pole	●	GRM4.4222.123
1	Standard Version	2-pole	2-pole	●	GRM4.4222.123.C
3	Standard Version	2-pole	2-pole	●	GRM4.4322.013
3	Standard Version	2-pole	2-pole	●	GRM4.4322.013.C
3	Standard Version	2-pole	2-pole	●	GRM4.4322.123
3	Standard Version	2-pole	2-pole	●	GRM4.4322.123.C
6	Standard Version	2-pole	2-pole	●	GRM4.4422.013
6	Standard Version	2-pole	2-pole	●	GRM4.4422.013.C
6	Standard Version	2-pole	2-pole	●	GRM4.4422.123
6	Standard Version	2-pole	2-pole	●	GRM4.4422.123.C
10	Standard Version	2-pole	2-pole	●	GRM4.4522.013
10	Standard Version	2-pole	2-pole	●	GRM4.4522.013.C
10	Standard Version	2-pole	2-pole	●	GRM4.4522.123
10	Standard Version	2-pole	2-pole	●	GRM4.4522.123.C
0.5	Medical Version (M5)	-	2-pole	●	GRM4.5102.013
0.5	Medical Version (M5)	-	2-pole	●	GRM4.5102.013.C
0.5	Medical Version (M5)	-	2-pole	●	GRM4.5102.123
0.5	Medical Version (M5)	-	2-pole	●	GRM4.5102.123.C
1	Medical Version (M5)	-	2-pole	●	GRM4.5202.013
1	Medical Version (M5)	-	2-pole	●	GRM4.5202.013.C
1	Medical Version (M5)	-	2-pole	●	GRM4.5202.123
1	Medical Version (M5)	-	2-pole	●	GRM4.5202.123.C
3	Medical Version (M5)	-	2-pole	●	GRM4.5302.013
3	Medical Version (M5)	-	2-pole	●	GRM4.5302.013.C

Rated Current [A]	Filter-Type	Fuseholder	Line Switch	Voltage Selectors	Order Number
3	Medical Version (M5)	-	2-pole	●	GRM4.5302.123
3	Medical Version (M5)	-	2-pole	●	GRM4.5302.123.C
6	Medical Version (M5)	-	2-pole	●	GRM4.5402.013
6	Medical Version (M5)	-	2-pole	●	GRM4.5402.013.C
6	Medical Version (M5)	-	2-pole	●	GRM4.5402.123
6	Medical Version (M5)	-	2-pole	●	GRM4.5402.123.C
10	Medical Version (M5)	-	2-pole	●	GRM4.5502.013
10	Medical Version (M5)	-	2-pole	●	GRM4.5502.013.C
10	Medical Version (M5)	-	2-pole	●	GRM4.5502.123
10	Medical Version (M5)	-	2-pole	●	GRM4.5502.123.C
3	Medical Version (M5)	2-pole	2-pole		GRM4.5322.013.C
6	Medical Version (M5)	2-pole	2-pole		GRM4.5422.013.C
10	Medical Version (M5)	2-pole	2-pole		GRM4.5522.013.C
0.5	Medical Version (M5)	2-pole	2-pole	●	GRM4.5122.013
0.5	Medical Version (M5)	2-pole	2-pole	●	GRM4.5122.013.C
0.5	Medical Version (M5)	2-pole	2-pole	●	GRM4.5122.123
0.5	Medical Version (M5)	2-pole	2-pole	●	GRM4.5122.123.C
1	Medical Version (M5)	2-pole	2-pole	●	GRM4.5222.013
1	Medical Version (M5)	2-pole	2-pole	●	GRM4.5222.013.C
1	Medical Version (M5)	2-pole	2-pole	●	GRM4.5222.123
1	Medical Version (M5)	2-pole	2-pole	●	GRM4.5222.123.C
3	Medical Version (M5)	2-pole	2-pole	●	GRM4.5322.013
3	Medical Version (M5)	2-pole	2-pole	●	GRM4.5322.123
3	Medical Version (M5)	2-pole	2-pole	●	GRM4.5322.123.C
6	Medical Version (M5)	2-pole	2-pole	●	GRM4.5422.013
6	Medical Version (M5)	2-pole	2-pole	●	GRM4.5422.123
6	Medical Version (M5)	2-pole	2-pole	●	GRM4.5422.123.C
10	Medical Version (M5)	2-pole	2-pole	●	GRM4.5522.013
10	Medical Version (M5)	2-pole	2-pole	●	GRM4.5522.123
10	Medical Version (M5)	2-pole	2-pole	●	GRM4.5522.123.C
10	Standard and Medical Version	1 or 2 pole	2-pole	●	GRM4.4202.124
10	Standard and Medical Version	1 or 2 pole	2-pole	●	GRM4.4402.124
10	Standard and Medical Version	1 or 2 pole	2-pole	●	GRM4.4402.124.C
10	Standard and Medical Version	1 or 2 pole	2-pole	●	GRM4.4522.014
10	Standard and Medical Version	1 or 2 pole	2-pole	●	GRM4.4522.014.C

**Packaging unit** 120 Pcs

### Mating Outlets/Connectors

Category / Description

[Appliance Outlet Overview complete](#)



IEC Appliance Outlet F, Screw-on Mounting, Front Side, Solder Terminal	4787
IEC Appliance Outlet F, Snap-in Mounting, Front Side, Solder or Quick-connect Terminal	4788
IEC Appliance Outlet F or H, Screw-on Mounting, Front Side, Solder, PCB or Quick-connect Terminal	5091
IEC Appliance Outlet F or H, Screw-on Mounting, Front Side, Solder or Quick-connect Terminal	5092

[Appliance Outlet further types to GRM4](#)

## ConnectorOverview complete



IEC Connector C15, Rewireable, Straight	0101
IEC Connector C15A, Rewireable, Straight	0102
IEC Connector C15A, Rewireable, Straight	0102-G
IEC Connector C15A, Rewireable, Angled	0112
IEC Connector C13, Rewireable, Angled	4012
<a href="#">Connector further types to GRM4</a>	...

## Power CordOverview complete



Power Cord with IEC Connector C13, Angled	0311
Power Cord with IEC Connector C13, Angled	3011
Power Cord with IEC Connector C13, Angled	3012
Power Cord with IEC Connector C13, Angled	3013
Power Cord with IEC Connector C13	3020
<a href="#">Power Cord further types to GRM4</a>	...

PHASE-O