

Three quadrant triacs guaranteed commutation

BTA204 series D, E and F

GENERAL DESCRIPTION

Passivated guaranteed commutation triacs in a plastic envelope, intended for use in motor control circuits or with other highly inductive loads. These devices balance the requirements of commutation performance and gate sensitivity. The "sensitive gate" E series and "logic level" D series are intended for interfacing with low power drivers, including micro controllers.

QUICK REFERENCE DATA

SYMBOL	PARAMETER	MAX.	MAX.	UNIT
V_{DRM}	Repetitive peak off-state voltages	600D 600E 600F 600	- 800E 800	V
$I_{\text{T(RMS)}}$	RMS on-state current	4	4	A
I_{TSM}	Non-repetitive peak on-state current	25	25	A

PINNING - TO220AB

PIN	DESCRIPTION
1	main terminal 1
2	main terminal 2
3	gate
tab	main terminal 2

PIN CONFIGURATION

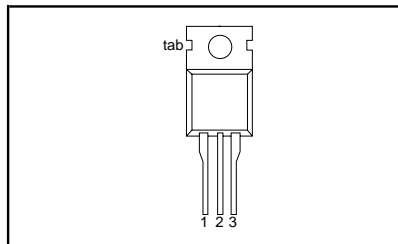

SYMBOL

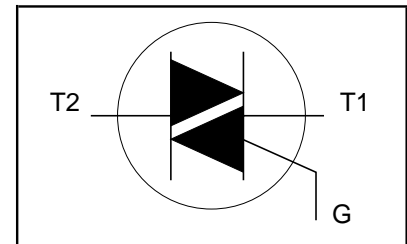

LIMITING VALUES

Limiting values in accordance with the Absolute Maximum System (IEC 134).

SYMBOL	PARAMETER	CONDITIONS	MIN.	MAX.		UNIT
				-600 600 ¹	-800 800	
V_{DRM}	Repetitive peak off-state voltages		-	-600 600 ¹	-800 800	V
$I_{\text{T(RMS)}}$	RMS on-state current	full sine wave; $T_{\text{mb}} \leq 107^\circ\text{C}$	-	4		A
I_{TSM}	Non-repetitive peak on-state current	full sine wave; $T_{\text{j}} = 25^\circ\text{C}$ prior to surge	-	25		A
I^2t	I^2t for fusing	$t = 20\text{ ms}$	-	27		A
di_{T}/dt	Repetitive rate of rise of on-state current after triggering	$t = 16.7\text{ ms}$	-	3.1		A ² s
I_{GM}	Peak gate current	$t = 10\text{ ms}$	-	100		A/ μs
P_{GM}	Peak gate power	$I_{\text{TM}} = 6\text{ A}; I_{\text{G}} = 0.2\text{ A}; di_{\text{G}}/dt = 0.2\text{ A}/\mu\text{s}$	-	2		A
$P_{\text{G(AV)}}$	Average gate power	over any 20 ms period	-	5		W
T_{stg}	Storage temperature		-40	150		$^\circ\text{C}$
T_{j}	Operating junction temperature		-	125		$^\circ\text{C}$

¹ Although not recommended, off-state voltages up to 800V may be applied without damage, but the triac may switch to the on-state. The rate of rise of current should not exceed 6 A/ μs .

Three quadrant triacs guaranteed commutation

BTA204 series D, E and F

THERMAL RESISTANCES

SYMBOL	PARAMETER	CONDITIONS	MIN.	TYP.	MAX.	UNIT
$R_{th\ j-mb}$	Thermal resistance junction to mounting base	full cycle	-	-	3.0	K/W
$R_{th\ j-a}$	Thermal resistance junction to ambient	half cycle in free air	-	60	3.7	K/W

STATIC CHARACTERISTICS

$T_j = 25\text{ }^\circ\text{C}$ unless otherwise stated

SYMBOL	PARAMETER	CONDITIONS	MIN.	TYP.	MAX.			UNIT
					...D	...E	...F	
BTA204-								
I_{GT}	Gate trigger current ²	$V_D = 12\text{ V}$; $I_T = 0.1\text{ A}$ T2+ G+ T2+ G- T2- G-	-	-	5	10	25	mA
I_L	Latching current	$V_D = 12\text{ V}$; $I_{GT} = 0.1\text{ A}$ T2+ G+ T2+ G- T2- G-	-	-	5	10	25	mA
I_H	Holding current	$V_D = 12\text{ V}$; $I_{GT} = 0.1\text{ A}$ T2+ G+ T2+ G- T2- G-	-	-	6	12	20	mA
V_T	On-state voltage	$I_T = 5\text{ A}$	-	1.4	1.7			V
V_{GT}	Gate trigger voltage	$V_D = 12\text{ V}$; $I_T = 0.1\text{ A}$ $V_D = 400\text{ V}$; $I_T = 0.1\text{ A}$; $T_j = 125\text{ }^\circ\text{C}$	-	0.7	1.5			V
I_D	Off-state leakage current	$V_D = V_{DRM(max)}$; $T_j = 125\text{ }^\circ\text{C}$	0.25	0.4	-			V
			-	0.1	0.5			mA

DYNAMIC CHARACTERISTICS

$T_j = 25\text{ }^\circ\text{C}$ unless otherwise stated

SYMBOL	PARAMETER	CONDITIONS	MIN.			TYP.	MAX.	UNIT
			...D	...E	...F			
BTA204-								
dV_D/dt	Critical rate of rise of off-state voltage	$V_{DM} = 67\% V_{DRM(max)}$; $T_j = 125\text{ }^\circ\text{C}$; exponential waveform; gate open circuit	20	30	50	-	-	V/ μs
di_{com}/dt	Critical rate of change of commutating current	$V_{DM} = 400\text{ V}$; $T_j = 125\text{ }^\circ\text{C}$; $I_{T(RMS)} = 4\text{ A}$; $dV_{com}/dt = 10\text{ V}/\mu\text{s}$; gate open circuit	1.1	2.1	3.0	-	-	A/ms
di_{com}/dt	Critical rate of change of commutating current	$V_{DM} = 400\text{ V}$; $T_j = 125\text{ }^\circ\text{C}$; $I_{T(RMS)} = 4\text{ A}$; $dV_{com}/dt = 0.1\text{ V}/\mu\text{s}$; gate open circuit	4.5	8.0	15	-	-	A/ms
t_{gt}	Gate controlled turn-on time	$I_{TM} = 12\text{ A}$; $V_D = V_{DRM(max)}$; $I_G = 0.1\text{ A}$; $di_G/dt = 5\text{ A}/\mu\text{s}$	-	-	-	2	-	μs

² Device does not trigger in the T2-, G+ quadrant.

Three quadrant triacs guaranteed commutation

BTA204 series D, E and F

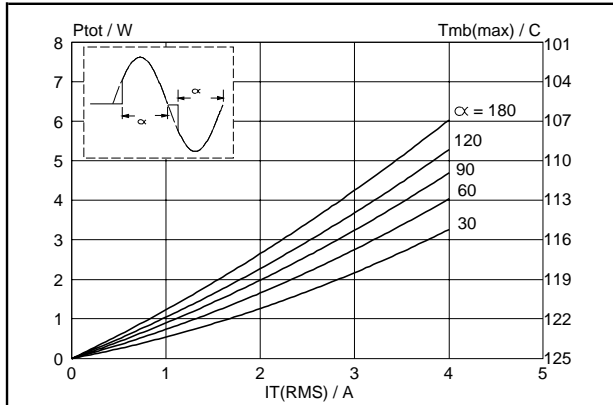

Fig.1. Maximum on-state dissipation, P_{tot} , versus rms on-state current, $I_{T(RMS)}$, where $\alpha =$ conduction angle.

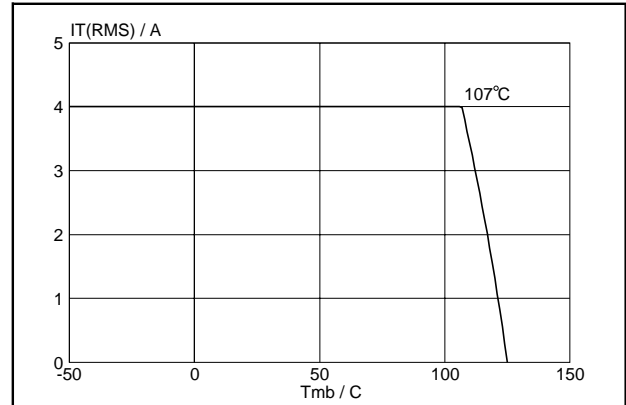

Fig.4. Maximum permissible rms current $I_{T(RMS)}$, versus mounting base temperature T_{mb} .

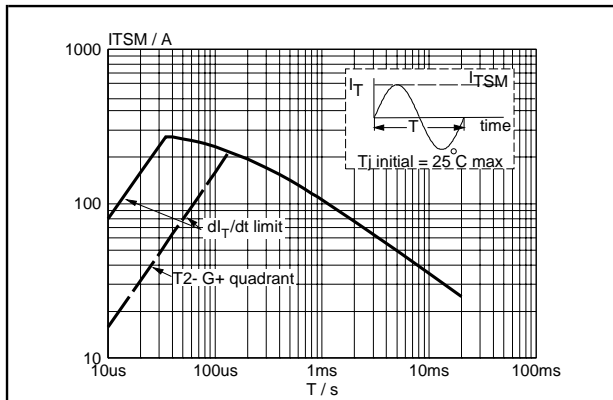

Fig.2. Maximum permissible non-repetitive peak on-state current I_{TSM} , versus pulse width t_p , for sinusoidal currents, $t_p \leq 20$ ms.

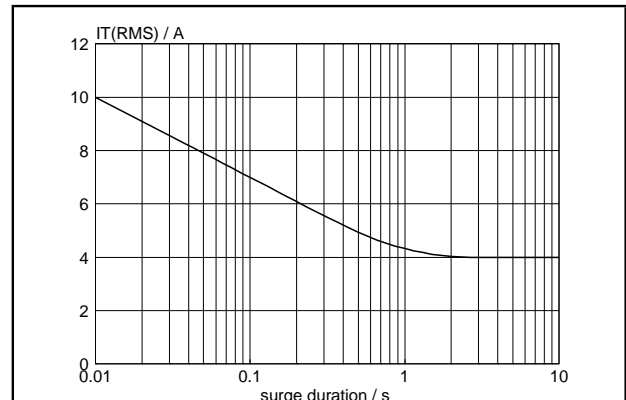

Fig.5. Maximum permissible repetitive rms on-state current $I_{T(RMS)}$, versus surge duration, for sinusoidal currents, $f = 50$ Hz; $T_{mb} \leq 107$ C.

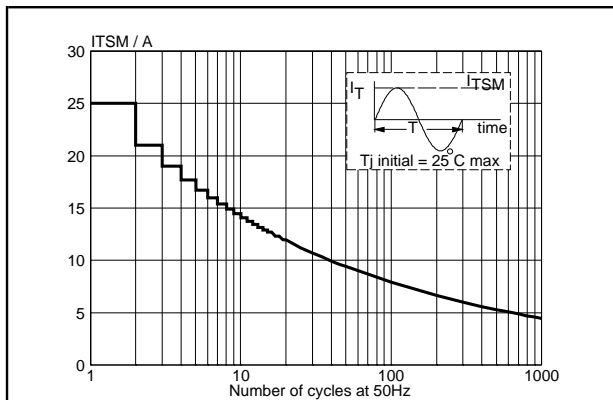

Fig.3. Maximum permissible non-repetitive peak on-state current I_{TSM} , versus number of cycles, for sinusoidal currents, $f = 50$ Hz.

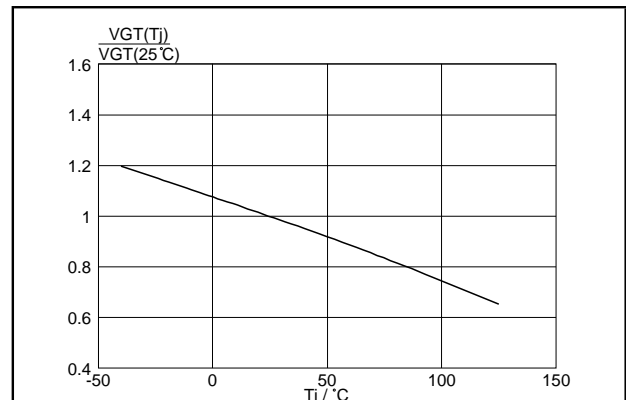
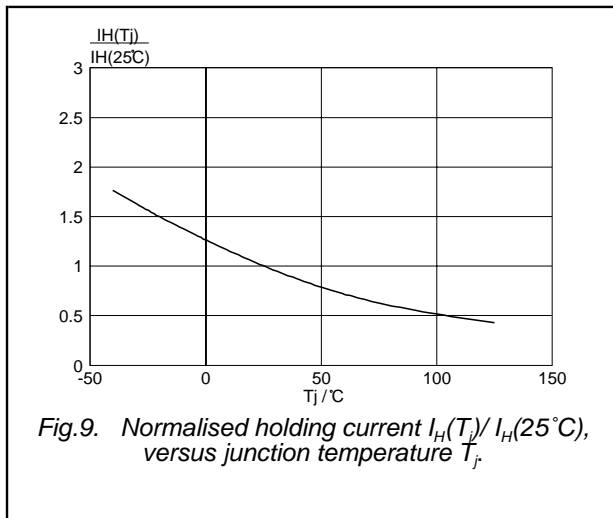
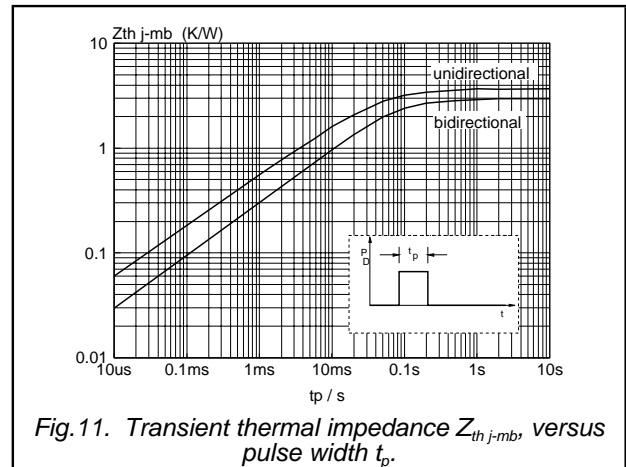
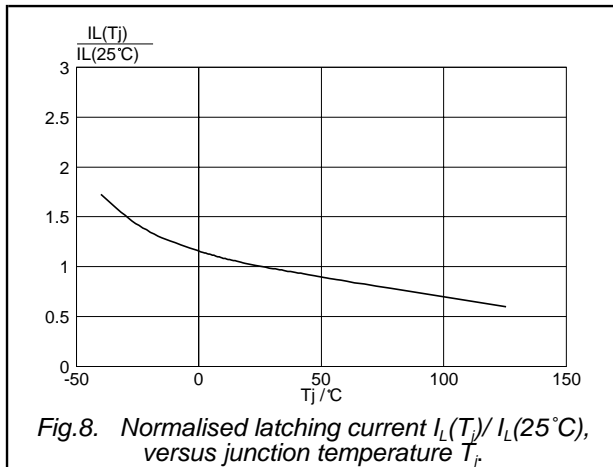
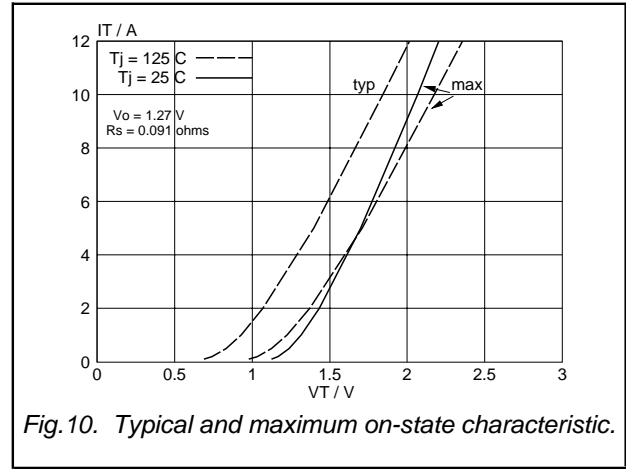
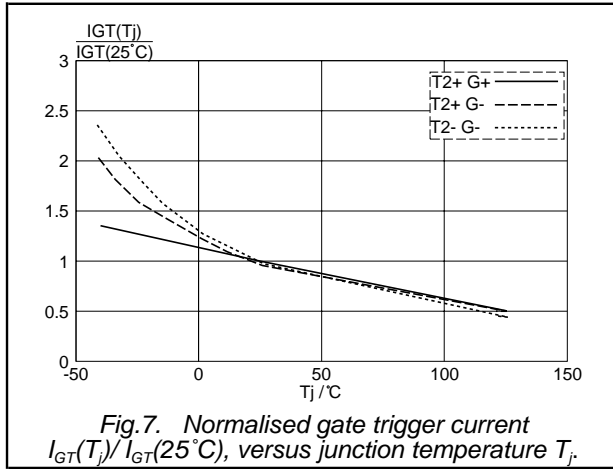

Fig.6. Normalised gate trigger voltage $V_{GT}(T_j) / V_{GT}(25 C)$, versus junction temperature T_j .

Three quadrant triacs
guaranteed commutation

BTA204 series D, E and F



Three quadrant triacs
guaranteed commutation

BTA204 series D, E and F

MECHANICAL DATA

Dimensions in mm

Net Mass: 2 g

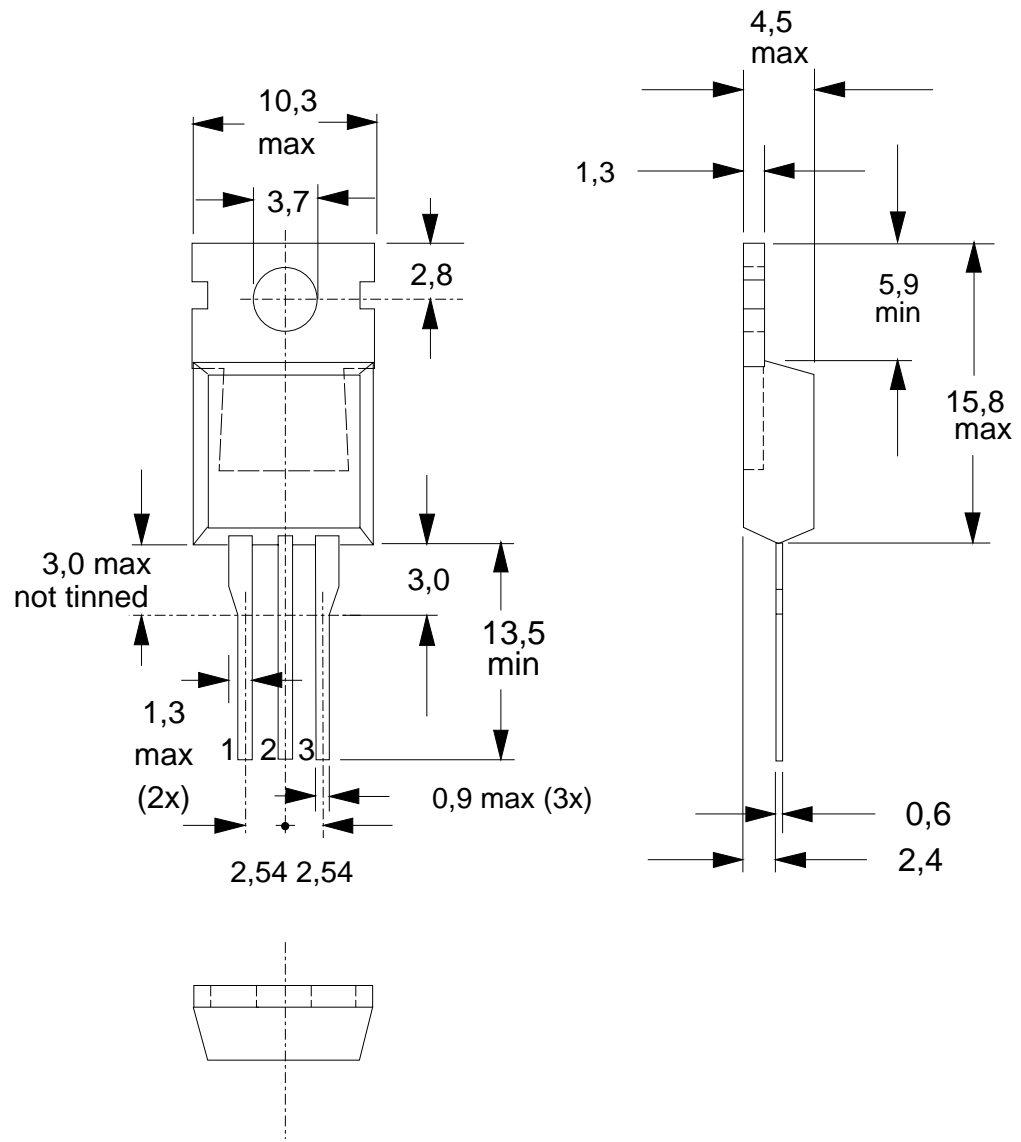

Fig.12. SOT78 (TO220AB). pin 2 connected to mounting base.

Notes

1. Refer to mounting instructions for SOT78 (TO220) envelopes.
2. Epoxy meets UL94 V0 at 1/8".

Three quadrant triacs guaranteed commutation

BTA204 series D, E and F

DEFINITIONS

DATA SHEET STATUS		
DATA SHEET STATUS ³	PRODUCT STATUS ⁴	DEFINITIONS
Objective data	Development	This data sheet contains data from the objective specification for product development. Philips Semiconductors reserves the right to change the specification in any manner without notice
Preliminary data	Qualification	This data sheet contains data from the preliminary specification. Supplementary data will be published at a later date. Philips Semiconductors reserves the right to change the specification without notice, in order to improve the design and supply the best possible product
Product data	Production	This data sheet contains data from the product specification. Philips Semiconductors reserves the right to make changes at any time in order to improve the design, manufacturing and supply. Changes will be communicated according to the Customer Product/Process Change Notification (CPCN) procedure SNW-SQ-650A
Limiting values		
Limiting values are given in accordance with the Absolute Maximum Rating System (IEC 134). Stress above one or more of the limiting values may cause permanent damage to the device. These are stress ratings only and operation of the device at these or at any other conditions above those given in the Characteristics sections of this specification is not implied. Exposure to limiting values for extended periods may affect device reliability.		
Application information		
Where application information is given, it is advisory and does not form part of the specification.		
© Philips Electronics N.V. 2003		
All rights are reserved. Reproduction in whole or in part is prohibited without the prior written consent of the copyright owner.		
The information presented in this document does not form part of any quotation or contract, it is believed to be accurate and reliable and may be changed without notice. No liability will be accepted by the publisher for any consequence of its use. Publication thereof does not convey nor imply any license under patent or other industrial or intellectual property rights.		

LIFE SUPPORT APPLICATIONS

These products are not designed for use in life support appliances, devices or systems where malfunction of these products can be reasonably expected to result in personal injury. Philips customers using or selling these products for use in such applications do so at their own risk and agree to fully indemnify Philips for any damages resulting from such improper use or sale.

³ Please consult the most recently issued datasheet before initiating or completing a design.

⁴ The product status of the device(s) described in this datasheet may have changed since this datasheet was published. The latest information is available on the Internet at URL <http://www.semiconductors.philips.com>.