

IEC Appliance Inlet C14 with Filter, Circuit Breaker TA45 (recessed)

Standard- or Medical-Filter



V-Lock



Description

- Panel Mount:
Screw-on mounting from front side
- 3 Functions:
Appliance Inlet Protection class I, circuit breaker type TA45 2-pole, Line filter in standard and medical version
- Quick connect terminals 6.3 x 0.8 mm

Approvals

- VDE Certificate Number: 40012935
- UL File Number: E72928

Characteristics

- All single elements are already wired
- Line switch non-illuminated or illuminated
Thermal overload protection
Optional with undervoltage- or remote trip release
- Qualified for use in equipment according IEC/EN 60950

Other versions on request

- Unwired versions
- Line switch 1-pole
- Other rocker marking
- Medical version M80
- Capacitance CX1
- Variant with notch for V-Lock mating Cordsets

References

Alternative: version without line filter [DF11](#)
Substitute for type [5145](#)

Weblinks

[General Product Information](#), [Approvals](#), [RoHS](#), [CHINA-RoHS](#), [Mating Connectors](#), [e-Store](#), [SCHURTER-Stock-Check](#), [Distributor-Stock-Check](#), [Accessories](#)

Newly available variants corresponding to V-Lock mating cordset. The connector is equipped with a notch intended for use with the latching cordset. The cord latching system prevents against accidental removal of the cordset.

Technical Data

Ratings IEC	1 - 10A @ Ta 40 °C / 250VAC; 50Hz
Ratings UL/CSA	1 - 15A @ Ta 40 °C / 250VAC; 60Hz
Leakage Current	standard < 0.5 mA (250 V / 60Hz) medical < 5 µA (250 V / 60 Hz)
Dielectric Strength	> 1.7 kVDC between L-N > 2.7 kVDC between L/N-PE Test voltage (2 sec)
Allowable Operation Temp.	-10 °C to 55 °C
Climatic Category	10/055/21 acc. to IEC 60068-1
Degree of Protection	from front side IP 40 acc. to IEC 60529
Protection Class	Suitable for appliances with protection class 1 acc. to IEC 61140
Terminal	Quick connect terminals 6.3 x 0.8 mm
Panel Thickness s	Screw: max 8 mm Mounting screw torque max 0.5 Nm
Material: Housing	Thermoplastic, black, UL 94V-0

Appliance-Inlet/-Outlet	C14 acc. to IEC/EN 60320-1 UL 498, CSA C22.2 no. 42 (for cold conditions) pin-temperature 70 °C, 10A, Protection Class 1
Circuit Breakers	Acc. IEC/EN 60934, UL 1077, CSA 22.2 no. 235 2-pole rocker switch, illuminated or non-illuminated. Optional with undervoltage- or remote trip release Short circuit capacity Icn: at In < 3A/240VAC : 10 x In at In ≥ 3A/240VAC : 300A
Line Switch	Rocker switch 2-pole non-illuminated or illuminated acc. to IEC 61058-1 Technical details
Line Filter	Standard and Medical Version, IEC 60939, IEC 60601-1, UL 1283, UL 544, EN 133 200, CSA C22.2 no. 8 Technical details
MTBF	> 100'000h acc. to MIL-HB-217 F

Dimensions

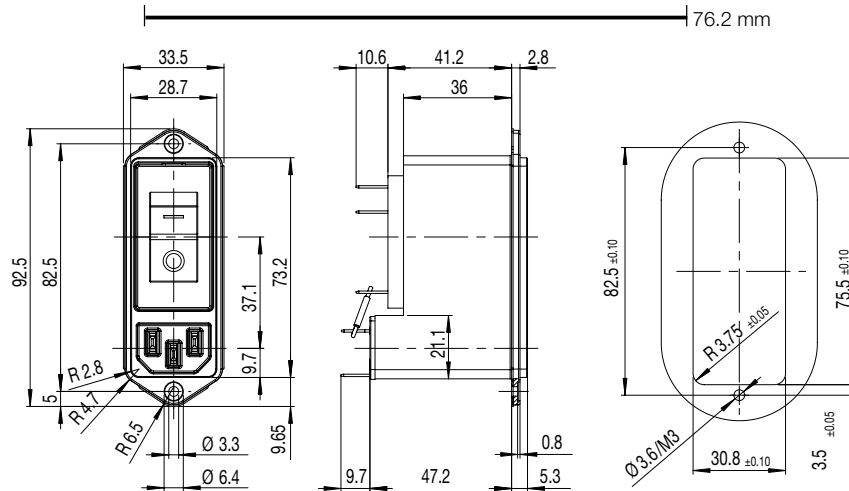

* Version TA45 with undervoltage release

Technical Data of Filter-Components

Rated Current [A]	Filter-Type	Inductances L [mH]	Capacitance CX [nF]	Capacitance CY [nF]	R [MΩ]
1	Standard Version	2 x 11	100	2.2	1
2	Standard Version	2 x 4	100	2.2	1
3	Standard Version	2 x 2.5	100	2.2	1
4	Standard Version	2 x 1.6	100	2.2	1
6	Standard Version	2 x 0.7	100	2.2	1
8	Standard Version	2 x 0.6	100	2.2	1
10	Standard Version	2 x 0.4	100	2.2	1
15	Standard Version	2 x 0.1	100	2.2	1
1	Medical Version (M5)	2 x 11	100	-	1
2	Medical Version (M5)	2 x 4	100	-	1
3	Medical Version (M5)	2 x 2.5	100	-	1
4	Medical Version (M5)	2 x 1.6	100	-	1
6	Medical Version (M5)	2 x 0.7	100	-	1
8	Medical Version (M5)	2 x 0.6	100	-	1
10	Medical Version (M5)	2 x 0.4	100	-	1
15	Medical Version (M5)	2 x 0.1	100	-	1

Diagrams

Standard version

Medical version

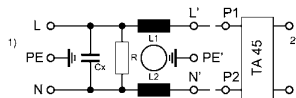
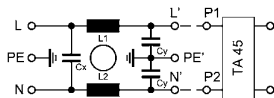

1) Line
2) Load

1) Line
2) Load

Table 1 Selection for type TA45

Order example



- Line switch
 - 2-pole, rocker actuated
 - Quick connect terminal
- Other types on request

ABT W F 150 C0

Diagram

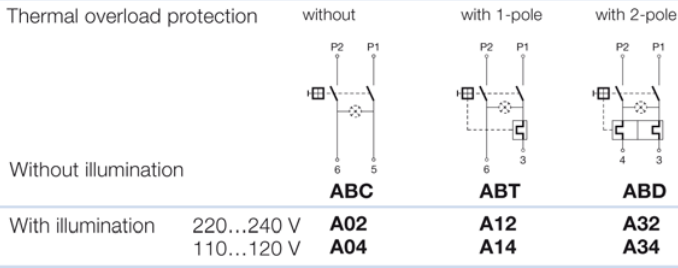

Colours

Switch front	Rocker	
W black	white	—
B black	black	—
6 black	—	orange transp.

Rocker legend

Surface	Illustration	Colour of print	Surface	Illustration	Colour of print
F embossed / Relief	— ○		M printed	— ○	black
H printed / bedruckt	ON OFF	white / weiss	P printed	I ○	white
K printed / bedruckt	ON OFF	black / schwarz	R printed	I ○	black
L printed / bedruckt	— ○	white / weiss			

Position of the rocker legend
e.g F

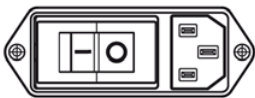

Rated current:

- Without thermal overload protection: code C00 } $I_n = 20\text{ A}$
- With thermal overload protection: rated current I_n (A)

I_n	Code	I_n	Code	I_n	Code	I_n	Code
0,1	J01	1,3	J13	2,8	J28	10,0	100
0,2	J02	1,4	J14	3,0	030	11,0	110
0,3	J03	1,5	J15	3,5	035	12,0	120
0,4	J04	1,6	J16	4,0	040	13,0	130
0,5	J05	1,7	J17	4,5	045	14,0	140
0,6	J06	1,8	J18	5,0	050	15,0	150
0,7	J07	1,9	J19	6,0	060		
0,8	J08	2,0	J20	6,5	065		
0,9	J09	2,1	J21	7,0	070		
1,0	J10	2,2	J22	7,5	075		
1,1	J11	2,3	J23	8,0	080		
1,2	J12	2,5	J25	9,0	090		

Without release: code C0

Undervoltage release

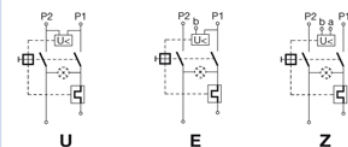

•	•	•
•	•	•
•	•	•

Remote trip release

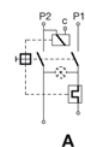

Code	Rated voltage U_n
• 2	240 V AC
• 3	230 V AC
• 4	120 V AC

Technical data (continued)

Circuit breaker

Tripping characteristics

$I_n < 3 A$

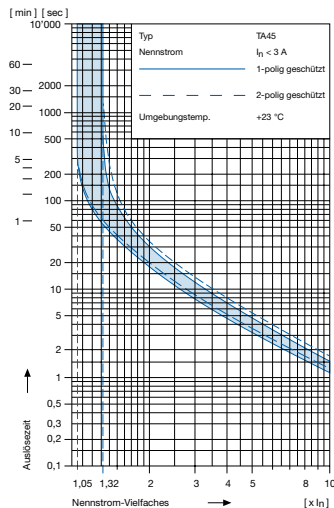

Tripping characteristics

$I_n \ge 3... \le 15 A$

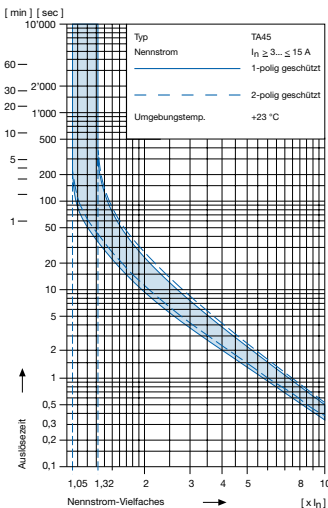

Effect of ambient temperature ¹⁾

The unit is calibrated for an ambient temperature of +23 °C. To determine the rated current for a lower or higher ambient temperature, use a correction factor from the table below.

* Ambient temperature [°C] Correction factor

-10	0,89
- 5	0,91
0	0,92
+23	1,00
+30	1,03
+40	1,08
+55	1,16

* Temperature must be measured at the rear of the breaker next to the terminals after equipment operating temperature has been reached.

1) Example

Rated current at +23 °C	6,0 A
Ambient temperature	+40 °C
Correction factor	1,08
Chosen rated current at + 40 °C ambient temperature	6 A x 1,08 = 6,5 A

Order code (Order example)

Type	Order code TA 45 (2-pole rocker-switch without accessories)
-------------	---

DF12.	A	B	T	W	F	1	5	0	C	0	.	0	0	1	0	.	1
	see table 1																

- Wiring**
- 1 wired
- 2 unwired
- Mounting**
- 0 Screw
- Terminals**
- 1 Quick connect 6.3 x 0.8
- Filter Version**
- 1 Standard
- 3 Medical M5
- Rated Current Filter**
- 1 = 1A 5 = 6A
- 2 = 2A 6 = 8A
- 3 = 3A 7 = 10A
- 4 = 4A 9 = 15A

Please note that Schurter will establish an internal part number for logistical use in addition to the order code. The format of this internal part number is, for example DF12.xxxxxx

Packaging unit 20 Pcs

Accessories

Description

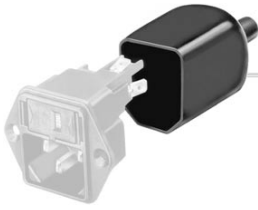

Assorted Covers
Rear Cover

0859.0109

Mating Outlets/Connectors

Category / Description

Appliance Outlet Overview complete



IEC Appliance Outlet F, Screw-on Mounting, Front Side, Solder Terminal	4787
IEC Appliance Outlet F, Snap-in Mounting, Front Side, Solder or Quick-connect Terminal	4788
IEC Appliance Outlet F or H, Screw-on Mounting, Front Side, Solder, PCB or Quick-connect Terminal	5091
IEC Appliance Outlet F or H, Screw-on Mounting, Front Side, Solder or Quick-connect Terminal	5092

[Appliance Outlet further types to DF12](#)

Connector Overview complete



IEC Connector C15, Rewireable, Straight	0101
IEC Connector C15A, Rewireable, Straight	0102
IEC Connector C15A, Rewireable, Straight	0102-G
IEC Connector C15A, Rewireable, Angled	0112
IEC Connector C13, Rewireable, Angled	4012

[Connector further types to DF12](#)

...

Power Cord Overview complete



Power Cord with IEC Connector C13, Angled	0311
Power Cord with IEC Connector C13, Angled	3011
Power Cord with IEC Connector C13, Angled	3012
Power Cord with IEC Connector C13, Angled	3013
Power Cord with IEC Connector C13	3020

[Power Cord further types to DF12](#)

...