







# XDSL SPLITTER FILTER MODULE



-  POTS Central Office Splitter for standard ADSL applications
-  For use with applications under BT-SIN-346 standard
-  This module is part of a standard series which has footprint compatibility
-  Patent pending
-  ADSL2+ compatible
-  NL version: RoHS-6 compliant

## Electrical Specifications @ 25°C

PARAMETER	FREQUENCY	
POTS Impedance	100 Hz to 4 kHz	320 Ω + 1050 Ω / 230 nF
POTS Insertion Loss	1 kHz	-1.0 dB MAX
POTS Attenuation Distortion relative to 1kHz	200 Hz to 3.4 kHz	±1.0 dB MAX
POTS Return Loss	200 Hz to 2 kHz	-18 dB MIN
	2 kHz to 3.4 kHz	-14 dB MIN
POTS Delay Distortion	600 Hz to 4 kHz	200 μSec MAX
Longitudinal Balance	100 Hz to 3.4 kHz	-52 dB MIN
ADSL Insertion Loss	32 kHz to 200 kHz	-29 dB MIN
	200 kHz to 2.2 MHz	-55 dB MIN
DC Current		100 mA MAX
Total DC Resistance		50 Ω MAX
For Information - behavior at VDSL frequencies: ADSL Insertion Loss	2.2 MHz to 12 MHz	-40 dB MIN
	12 MHz to 30 MHz	-30 dB MIN

## Mechanical

### B8046NL

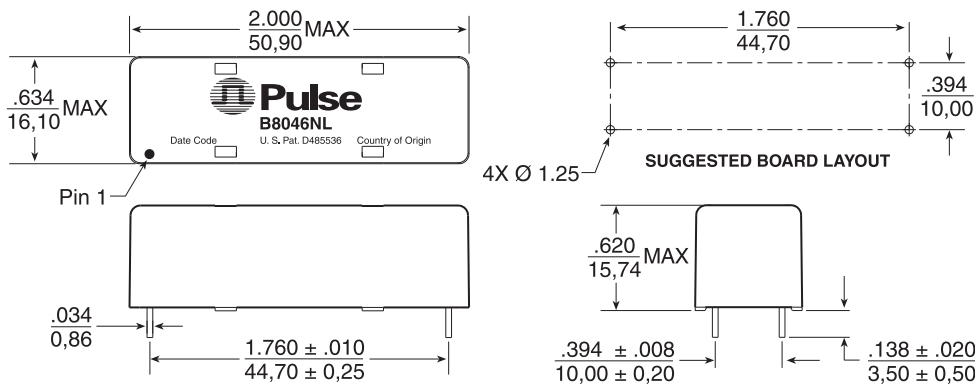

**Weight** ..... 11 grams  
**Tray** ..... 35/tray  
**Dimensions:**  $\frac{\text{Inches}}{\text{mm}}$   
 Unless otherwise specified,  
 all tolerances are  $\pm \frac{.010}{0,25}$

## Schematic

**B8046NL**

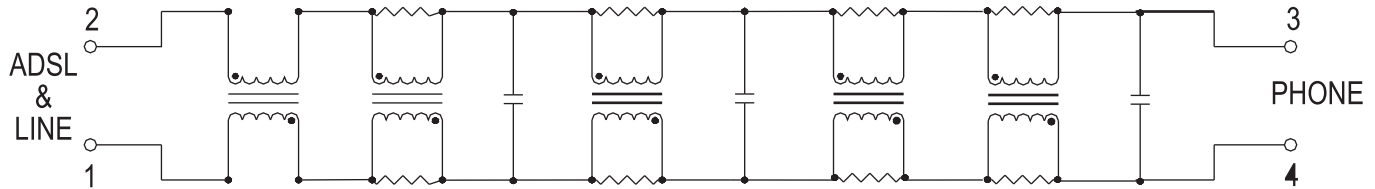

### For More Information:

**Pulse Worldwide Headquarters**  
12220 World Trade Dr.  
San Diego, CA 92128  
U.S.A.  
[www.pulseeng.com](http://www.pulseeng.com)

Tel: 858 674 8100  
Fax: 858 674 8262

**Pulse Europe**  
Zeppelinstrasse 15  
D-71083 Herrenberg  
Germany

Tel: 49 7032 7806 0  
Fax: 49 7032 7806 135

**Pulse China Headquarters**  
B402, Shenzhen Academy of  
Aerospace Technology Bldg.  
10th Kejinan Rd.  
High-Tech Zone  
Nanshan District  
Shenzhen, PR China 518057

Tel: 86 755 33966678  
Fax: 86 755 33966700

**Pulse North China**  
Room 2704/2705  
Super Ocean Finance  
Ctr.  
2067 Yan An Rd. West  
Shanghai 200336  
China

Tel: 86 21 62787060  
Fax: 86 2162786973

**Pulse South Asia**  
135 Joo Seng Rd.  
#03-02  
PM Industrial Bldg.  
Singapore 368363

Tel: 65 6287 8998  
Fax: 65 6287 8998

**Pulse North Asia**  
3F, No. 198  
Zhongyuan Rd.  
Zhongli City  
Taoyuan County 320  
Taiwan R. O. C.

Tel: 886 3 4356768  
Fax: 886 3 4356823 (Pulse)  
Fax: 886 3 4356820 (FRE)

Performance warranty of products offered on this data sheet is limited to the parameters specified. Data is subject to change without notice. Other brand and product names mentioned herein may be trademarks or registered trademarks of their respective owners.

© Copyright, 2010. Pulse Engineering, Inc. All rights reserved.