

EMI Noise Filters

KNF 32 Series

Features

- 1) Stable attenuation without ringing with distributed parameter circuit
- 2) Low profile (1mm, 0.04 in) 1206 type
- 3) Simple construction

Applications

- 1) Personal computers, LBP
:Clock output (signal) line
:I/O line (ex. video signal line such as VGA, XGA)
- 2) Digital cellular phones
- 3) Other high speed digital circuits, for example digital TV, VTR

How To Order

KNF 32 050 -W 2

- ① Series
- ② Size: 32=1206, 21=0805
- ③ Type (Freq.): 025=25MHz, 050=50MHz
100=100MHz, 200=200MHz
0805: 050=50MHz, 100=100MHz
200=200MHz, 400=400MHz

- ④ Taping direction (X, Y)

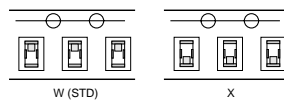

- ⑤ Quantity per reel:
2=2000p, 3=3000p

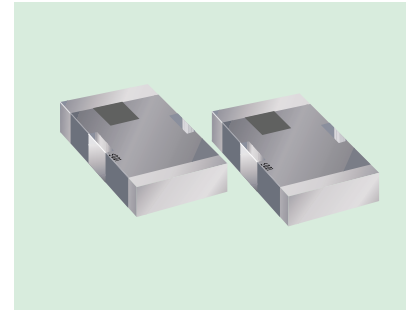

Shape and Dimensions

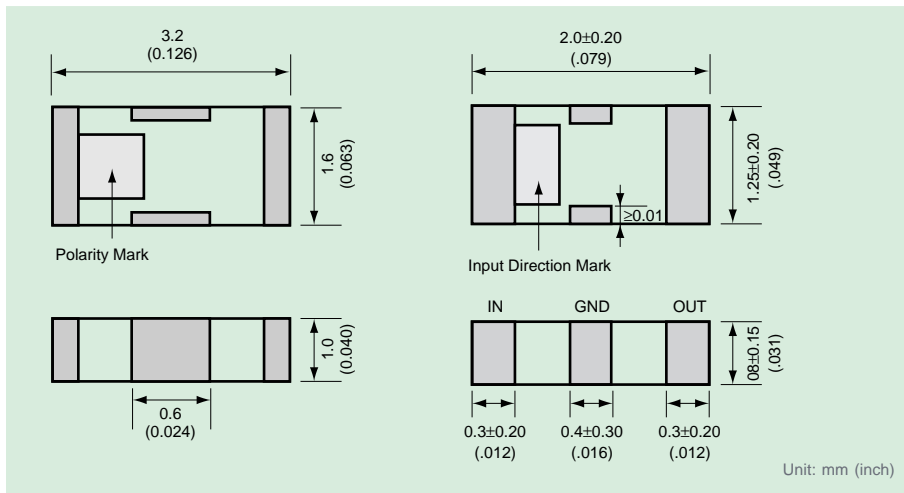

Equivalent Circuit

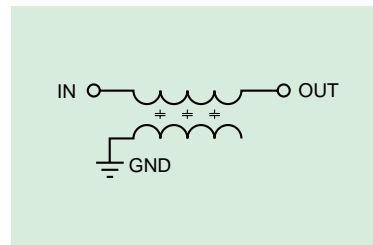

Specifications

Type	Cut off Freq.	Capacitance (+50/-20%)	Typical Attenuation (dB)
KNF32025	25MHz	235pF	20 (200-600MHz)
KNF32050	50MHz	130pF	20 (350-850MHz)
KNF32100	100MHz	65pF	20 (450-950MHz)
KNF32200	200MHz	33pF	20 (600-1100MHz)
KNF21050	50MHz	130pF	20 (350-850MHz)
KNF21100	100MHz	65pF	20 (450-950MHz)
KNF21200	200MHz	33pF	20 (700-1200MHz)
KNF21400	400MHz	17pF	20 (900-1400MHz)

Rated voltage: 25VDC
 Rated current: 200mA
 Attenuation of cut off frequency: max. -6dB
 Attenuation characteristics should be standard characteristics of 50Ω (MIL-STD-220A)

Performance Characteristics

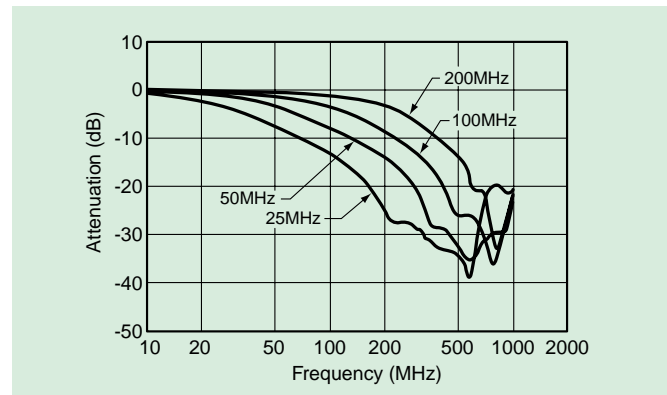

EMI Noise Filters

KNF 32 Series

Typical Example of Suppression

KC KNF32050

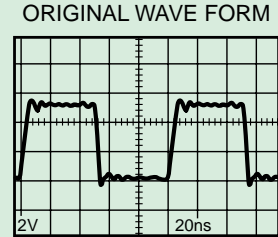
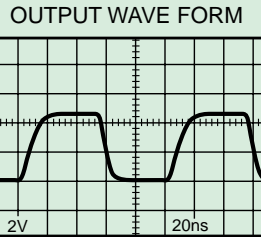
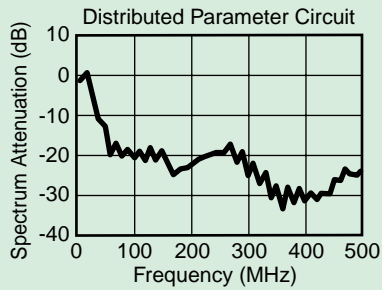

LC Filter

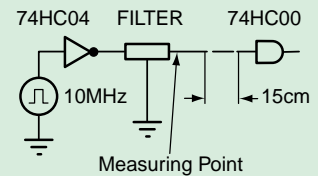
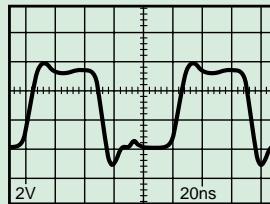
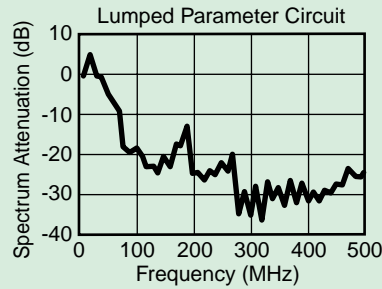

Land Pattern

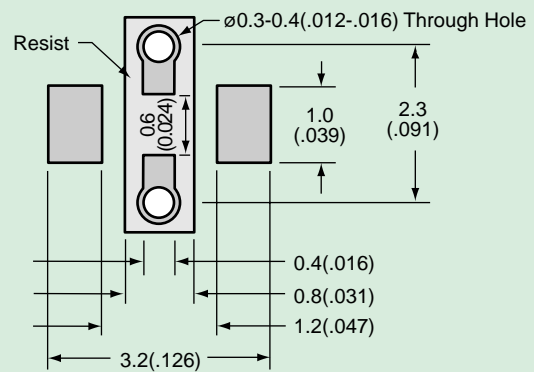
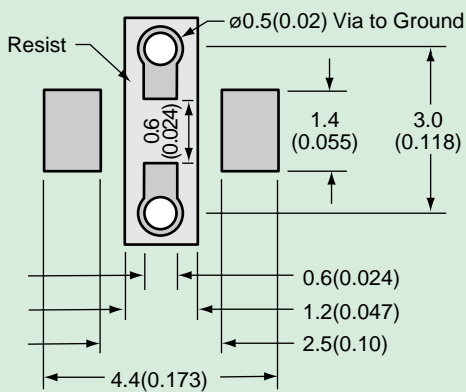

Unit: mm (inch)