

Main features

Symbol	Value	Unit
$I_{T(RMS)}$	4	A
V_{DRM}/V_{RRM}	600 to 800	V
$I_{GT}(Q_1)$	3 to 25	mA

Description

The **Z04** series is suitable for general purpose AC switching applications. They can be found in applications such as home appliances (electrovalve, pump, door lock, small lamp control), fan speed controllers,...

Different gate current sensitivities are available, allowing optimized performances when controlled directly from microcontrollers.

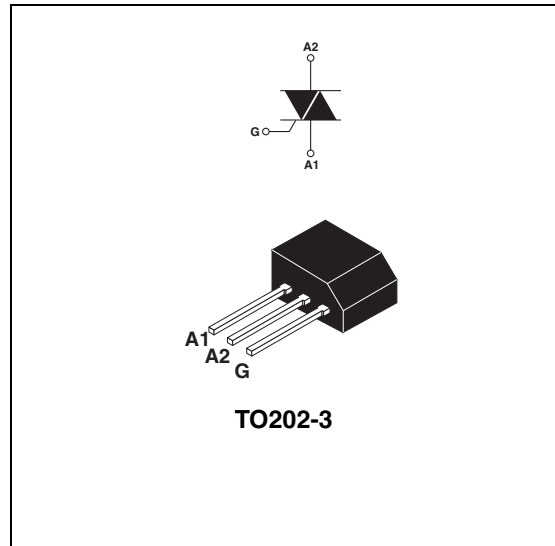
Order codes

Part Number	Marking
Z04xxyF ⁽¹⁾	Z04xxyF ⁽¹⁾

1. xx = sensitivity, y = voltage

Table 1. Absolute maximum ratings

Symbol	Parameter		Value	Unit
$I_{T(RMS)}$	RMS on-state current (full sine wave)	$T_{amb} = 25^{\circ}C$	4	A
		$T_j = 30^{\circ}C$		
I_{TSM}	Non repetitive surge peak on-state current (full cycle, T_j initial = $25^{\circ}C$)	F = 50 Hz t = 20 ms	20	A
		F = 60 Hz t = 16.7 ms	21	
I^2t	I^2t Value for fusing	$t_p = 10$ ms	2.2	A^2s
di/dt	Critical rate of rise of on-state current $I_G = 2 \times I_{GT}$, $t_r \leq 100$ ns	F = 120 Hz $T_j = 125^{\circ}C$	20	A/ μs
I_{GM}	Peak gate current	$t_p = 20$ μs $T_j = 125^{\circ}C$	1.2	A
$P_{G(AV)}$	Average gate power dissipation	$T_j = 125^{\circ}C$	0.2	W
T_{stg} T_j	Storage junction temperature range Operating junction temperature range		- 40 to + 150 - 40 to + 125	$^{\circ}C$

1 Characteristics

Table 2. Electrical Characteristics (T_j = 25° C, unless otherwise specified)

Symbol	Test Conditions	Quadrant		Z04				Unit
				02	05	09	10	
I _{GT} ⁽¹⁾	V _D = 12 V R _L = 30 Ω	I - II - III - IV	MAX .	3	5	10	25	mA
V _{GT}		ALL	MAX .	1.3				V
V _{GD}	V _D = V _{DRM} R _L = 3.3 kΩ T _j = 125° C	ALL	MIN.	0.2				V
I _H ⁽²⁾	I _T = 50 mA		MAX .	3	5	10	25	mA
I _L	I _G = 1.2 I _{GT}	I - III - IV	MAX	6	10	15	25	mA
		II	.	12	15	25	50	
dV/dt ⁽²⁾	V _D = 6 % V _{DRM} gate open T _j = 110° C		MIN.	10	20	100	200	V/μs
(dI/dt) _c ⁽²⁾	(dI/dt) _c = 1.8 A/ms T _j = 110° C		MIN.	0.5	1	2	5	V/μs

1. minimum IGT is guaranteed at 5% of IGT max.

2. for both polarities of A2 referenced to A1.

Table 3. Static Characteristics

Symbol	Test Conditions			Value	Unit	
V _{TM} ⁽¹⁾	I _{TM} = 5.5 A	t _p = 380 μs	T _j = 25° C	MAX.	2.0	V
V _{to} ⁽¹⁾	Threshold voltage		T _j = 125° C	MAX.	0.95	V
R _d ⁽¹⁾	Dynamic resistance		T _j = 125° C	MAX.	180	mΩ
I _{DRM} I _{RDM}	V _{DRM} = V _{RRM}		T _j = 25° C	MAX.	5	μA
			T _j = 125° C		0.5	mA

1. for both polarities of A2 referenced to A1.

Table 4. Thermal resistances

Symbol	Parameter	Value	Unit
R _{th(j-l)}	Junction to lead (AC)	15	° C/W
R _{th(j-a)}	Junction to ambient	100	° C/W

Figure 1. Maximum power dissipation versus RMS on-state current (full cycle)

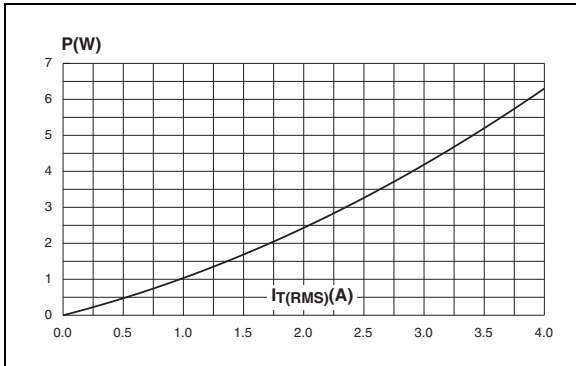

Figure 2. RMS on-state current versus ambient temperature (full cycle)

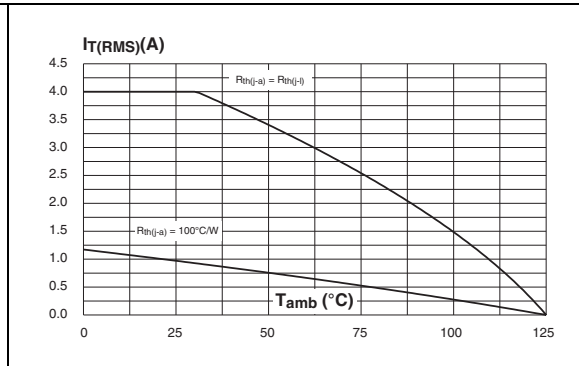

Figure 3. Relative variation of thermal impedance versus pulse duration

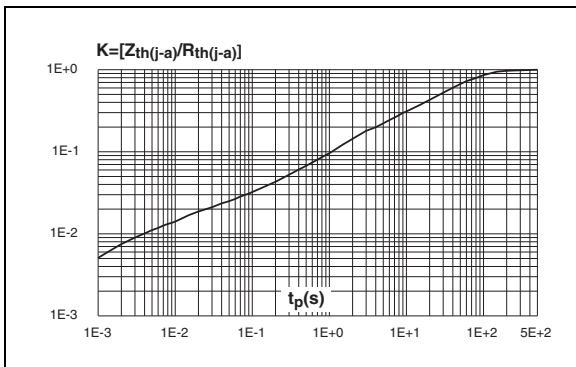

Figure 4. Relative variation of gate trigger current, holding current and latching current versus junction temperature (typical values)

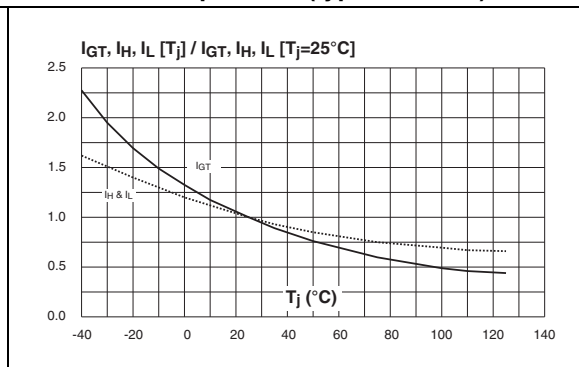

Figure 5. Surge peak on-state current versus number of cycles

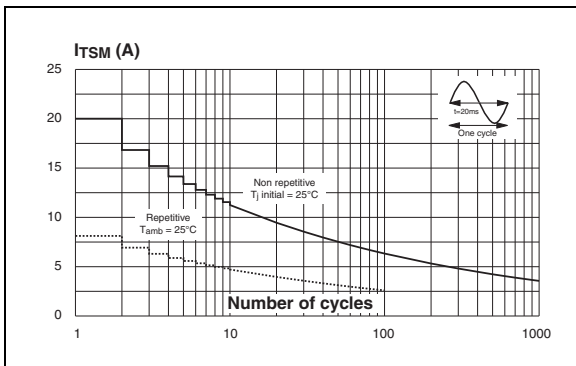

Figure 6. Non-repetitive surge peak on-state current for a sinusoidal pulse with width tp < 10 ms and corresponding value of I²t

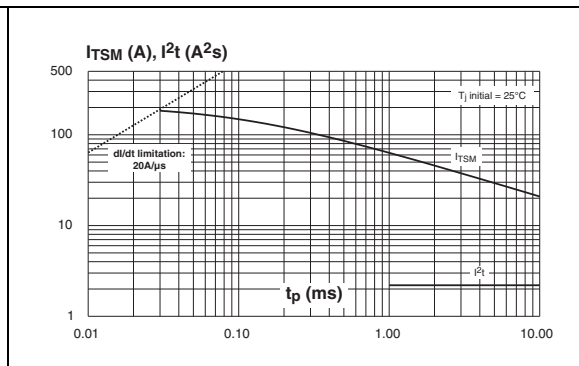

Figure 7. On-state characteristics (maximum values)

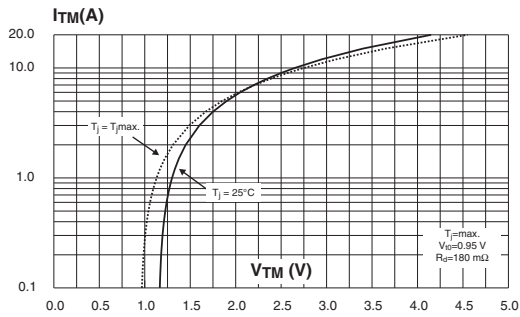

Figure 8. Relative variation of critical rate of decrease of main current versus (dV/dt)_c (typical values)

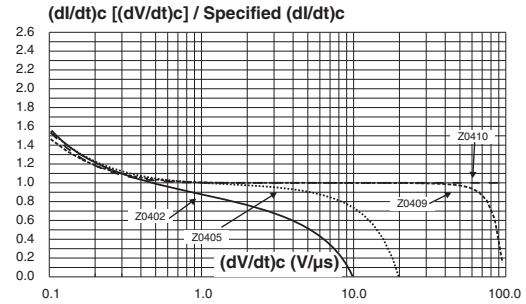
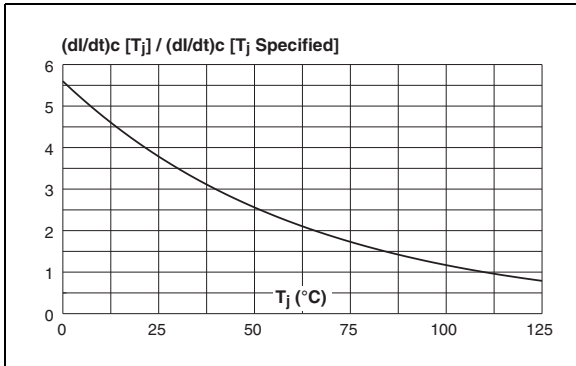

Figure 9. Relative variation of critical rate of decrease of main current versus junction temperature



2 Ordering information scheme

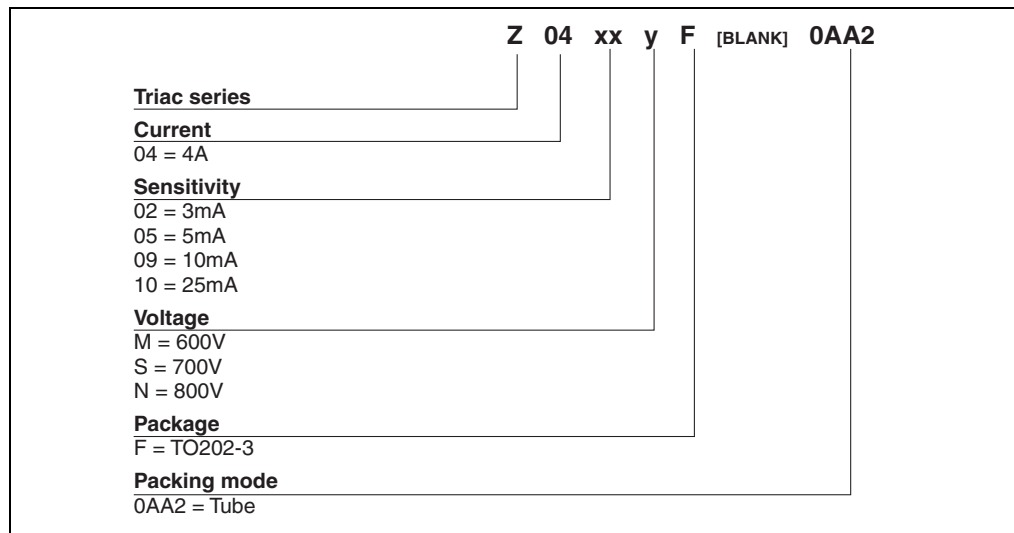

Table 5. Product selector

Part Number	Voltage			Sensitivity	Type	Package
	600 V	700 V	800 V			
Z0402MF	X			3 mA	Standard	TO202-3
Z0402SF		X		3 mA		
Z0402NF			X	3 mA		
Z0405MF	X			5 mA		
Z0405SF		X		5 mA		
Z0405NF			X	5 mA		
Z0409MF	X			10 mA		
Z0409SF		X		10 mA		
Z0409NF			X	10 mA		
Z0410MF	X			25 mA		
Z0410SF		X		25 mA		
Z0410NF			X	25 mA		

3 Package information

REF.	DIMENSIONS					
	Millimeters			Inches		
	Min.	Typ.	Max.	Min.	Typ.	Max.
A			10.1			0.398
C		7.3			0.287	
D		10.5			0.413	
F			1.5			0.059
H		0.51			0.020	
J		1.5			0.059	
M		4.5			0.177	
N			5.3			0.209
N1		2.54			0.100	
O			1.4			0.055
P			0.7			0.028

In order to meet environmental requirements, ST offers these devices in ECOPACK® packages. These packages have a lead-free second level interconnect. The category of second level interconnect is marked on the package and on the inner box label, in compliance with JEDEC Standard JESD97. The maximum ratings related to soldering conditions are also marked on the inner box label. ECOPACK is an ST trademark. ECOPACK specifications are available at: www.st.com.

4 Ordering information

Ordering type	Marking	Weight	Base qty	Delivery mode
Z04xxyF 0AA2 ⁽¹⁾	Z04xxyF ⁽¹⁾	0.8 g	50	Tube

1. xx = sensitivity, y = voltage

5 Revision history

Date	Revision	Description of Changes
Oct-2001	4	Last update.
13-Feb-2006	5	TO202-3 delivery mode changed from bulk to tube. ECOPACK statement added.
31-Mar-2006	6	Reformatted to current standard. Lead marking changed on page 1
12-05-2006	7	Typographical error for (dV/dt) _c corrected in Table 2.

Please Read Carefully:

Information in this document is provided solely in connection with ST products. STMicroelectronics NV and its subsidiaries ("ST") reserve the right to make changes, corrections, modifications or improvements, to this document, and the products and services described herein at any time, without notice.

All ST products are sold pursuant to ST's terms and conditions of sale.

Purchasers are solely responsible for the choice, selection and use of the ST products and services described herein, and ST assumes no liability whatsoever relating to the choice, selection or use of the ST products and services described herein.

No license, express or implied, by estoppel or otherwise, to any intellectual property rights is granted under this document. If any part of this document refers to any third party products or services it shall not be deemed a license grant by ST for the use of such third party products or services, or any intellectual property contained therein or considered as a warranty covering the use in any manner whatsoever of such third party products or services or any intellectual property contained therein.

UNLESS OTHERWISE SET FORTH IN ST'S TERMS AND CONDITIONS OF SALE ST DISCLAIMS ANY EXPRESS OR IMPLIED WARRANTY WITH RESPECT TO THE USE AND/OR SALE OF ST PRODUCTS INCLUDING WITHOUT LIMITATION IMPLIED WARRANTIES OF MERCHANTABILITY, FITNESS FOR A PARTICULAR PURPOSE (AND THEIR EQUIVALENTS UNDER THE LAWS OF ANY JURISDICTION), OR INFRINGEMENT OF ANY PATENT, COPYRIGHT OR OTHER INTELLECTUAL PROPERTY RIGHT.

UNLESS EXPRESSLY APPROVED IN WRITING BY AN AUTHORIZED REPRESENTATIVE OF ST, ST PRODUCTS ARE NOT DESIGNED, AUTHORIZED OR WARRANTED FOR USE IN MILITARY, AIR CRAFT, SPACE, LIFE SAVING, OR LIFE SUSTAINING APPLICATIONS, NOR IN PRODUCTS OR SYSTEMS, WHERE FAILURE OR MALFUNCTION MAY RESULT IN PERSONAL INJURY, DEATH, OR SEVERE PROPERTY OR ENVIRONMENTAL DAMAGE.

Resale of ST products with provisions different from the statements and/or technical features set forth in this document shall immediately void any warranty granted by ST for the ST product or service described herein and shall not create or extend in any manner whatsoever, any liability of ST.

ST and the ST logo are trademarks or registered trademarks of ST in various countries.

Information in this document supersedes and replaces all information previously supplied.

The ST logo is a registered trademark of STMicroelectronics. All other names are the property of their respective owners.

© 2006 STMicroelectronics - All rights reserved

STMicroelectronics group of companies

Australia - Belgium - Brazil - Canada - China - Czech Republic - Finland - France - Germany - Hong Kong - India - Israel - Italy - Japan - Malaysia - Malta - Morocco - Singapore - Spain - Sweden - Switzerland - United Kingdom - United States of America

www.st.com