

EMIFIL® (RC Combined) Single Circuit Type

NFR21G Series (0805 Size)

■ Dimensions

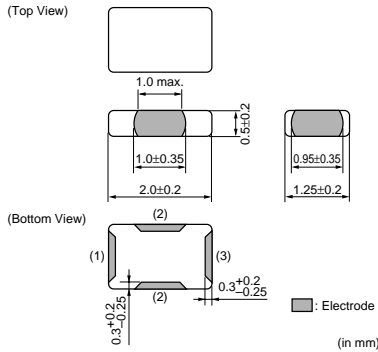

■ Equivalent Circuit

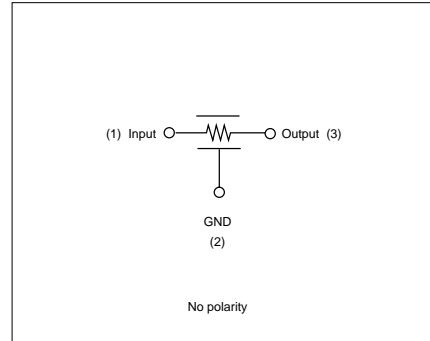

■ Insertion Loss Characteristics (Main Items)

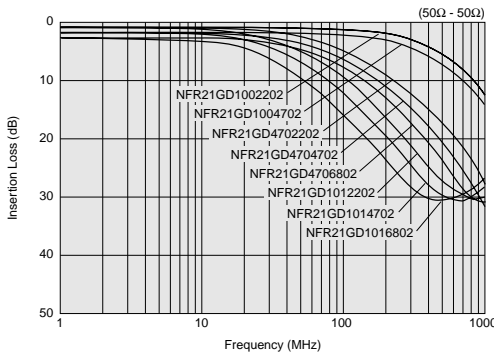

■ Insertion Loss Characteristics (Main Items)

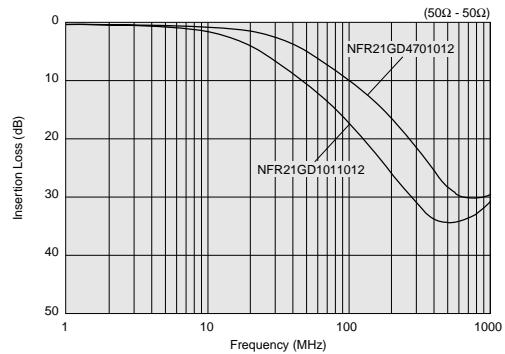

■ Packaging

Code	Packaging	Minimum Quantity
L	180mm Embossed Tape	4000
B	Bulk(Bag)	500

■ Rated Value (□: packaging code)

Part Number	Capacitance	DC Resistance	Rated Current	Rated Voltage	Insulation Resistance (min.)	Operating Temperature Range
NFR21GD1002202□	10pF±20%	22ohm±30%	50mA	50Vdc	1000M ohm	-40 to +85°C
NFR21GD1004702□	10pF±20%	47ohm±30%	35mA	50Vdc	1000M ohm	-40 to +85°C
NFR21GD4702202□	47pF±20%	22ohm±30%	50mA	50Vdc	1000M ohm	-40 to +85°C
NFR21GD4704702□	47pF±20%	47ohm±30%	35mA	50Vdc	1000M ohm	-40 to +85°C
NFR21GD4706802□	47pF±20%	68ohm±30%	30mA	50Vdc	1000M ohm	-40 to +85°C
NFR21GD4701012□	47pF±20%	100ohm±30%	25mA	50Vdc	1000M ohm	-40 to +85°C

Number of Circuit: 1





Continued on the following page.

● This data sheet is applied for RC Combined CHIP EMIFIL® used for General Electronics equipment for your design.

⚠ Note:

1. This datasheet is downloaded from the website of Murata Manufacturing co., Ltd. Therefore, it's specifications are subject to change or our products in it may be discontinued without advance notice. Please check with our sales representatives or product engineers before ordering.
2. This datasheet has only typical specifications because there is no space for detailed specifications. Therefore, please approve our product specifications or transact the approval sheet for product specifications before ordering.

 Continued from the preceding page.

Part Number	Capacitance	DC Resistance	Rated Current	Rated Voltage	Insulation Resistance (min.)	Operating Temperature Range
NFR21GD1012202 	100pF±20%	22ohm±30%	50mA	50Vdc	1000M ohm	-40 to +85°C
NFR21GD1014702 	100pF±20%	47ohm±30%	35mA	50Vdc	1000M ohm	-40 to +85°C
NFR21GD1016802 	100pF±20%	68ohm±30%	30mA	50Vdc	1000M ohm	-40 to +85°C
NFR21GD1011012 	100pF±20%	100ohm±30%	25mA	50Vdc	1000M ohm	-40 to +85°C

Number of Circuit: 1

■ ⚠ Caution/Notice

⚠ Caution (Rating)

Do not use products beyond the rated current and rated voltage as this may create excessive heat and deteriorate the insulation resistance.

Notice

Solderability of Tin plating termination chip might be deteriorated when low temperature soldering profile where peak solder temperature is below the Tin melting point is used. Please confirm the solderability of Tin plating termination chip before use.

● This data sheet is applied for RC Combined CHIP EMIFIL® used for General Electronics equipment for your design.

⚠ Note:

1. This datasheet is downloaded from the website of Murata Manufacturing co., Ltd. Therefore, it's specifications are subject to change or our products in it may be discontinued without advance notice. Please check with our sales representatives or product engineers before ordering.
2. This datasheet has only typical specifications because there is no space for detailed specifications. Therefore, please approve our product specifications or transact the approval sheet for product specifications before ordering.