

Common Mode Filters(SMD) For High-speed Differential Signal Line / General Signal Line

Conformity to RoHS Directive

ACM Series ACM2012, 2520, 3225, 4532 Types

FEATURES

- Although greatly miniaturized, this wire-wound chip-type filter maintains the characteristics needed for a common-mode filter. Common-mode impedance is 1000Ω [at 100MHz], so this filter is greatly effective in supporting noise.
- Almost no affect upon even high speed signals since differential mode impedance is kept low.
- This series includes both 2-line and 3-line types. They are used for various types of circuits and noise.

APPLICATIONS

- Used for radiation noise suppression for any electronic devices.
- Used to counter common-mode noise affecting signals within high speed lines.
- USB line for personal computers and peripheral equipment.
- IEEE1394 line for personal computers, DVC, STB, etc.
- LVDS, panel link line for liquid crystal display panels.

SHAPES AND DIMENSIONS/CIRCUIT DIAGRAMS/ RECOMMENDED PC BOARD PATTERNS

2-LINE TYPE

ACM2012-2P

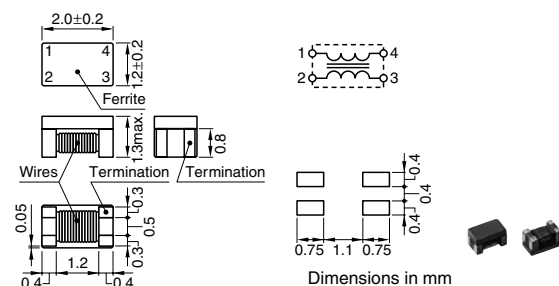

ACM2520-2P

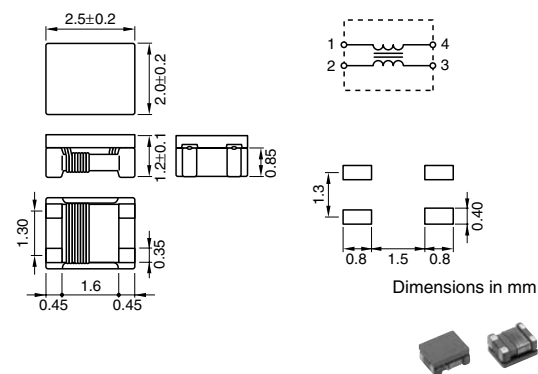

PRODUCT IDENTIFICATION

ACM	2012	-	900	-	2P	-	T	□□□
(1)	(2)	(3)	(4)	(5)	(6)			

- (1) Series name
- (2) Dimensions L×W
2012: 2.0×1.2mm
- (3) Impedance[at 100MHz]
900: 90Ω
- (4) Number of line
2P:2-line
3P:3-line
- (5) Packaging style
T: ø180mm reel taping
TL: ø330mm reel taping
- (6) TDK internal code

TEMPERATURE RANGE

Operating	-25 to +85°C
-----------	--------------

PACKAGING STYLE AND QUANTITIES

Packaging style	Type	Reel	Quantity
Taping	ACM2012	ø180mm	2000 pieces/reel
		ø330mm	10000 pieces/reel
	ACM2520	ø180mm	2000 pieces/reel
		ø330mm	10000 pieces/reel
	ACM3225	ø180mm	1000 pieces/reel
		ø330mm	5000 pieces/reel
ACM4532	ø180mm	500 pieces/reel	
	ø330mm	2000 pieces/reel	

ACM3225-2P

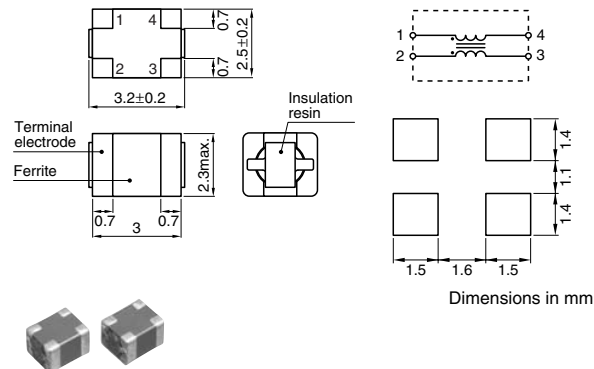

- Conformity to RoHS Directive: This means that, in conformity with EU Directive 2002/95/EC, lead, cadmium, mercury, hexavalent chromium, and specific bromine-based flame retardants, PBB and PBDE, have not been used, except for exempted applications.

• All specifications are subject to change without notice.

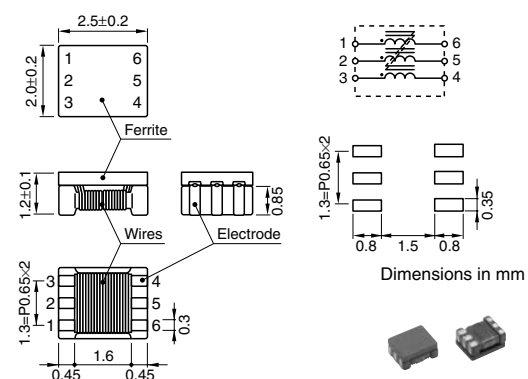
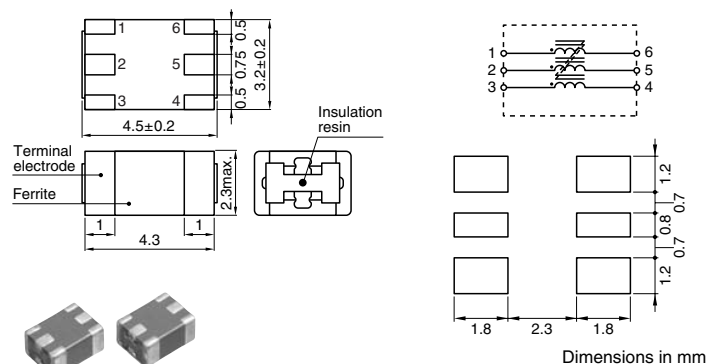
SHAPES AND DIMENSIONS/CIRCUIT DIAGRAMS/RECOMMENDED PC BOARD PATTERNS
3-LINE TYPE
ACM2520-3P

ACM4532-102-3P

ELECTRICAL CHARACTERISTICS

Part No.	Impedance (Ω)typ.[100MHz]	DC resistance (Ω)max.[Per 1 line]	Rated voltage Edc(V)max.	Rated current Idc(A)max.
2-LINE				
ACM2012-900-2P	90	0.19	50	0.4
ACM2012-121-2P	120	0.22	50	0.37
ACM2012-201-2P	200	0.25	50	0.35
ACM2012-361-2P	360	0.5	50	0.22
ACM2520-301-2P	300	0.35	20	0.4
ACM2520-451-2P	450	0.4	20	0.35
ACM2520-601-2P	600	0.45	20	0.3
ACM2520-102-2P	1000	0.9	20	0.2
ACM3225-800-2P	80	0.15	20	0.4
ACM3225-161-2P	160	0.2	20	0.35
ACM3225-271-2P	270	0.3	20	0.3
ACM3225-102-2P	1000	0.5	20	0.2
3-LINE				
ACM2520-801-3P	800	1.6	20	0.15
ACM4532-102-3P	1000	0.6	20	0.2

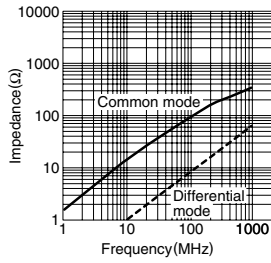
TYPICAL ELECTRICAL CHARACTERISTICS IMPEDANCE vs. FREQUENCY CHARACTERISTICS

ACM2012-900-2P



ACM2012-121-2P

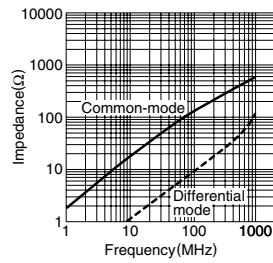

ACM2012-201-2P

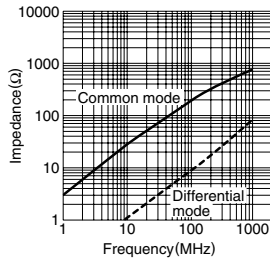

ACM2012-361-2P

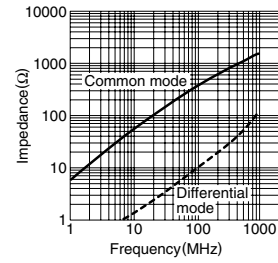

ACM2520-301-2P

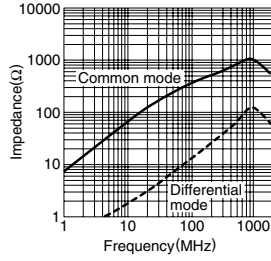

ACM2520-451-2P

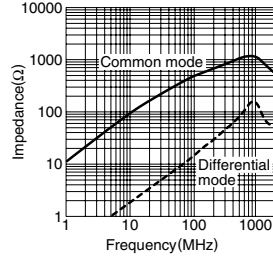

ACM2520-601-2P

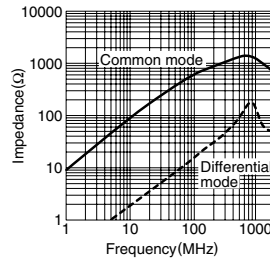

ACM2520-102-2P

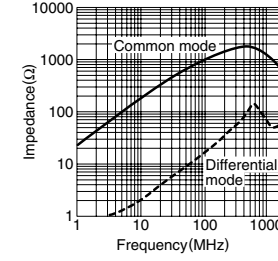

ACM3225-800-2P

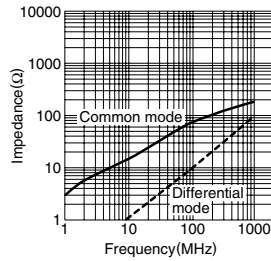

ACM3225-161-2P

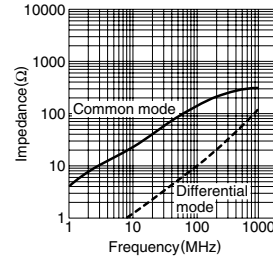

ACM3225-271-2P

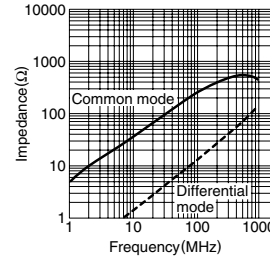

ACM3225-102-2P

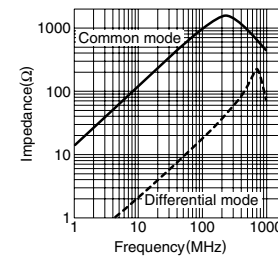

MEASURING CIRCUITS

2-LINE

Common mode

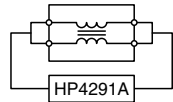

Differential mode

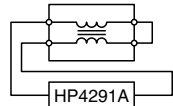

TYPICAL ELECTRICAL CHARACTERISTICS IMPEDANCE vs. FREQUENCY CHARACTERISTICS

ACM2520-801-3P

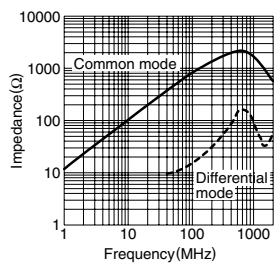

ACM4532-102-3P

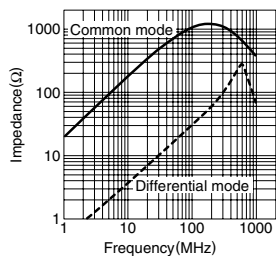

MEASURING CIRCUITS

3-LINE

Common mode

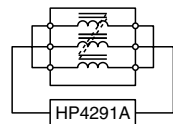

Differential mode

