

8x2 LINE COMMON MODE CHOKES

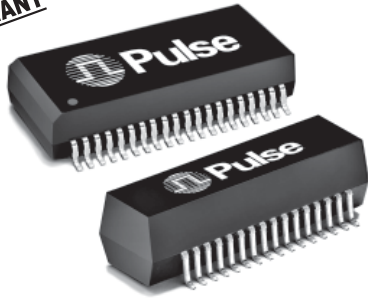

Designed for Quad Port T1/E1 Applications



- RoHS peak reflow temperature rating: 245°C
- For Quad Port T1/E1 applications
- Meets high-performance EMI reduction required for multiplexers, channel routers and ISP servers
- Common mode attenuation from 100 kHz to 500 MHz

Electrical Specifications @ 25°C — Operating Temperature -40°C to +85°C

RoHS-6 Compliant Part Number	Number of Lines	Primary Inductance OCL (μ H MIN)	Common Mode Attenuation (dB TYP)								DCR (Ω MAX)
			100 kHz	1 MHz	10 MHz	30 MHz	50 MHz	100 MHz	300 MHz	500 MHz	
T8008NL	16	47	13	27	40	44	42	36	26	15	0.40
T8132NL	16	47	13	29	43	44	42	35	24	15	0.40

NOTE: When ordering Tape & Reel packaging, add a "T" suffix to the part number (ex:T8008NLT).

Mechanical

Schematic

T8008NL

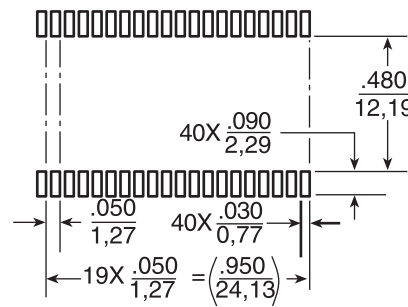
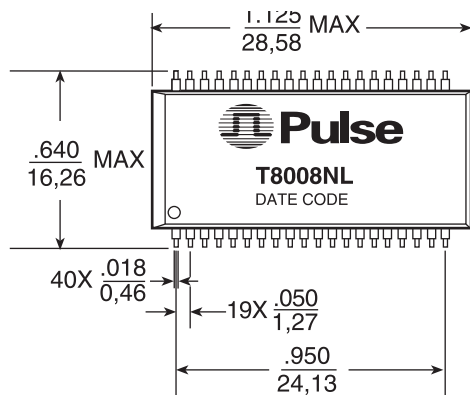

SUGGESTED PAD LAYOUT

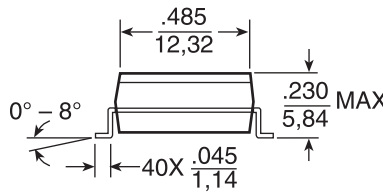
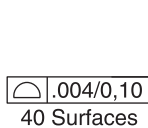
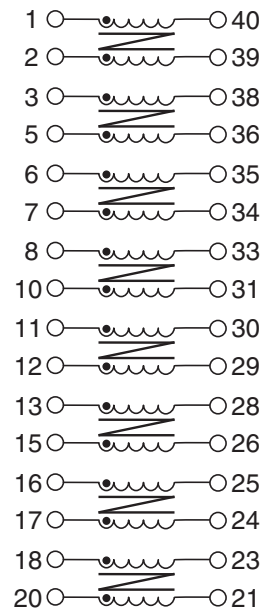

Weight 4.0 grams
Tape & Reel 250/reel
Tube 15/tube

Dimensions: $\frac{\text{Inches}}{\text{mm}}$
Unless otherwise specified, all tolerances are $\pm \frac{.010}{0,25}$

Downloaded from Elcodis.com electronic components distributor

8x2 LINE COMMON MODE CHOKES

Designed for Quad Port T1/E1 Applications



Mechanical

Schematic

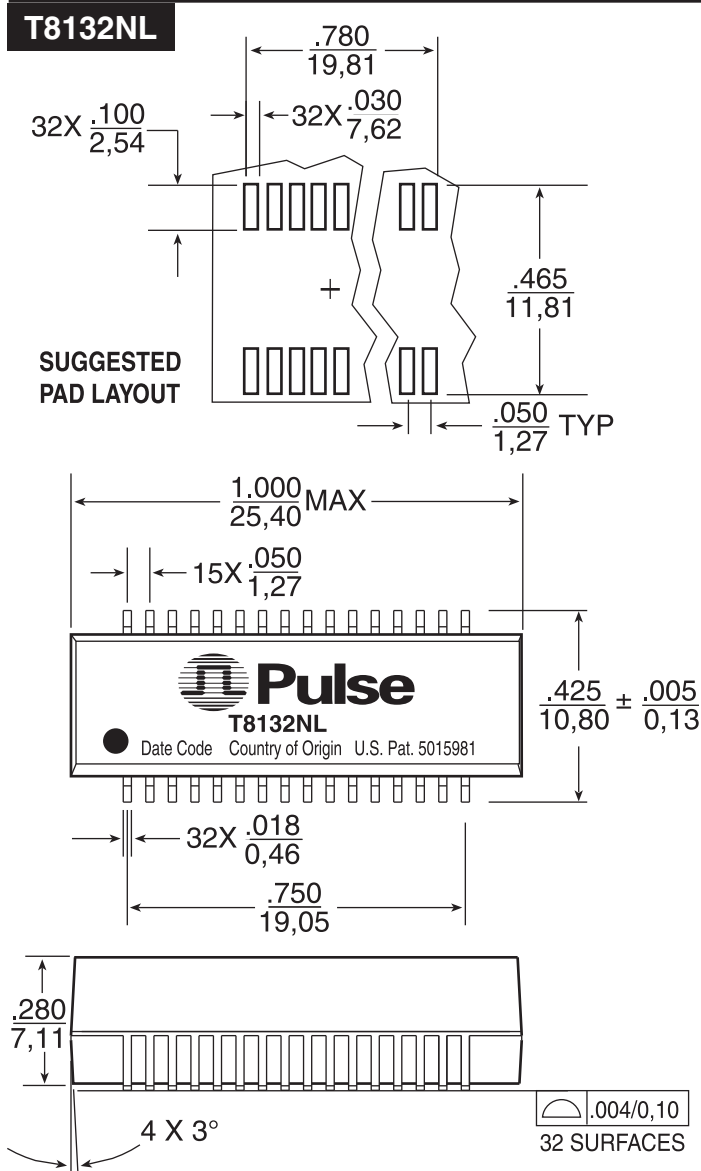

Weight 2.7 grams
Tape & Reel 200/reel
Tube 20/tube

Dimensions: $\frac{\text{Inches}}{\text{mm}}$
Unless otherwise specified,
all tolerances are $\pm \frac{.010}{0.25}$

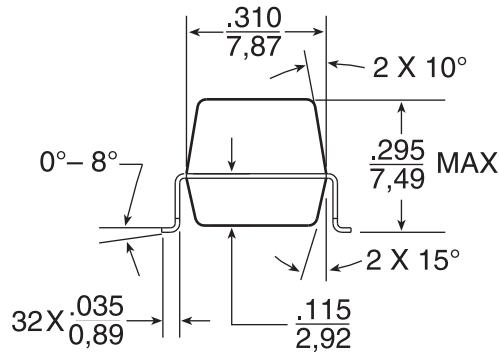
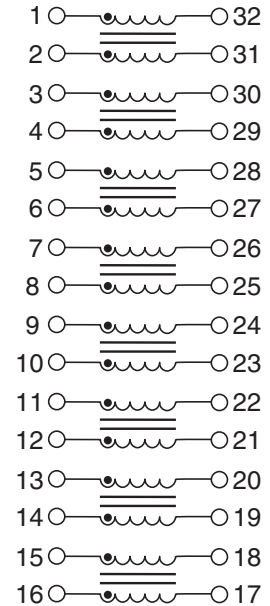

For More Information:

Pulse Worldwide Headquarters
12220 World Trade Dr.
San Diego, CA 92128
U.S.A.

Pulse Europe
Einsteinstrasse 1
D-71083 Herrenberg
Germany

Pulse China Headquarters
B402, Shenzhen Academy of
Aerospace Technology Bldg.
10th Kejinan Rd.
High-Tech Zone
Nanshan District
Shenzhen, PR China 518057
TEL: 86 755 33966678
FAX: 86 755 33966700

Pulse North China
Room 1503
XinYin Building
No. 888 YiShan Rd.
Shanghai 200233
China
Tel: 86 21 54643211/2
Fax: 86 21 54643210

Pulse South Asia
135 Joo Seng Rd.
#03-02
PM Industrial Bldg.
Singapore 368363
TEL: 65 6287 8998
FAX: 65 6280 0080

Pulse North Asia
No. 26, Kao Ching Rd.
Yang Mei Chen
Taoyuan Hsien
Taiwan
R. O. C.
Tel: 886 3 4643715
Fax: 886 3 4641911

www.pulseeng.com
Tel: 858 674 8100
Fax: 858 674 8262

Tel: 49 7032 7806 0
Fax: 49 7032 7806 135

Performance warranty of products offered on this data sheet is limited to the parameters specified. Data is subject to change without notice. Other brand and product names mentioned herein may be trademarks or registered trademarks of their respective owners.

© Copyright, 2009, Pulse Engineering, Inc. All rights reserved.

www.pulseeng.com