





COMMON MODE CHOKES

For DSL and Telecom Applications



-  Family of 2-wire Common Mode Chokes
-  Low profile surface mount package
-  Cost effective construction with Pulse SLIC patented technology
-  Range suited for many DSL and Telecom applications

Electrical Specifications @ 25°C / 80 Vdc — Operating Temperature -40°C to +85°C

Standard Part Number	RoHS-6 Compliant Part Number	OCL (mH +50% / -30%)	L _L (μH TYP)	DCR (Ω MAX)	Current Rating (mAdc)	Isolation (Vrms)
T8116T	T8116NLT	0.47	0.2	0.3	700	500
T8112T	T8112NLT	1.00	0.2	0.3	700	500
T8113T	T8113NLT	2.20	0.25	0.4	500	500
T8114T	T8114NLT	4.70	0.4	0.7	400	500

NOTE: Other custom inductance values available on request. Tube version available for sampling. Please contact Pulse Applications Engineering.

Mechanical

Schematic

PIL

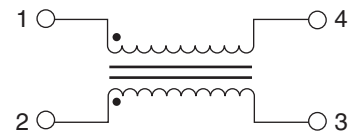
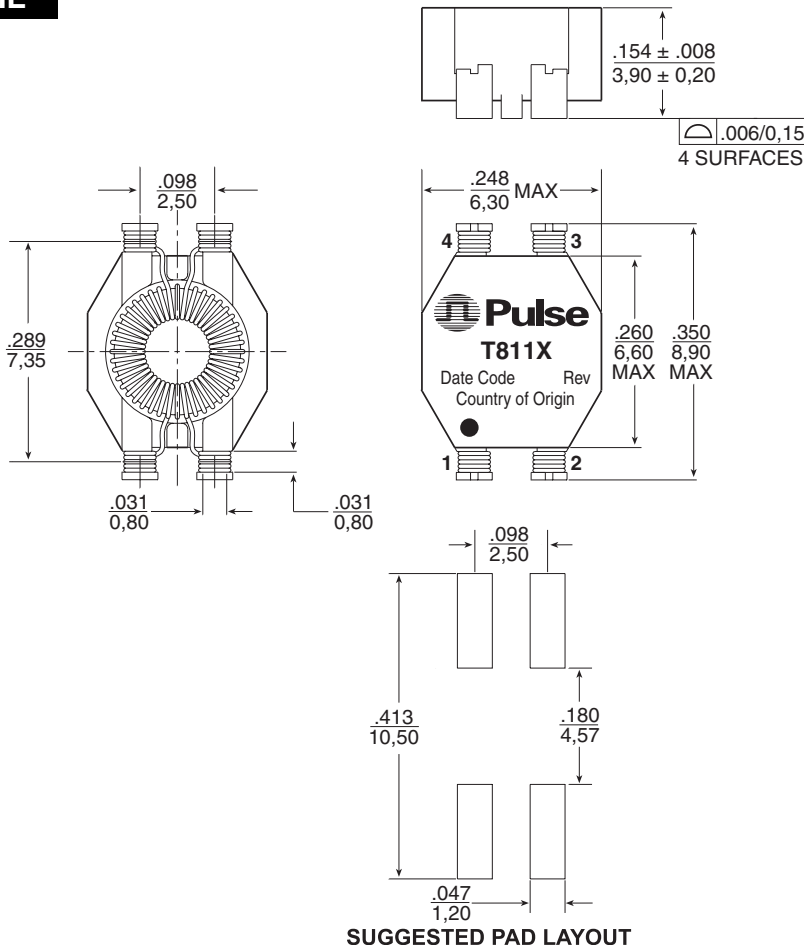

Weight 0.2 grams
 Tape & Reel1600/reel
 Dimensions: Inches
 mm
 Unless otherwise specified,
 all tolerances are ± .010
 0,25

COMMON MODE CHOKES

For DSL and Telecom Applications



Impedance in Common Mode and Differential Mode
T8116 (2 x 0.47mH)

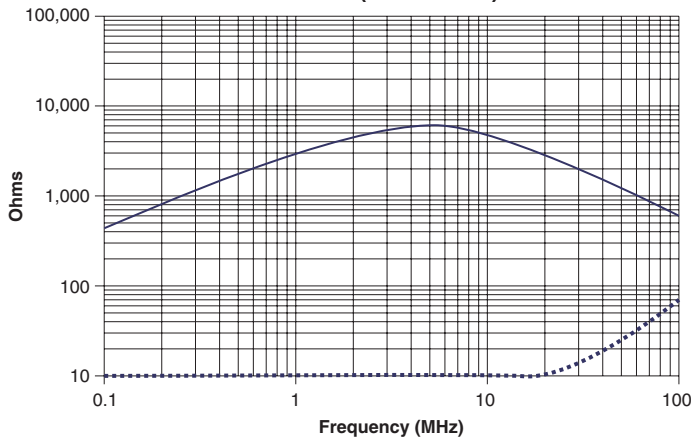

— Common Mode
..... Differential Mode

Impedance in Common Mode and Differential Mode
T8112 (2 x 1mH)

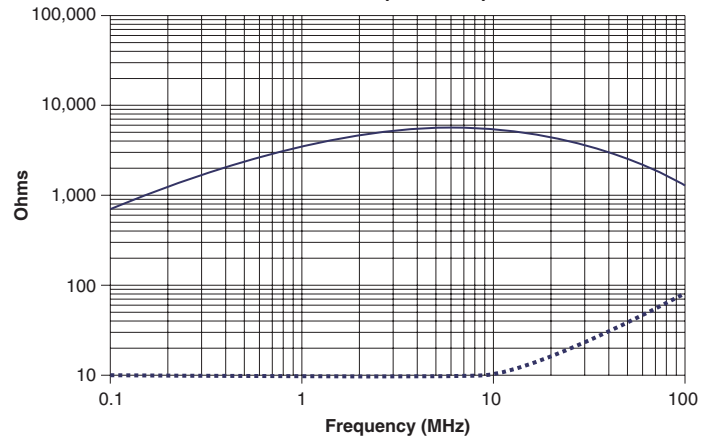

— Common Mode
..... Differential Mode

Impedance in Common Mode and Differential Mode
T8113 (2 x 2.2mH)

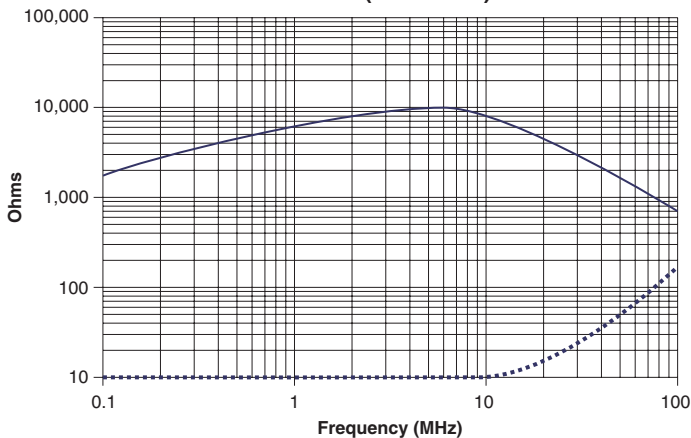

— Common Mode
..... Differential Mode

Impedance in Common Mode and Differential Mode
T8114 (2 x 4.7mH)

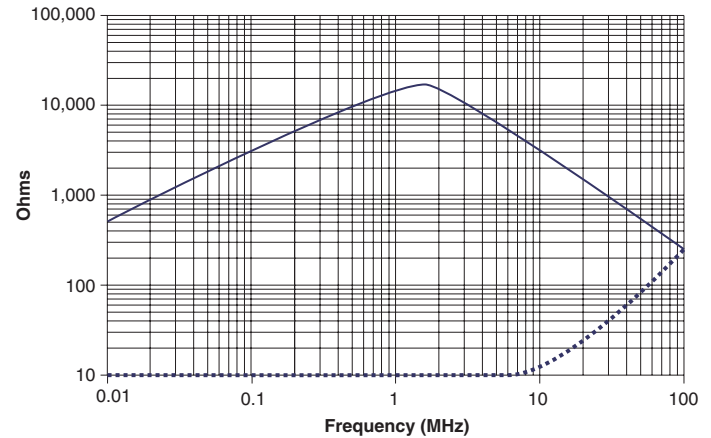

— Common Mode
..... Differential Mode

For More Information:

Pulse Worldwide Headquarters

12220 World Trade Drive
San Diego, CA 92128
U.S.A.

www.pulseeng.com
TEL: 858 674 8100
FAX: 858 674 8262

Pulse Northern Europe

3 Huxley Road
Surrey Research Park
Guildford, Surrey GU2 5RE
United Kingdom

TEL: 44 1483 401700
FAX: 44 1483 401701

Pulse Southern Europe

Zone Industrielle
F-39270
Orgelet
France

TEL: 33 3 84 35 04 04
FAX: 33 3 84 25 46 41

Pulse China Headquarters

No. 1
Industrial District
Changan, Dongguan
China

TEL: 86 769 5538070
FAX: 86 769 5538870

Pulse North China

Room 1503
XinYin Building
No. 888 YiShan Road
Shanghai 200233
China

TEL: 86 21 54643211/2
FAX: 86 21 54643210

Pulse South Asia

150 Kampong Ampat
#07-01/02
KA Centre
Singapore 368324

TEL: 65 6287 8998
FAX: 65 6280 0080

Pulse North Asia

No. 26
Kao Ching Road
Yang Mei Chen
Taoyuan Hsien
Taiwan, R. O. C.

TEL: 886 3 4641811
FAX: 886 3 4641911

Performance warranty of products offered on this data sheet is limited to the parameters specified. Data is subject to change without notice. Other brand and product names mentioned herein may be trademarks or registered trademarks of their respective owners.

© Copyright, 2006. Pulse Engineering, Inc. All rights reserved.

www.pulseeng.com

T673.B (2/06)